

Micro Motion® Model 5700 Transmitters

All Installation Types (Integral, 4-Wire, and 9-Wire)



Emerson Flow customer service

Email:

- Worldwide: flow.support@emerson.com
- Asia-Pacific: APflow.support@emerson.com

Telephone:

North and South America		Europe and Middle East		Asia Pacific	
United States	800-522-6277	U.K.	0870 240 1978	Australia	800 158 727
Canada	+1 303-527-5200	The Netherlands	+31 (0) 318 495 555	New Zealand	099 128 804
Mexico	+41 (0) 41 7686 111	France	0800 917 901	India	800 440 1468
Argentina	+54 11 4837 7000	Germany	0800 182 5347	Pakistan	888 550 2682
Brazil	+55 15 3413 8000	Italy	8008 77334	China	+86 21 2892 9000
Venezuela	+58 26 1731 3446	Central & Eastern	+41 (0) 41 7686 111	Japan	+81 3 5769 6803
		Russia/CIS	+7 495 981 9811	South Korea	+82 2 3438 4600
		Egypt	0800 000 0015	Singapore	+65 6 777 8211
		Oman	800 70101	Thailand	001 800 441 6426
		Qatar	431 0044	Malaysia	800 814 008
		Kuwait	663 299 01		
		South Africa	800 991 390		
		Saudia Arabia	800 844 9564		
		UAE	800 0444 0684		

Contents

Planning	3	Configuring the transmitter with Guided Setup	48
Mounting and sensor wiring	7	Using the Display controls	49
Wiring the channels	25	Available Service Port connection	53
Wiring the power supply	45		
Power up the transmitter	47		

1 Planning

Topics covered in this chapter:

- [About this document](#)
- [Installation checklist](#)
- [Additional considerations for retrofit installations](#)
- [Power requirements](#)

1.1 About this document

The *Model 5700 Transmitters: Quick Installation Guide (QIG)* provides information on planning, mounting, wiring, and initial setup of the transmitter. This guide does not include information on full configuration, maintenance, troubleshooting, or service of the transmitter.

For more information, refer to the *Model 5700 Transmitters: Configuration & Use Manual*. You can access all product documentation online via the Micro Motion product documentation DVD shipped with the product or at www.micromotion.com.

1.2 Installation checklist

- Safety messages are provided throughout this content to protect personnel and equipment. Read each safety message carefully before proceeding to the next step.
- If possible, install the transmitter in a location that will prevent direct exposure to sunlight. The environmental limits for the transmitter may be further restricted by hazardous area approvals.
- If you plan to mount the transmitter in a hazardous area:
 - Verify that the transmitter has the appropriate hazardous area approval. Each transmitter has a hazardous area approval tag attached to the transmitter housing.
 - Ensure that any cable used between the transmitter and the sensor meets the hazardous area requirements.
 - For ATEX/IECEx installations, you must strictly adhere to the safety instructions documented in the ATEX/IECEx approvals documentation available on the Micro Motion Product Documentation DVD shipped with the product or at www.micromotion.com. Be sure to reference this documentation in addition to the information shown in this guide.

- Verify that you have the appropriate cable and required cable installation parts for your installation. For wiring between the transmitter and sensor, verify the maximum cable length does not exceed 1000 ft (300 m).
- Ensure that you use the following cable for the different connections:
 - Twisted-pair instrument cable for all I/O connections
 - Twisted-pair shielded cable for the RS-485 (Channel E) connection
- You can mount the transmitter in any orientation as long as the conduit openings or transmitter display do not point upward.

Installing the transmitter with the conduit openings or transmitter display facing upward risks condensation moisture entering the transmitter housing, which could damage the transmitter.

Following are examples of possible orientations for the transmitter.

Table 1-1: Possible transmitter orientation

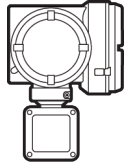
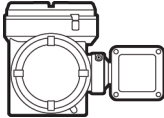
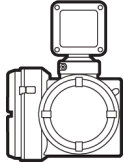
Preferred orientation	Alternate orientations	
		

- Mount the meter in a location and orientation that satisfies the following conditions:
 - Allows sufficient clearance to open the transmitter housing cover. Micro Motion recommends 8–10 inches (200–250 mm) clearance at the wiring access points.
 - Provides clear access for installing cabling to the transmitter.

1.3 Additional considerations for retrofit installations

- The transmitter installation may require 3–6 inches (76–153 mm) of additional wiring for the input/output and power connections. This length would be in addition to the currently installed wiring. Confirm you have the additional wiring necessary for the new installation.
- Before removing the existing transmitter, be sure to record the configuration data for the currently installed transmitter. At initial startup of the newly installed transmitter, you will be prompted to configure the meter via a guided setup.

Micro Motion recommends that you record the following information (if applicable):

Variable	Setting
Tag	
Mass flow units	
Volume flow units	
Density units	
Temperature units	
Channel configuration	
mA output(s)	- Power (Internal or External): - Source: - Scaling (LRV, URV): - Fault Action:
Frequency output(s)	- Power (Internal or External): - Source: - Scaling (LRV, URV): - Fault Action:
Discrete output(s)	- Power (Internal or External): - Source: - Scaling (LRV, URV): - Fault Action:
Discrete input	- Power (Internal or External): - Source: - Scaling (LRV, URV): - Fault Action:
RS-485	- Address:
Calibration parameters (for 9-wire installations only)	
Flow calibration factor	- FCF (Flow Cal or Flow Calibration Factor):
Density calibration factors	- D1: - D2: - K1: - K2: - TC: - FD:

1.4 Power requirements

Self-switching AC/DC input, automatically recognizes supply voltage:

- 85 to 265 VAC, 50/60 Hz, 6 watts typical, 11 watts maximum
- 18 to 100 VDC, 6 watts typical, 11 watts maximum

Note

For DC power:

- Power requirements assume a single transmitter per cable.
- At startup, the power source must provide a minimum of 1.5 amps of short-term current per transmitter.
- Length and conductor diameter of the power cable must be sized to provide 18 VDC minimum at the power terminals, at a load current of 0.7 amps. See *Figure 1-1* and *Table 1-2* for cable sizing guidelines.

Figure 1-1: Cable sizing formula

$$M = 18V + (R \times L \times 0.7A)$$

- *M*: minimum supply voltage
- *R*: cable resistance
- *L*: cable length (in Ω /ft)

Table 1-2: Typical power cable resistance at 68 °F (20 °C)

Wire gauge	Resistance
14 AWG	0.0050 Ω /ft
16 AWG	0.0080 Ω /ft
18 AWG	0.0128 Ω /ft
20 AWG	0.0204 Ω /ft
2.5 mm ²	0.0136 Ω /m
1.5 mm ²	0.0228 Ω /m
1.0 mm ²	0.0340 Ω /m
0.75 mm ²	0.0460 Ω /m
0.50 mm ²	0.0680 Ω /m

1.4.1 Maximum cable lengths between sensor and transmitter

The maximum cable length between the sensor and transmitter that are separately installed is determined by cable type.

Table 1-3: Maximum cable lengths between sensor and transmitter

Cable type	Wire gauge	Maximum length
Micro Motion 4-wire	Not applicable	1000 ft (300 m)
Micro Motion 9-wire	Not applicable	1000 ft (300 m)
User-supplied 4-wire	VDC 22 AWG (0.35 mm ²)	300 ft (90 m)
	VDC 20 AWG (0.5 mm ²)	500 ft (150 m)
	VDC 18 AWG (0.8 mm ²)	1000 ft (300 m)
	RS-485 22 AWG (0.35 mm ²) or larger	1000 ft (300 m)

2 Mounting and sensor wiring

Topics covered in this chapter:

- *Mounting and sensor wiring for integral-mount transmitters*
- *Mount the 4-wire or 9-wire remote-mount transmitters*
- *Wire the 4-wire or 9-wire remote-mount transmitter to the sensor*
- *Ground the meter components*
- *Rotate the transmitter on the sensor (optional)*
- *Rotate the user interface on the transmitter (optional)*
- *Rotate the sensor wiring junction box on a remote-mount transmitter (optional)*

2.1 Mounting and sensor wiring for integral-mount transmitters

There are no separate mounting requirements for integral transmitters, and no need to connect wiring between the transmitter and the sensor.

2.2 Mount the 4-wire or 9-wire remote-mount transmitters

2.2.1 Mount the transmitter to a wall or instrument pole

There are two options available for mounting the transmitter:

- Mount the transmitter to a wall or flat surface.
- Mount the transmitter to an instrument pole.

Prerequisites

- If you are mounting the transmitter to a wall or flat surface:
 - Micro Motion recommends the use of 5/16-18 fasteners that can withstand the process environment. Micro Motion does not supply bolts or nuts as part of the standard offering (general purpose bolts and nuts are available as an option).
 - Ensure that the surface is flat and rigid, does not vibrate, or move excessively.
 - Confirm that you have the necessary tools, and the mounting kit shipped with the transmitter.
- If you are mounting the transmitter to an instrument pole:

- Ensure that the instrument pole extends at least 12 inches (305 mm) from a rigid base, and is no more than 2 inches (50.8 mm) in diameter.
- Confirm that you have the necessary tools, and the instrument-pole mounting kit shipped with the transmitter.

Procedure

1. Attach the mounting bracket to the transmitter and tighten the screws to 80-90 in-lbs.

Figure 2-1: Mounting bracket to transmitter

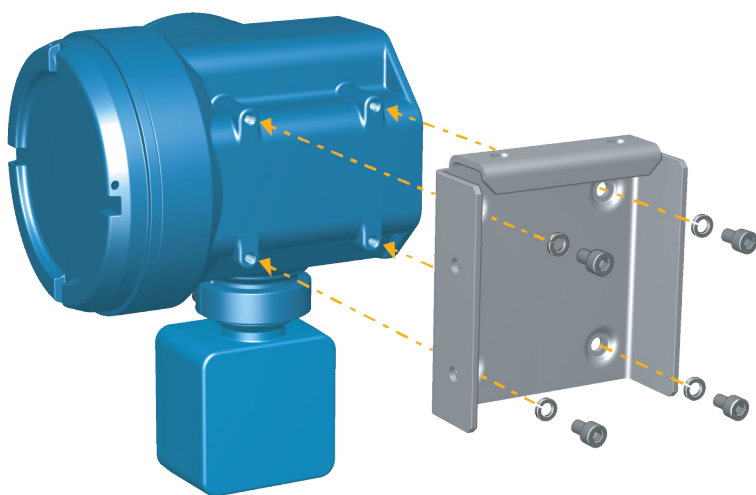

-
2. Using a wall-mount or pole-mount:
 - For wall-mount installations, secure the mounting bracket to the prepared surface.

Figure 2-2: Wall-mounting bracket dimensions

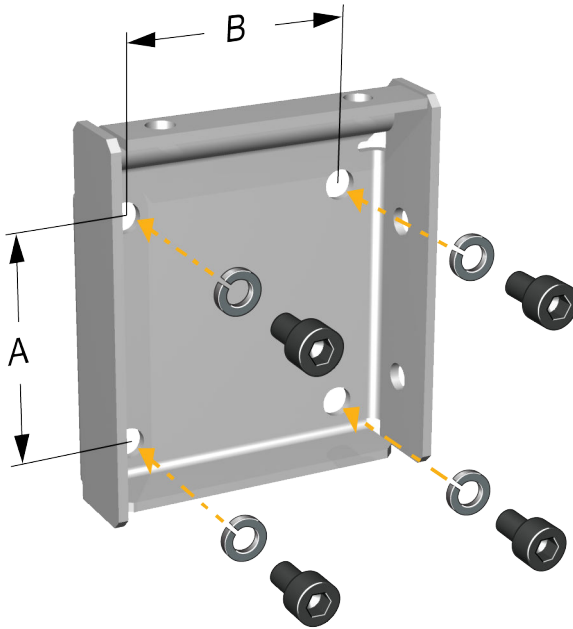

A. 2.8 in (71.4 mm)

B. 2.8 in (71.4 mm)

- For pole-mount installations, attach the U-bolt mounting piece to the instrument pole.

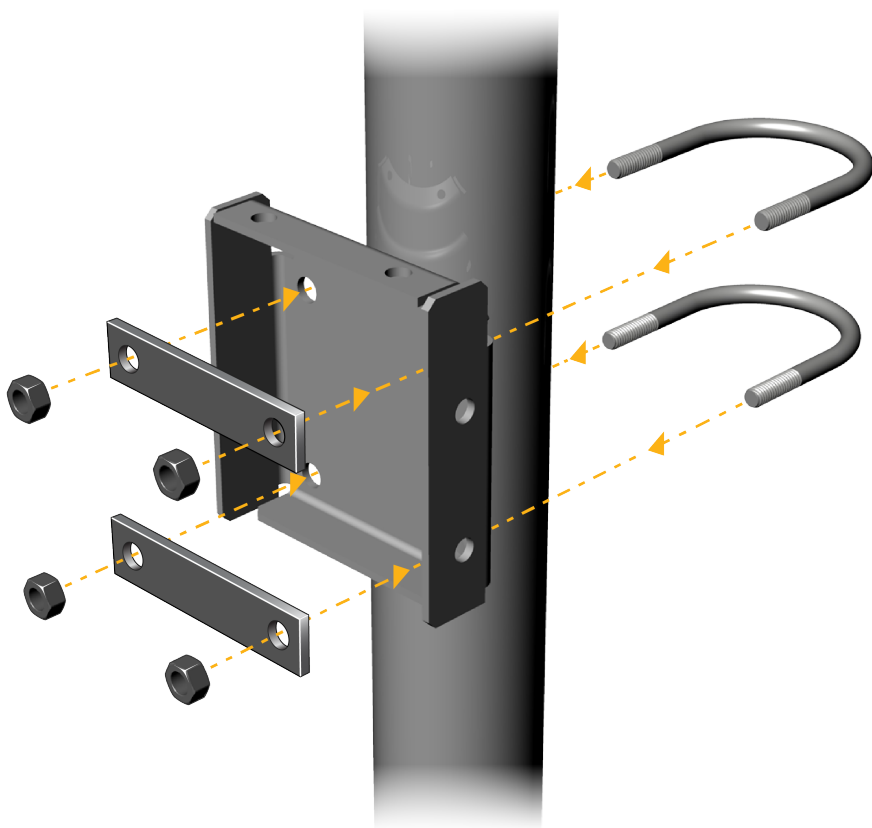
Figure 2-3: Pole-mounting bracket attachment

3. Place and attach the transmitter-mounting bracket to the mounting bracket secured to the wall or instrument pole.

Figure 2-4: Attaching and securing transmitter to mounting bracket

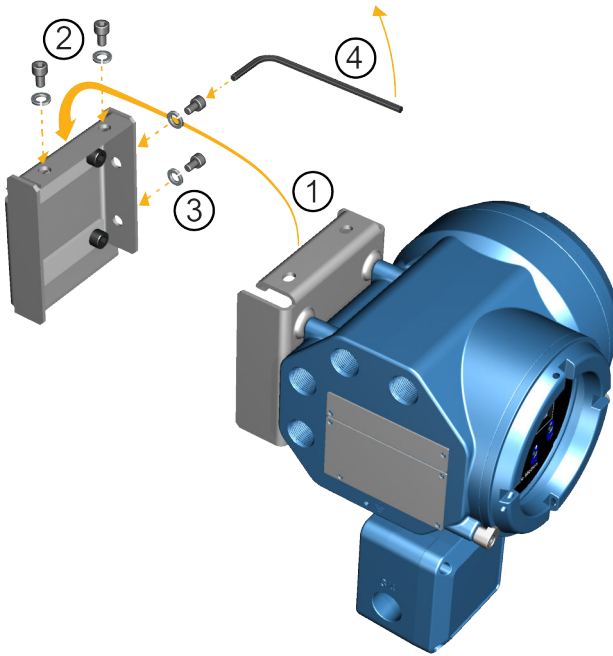

Tip

To ensure the mounting bracket holes are aligned, insert all attachment bolts into place before tightening.

2.3 Wire the 4-wire or 9-wire remote-mount transmitter to the sensor

Prerequisites

- Prepare 4-wire or 9-wire cable as described in the sensor documentation.
- Connect the cable to the sensor-mounted core processor or junction box as described in the sensor documentation. You can access all product documentation online via the Micro Motion product documentation DVD shipped with the product or at www.micromotion.com.

Procedure

1. Remove the transmitter-to-sensor wiring compartment cover to reveal the terminal connections.

Figure 2-5: Removal of the transmitter-to-sensor wiring compartment cover

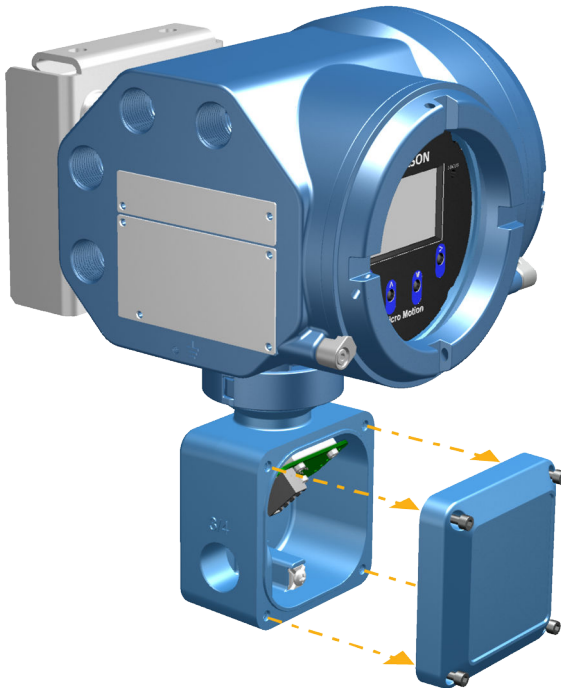

2. Feed the sensor wiring cable into the transmitter wiring compartment.

Figure 2-6: Sensor wiring feedthrough

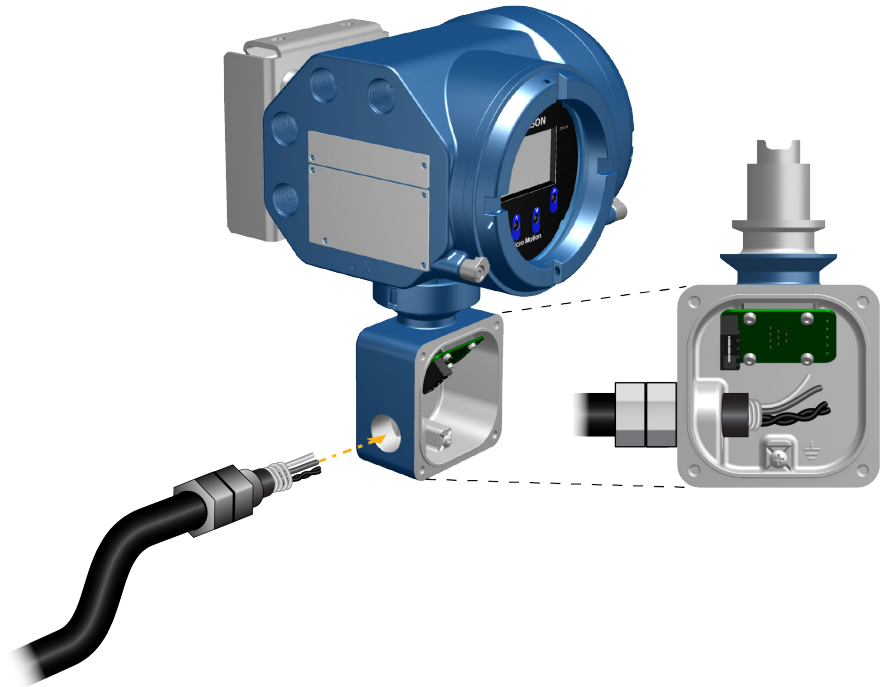

3. Connect the sensor wires to the appropriate terminals.

Note

Terminate the 4-wire cable drain wires only at the sensor/core processor end of the cable. See the sensor installation manual for more detail. Do not connect the 4-wire cable drain wires to the ground screw located inside the 5700 junction box.

- See [Figure 3](#) for 4-wire terminal connections.
- See [Figure 4](#) for 9-wire terminal connections.

Figure 2-7: 4-wire transmitter-to-sensor wiring connections

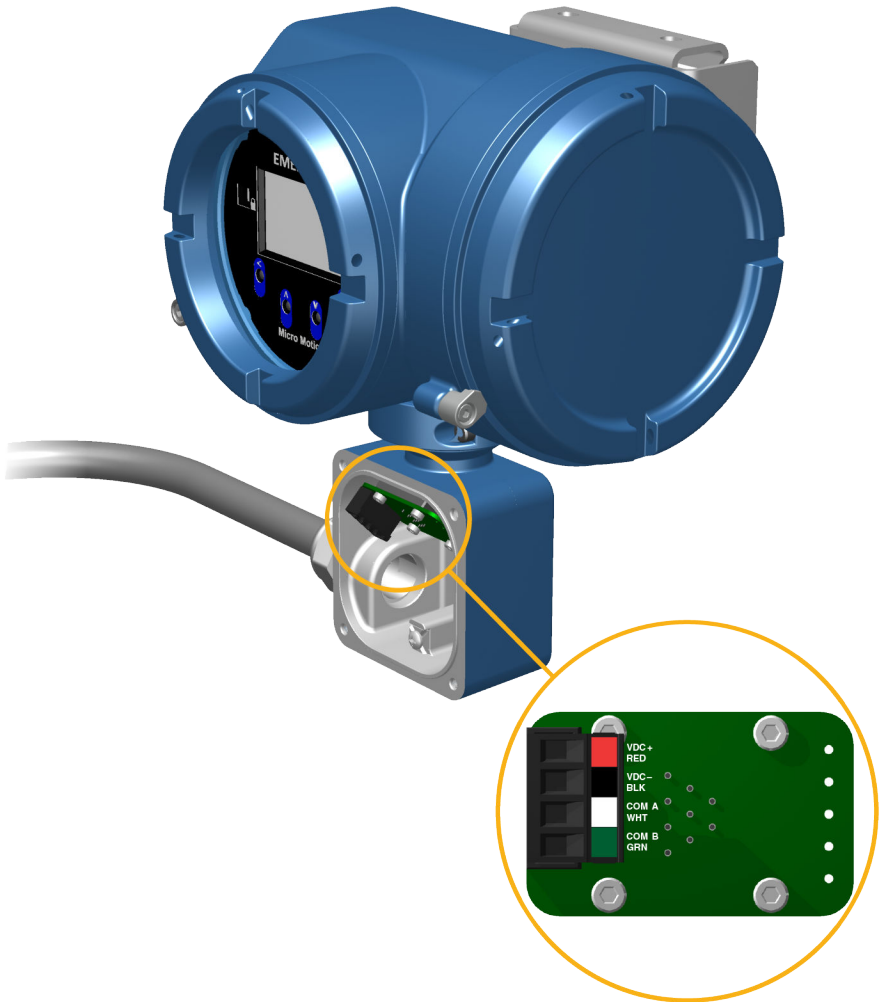
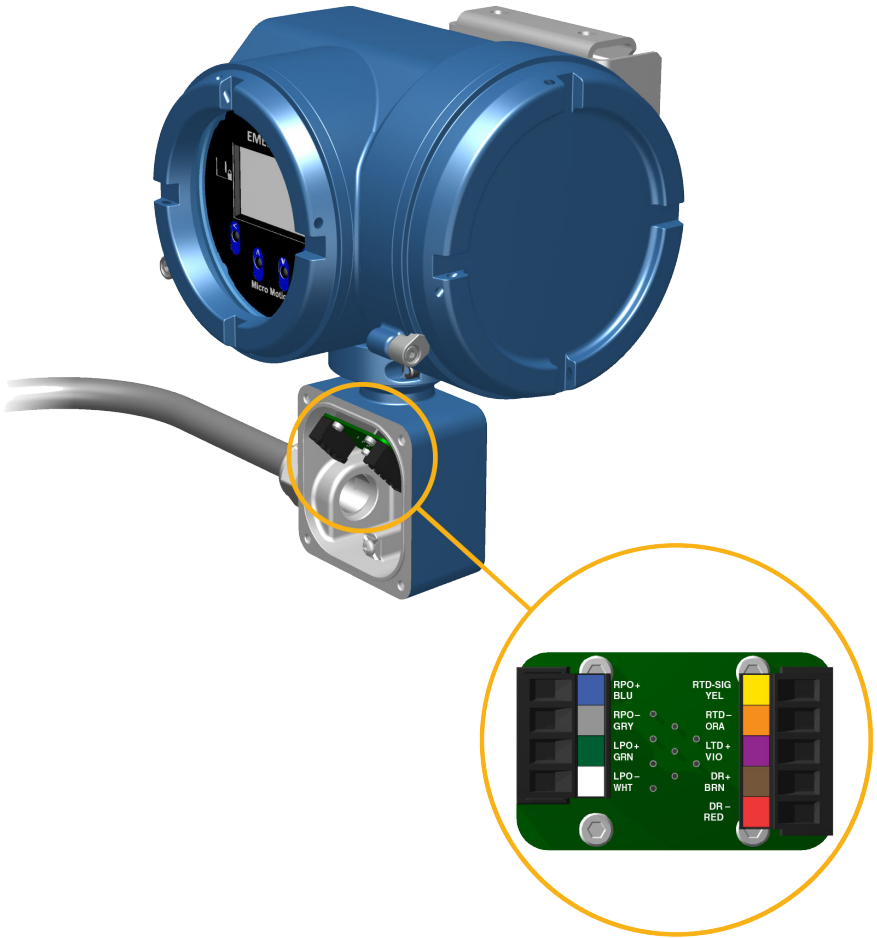

Figure 2-8: 9-wire transmitter-to-sensor wiring connections



Note

Connect the 4 drain wires in the 9-wire cable to the ground screw located inside the junction box.

4. Replace the transmitter-to-sensor wiring compartment cover and tighten the screws to 14-16 in-lbs.

2.4 Ground the meter components

In 4-wire or 9-wire remote installations, the transmitter and sensor are grounded separately.

Prerequisites

CAUTION!

Improper grounding could cause inaccurate measurements or meter failure.

WARNING!

Failure to comply with requirements for intrinsic safety in a hazardous area could result in an explosion.

Note

For hazardous area installations in Europe, refer to standard EN 60079-14 or national standards.

If national standards are not in effect, adhere to the following guidelines for grounding:

- Use copper wire, 14 AWG (2.5 mm²) or larger wire size.
- Keep all ground leads as short as possible, less than 1 Ω impedance.
- Connect ground leads directly to earth, or follow plant standards.

Procedure

1. Ground the sensor according to the instructions in the sensor documentation.
2. Ground the transmitter according to applicable local standards, using the transmitter's internal or external ground screw.
 - The internal ground screw is located inside the transmitter-to-sensor wiring compartment.
 - The external ground screw is located on the side of the transmitter located below the transmitter tag.

2.5 Rotate the transmitter on the sensor (optional)

In integral installations, you can rotate the transmitter on the sensor up to 360° in 45° increments.

1. Using a 4 mm hex key, loosen and remove the clamp securing the transmitter head in place.

Figure 2-9: Removal of the sensor clamp

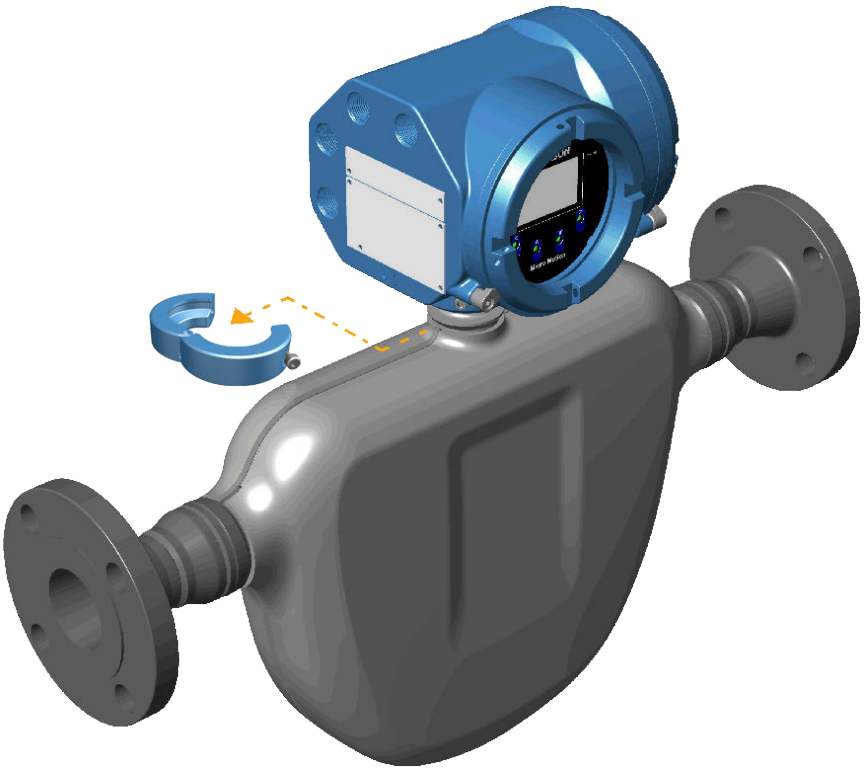

2. Gently lift the transmitter straight up, and rotate the transmitter to the desired position.

You can rotate the transmitter to any of the eight positions, but a stop exists that will not allow a full 360° rotation.

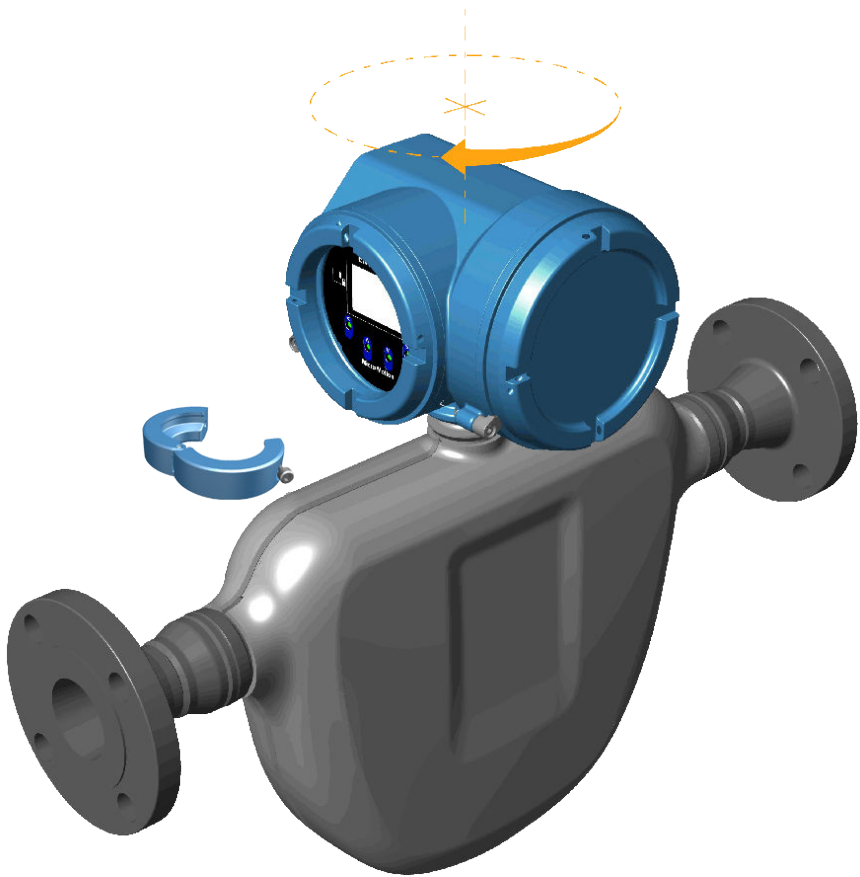
Figure 2-10: Rotation of the transmitter head

3. Gently lower the transmitter onto the base, confirming that the transmitter is in a locked position.
4. Replace the clamp in its original position and tighten the cap screw. Torque to 28 to 30 in-lbs (2.3 to 3.4 N-m).

Figure 2-11: Re-attachment of the sensor clamp

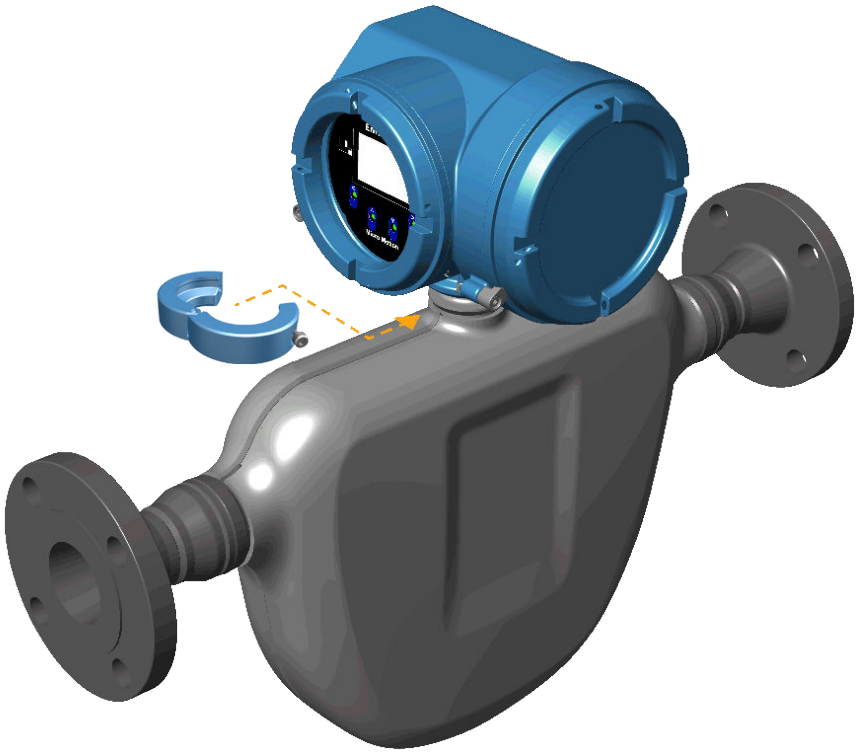

2.6 Rotate the user interface on the transmitter (optional)

The user interface on the transmitter electronics module can be rotated 90° or 180° from the original position.

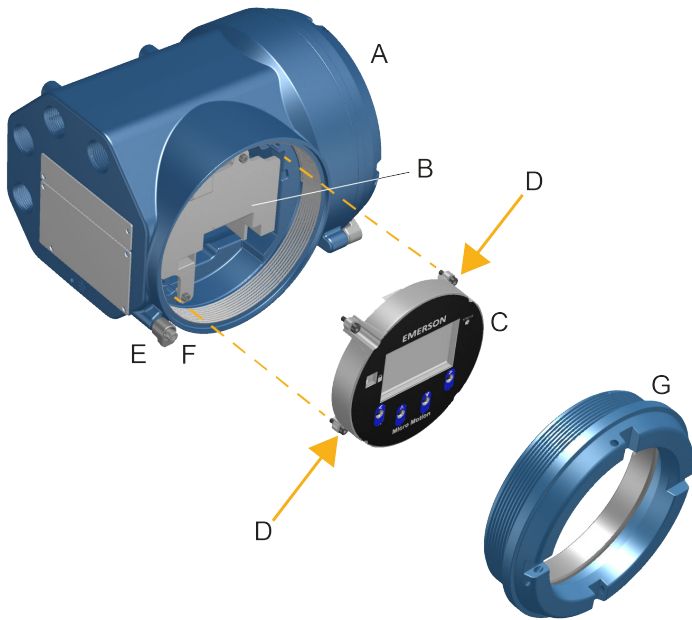
Figure 2-12: Display components

- A. Transmitter housing
- B. Sub-bezel
- C. Display module
- D. Display screws
- E. End-cap clamp
- F. Cap screw
- G. Display cover

Procedure

1. Shut off power to the unit.

⚠ WARNING!

If the transmitter is in a hazardous area, wait five minutes after disconnecting the power before opening the enclosure.

2. Loosen and rotate the end cap clamp so that it does not interfere with the cover.
3. Turn the display cover counterclockwise to remove it from the main enclosure.
4. Carefully loosen the semi-captive display screws while holding the display module in place.
5. Carefully pull the display module out of the main enclosure.
6. Rotate the display module to the desired position.
7. Gently press the display module back onto the connector.
8. Tighten display screws.
9. Place the display cover onto the main enclosure.
10. Turn the display cover clockwise until it is fully seated.
11. Replace the end-cap clamp by tightening the cap screw.
12. Restore power to the transmitter.

2.7 Rotate the sensor wiring junction box on a remote-mount transmitter (optional)

In remote-mount installations, you can rotate the sensor wiring junction box on the transmitter plus or minus 180°.

1. Using a 4 mm hex key, loosen and remove the clamp securing the sensor wiring junction box in place.

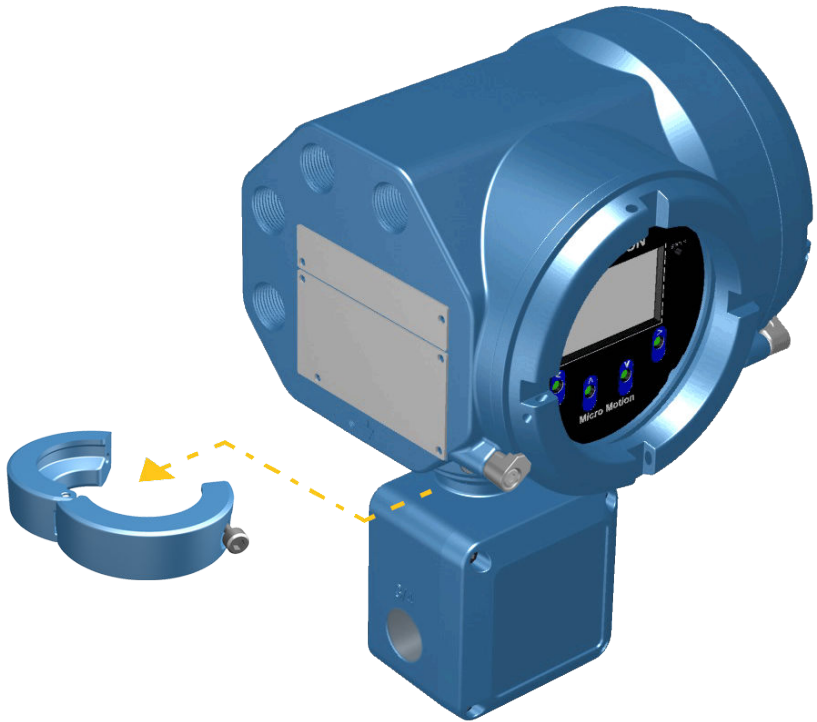
Figure 2-13: Removal of the clamp

2. Gently rotate the junction box to the desired position.

You can rotate the junction box plus or minus 180° to any position.

Figure 2-14: Rotation of the sensor wiring junction box

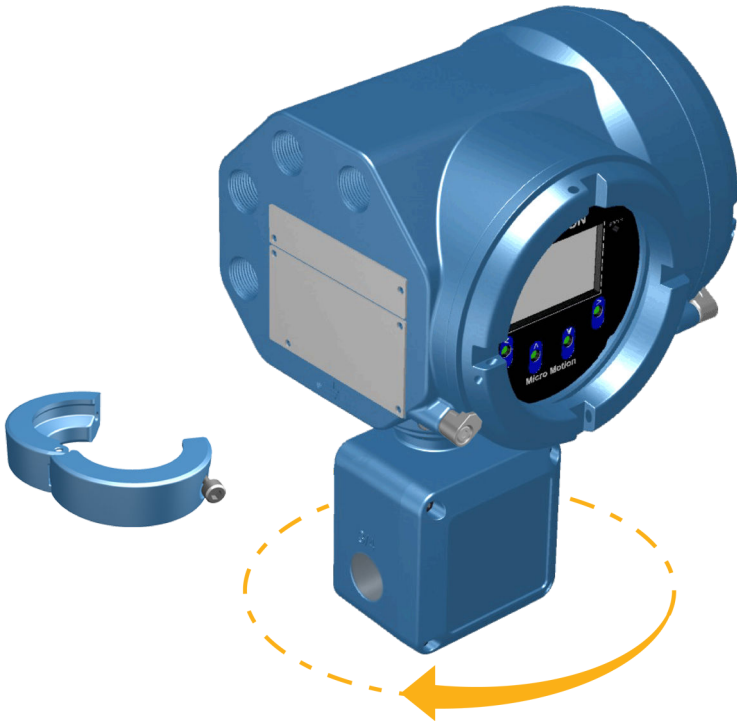

3. Gently set the junction box into its new position, confirming that the position is locked.
4. Replace the clamp in its original position and tighten the cap screw. Torque to 28 to 30 in-lbs (2.3 to 3.4 N-m).

Figure 2-15: Re-attachment of the clamp

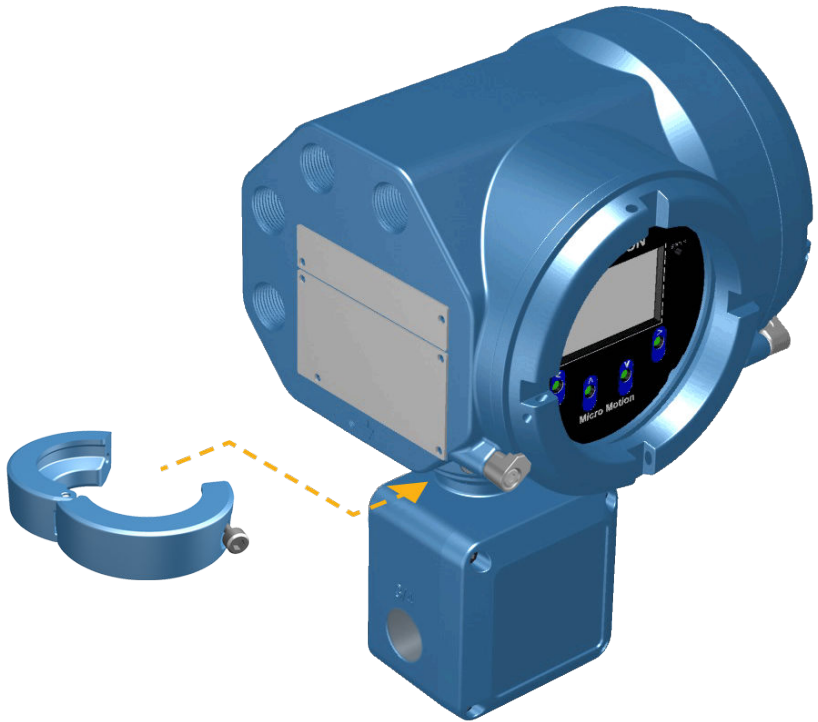

3 Wiring the channels

Topics covered in this chapter:

- *Access the wiring channels*
- *Wire the mA output in an explosion-proof/flameproof or non-hazardous area*
- *Wire the mA/HART output in an explosion-proof/flameproof or non-hazardous area*
- *Wire the Frequency output in an explosion-proof/flameproof or non-hazardous area*
- *Wire the Discrete output in an explosion-proof/flameproof or non-hazardous area*
- *Wire the RS-485 output in an explosion-proof/flameproof or non-hazardous area*
- *Wire the mA input in an explosion-proof/flameproof or non-hazardous area*
- *Wire the Discrete input in an explosion-proof/flameproof or non-hazardous area*
- *Wire the Frequency input in an explosion-proof/flameproof or non-hazardous area*

3.1 Access the wiring channels

1. Remove the wiring access cover to reveal the I/O wiring terminal block connectors.

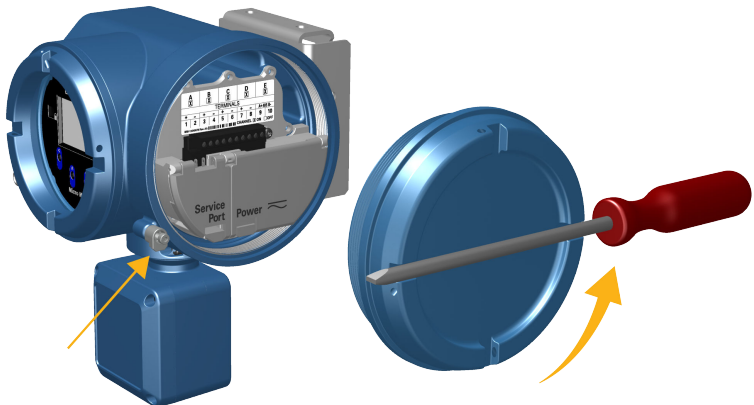

2. Confirm which transmitter channels are activated, or ON, and identify the type of configuration you will be wiring to based on the options available (see [Figure 1](#) and [Table 1](#)).

Figure 3-1: Activated channel identification

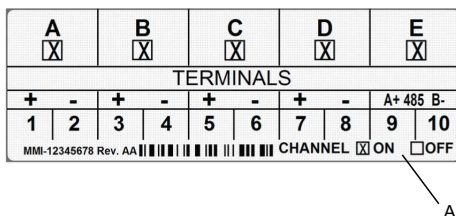

A. Key to identify the activated input/outputs

Table 3-1: Available channel configurations

Output Channel	A		B		C		D		E	
	1	2	3	4	5	6	7	8	9	10
Wiring terminals	1	2	3	4	5	6	7	8	9	10
Outputs options	mA output (1) (HART)		mA Output (2)		mA Output (3)		mA Input		RS-485	
			Frequency (2)		Frequency (1)		Frequency (2)			
			Discrete Output (1)		Discrete Output (2)		Discrete Output (3)			
					Discrete Input (1)		Discrete Input (2)			
							Frequency Input			

3. (Recommended) Record the channel and wiring configuration on the label provided inside the transmitter housing cover.

Figure 3-2: Channel and wiring configurations label

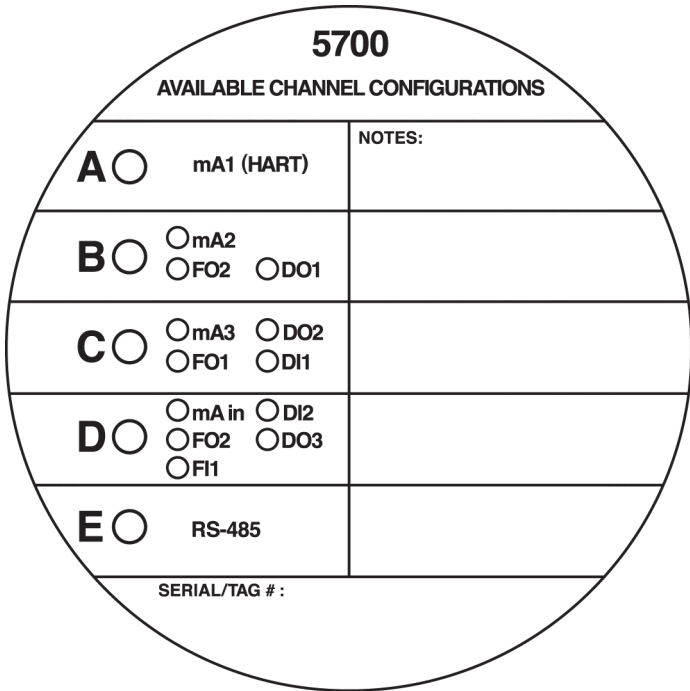

3.2 Wire the mA output in an explosion-proof/flameproof or non-hazardous area

- *Wire the mA output (internally powered)* (Section 3.2.1)
- *Wire the mA output (externally powered)* (Section 3.2.2)

3.2.1 Wire the mA output (internally powered)

Important

Meter installation and wiring should be performed by suitably trained personnel only in accordance with the applicable code of practice.

Procedure

Wire to the appropriate output terminal and pins.

Figure 3-3: mA output wiring (internally powered)

- A. mA output
- B. Channel A, B, or C
- C. 820 Ω maximum loop resistance
- D. Signal device

3.2.2 Wire the mA output (externally powered)

Important

Meter installation and wiring should be performed by suitably trained personnel only in accordance with the applicable code of practice.

Procedure

Wire to the appropriate output terminal and pins.

Figure 3-4: mA output wiring (externally powered)

- A. mA output
- B. Channel A, B, or C
- C. 5–30 VDC (maximum)
- D. See [Figure 3-5](#) for maximum loop resistance
- E. Signal device

Figure 3-5: Externally powered mA output: maximum loop resistance

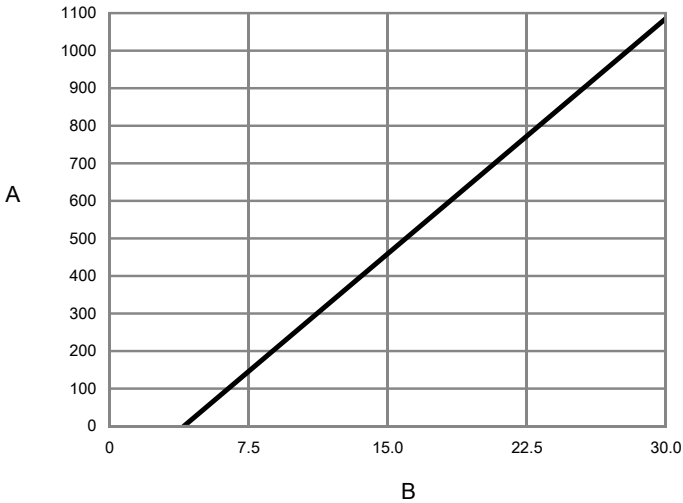

- A. Maximum resistance (Ω)
- B. External supply voltage (V)

3.3 Wire the mA/HART output in an explosion-proof/ flameproof or non-hazardous area

- [Wire the mA/HART output \(internally powered\)](#) (Section 3.3.1)
- [Wire the mA/HART output \(externally powered\)](#) (Section 3.3.2)
- [Wire the mA/HART multidrop installation \(internally or externally powered\)](#) (Section 3.3.3)

3.3.1 Wire the mA/HART output (internally powered)

Important

Meter installation and wiring should be performed by suitably trained personnel only in accordance with the applicable code of practice.

Procedure

Wire to the appropriate output terminal and pins.

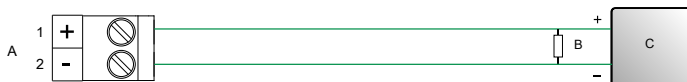
Figure 3-6: mA/HART output wiring (internally powered)

- A. mA/HART output
 B. 250–600 Ω resistance
 C. HART device

3.3.2 Wire the mA/HART output (externally powered)

Important

Meter installation and wiring should be performed by suitably trained personnel only in accordance with the applicable code of practice.

Procedure

Wire to the appropriate output terminal and pins.

Figure 3-7: mA/HART output wiring (externally powered)

- A. mA/HART output
 B. 5–30 VDC (maximum)
 C. 250–600 Ω resistance (see [Figure 3-8](#) for maximum loop resistance)
 D. HART device

Figure 3-8: Externally powered mA/HART output: maximum loop resistance

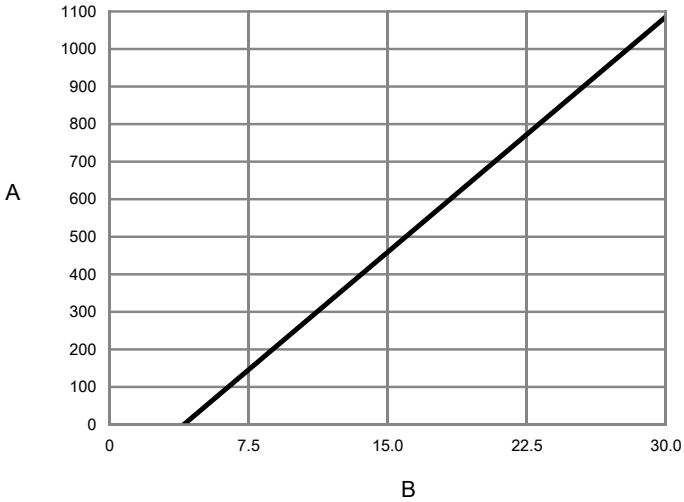

- A. Maximum resistance (Ω)
- B. External supply voltage (V)

3.3.3 Wire the mA/HART multidrop installation (internally or externally powered)

Important

Meter installation and wiring should be performed by suitably trained personnel only in accordance with the applicable code of practice.

Procedure

See the following figure for information on wiring a mA/HART multidrop installation.

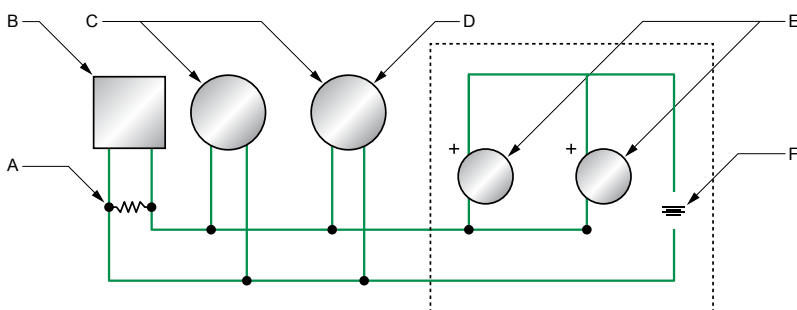
Figure 3-9: mA/HART multidrop wiring

- A. 250–600 Ω resistance
 B. HART-compatible host or controller
 C. HART-compatible transmitter (internally powered)
 D. Model 5700 transmitter (internally powered) mA/HART connections
 E. SMART FAMILY™ transmitters
 F. 24 VDC loop power supply required for external transmitter

3.4 Wire the Frequency output in an explosion-proof/flameproof or non-hazardous area

- *Wire the Frequency output (internally powered) (Channels B/C)* (Section 3.4.1)
- *Wire the Frequency output (externally powered) (Channels B/C)* (Section 3.4.2)
- *Wire the Frequency output (internally powered) (Channel D)* (Section 3.4.3)
- *Wire the Frequency output (externally powered) (Channel D)* (Section 3.4.4)

3.4.1 Wire the Frequency output (internally powered) (Channels B/C)

Important

Meter installation and wiring should be performed by suitably trained personnel only in accordance with the applicable code of practice.

Procedure

Wire to the appropriate output terminal and pins.

Figure 3-10: Frequency output wiring (internally powered)



- A. Frequency output
- B. Channel B or C
- C. See [Figure 3-11](#) for output amplitude versus load resistance
- D. Counter

Figure 3-11: Internally powered Frequency output: output amplitude versus load resistance [24 VDC (Nom) open circuit]

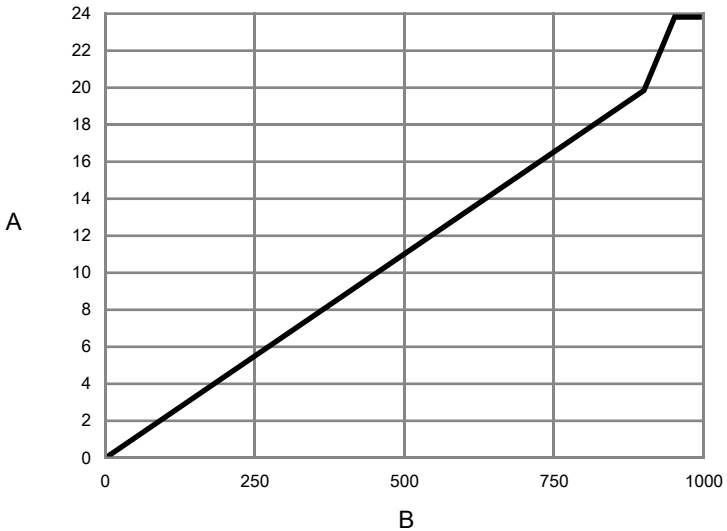

- A. Output amplitude (V)
- B. Load resistor (Ω)

3.4.2 Wire the Frequency output (externally powered) (Channels B/C)

Important

Meter installation and wiring should be performed by suitably trained personnel only in accordance with the applicable code of practice.

Procedure

Wire to the appropriate output terminal and pins.

Figure 3-12: Frequency output wiring (externally powered)



- A. Frequency output
- B. Channel B or C
- C. 5–30 VDC (maximum)
- D. 500 mA current (maximum)
- E. Counter

3.4.3 Wire the Frequency output (internally powered) (Channel D)

Important

Meter installation and wiring should be performed by suitably trained personnel only in accordance with the applicable code of practice.

Procedure

Wire to the appropriate output terminal and pins.

Figure 3-13: Frequency output wiring (internally powered)



- A. Frequency output
- B. See [Figure 3-14](#) for output amplitude versus load resistance
- C. Counter

Figure 3-14: Internally powered Frequency output: output amplitude versus load resistance [24 VDC (Nom) open circuit]

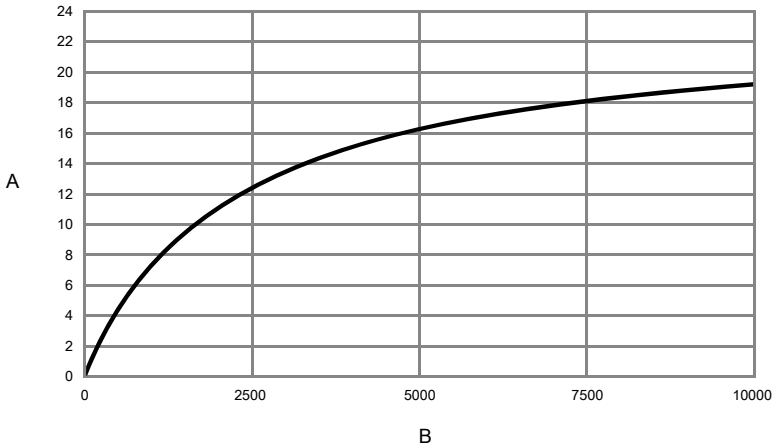

- A. Output amplitude (V)
- B. Load resistor (Ω)

3.4.4 Wire the Frequency output (externally powered) (Channel D)

Important

Meter installation and wiring should be performed by suitably trained personnel only in accordance with the applicable code of practice.

Procedure

Wire to the appropriate output terminal and pins.

Figure 3-15: Frequency output wiring (externally powered)

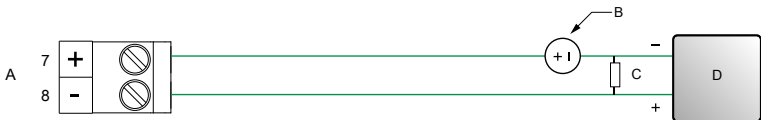

- A. Frequency output
- B. 3–30 VDC (maximum)
- C. 500 mA current (maximum)
- D. Signal device

3.5 Wire the Discrete output in an explosion-proof/ flameproof or non-hazardous area

- *Wire the Discrete output (internally powered) (Channels B/C)* (Section 3.5.1)
- *Wire the Discrete output (externally powered) (Channels B/C)* (Section 3.5.2)
- *Wire the Discrete output (internally powered) (Channel D)* (Section 3.5.3)
- *Wire the Discrete output (externally powered) (Channel D)* (Section 3.5.4)

3.5.1 Wire the Discrete output (internally powered) (Channels B/C)

Important

Meter installation and wiring should be performed by suitably trained personnel only in accordance with the applicable code of practice.

Procedure

Wire to the appropriate output terminal and pins.

Figure 3-16: Discrete output wiring (internally powered)



A. Discrete output

B. Channel B or C

C. See [Figure 3-17](#) for output amplitude versus load resistance

D. Counter

Figure 3-17: Internally powered Discrete output: output amplitude versus load resistance [24 VDC (Nom) open circuit]

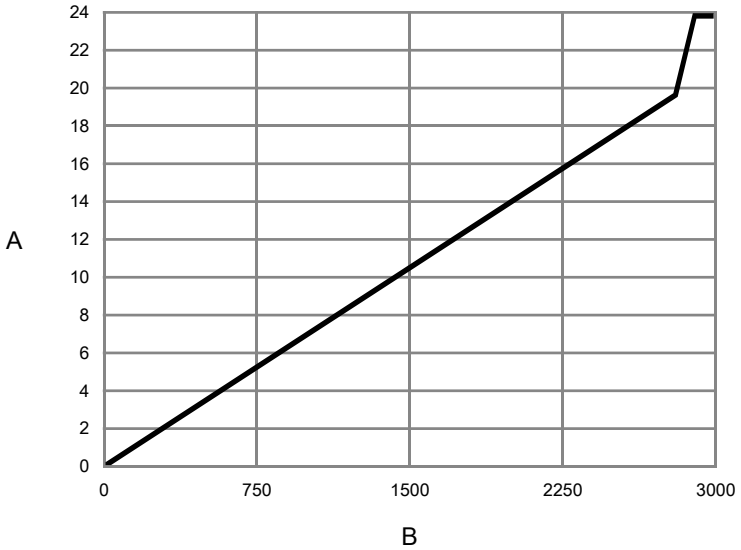

A. Output amplitude (V)

B. Load resistor (Ω)

3.5.2 Wire the Discrete output (externally powered) (Channels B/C)

Important

Meter installation and wiring should be performed by suitably trained personnel only in accordance with the applicable code of practice.

Procedure

Wire to the appropriate output terminal and pins.

Figure 3-18: Discrete output wiring (externally powered)

- A. Discrete output
- B. Channel B or C
- C. 3–30 VDC (maximum)
- D. 500 mA current (maximum)
- E. Counter

3.5.3 Wire the Discrete output (internally powered) (Channel D)

Important

Meter installation and wiring should be performed by suitably trained personnel only in accordance with the applicable code of practice.

Procedure

Wire to the appropriate output terminal and pins.

Figure 3-19: Discrete output wiring (internally powered)

- A. Discrete output
- B. See [Figure 3-20](#) for output amplitude versus load resistance
- C. Counter

Figure 3-20: Internally powered Discrete output: output amplitude versus load resistance [24 VDC (Nom) Open Circuit]

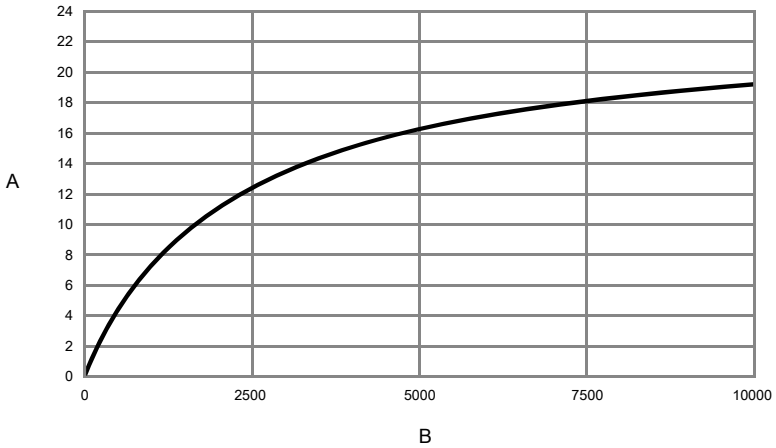

- A. Output amplitude (V)
- B. Load resistor (Ω)

3.5.4 Wire the Discrete output (externally powered) (Channel D)

Important

Meter installation and wiring should be performed by suitably trained personnel only in accordance with the applicable code of practice.

Procedure

Wire to the appropriate output terminal and pins.

Figure 3-21: Discrete output wiring (externally powered)

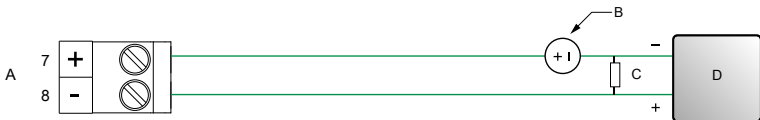

- A. Discrete output
- B. 3–30 VDC (maximum)
- C. 500 mA current (maximum)
- D. Signal device

3.6 Wire the RS-485 output in an explosion-proof/flameproof or non-hazardous area

Important

Meter installation and wiring should be performed by suitably trained personnel only in accordance with the applicable code of practice.

Procedure

Wire to the appropriate output terminal and pins.

Figure 3-22: RS-485 output wiring



- A. RS-485 output
- B. RS-485/A
- C. RS-485/B

Note

The transmitter does not provide any RS-485 termination resistance.

3.7 Wire the mA input in an explosion-proof/flameproof or non-hazardous area

- [Wire the mA input \(internally powered\)](#) (Section 3.7.1)
- [Wire the mA input \(externally powered\)](#) (Section 3.7.2)

3.7.1 Wire the mA input (internally powered)

Important

Meter installation and wiring should be performed by suitably trained personnel only in accordance with the applicable code of practice.

Procedure

Wire to the appropriate input terminal and pins.

Figure 3-23: mA input wiring (internally powered)

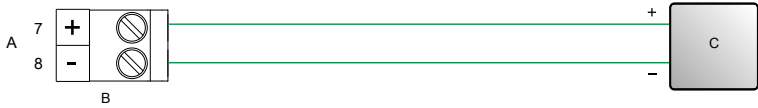

- A. mA input
- B. 100 Ω input resistance at Channel D
- C. 4–20 mA input device

3.7.2 Wire the mA input (externally powered)

Important

Meter installation and wiring should be performed by suitably trained personnel only in accordance with the applicable code of practice.

Procedure

Wire to the appropriate input terminal and pins.

Figure 3-24: mA input wiring (externally powered)



- A. mA input
- B. 100 Ω input resistance at Channel D
- C. 4–20 mA input device
- D. 30 VDC (maximum)

3.8 Wire the Discrete input in an explosion-proof/flameproof or non-hazardous area

- [Wire the Discrete input \(internally powered\)](#) (Section 3.8.1)
- [Wire the Discrete input \(externally powered\)](#) (Section 3.8.2)

3.8.1 Wire the Discrete input (internally powered)

Important

Meter installation and wiring should be performed by suitably trained personnel only in accordance with the applicable code of practice.

Procedure

Wire to the appropriate input terminal and pins.

Figure 3-25: Discrete input wiring (internally powered)

- A. Discrete input
- B. Channel C or D
- C. Switch

3.8.2 Wire the Discrete input (externally powered)**Important**

Meter installation and wiring should be performed by suitably trained personnel only in accordance with the applicable code of practice.

Procedure

Wire to the appropriate input terminal and pins.

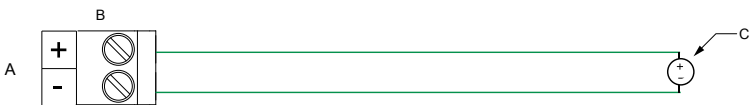
Figure 3-26: Discrete input wiring (externally powered)

- A. Discrete input
- B. Channel C or D
- C. 30 VDC (maximum)

Note

- Maximum positive threshold is 3 VDC.
- Minimum negative threshold is 0.6 VDC.

3.9 Wire the Frequency input in an explosion-proof/ flameproof or non-hazardous area

- *Wire the Frequency input (internally powered)* (Section 3.9.1)
- *Wire the Frequency input (externally powered)* (Section 3.9.2)

3.9.1 Wire the Frequency input (internally powered)

Important

Meter installation and wiring should be performed by suitably trained personnel only in accordance with the applicable code of practice.

Procedure

Wire to the appropriate input terminal and pins.

Figure 3-27: Frequency input wiring (internally powered)



- A. Frequency input
 - B. Frequency input device
 - C. (Optional) 1–10 K Ω resistor/open collector
 - D. (Optional) 3–30 VDC
-

3.9.2 Wire the Frequency input (externally powered)

Important

Meter installation and wiring should be performed by suitably trained personnel only in accordance with the applicable code of practice.

Procedure

Wire to the appropriate input terminal and pins.

Figure 3-28: Frequency input wiring (externally powered)

- A. Frequency input
- B. Frequency input device
- C. 1–10 K Ω resistance
- D. 3–30 VDC

4 Wiring the power supply

A user supplied switch may be installed in the power supply line.

Important

For compliance with the Low Voltage Directive 2014/35/EU (European installations), a switch in close proximity to the transmitter is required.

Procedure

1. Remove the wiring access cover.
 2. Open the Power warning flap to locate the power terminals.
-

Figure 4-1: Location of power supply wiring terminals and equipment ground

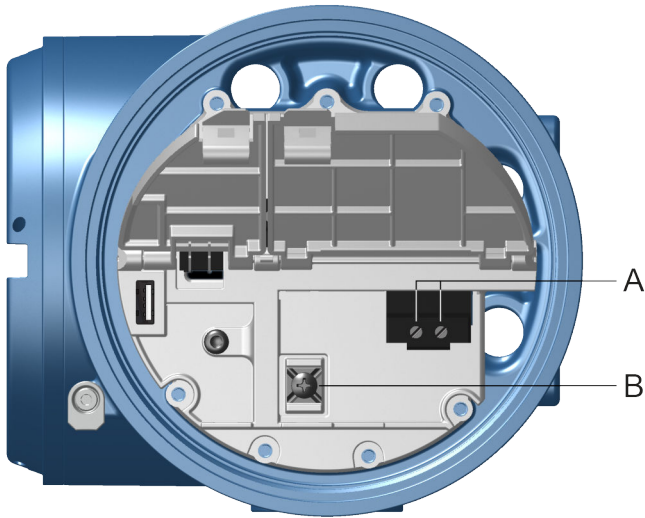

- A. Power supply wiring terminals (+ and -)
 - B. Equipment ground
-

3. Connect the power supply wires:
 - For DC power: connect to terminals + and -.
 - For AC power: connect to terminals L/L1 (line) and N/L2 (neutral).
4. Tighten the 2 screws holding the power connector in place.

5. Ground the power supply using the equipment ground, also under the Power warning flap.

5 Power up the transmitter

The transmitter must be powered up for all configuration and commissioning tasks, or for process measurement.

1. Follow appropriate procedures to ensure that a new device on the network does not interfere with existing measurement and control loops.
2. Ensure that all transmitter and sensor covers and seals are closed.

WARNING!

To prevent ignition of flammable or combustible atmospheres, ensure that all covers and seals are tightly closed. For hazardous area installations, applying power while housing covers are removed or loose can cause an explosion.

3. Turn on the electrical power at the power supply.

The transmitter will automatically perform diagnostic routines. During this period, the Transmitter Initializing alert is active. The diagnostic routines should complete in approximately 30 seconds.

Postrequisites

Although the sensor is ready to receive process fluid shortly after power-up, the electronics can take up to 10 minutes to reach thermal equilibrium. Therefore, if this is the initial startup, or if power has been off long enough to allow components to reach ambient temperature, allow the electronics to warm up for approximately 10 minutes before relying on process measurements. During this warm-up period, you may observe minor measurement instability or inaccuracy.

6 Configuring the transmitter with Guided Setup

At initial startup of the transmitter, the guided configuration screen appears on the transmitter display. This tool guides you through basic configuration of the transmitter. The guided setup allows you to upload configuration files, set the transmitter display options, configure channels, and review sensor calibration data.

To access the guided setup screen from the display main menu, go to: Startup Tasks > Guided Setup.

7 Using the Display controls

The transmitter display interface includes a display (LCD panel) and four optical switches – left, up, down, and right arrow keys – used to access the display menus and navigate the display screens.

1. To activate an optical switch, block the light by holding your thumb or finger in front of the opening (see [Figure 7-1](#)).

You can activate the optical switch through the lens. Do not remove the transmitter housing cover.

Important

The transmitter only detects one switch selection at a time. Be sure to place your thumb or finger directly over a single optical switch, and ensure no other switches are being obstructed.

Figure 7-1: Proper finger positioning for activating an optical switch

2. Use the arrow indicators on the display screen to identify which optical switch to use to navigate the screen (see [Figure 7-2](#) and [Figure 7-3](#)).

Important

When using the arrow keys, you must first activate the optical switch then release the same switch by removing your finger from the glass to move up, down, right, left or to make a selection. To enable auto-scroll when navigating up or down, activate the appropriate switch and continue to hold for one second. Release the switch when the desired selection is highlighted.

Figure 7-2: Example 1: Active arrow indicators on the transmitter display



Figure 7-3: Example 2: Active arrow indicators on the transmitter display



8 Available Service Port connection

⚠ WARNING!

If the transmitter is in a hazardous area, do not remove the housing cover while power is being supplied to the unit. Removing the housing cover while power is supplied to the unit could cause an explosion. To access the service port in a hazardous environment, be sure to remove power from the transmitter and wait 5 minutes before removing the housing cover.

You can interface with the transmitter through the service port connection, located under the Service Port warning flap at the wiring access points. To interface with the service port, you can use commonly available USB hardware, such as a USB drive or USB cable. Use the service port connection to download or upload data from/to the transmitter.

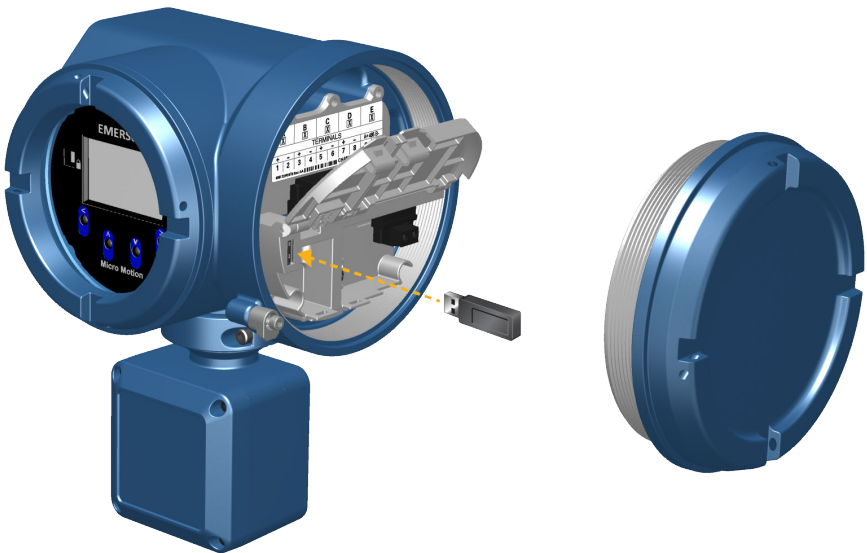



Installation Manual
Part Number: MMI-20027478, rev. AC
December 2014

Micro Motion Inc. USA

Worldwide Headquarters
7070 Winchester Circle
Boulder, Colorado 80301
T +1 303-527-5200
T +1 800-522-6277
F +1 303-530-8459
www.micromotion.com

Micro Motion Europe

Emerson Process Management
Neonstraat 1
6718 WX Ede
The Netherlands
T +31 (0) 318 495 555
F +31 (0) 318 495 556
www.micromotion.nl

Micro Motion Asia

Emerson Process Management
1 Pandan Crescent
Singapore 128461
Republic of Singapore
T +65 6777-8211
F +65 6770-8003

Micro Motion United Kingdom

Emerson Process Management Limited
Horsfield Way
Bredbury Industrial Estate
Stockport SK6 2SU U.K.
T +44 0870 240 1978
F +44 0800 966 181

Micro Motion Japan

Emerson Process Management
1-2-5, Higashi Shinagawa
Shinagawa-ku
Tokyo 140-0002 Japan
T +81 3 5769-6803
F +81 3 5769-6844

©2014 Micro Motion, Inc. All rights reserved.

The Emerson logo is a trademark and service mark of Emerson Electric Co. Micro Motion, ELITE, ProLink, MVD and MVD Direct Connect marks are marks of one of the Emerson Process Management family of companies. All other marks are property of their respective owners.

