

8201 Remote Terminal Unit

8201 — 16 Channel Digital I/O Expansion Module

RTU Firmware Version : RTU3_38

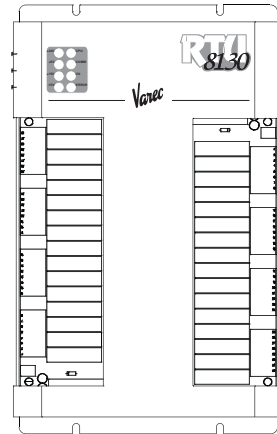

Copyright

All rights reserved. Printed in the United States of America.

Except as permitted under the United States Copyright Act of 1976, no part of this publication may be reproduced, stored in a retrieval system or transmitted in any form or by any means – electronic, mechanical, photocopying, recording, or otherwise – without the prior written permission of the Publisher:

Varec, Inc.
5834 Peachtree Corners East
Norcross (Atlanta), Georgia 30092
Phone: (770) 447-9202
Fax: (770) 662-8939

Trademarks Acknowledged

Varec, Inc. recognizes all other trademarks. Trademarks of other products mentioned in this manual are held by the companies producing them.

Microsoft® is a registered trademark of Microsoft Corporation.

Acrobat® is a registered trademark of Adobe Systems Incorporated.

MODBUS® is a registered trademark of Modicon, Inc.

TIWAY® is a registered trademark of Texas Instruments Corporation

HART® interface is a registered trademark of HART Communications Foundation

Delrin is a registered trademark of E. I. du Pont de Nemours Co. (Inc.), Wilmington, DL

Dow Corning RTV 737 is a registered trademark of Dow Corning Inc., Midland MI

Loctite is a registered trademark of Loctite Corp., Newington, CT

Teflon is a registered trademark of E. I. du Pont de Nemours Co. (Inc.), Wilmington, DL

Viton is a registered trademark of E. I. Du Pont de Nemours Co. (Inc.), Wilmington, DL

FuelsManager® is a registered trademark of Varec, Inc. Copyright 2004

8130 RTU8130® is a registered trademark of Varec, Inc. Copyright 2003

TankGate™ is a trademark of Varec, Inc. 2003

TankView® is a registered trademark of Varec, Inc. Copyright 2003

Varec® is a registered trademark of Varec, Inc. Copyright 2003

All other product and service names mentioned are the trademarks of their respective companies.

Disclaimer of Warranties

The contract between the Seller and the Buyer states the entire obligation of the Seller. The contents of this instruction manual shall not become part of or modify any prior or existing agreement, commitment, or relationship between the Seller and Buyer. There are no express or

implied warranties set out in this instruction manual. The only warranties that apply are those in the existing contract between the Seller and Buyer.

The 8201 RTU has not been tested by Varec under all possible operational conditions, and Varec may not have all the data relative to your application. The information in this instruction manual is not all inclusive and does not and cannot take into account all unique situations. Consequently, the user should review this product literature in view of his or her application. If you have any further questions, please contact Varec for assistance.

Limitations of Seller's Liability

In the event that a court holds that this instruction manual created some new warranties, Seller's liability shall be limited to repair or replacement under the standard warranty clause. In no case shall the Seller's liability exceed that stated as Limitations of Remedy in the contract between the Seller and Buyer.

Use of parts that are not manufactured or supplied by Varec voids any warranty and relieves Varec of any obligation to service the product under warranty. Varec recommends the use of only Varec manufactured or supplied parts to maintain or service the 8201 RTU.

Terms of Use

The information provided in this document is provided "as is" without warranty of any kind. Varec, Inc. disclaim all warranties, either express or implied, including the warranties of merchantability and fitness for a particular purpose. In no event shall Varec, Inc. or its suppliers be liable for any damages whatsoever including direct, indirect, incidental, consequential, loss of business profits or special damages, even if Varec, Inc. or its suppliers have been advised of the possibility of such damages.

This manual is solely intended to describe product installation and functions and should not be used for any other purpose. It is subject to change without prior notice. This manual was prepared with the highest degree of care. However, should you find any errors or have any questions, contact one of our service offices or your local sales agent.

Safety Precaution Definitions

Caution! Damage to equipment may result if this precaution is disregarded.

Warning! Direct injury to personnel or damage to equipment which can cause injury to personnel may result if this precaution is not followed.

Safety Precautions

Read this manual carefully and make sure you understand its contents before using this product. Follow all instructions and safety guidelines presented in this manual when using this product. If the user does not follow these instructions properly, Varec cannot guarantee the safety of the system.

Note Comply with all applicable regulations, codes, and standards. For safety precautions, the user should refer to the appropriate industry or military standards.

Caution! Electrical Hazard! Read and understand static and lightning electrical protection and grounding described in API 2003. Make certain that the installation, operation, and maintenance conforms with the practice set forth therein.

Warning! Striking the product with a metal object could cause a spark to occur. When removing or replacing the product in flammable or hazardous liquid storage areas, take necessary measures to protect it from impact.

Warning! Sparks or static charge could cause fire or explosion! Mechanical connections, worker activity and worker clothing may accumulate electrostatic charges. Care should be used in flammable environments to avoid the hazard.

Contents

1	Overview	1
	Features	1
	General	1
	Applications	1
	Specifications	1
	Memory	1
	DC Power Requirements	2
	AC Power Requirements	2
	Host/Slave Communications	2
	Physical	2
	Environmental	2
	Digital Inputs	2
	Digital Outputs	2
	Analog Inputs	3
	Analog Outputs	3
	Intelligent Communications Interfaces	3
	Gas Tube Protection	4
	Field Maintenance	4
	I/O Expansion Modules	4
2	Hardware and Software	7
	Hardware Description	7
	Hardware Block Diagram	8
	Software Description	8
	Software Features	9
	Real-Time / Multitasking Executive	9
	Real-Time Clock	9
	Automatic Fault Recovery	9
	Firmware	10
	Communications	10
	Protocols	10
	I/O Scanning Task	11
	Point Executive	11
	Database Manager	11
	System Tasks	12
3	Installation	13
	General Safety Guidelines	13
	Installation Safety Guidelines	13
	Installation	14

	Mounting the 8130 RTU	15
	Mounting the Enclosure	16
	Wiring Up Power	16
	Grounding	16
	Installing Communications	17
	Establishing Host Communications	18
	Configuring I/O Expansion Modules	18
	Recommended Maintenance Procedure	18
4	Configuration	21
	Motherboard Description	21
	Power Supply	23
	MOVs and Gas Tubes	25
	Switches and Indicators	25
	Communications	28
	8130 RTU Communications Cable	30
5	Model 8201 16-Channel Digital I/O	31
	Features	31
	Description	31
	Power source configuration jumper (W1, W2)	32
	External Power Connector (J1, J3, J5, J7)	32
	Field Wiring termination block (J2, J4, J6, J8)	33
	Plug-In Modules	33
	DC Input Modules	33
	AC Input Modules	34
	DC Output Module	36
	AC Output Module	37
	Software Interface	38
	Plug-In Modules Parts List	38
	Digital I/O Assignment Chart	38
6	8130 RTU Software Blocks	41
	Description	41
	Database Organization	42
	Point Format	42
	Parameter Description	42
	Gathering Point Data	44
	Standard Request-Response Format	44
	Change of State Format	44
	Scanners	45
	Output Registers	46

Modbus Communications	46
Modbus Master	46
Modbus Slave	46
Inherent 8130 RTU Software Blocks	47
Analog Alarm Point (AAL)	48
Analog Inputs (AI)	50
Analog Functions (AIFUNC)	53
Analog Status (AISTAT)	54
Alarm Selector (ALSEL)	56
Byte Register (BREG)	57
Clock (CLK)	57
Command Activator (CMNDR)	58
Communications (COM)	60
Coded Register (CREG)	62
Digital Alarm (DAL)	62
Digital Input (DI)	63
Diagnostic (DIAG)	66
Digital Output (DO)	67
Double Word Register (DREG)	69
Emulator (EMU)	69
EMU Gateway (EMUGW)	70
Floating Point Register (FPREG)	72
Gateway Block (GWBLK)	72
I/O Configuration (IO)	74
Integer Register (IREG)	75
Modbus Gateway (MODGW)	75
Modbus I/O (MFIO)	76
Pulse Totalizer (PTOT)	78
Pump Status/Control (PUMP)	80
Scaler Point (SCALER)	86
Signal Selector (SIGSEL)	87
System Information (SYS)	89
Event Timer/Counter (TIMER)	90
Tag Register (TREG)	92
Unsigned Long Integer Register (ULREG)	92
Valve Status/Control (VALVE)	92
Comm Watchdog (WDOG)	95
7 Using ViewRTU	97
System Requirements	97
Installing ViewRTU	97
Executing ViewRTU	97
ViewRTU Window	99
The ViewRTU Menu Bar	100
The File Menu	100

	The Point Menu	101
	The Config Menu	103
	The Communications Menu	106
	The Options Menu	108
	The Help Menu	110
	Using ViewRTU	110
	Overview	111
	Configuring Single Points	111
	Modifying Values	114
	Configuring Multiple Points	118
	Creating and Editing Connections	124
8	Using Tank Gauge Configurator	127
	Executing the Tank Gauge Configurator	127
	ViewRTU window	128
	The Tank Gauge Configurator Menu Bar	129
	The File Menu	129
	The Point Menu	130
	The Config Menu	131
	The Communications Menu	134
	The Options Menu	136
	The Help Menu	137
	Using Tank Gauge Configurator	138
	Configuring Tank Gauge Configurator Points	138
	Configuring Multiple Tank Gauge Configurator Points	143
	Entering Tank Gauge Configurator Point Data	144
	The Options Menu	147
9	Local Diagnostic Interface	149
	LDI Environment	150
	LDI Screen	150
	LDI Keypad	150
	Navigating the LDI	151
	Help Screens	151
	LDI Functions	151
	Entering a Password	151
	Adding a Point	152
	Deleting a Point	152
	Editing a Point	153
	Listing Points	154
	Edit Tags	154
	Update Mode	155
	Configuring Update Mode	155
	Viewing Update Mode	157

Tank Mode	157
10 Troubleshooting	159
Troubleshooting the 8130 RTU Motherboard	159
LED Displays Under Normal Conditions	159
LED Displays Under Abnormal Conditions	160
Using the 8130 RTU icons	161
Performing a Hard Reset	161
8130 RTU Motherboard Power Adjustments and Verification	162
Power Supply Adjustment	162
Supply Voltage Verification	162
11 Order Codes	165
8130 Remote Terminal Unit	165
Ordering Structure 8130 RTU NEMA 4 Enclosure for use in Class I Div 2 areas	165
Ordering Structure Miscellaneous Options	165
Ordering Structure I/O Module Options	165
Ordering Structure Expansion Modules	166

1 Overview

The 8130 RTU is a member of Varec's complete line of industrial control systems and products. The 8130 RTU is primarily designed for applications where a cost-effective control system is needed for remote collection of field data and control of equipment.

The 8130 RTU is ideally suited for Tank Farm, Terminal, Pipeline, and Refinery applications. It is an effective solution used in SCADA or stand-alone programmable control unit applications.

Features

General

- Complete Computer Control System
- Division II certified system (FM, CSA) (consult factory and Control Drawing)
- Inputs are reported to Host Computer by Exception or Scanned Poll
- Built-in Software Function Library
- Surge Protection Conforming to ANSI/IEEE C37.90a-1974
- Host Communication via RS-232, RS-485, radio, modem or fiber optic link
- Industry Standard Protocols: HART, Modbus, LON, TIWAY
- Stand-Alone Programmable Control
- Built-in Operator Interface
- Variety of I/O Interfaces: AI, AO, DI, DO
- Quick-Disconnect I/O Terminations
- Modular Construction for Optimum Expandability
- Non-Volatile Database, CMOS Memory
- Optional Battery Backup for Uninterrupted Operation
- Intrusion Alarm, Power Fail Monitoring

Applications

- Low, Low-Low, High and High-High alarms
- Pressure, temperature, level, and flow
- Bottom sediment & water (BS&W)
- Pump status & control
- Valve status & control
- Emergency shut-off
- Leak Detection
- Local indication & alarms

Specifications

Memory

- 16-Bit Microprocessor and Support Circuitry

- 516K bytes Program Memory
- 128K bytes Non-Volatile Database Memory

DC Power Requirements

- 5 DC VOLT (worst case), 2 A
- 15 VOLT (worst case), 75 mA
- Combined total (worst case), 12.25 Watts
- 24 VOLT (nominal per active Digital Output), 60 mA
- 24 VOLT (nominal per active Digital Input), 2 mA
- 24 VOLT (maximum per Analog Input),
- 25 mA VOLT (maximum per Analog Output), 22 mA
- Combined total (worst case), 26.7 Watts

AC Power Requirements

- 120 VAC, 400 mA
- 240 VAC, 200 mA

Host/Slave Communications

- Selectable Data Rate, 1200 to 19200 Baud
- RS-232 or RS-485 communications
- RS-485 Maximum Cable Length (24 AWG), 4000 Feet
- RS-485 Maximum Cable Length (18 AWG), 10000 Feet
- RS-485 Maximum Multi-dropped Units, 32

Physical

- 8130 RTU Case: 16"H x 9 1/2"W x 2 1/2"D
- Enclosure: 24"H x 20"W x 6 5/8"D, NEMA 4

Environmental

- Operating Temperature: -40°F to 158°F; -40°C to 70°C
- Storage Temperature: -40°F to 212°F; -40°C to 100°C
- Humidity: 5% to 95% RH non-condensing
- Recommended Enclosure: NEMA 4/12

Digital Inputs

- Maximum Quantity: 32
- Isolation Voltage: 4000 VAC
- Operating Voltage: 24 VDC, 120 VAC or 240 VAC

Digital Outputs

- Maximum Quantity: 32
- Isolation Voltage: 4000 VAC

- Operating Voltage: 24 VDC, 120 VAC or 240 VAC

Analog Inputs

- Maximum Quantity: 32
- Operating Voltage (Single-ended): 0–+10 Volts, ± 5 Volts or ± 10 Volts
- Operating Voltage (Differential): 0–+10 Volts, ± 5 Volts or ± 10 Volts
- Resolution: 12 bits
- Throughput Accuracy: $\pm 0.012\%$
- Sample Rate per channel: 160 msec
- Surge Protection Clamping (max): +28 Volts
- Maximum Input Voltage (1 msec): 1500 Volts peak
- Maximum Input Current (1 msec): 15 Amps peak
- Surge Response Time: 1 picosecond

Analog Outputs

- Maximum Quantity: 32
- Operating Voltage (Single-ended): 0–+10 Volts, ± 5 Volts or ± 10 Volts
- Operating Voltage (Differential): 0–+10 Volts, ± 5 Volts or ± 10 Volts
- Resolution: 16 bits
- Sample Rate per channel: 500 msec
- Surge Protection Clamping (max): +28 Volts
- Maximum Input Voltage (1 msec): 1500 Volts peak
- Maximum Input Current (1 msec): 15 Amps peak
- Surge Response Time: 1 picosecond

Intelligent Communications Interfaces

- Tank Gauge communications via intelligent expansion modules
- Microprocessor-based
- Automatically scans for level, temperature and interface level
- Industry Standard Protocols: Modbus, TIWAY, LON, RACKBUS
- Tank Gauge Interfaces:
 - Varec
 - Whessoe Varec
 - Varec
 - Enraf
 - L&J
 - Saab
 - MTS
 - GSI
 - Texas Instruments
 - Barton Instruments,
 - Veeder Root

Gas Tube Protection

A surge ground is used to provide surge protection for I/O and communications by using a combination of Gas Discharge Tubes and Transzorb. To eliminate surge transients, gas discharge tubes augment the standard on-board surge protection by providing a conductive ground.

Gas tube protection is the standard for Analog Inputs, RS-485 Communications, Tank Gauge Interfaces and Input power. Surge Protection including Gas Discharge Tubes is provided on the following interfaces:

- AC Input
- DC Power Input
- RS-485 Communications
- Model 8203 Dual RS-485 Communication Interface
- Model 8205 16-Channel Analog Input
- Model 8207 8-Channel Analog Output
- Model 8208 TIWAY Interface
- Model 8210 Varec Mark/Space Interface
- Model 8211 Current Loop Interface
- Model 8212 Saab Interface
- Model 8213 V1 Interface (Varec)
- Model 8214 Enraf Interface
- Model 8215 L&J Tankway Interface
- Model 8216 LON Interface (Barton Instruments)

Other features of gas tube protection are listed below:

- Gas Discharge Tube Surge Breakdown, 1200 Volts max
- Gas Discharge Tube DC Breakdown, 500 Volts max
- Maximum Surge Current (10 x 1000 usec), 300 Amps peak
- Maximum Surge Current (10 x 50 usec), 1500 Amps peak
- Impulse Life (300A, 10 x 1000 usec), 80 to 400 Surges

Field Maintenance

Field maintenance of the 8130 RTU is simplified by several built-in features. The modular design of the computer control system, in conjunction with quick-disconnect connectors, allows for on-site replacement of questionable components.

A dedicated RS-232 port is also provided for use in diagnostic testing or local programming. Normally, a laptop computer is used for this function.

I/O Expansion Modules

The 8130 RTU can interface to a variety of field devices and intelligent instrumentation via expansion modules. Many diverse products are available to serve a variety of needs. The available expansion modules are listed below:

- Model 8201 16-Channel Digital In-/Out
- Model 8203 Dual RS-485 Communication Interface
- Model 8204 8-Channel Multi-Function
- Model 8205 16-Channel Analog Input
- Model 8207 8-Channel Analog Output
- Model 8208 TIWAY Interface
- Model 8210 Varec Mark/Space Interface
- Model 8211 Current Loop Interface
- Model 8212 Saab Interface
- Model 8213 V1 Interface (Varec)
- Model 8214 Enraf Interface
- Model 8215 L&J Tankway Interface
- Model 8216 LON Interface (Barton Instruments)
- Model 8217 Dual RS-232 Interface

2 Hardware and Software

In addition to the Input/Output functions of the 8130 RTU, several other standard features are provided. These features include a “watch dog” timer, real-time clock, a real-time multi-tasking executive, a built-in software library, data-scanning routines and database management.

The 8130 RTU is designed to be supported by a full range of I/O interfaces. Through these interfaces the 8130 RTU can connect to virtually every type of signal encountered in industrial environments. The 8130 RTU can also interface to Host systems using a variety of system protocols.

Hardware Description

The 8130 RTU consists of an enclosure, power supply, pluggable termination points, high-performance 16-bit microcomputer, communication subsystems and a full complement of analog and digital input/output circuitry.

The basic 8130 RTU is constructed as a Motherboard with connectors for up to four I/O expansion modules. The I/O modules are either single-sized (4.5" by 5.1") or double-sized (4.5" by 10.3"). These modules are described and illustrated in Chapter 5, I/O Expansion Module Configuration. The 8130 RTU motherboard is seen below.

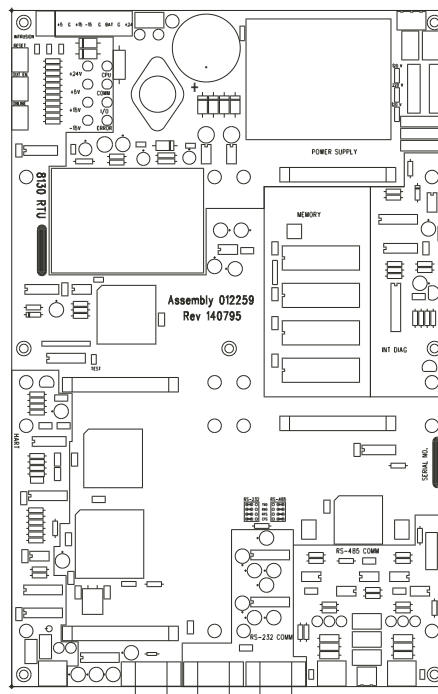

Figure 2-1: 8130 RTU Motherboard

Hardware Block Diagram

A 8130 RTU hardware functional block diagram is shown below. This diagram shows the relationship between major subsystems and components in the 8130 RTU.

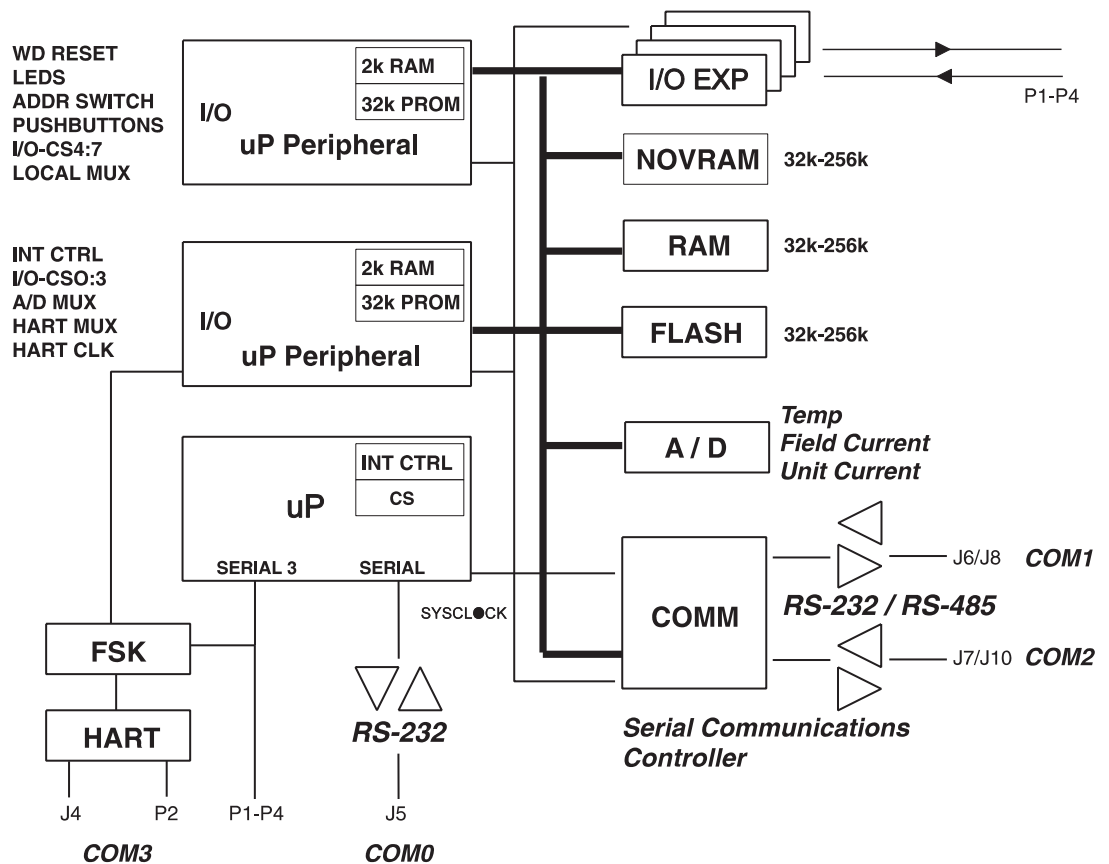

Figure 2-2: 8130 RTU Functional Block Diagram

The heart of the 8130 RTU is an Intel 80C188EB microprocessor operating at 18.432 MHz. Designed specifically for real-time embedded applications, the μ P includes timer/counters, an interrupt controller, and chip-select circuitry. It also includes 2 serial channels that are designated as COM0 and COM3. A separate serial communications controller is used for COM1 and COM2.

Microprocessor peripherals assist in performing on-board I/O functions, as well as providing RAM and PROM. The Boot system is resident in PROM of the μ P peripherals.

Program memory is stored in "flash memory" that allows field upgrades of firmware through the communications channels. The database is stored in up to 64K of nonvolatile RAM. Scratch data, tables and stacks are stored in RAM.

Software Description

The 8130 RTU software platform is based on a real-time, multi-tasking operating system. The software consists of I/O scanning functions for data acquisition, a database/database manager and communication functions for data transfer. The software incorporates a variety of protocols allowing the 8130 RTU to interface as a master or slave device.

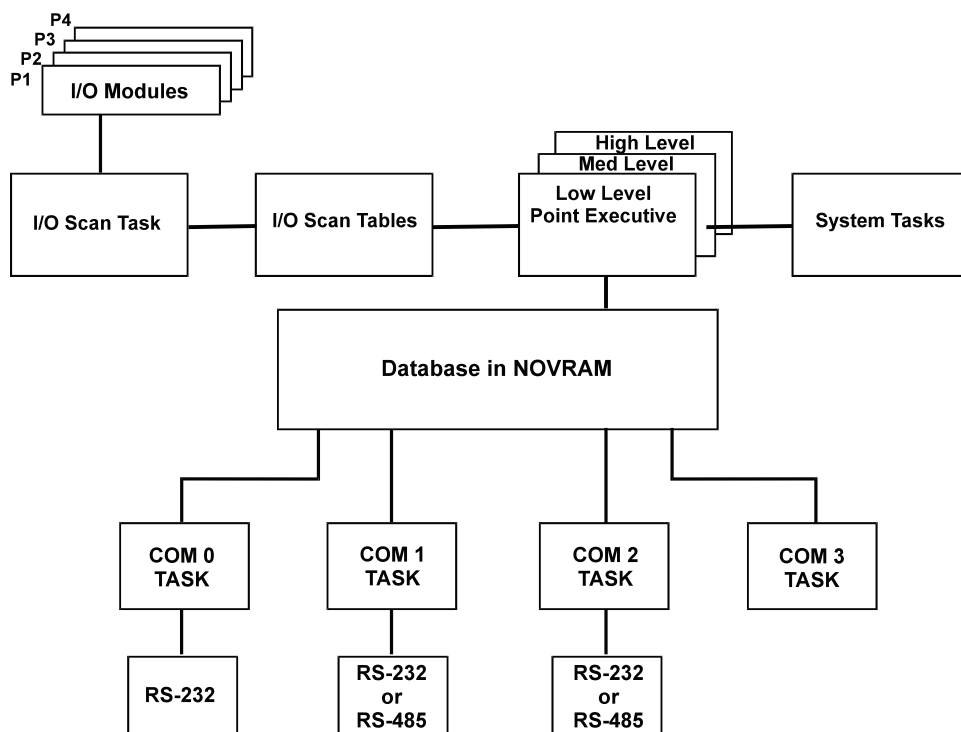

Figure 2-3: Software Block Diagram

Software Features

Real-Time / Multitasking Executive

The operation of the 8130 RTU is based on a highly reliable, field-proven real-time multi-tasking executive. It provides task switching based on real-time events and interrupts, message passing and task priorities. Its capabilities also include timed suspension of tasks, queue handlers and interrupt processing tasks.

Real-Time Clock

Integral to the real-time executive is the system's real-time clock. All timed events of the 8130 RTU are coordinated by this clock. In addition to the real-time executive interaction, all field data scanning is coordinated by the real-time clock. Digital Inputs are scanned at a rate of 20 msec, while Analog Inputs are scanned at a 160 msec rate. Both analog and digital field data are held in temporary storage for later processing by an input task.

Automatic Fault Recovery

The 8130 RTU has a watchdog timer that is periodically strobed by the microprocessor. Should the processor suffer a lapse due to hardware or software failure, the watchdog timer will time out and all Outputs will be disabled. The 8130 RTU will then be reset and normal operation will resume.

Firmware

The 8130 RTU firmware is implemented using “Flash RAM” technology. The firmware can be updated via the Host communications interface. This capability allows for future field installation of product enhancements. As new features are released, the user can download new firmware using the ViewRTU program without having to replace PROMS. Refer to Chapter 7, Using ViewRTU for a description of the firmware download feature.

Communications

There are four communications tasks – one for each of the four communication channels. COM ports 0 through 3 are used to interface to external devices or host systems. Refer to Chapter 4 for the location of these ports.

COM0

COM 0 is an RS-232 port normally used in diagnostic testing or local programming.

COM1 and COM2

COM 1 and 2 can be configured for communications to Host systems using a variety of protocols. For COM 1 and 2 the communication interfaces include the following:

- RS-485 for use in multi-drop configurations
- RS-232 for flexibility in configuring other types of communications links such as radio and fiber optic interfaces
- RTS/CTS lines are available for hardware handshaking.

COM3

COM 3, the fourth COM port, is used for parallel processor communications. These communications are used when an intelligent module such as the Model 8203 or 8210 has been attached to the motherboard. Refer to the individual intelligent module manuals for more information.

Protocols

The 8130 RTU is fully compatible with FuelsManager® software. It is also compatible with a variety of other Host systems including through Modbus protocols. Several types of protocols are available for assignment to the communication ports. As seen in the table below, most of the devices can be assigned interchangeably as the Master or Slave.

Master	Slave
8130 RTU (with the 8203, 8208, 8210, 8211, 8212, 8213, 8214, 8215, 8216, or 8217)	8130 RTU (with FuelsManager® or ViewRTU)
TIWAY	Modbus
Modbus	

For example, if FuelsManager® is used with the 8130 RTU, then FuelsManager® is the master and the 8130 RTU is the slave. The 8130 RTU is the master when intelligent I/O expansion modules are used.

The default communication settings for the COM ports are as follows:

COM Port	Protocol	Baud Rate	Data Bits	Parity	Stop Bits
COM0	8130 RTU Slave	9600	8	N	1
COM1	8130 RTU Slave	19200	8	N	1
COM3	8130 RTU Slave	19200	8	N	1
COM4	8130 RTU Slave	24000	8	N	1

I/O Scanning Task

The I/O Scanning and Control Task are dedicated to the scanning of field input data from analog, digital and pulse sources.

Type of Data Source	I/O Expansion Module
Analog data	Models 8204 and 8205
Digital data	Model 8201 and 8204
Pulse data	Model 8204

The input data is stored in arrays that are subsequently accessed by the Point Executive.

Point Executive

The Point Executive handles processing of the built-in 8130 RTU software blocks that are configured by the user. There are two levels of points as listed below:

- Low-Level Point processing task: e.g. Analog/ Digital Input and Output processing
- High-Level Point processing task: e.g. Totalizers, Alarms, etc.

Each level executes independently of the other level. These tasks perform filtering, timed hold-off determination and conversion of the data before it is permanently stored in the database. When it has been determined that a change of state has occurred, other tasks within the system are notified of the change.

Output processing involves receiving notifications of change from the Remote Communications tasks or Local Interface. Once received, the desired output is read from the database, converted to the corresponding field data and then written to the appropriate output. In the case of pulsed Digital Outputs, they are deactivated after the preset time.

Database Manager

The Database Manager is a collection of programs and data. The Database Manager allows the 8130 RTU system executive to access data from the database in an organized and program-independent manner. It resides in non-volatile RAM.

The Database Manager also contains a Database Dictionary. This dictionary describes how the database is organized and also provides information describing how data should be presented to the operator.

After power-up or system reset, a CRC verification of each point in the database is performed. If the CRC does not have a match for the point, then it is disabled and a flag is set indicating that the point is invalid.

System Tasks

System tasks include the Calendar Task, which manages Time and Date functions. Other system tasks include utility routines for checksum calculations, diagnostics, start-up and initialization.

3 Installation

Before attempting installation, review the Safety Precautions below. Installation and maintenance personnel should become familiar with any hazards present as well as any agency requirements before working with any equipment.

General Safety Guidelines

The 8130 RTU is certified to be used in Division II, Class I, Group A – D hazardous locations.

The user should follow safety guidelines provided by the Occupational Safety and Health Administration (OSHA) for additional protection. Information may be obtained from the following sources:

- National Electric Code (NEC)
- National Fire Protection Association (NFPA)
- Instrument Society of America (ISA)
- Factory Mutual Research Corporation (FM)
- Underwriters' Laboratories Incorporated (UL)
- Canadian Standards Association (CSA)

When in doubt about the safety of an area, the user should check with the local safety authorities. Always observe warning signs posted in the area and all labels on equipment.

Installation Safety Guidelines

Never attempt to make voltage measurements within the 8130 RTU in the field.

Maintenance should be performed only by authorized personnel.

Always turn off the power before removing the case cover.

Before installing/repairing any wiring to the 8130 RTU, make sure that the power is turned off at the main circuit breaker or switch. The power switch should be locked in the OFF position and labeled to prevent other personnel from turning the power on during installation.

Before turning on power when installation is complete, make sure the cover of the 8130 RTU case is in place and tightly closed. **NEVER REMOVE ANY COVERS WITHOUT FIRST TURNING OFF THE POWER.**

To prevent shock hazards, the housing of all units should be properly grounded in accordance with the National Electric Code. A grounding conductor should be wired to the grounding terminal provided on the 8130 RTU.

In some applications, a substantial amount of heat is produced by other equipment inside or outside the enclosure. To assist in air circulation, place blower fans inside the enclosure.

To prevent excessive heat, several steps can be taken. For most applications, normal convection cooling will keep the device components in the enclosure within the operating range. Proper spacing of components within the enclosure is usually sufficient for heat dissipation.

Caution should be exercised when entering any area that is posted or otherwise assumed to contain hazardous gases. Always follow the guidelines provided by the Occupational Safety and Health Administration for your own protection.

Caution Do not bring in unfiltered outside air. It may introduce harmful contaminants that could damage the 8130 RTU and components.

Caution Never perform maintenance with power applied.

Installation

Standard systems are shipped with the motherboard and any optional modules not installed, so the 8130 RTU installation procedure includes the installation of these individual components. 8130 RTU installation includes the following steps:

1. Mounting the 8130 RTU
2. Mounting the Enclosure
3. Wiring up Power
4. Grounding the 8130 RTU
5. Installing Communications
6. Configuring I/O Expansion Modules

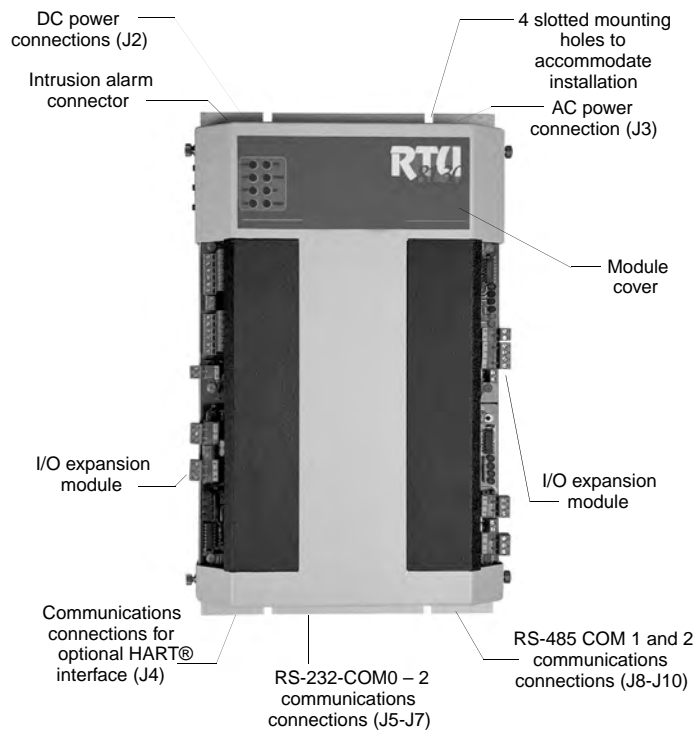

Figure 3-1: 8130 RTU with Two Communications Boards

Mounting the 8130 RTU

Before mounting the 8130 RTU, make certain that the enclosure can house the 8130 RTU. Refer to the dimensional drawing below (all dimensions are in inches).

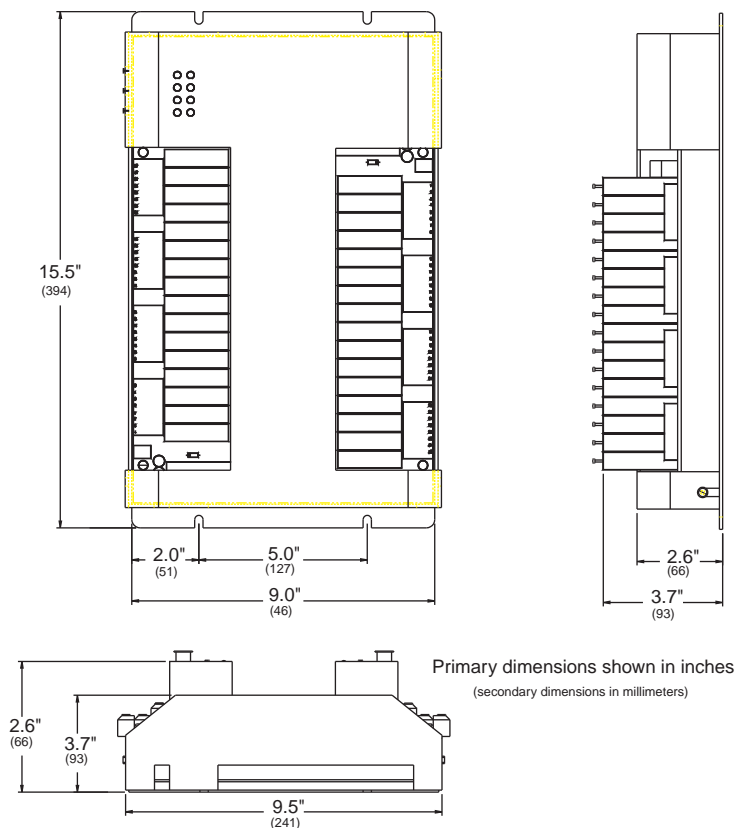

Figure 3-2: 8130 RTU Dimension Drawing

Supplied in the enclosure is a hardware kit for mounting the 8130 RTU Main Circuit Board. The Subpanel has tapped mounting holes to accommodate installation of the 8130 RTU.

Mounting the 8130 RTU inside the enclosure.

- Mount the 8130 RTU onto the subpanel using the 6-32" x 0.5" panhead screws.
- Select the appropriate Unit address on SW1, the Device ID DIP Switch.

Switch SW1 sets the 8130 RTU's one byte, binary address (0-255). Switch SW1-1 is the most significant bit (MSB) while switch SW1-8 is the least significant bit (LSB). When a switch is in the ON or CLOSED position, the resulting bit is a one.

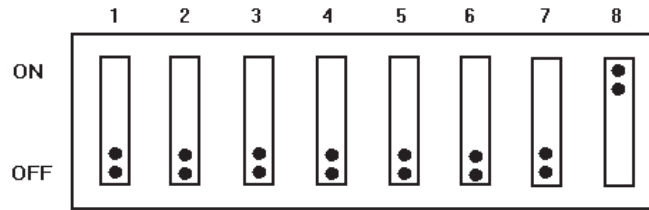

Figure 3-3: Switch SW-1 setting for ID 1

Mounting the Enclosure

The recommended standard housing for the 8130 RTU is a NEMA TYPE 4 enclosure. This enclosure is suitable for both indoor and outdoor applications.

Wiring Up Power

The user has the option of either connecting to AC or DC power.

Wiring 120 or 220 VAC Power

The 8130 RTU is powered by an isolation transformer with a 24 volt regulator.

1. Remove cover.
2. Connect the two power leads to terminals L and N of connector J3.
3. Ensure that a ground connection is connected to the G terminal ground of connector J3.
4. Install cover.

Wiring 24 VDC Power

1. Connect +24V to terminal 8 of connector J2.
2. Connect +24V Common to terminal 7 of connector J2.
3. Connect earth ground to the G terminal ground of connector J3.

Grounding

To allow use in harsh industrial environments, the 8130 RTU incorporates ANSI/IEEE surge protection. In solid-state control systems, grounding helps limit the effects of noise due to electromagnetic interference (EMI) and provides additional surge protection when high voltage switching circuits are connected to the unit. The grounding path for the 8130 RTU and its enclosure is provided by the equipment grounding connector.

Grounding connector

- The 8130 RTU enclosure is supplied with a ground bar at the base of the unit.
- A 14 AWG copper wire should be connected between this ground bar and a good earth ground before connecting any other wires.
- The resistance from the 8130 RTU ground to the grounding electrode must not exceed 1 ohm. Additional ground wires should be connected as required for each I/O module.

Caution All applicable codes and ordinances must be observed when wiring the 8130 RTU.

Installing Communications

RS-232 Communications

To install the RS-232 communication option, connect an RS-232 cable to connector J5 (COM0), J6 (COM1), or J7 (COM2).

Note When using COM1 and COM2, jumper blocks W6 and W7 must be set for RS-232 mode. See the Model 8217 Dual RS-232 Interface manual for more details.

RS-485 Communications

To install the RS-485 communications option, connect a single twisted wire pair to J8 (COM1) or J10 (COM2).

Note When using COM1 and COM2, jumper blocks W6 and W7 must be set for RS-485 mode. For more information, see the “Communications” section on page 28.

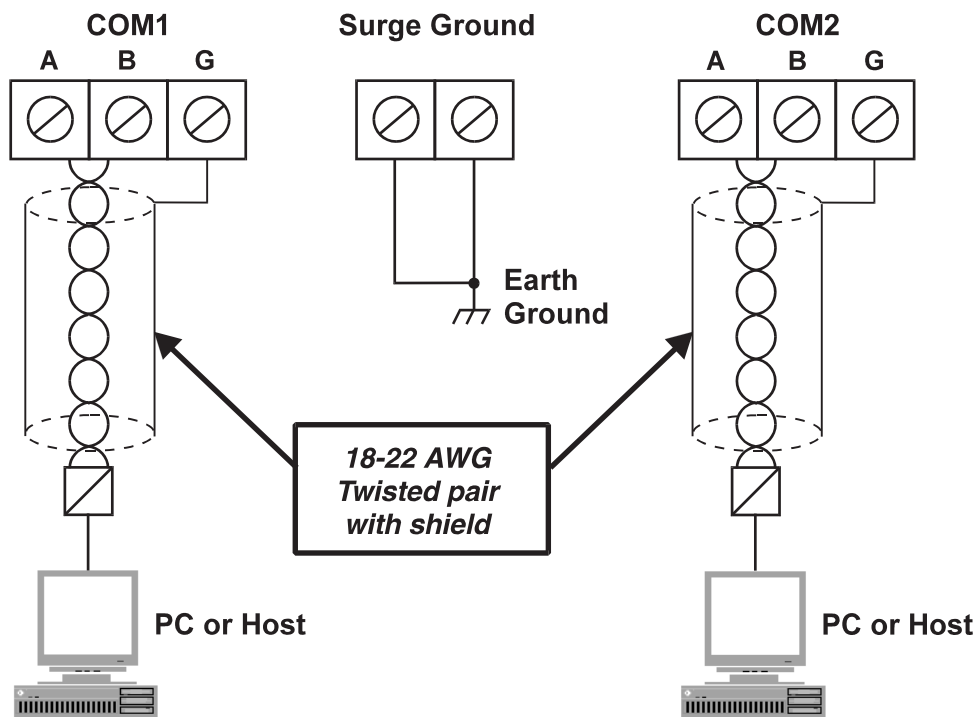

Figure 3-4: RS-485 Communications Connections

Power-Up

Before the field cables are attached, perform an initial system verification.

Initial system verification

- Connect the power cable to power connector P1, then connect an RS-232 cable from a PC with ViewRTU to J5 (COM0).
- Power up the unit.

The CPU indicator should flicker, and the PC should display the sign-on message that provides the software version number, the date and time it was created. If the CPU indicator is not

flickering or the PC does not display the sign-on message, turn off system power and proceed with the Troubleshooting and Calibration chapter.

Establishing Host Communications

When the main system power is turned on, the Host communications status is set to On-line by default. The 8130 RTU then waits for a valid poll from the Host computer. If the communication cable is installed and the Host is running, a communications link is established. Verify this condition with a hand-held terminal or ViewRTU.

Verifying Host Communications

Display the COM Point and verify that an On-line condition is indicated.

Configuring I/O Expansion Modules

The 8130 RTU is supported by a full range of I/O interfaces. I/O expansion modules are available for connection to almost every type of signal encountered in industrial applications.

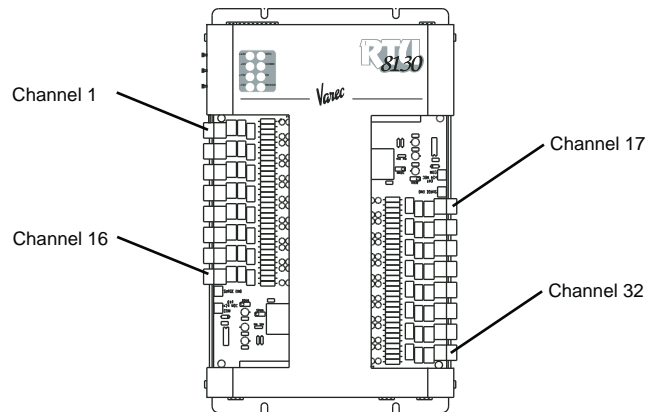

Figure 3-5: Example of a Module Installation

Refer to the Configuration & I/O Expansion Module Configuration chapters (4 and 5) for procedures.

Note Before configuring any I/O expansion modules, 8203, 8208, 8210, 8211, 8212, 8213, 8214, 8215, 8216, and 8217 the dip switch must be set equal to the number to which it is connected on the 8130 RTU (i.e. P1, P2, etc.).

Note Before configuring any I/O expansion modules, each module must always be installed with the terminal blocks facing outward.

Recommended Maintenance Procedure

The following standard procedure can be used for repairing the 8130 RTU:

Replacing a defective component or module

1. Turn off main power.
2. Open the enclosure door. Remove the case cover of the 8130 RTU.

3. Replace the defective component or module.
4. Replace and tighten the case cover.
5. Turn on power and test with Hand Held terminal or main computer.
6. Close the enclosure door.

4 Configuration

The 8130 RTU is supported by a full range of I/O interfaces. I/O expansion modules are available for connection to almost every type of signal encountered in industrial environments. Since wiring to field devices depends on the I/O expansion module, the procedure will vary for each device. The basic 8130 RTU is constructed as a Motherboard with connectors for up to four I/O expansion modules.

Note Refer to the 8130 RTU Installation chapter for guidelines and procedures for using the 8130 RTU in a hazardous location.

Note The channel numbering will usually be the same regardless of the I/O expansion board. Channel 1 begins with the top left connector and Channel 17 begins with the top right connector.

The I/O modules are either single-sized (4.5" by 5.1") or double-sized (4.5" by 10.3"). The I/O expansion modules are listed below:

- Model 8201 16-Channel Digital In-/Out module (contacts, relays)
- Model 8203 Dual RS-485 Communication Interface module (Modbus, MTS, PetroSense)
- Model 8204 8-Channel Multi-Function module (contacts, relays, Pulse Totalizer, Analog inputs)
- Model 8205 16-Channel Analog Input module (4-20 mA, 1-5V)
- Model 8207 8-Channel Analog Output module (4-20 mA, 0-20 mA, 1-5V)
- Model 8208 TIWAY Interface module (Texas Instruments (IT-111, IT-121, IT-150))
- Model 8210 Varec Mark/Space Interface module (Mark/Space Micro 4-wire Model 1800, Model 1900, Model 4000, 2900 FTT)
- Model 8211 Current Loop Interface module (Whessoe Bus Protocol, GPE Protocol)
- Model 8212 Saab TRL/2 Interface module
- Model 8213 V1 Interface module (Varec TGM 3000, TGM 4000, Varec SG6000)
- Model 8214 Enraf Interface module (Enraf 811, 802/812, 854, 873)
- Model 8215 L&J Tankway Interface module (MCG 1000, MCG 1500, MCG 2000)
- Model 8216 LON Interface module (Barton Instruments Series 3500)
- Model 8217 Dual RS-232 Interface module

Configuration instructions for each I/O expansion board can be found in the following relevant chapters.

Motherboard Description

The motherboard description is broken into three sections. Each section identifies the location of the components on the motherboard. When necessary, a brief description of the component is provided. These sections are listed below:

- Power Supply
- Switches and Indicators
- Communications

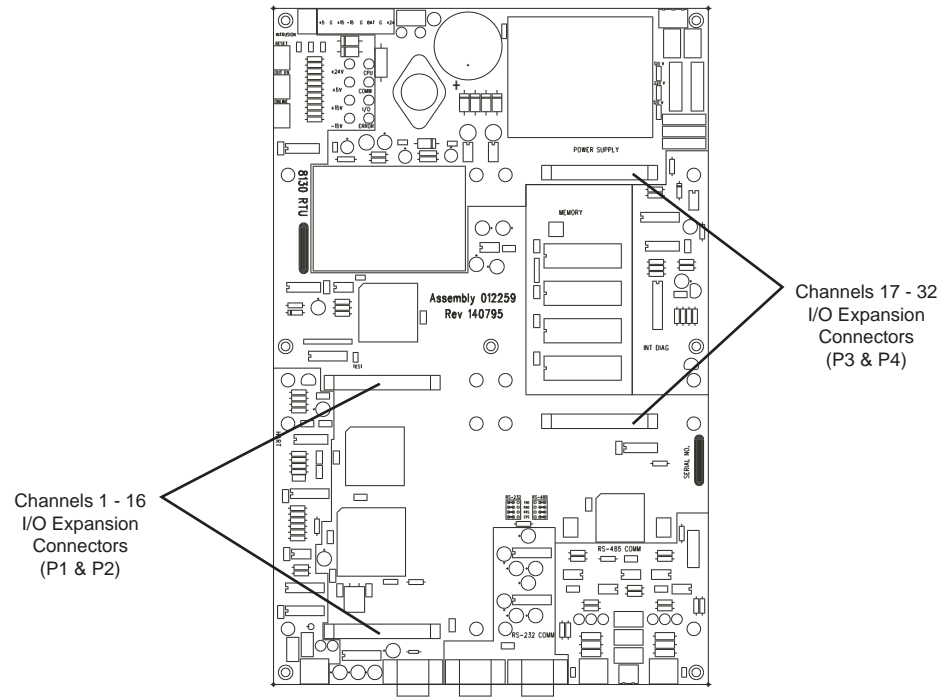

Figure 4-1: 8130 RTU Motherboard

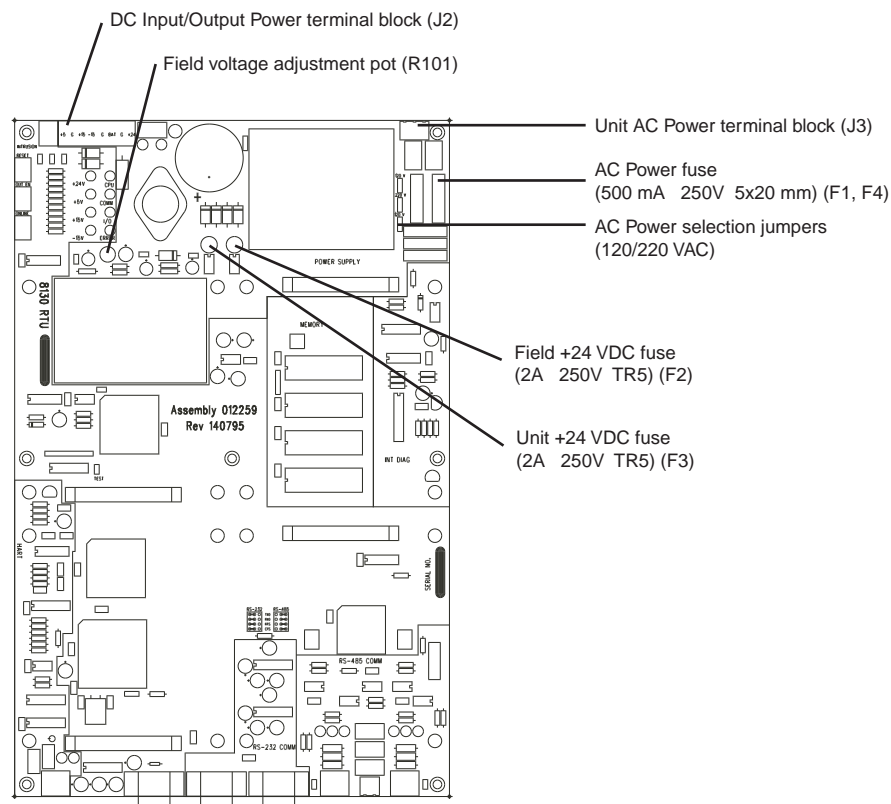

Figure 4-2: Motherboard Power Supply Components

Power Supply

- Field voltage adjustment pot (R101)
- DC Input/Output Power terminal block (J2)
- Unit AC Power terminal block (J3)
- Unit +24 VDC fuse (2A 250V TR5) (F3)
- Field +24 VDC fuse (2A 250V TR5) (F2)
- AC Power fuse (500 mA 250V 5x20 mm) (F1, F4)
- AC Power selection jumpers (120/220 VAC)

Field Voltage adjustment pot (R101)

The field voltage is one of two power supplies found in the power supply subsystem. This component is used for setting and calibrating 24 VDC field voltage. This supply provides field power for Digital Outputs, Digital Inputs and Analog current loops. It is rated at 1.2 Amps.

DC Input / Output Power terminal block (J2)

The DC power terminal block is used when powering the unit from a DC source or battery backup. This terminal block can also be used when external equipment must be powered from the 8130 RTU's internal power supply. The triple output power supply provides +5, +15 and -15 Volts. These are rated 2.0, 0.4 and 0.4 Amps, respectively. Each supply is enabled by a jumper. The DC Power terminal block is shown below:

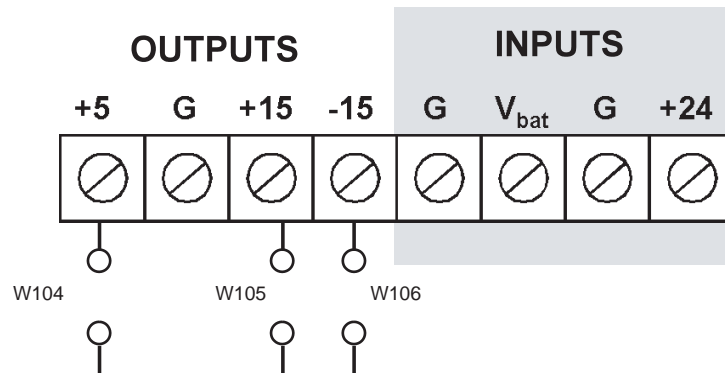

Figure 4-3: DC Input Voltage Terminal Block

The 8130 RTU can be equipped with an optional battery backup system and a built-in recharge circuit. This backup system allows the 8130 RTU to continue to operate for up to 8 hours if AC input power fails.

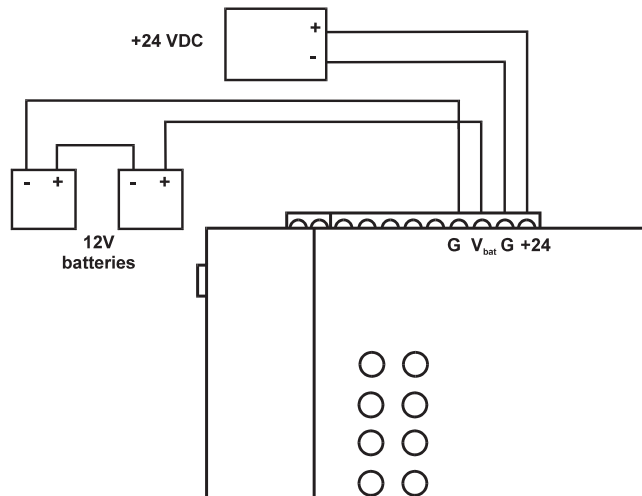

Figure 4-4: 8130 RTU Battery Connection

Unit AC Input Power terminal block (J3)

The Unit AC power terminal block is used to provide 110/220 VAC to the unit. The AC Input Power terminal block is shown in the figure below.

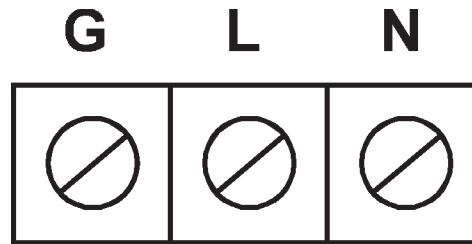

Figure 4-5: AC Input Terminal Block

AC Power Selection Jumpers (120/240 VAC)

The AC Power Selection jumpers are used to select 120/240 VAC for unit power

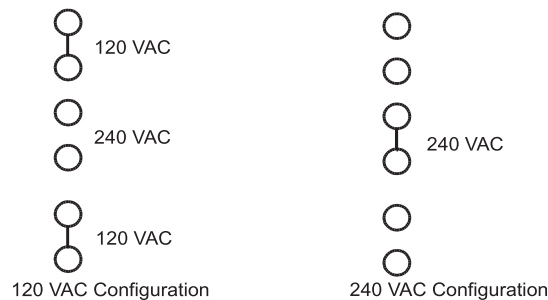

Figure 4-6: 120/240 VAC Configurations

MOVs and Gas Tubes

When changing an 8130 RTU from 120 VAC to 240 VAC or vice versa, the surge protection components (MOVs 2102 – 2104 and Gas Tubes GT101 & GT102) must be changed to match the input voltage.

Switches and Indicators

Note Troubleshooting methods using switches and indicators are discussed in the Troubleshooting chapter of this manual.

- Reset push-button [RESET] (SW2)
- Unit ID DIP Switch (SW1)
- Intrusion Alarm Connections terminal [INTRUSION] (J1)
- LED indicators

Reset push-button (SW2)

The RESET Switch is used to re-initialize the system hardware by causing it to go to a known starting state. This switch may be pressed at any time; however, it will do the following:

- Re-initialize System Hardware
- Clear Scratch Memory
- Verify Database and Re-initialize if Invalid

- Reset All Timers and Schedules
- Enable Communications

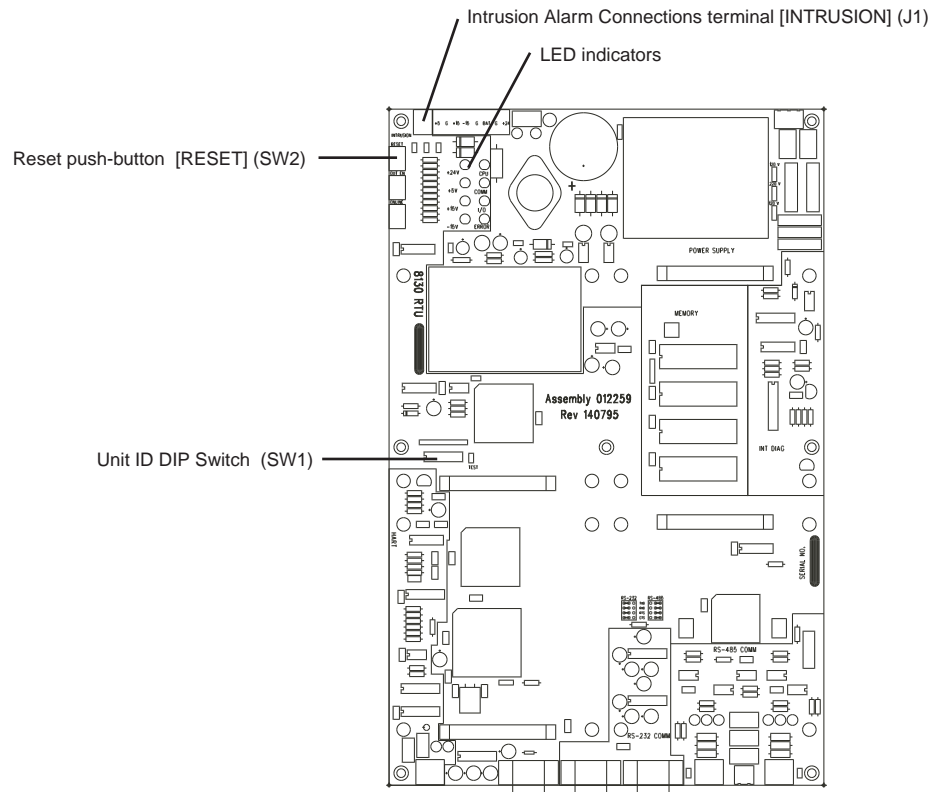

Figure 4-7: Switches and Indicators Components on the 8130 RTU Motherboard

Hard Reset

A special form of Reset is available for occasions when the battery backed-up data base must be re initialized. This type of reset, the Hard Reset, can be performed before a database is downloaded from a host PC.

Caution The Hard Reset should be used as a last resort if the 8130 RTU is not functioning. A Hard reset clears the installed database.

For the Hard Reset procedure, refer to the Troubleshooting and Calibration chapter.

Unit ID DIP Switch (SW1)

The DIP switch is used for setting the 8130 RTU Unit Address, which is used in Host-8130 RTU communications. The Unit Address is a binary value, with switch 8 as the Least Significant Bit (LSB).

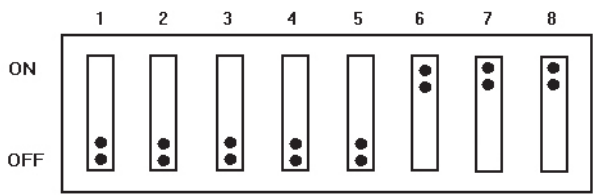

Figure 4-8: 8130 RTU DIP Switch Setting – Showing a Value of 7

Intrusion Alarm Connections terminal (J1)

This terminal is used to connect to a switch on the 8130 RTU enclosure door. The door switch, or Intrusion Detection Alarm, is composed of a set of contacts connected to a lever-actuated switch.

The switch is mounted so that the opening of the enclosure door will generate a contact closure. This contact is attached to a built-in Digital Channel dedicated to Intrusion Detection.

Caution The status of the Intrusion Alarm is available in the DIAG software block. Refer to the 8130 RTU Software Blocks chapter for more information.

LED indicators

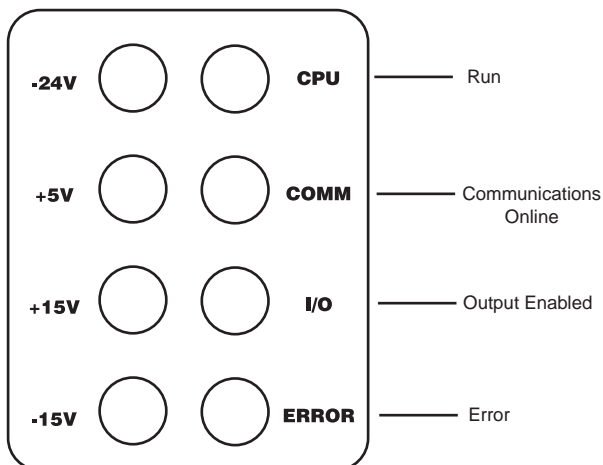

Figure 4-9: 8130 RTU LED Indicators

Run LED

The RUN LED provides the single most important feedback of proper system operation. When the system functions properly, the RUN Indicator is constantly flashing.

If this indicator goes to a steady state condition, either on or off, some malfunction has occurred. In addition, relative processor utilization can be determined by observing the RUN Indicator duty cycle. Under normal conditions, the RUN Indicator flashes once every second.

Communications On-line LED

The Communications On-line LED provides communication line status. The On-line LED will toggle each time a valid message is received.

Output Enable LED

The Output Enable LED indicates the 8130 RTU Motherboard is communicating with the I/O modules.

Error LED

The Error LED indicates that either a CPU or memory fault has occurred.

Voltage LED

The +24V, +5V, +15V -15V Led indicate that the corresponding voltage signals are present.

Communications

The Communications installation requires connection of the appropriate communication cable to one of six connectors. The available options include the RS-232 and RS-485 communications.

- COM1 jumper block (W6)
- COM2 jumper block (W7)
- COM0 (J5)
- COM1 (RS-232) (J6)
- COM2 (RS-232) (J7)
- COM1 (RS-485) (J8)
- Surge ground (J9)
- COM2 (RS-485) (J10)

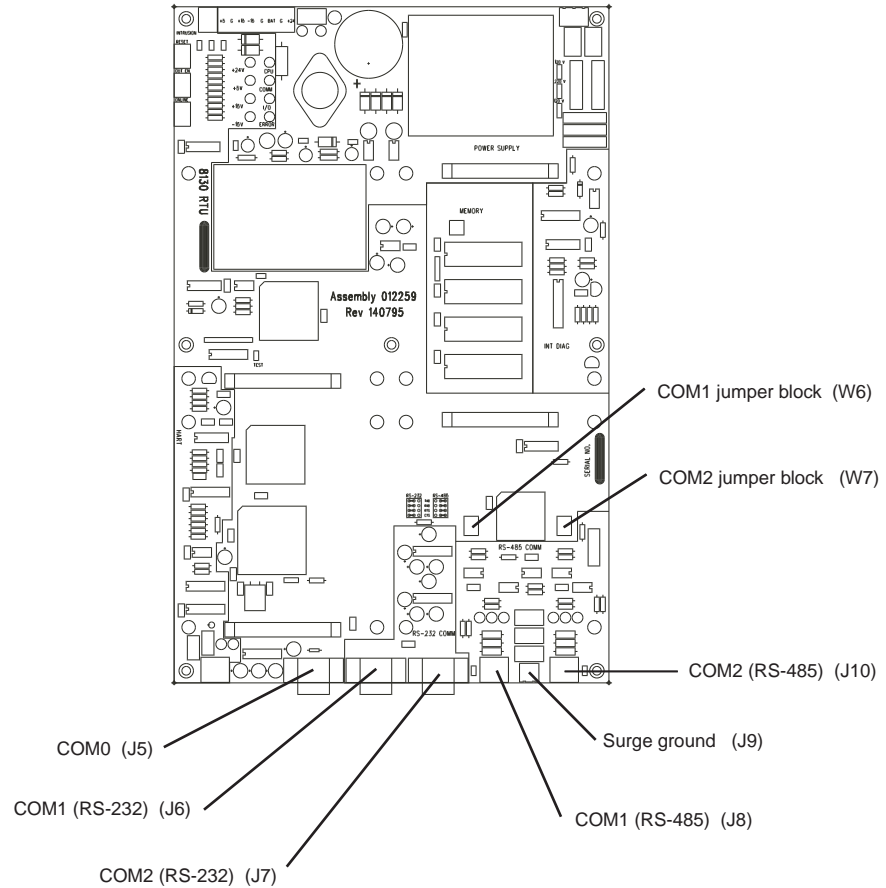

Figure 4-10: Communication Components of the 8130 RTU Motherboard

COM1 and 2 jumper blocks (W6, W7)

W6 and W7 determine whether RS-232 or RS485 is used. For RS-232, there are two different settings. One setting is used if hardware handshaking (RTS/CTS) is required. The other setting eliminates the need for hardware handshaking. Use RTS/CTS when a modem or signal converter is involved and requires RTS/CTS to operate. If the connection is direct using RS-232, jumper RTS to CTS. Refer to the following jumper block diagrams. These jumper settings are used for both COM1 and COM2.

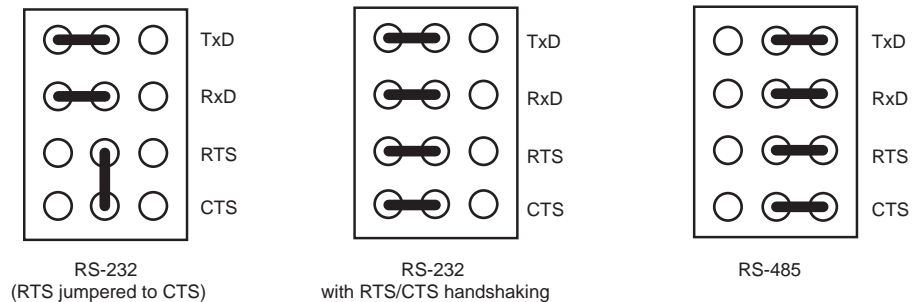

Figure 4-11: Jumper Block Configurations for COM1 and COM2

COM0 (J5)

COM0 is an RS-232 port for use in diagnostic testing or local programming. The protocol defaults to 8130 RTU Slave at the 9600 baud, 8 data bits, and no parity. COM0 is typically connected to a PC running ViewRTU.

COM1 & 2 (RS-232) (J6, J7)

RS-232 is one of the two types of high-speed serial communications channels available to interface to Host or Slave systems using a variety of industry standard protocols. Both COM1 and COM2 may be used simultaneously for increased throughput and redundancy.

RS-232 can be used for flexibility in configuring other types of communications links. Other variations of RS-232 communications interfaces include radio, modem and fiber optic interfaces. The channels may also connect to different hosts using a variety of protocols. For I/O expansion, one channel can be used for peer-to-peer communications with other 8130 RTU's or master/slave communications to remote I/O.

COM1 & 2 (RS-485) (J8, J10)

RS-485 is the other type of high-speed serial communications channels available to interface to Host or Slave systems. Both channels may be used simultaneously for increased throughput and redundancy.

The RS-485 can be used in multi-drop configurations.

Surge ground (J9)

The surge ground is used to provide surge protection for RS-485 communications by using a combination of Gas Discharge Tubes and Transzorbs. Refer to Chapter 1 for more information about gas discharge tubes.

8130 RTU Communications Cable

The layout for the RS-232 cable between the PC and the 8130 RTU is described in the following table:

PC Connector	DB-9 Female		8130 RTU Connector	DB-9 Male
PIN	Signal	-	PIN	Signal
2	Received Data	-	3	Transmitted Data
3	Transmitted Data	-	2	Received Data
5	Signal Ground	-	5	Signal Ground

5 Model 8201 16-Channel Digital I/O

The Model 8201 has two different revisions: Rev 181194 and Rev 250795. These two versions are NOT compatible. See ViewRTU User Guide Ba009G/03/ae for details on how to configure Rev 181194.

Features

- 16 digital I/O channels
- Optically isolated solid state relays for 24 VDC, 120 or 240 VAC operation
- Each channel individually configurable for Input or Output
- Dedicated status LED
- ANSI/IEEE surge protection
- Dedicated fuse for output modules only

The following figure illustrates how the Model 8201 (rev 250795) appears when installed on the 8130 RTU. The two daughter boards are displayed containing plug-in modules.

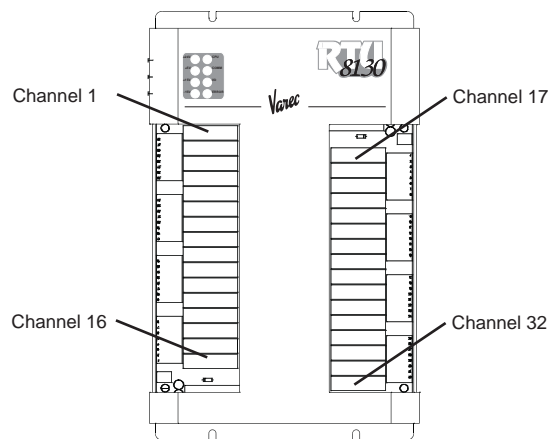

Figure 5-1: 8130 RTU with two Model 8201 16-Channel Digital I/O Expansion Modules (rev 250795)

The two daughter boards are placed asymmetrically on the 8130 RTU. The channel order and number of the 8201 depend upon the placement on the motherboard. Note that the order starts from the top left and ends at the bottom right.

As seen in above channels 1-16 are always located on the left side of the motherboard. Channels 17-32 are found on the right side.

Description

A diagram of the Model 8201 (rev 250795) with plug-in modules is shown in the following figure. This section explains how to connect field wiring and how to configure jumper settings. A thorough description of the allowable I/O plug-in modules has also been included.

- +24V Line fuses (1 A 250V TR5) (F1, F2)
- Power source configuration jumper (W1, W2)

- External Power Connector (J1, J3, J5, J7)
- Field Wiring termination block (J2, J4, J6, J8)
- Plug-in Module (M1 - M16)

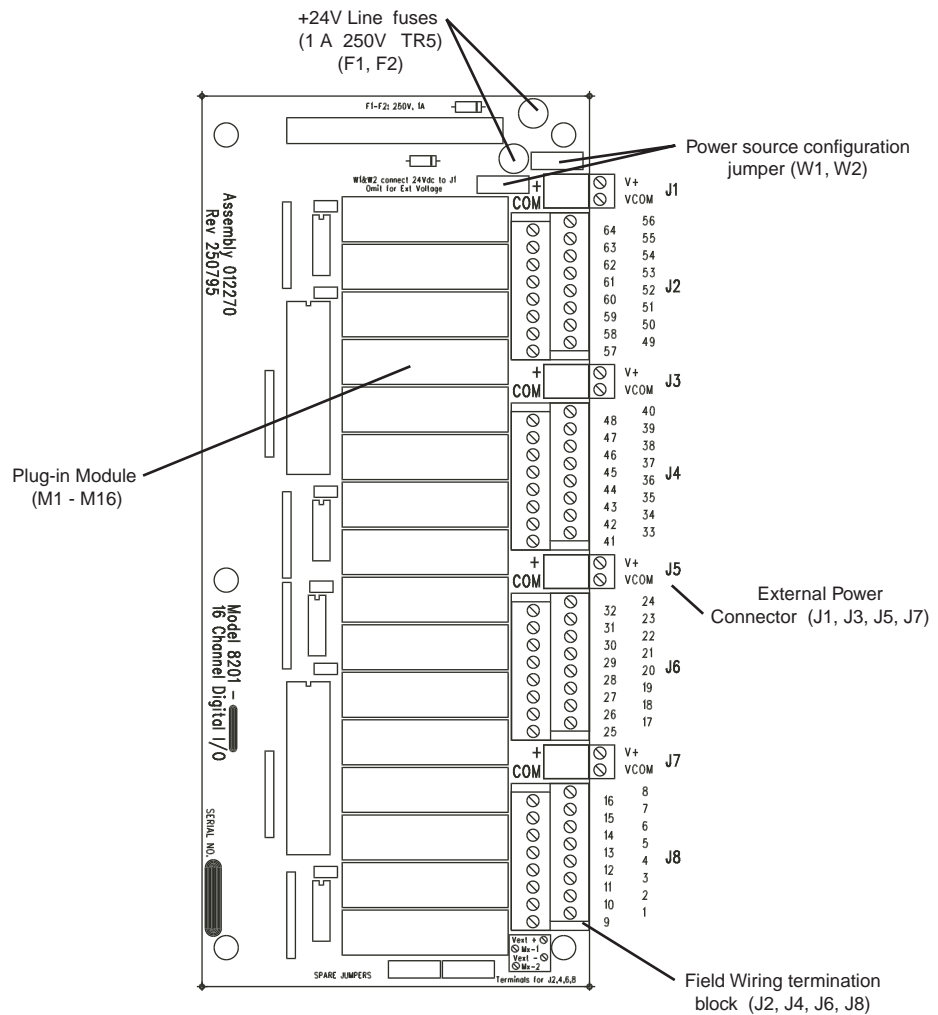

Figure 5-2: 16-Channel Digital I/O Expansion Module

Power source configuration jumper (W1, W2)

To use the +24 VDC available from the 8130 RTU motherboard, insert jumpers W1 and W2.

Caution If using the external power connector, remove the jumpers. If not removed, fuses F1 and F2 will blow.)

External Power Connector (J1, J3, J5, J7)

The External Power Connector is a connection point to the Power Bus. There are four independent power buses. Either AC or DC power can be used.

Connect the Power Bus to the power source.

Connect the + (or line) to terminal 1 and the common (or neutral) to terminal 2 to connect the Power Bus to the power source.

Note If 120 VAC switched equipment requires a ground connection, a suitable ground should be installed.

Field Wiring termination block (J2, J4, J6, J8)

The Model 8201 (rev 250795) has four termination points per channel. Refer to the provided tables for channel assignments at the end of this section.

Plug-In Modules

Plug-in input and output modules are used for interfacing to field devices. The modules are used in receiving digital signals for data acquisition, as well as monitoring and controlling devices. Four basic types of plug-in modules are supported by the 16-Channel Digital I/O. These module types are listed below:

- DC Output Module
- DC Input Module
- AC Input Module
- AC Output Module

The user can mix and match module types on the same Model 8201 (rev 250795) board. These plug-in modules can be placed at any location on the 8201 board. In order to minimize EMI, the similar module types should be grouped together.

The color of each module identifies the function. The industry standard case colors are listed below:

- DC Input.....White
- DC Output.....Red
- AC Input.....Yellow
- AC Output.....Black

Each plug-in module is described in detail below.

Note Refer to the end of the section for a listing of manufacturers and part numbers.

DC Input Modules

DC input modules are used for sensing ON/OFF DC voltage levels. DC input modules can be selected with filtering on the input and a hysteresis amplifier for high noise rejection as well as for transient free “clean” switching. Modules can provide up to 4000 Vrms of optical isolation between the field inputs and the output side of the circuit.

Application

Typical uses and applications include sensing the presence or absence of voltage or sensing contact closures from sources such as the following:

- Proximity Switches
- Limit Switches
- Selector Switches
- Push-buttons
- Photoelectric Switches
- TTL Compatible Devices

Internal Circuitry

The following figure shows the circuitry of a typical DC input plug-in module.

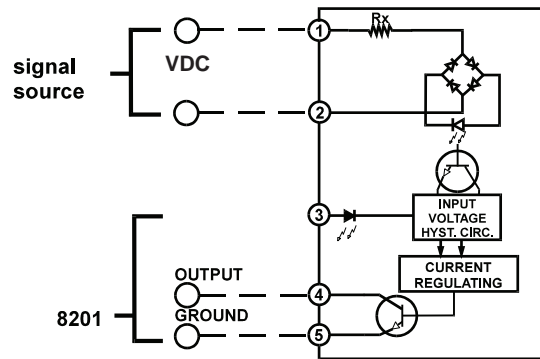

Figure 5-3: DC Input Module Circuitry

Wiring Diagram

The following figures illustrate how the DC input plug-in module is wired to a termination block. Use the appropriate figure in accordance with Assignment chart later in this chapter.

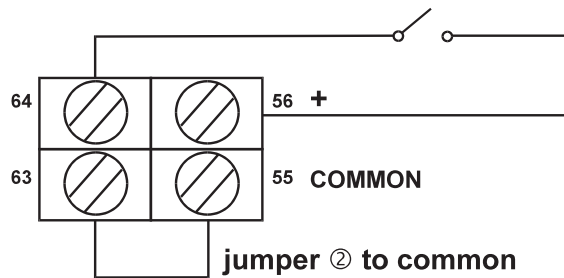

Figure 5-4: DC Input Module Wiring Diagram for Rev 250795

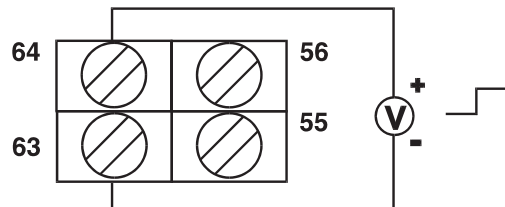

Figure 5-5: A Field Wiring Diagram of DC Voltage Level Sensing

AC Input Modules

AC input modules are used for sensing ON/OFF alternating current (AC) voltage levels. AC input modules can be selected with filtering on the input and a hysteresis amplifier for high noise rejection and transient free "clean" switching. Modules can provide 4000 Vrms of optical isolation between the field inputs and the logic output of the circuit.

Application

Typical uses and applications include sensing the presence or absence of voltage or sensing contact closures from sources such as the following:

- Proximity Switches
- Limit Switches Float Switches
- Selector Switches
- Push-buttons
- Toggle Switches
- Thermostats

Internal Circuitry

The following figure following figure shows the circuitry of a typical AC input plug-in module.

Figure 5-6: AC Input Module Circuitry

Wiring Diagram

The following figures illustrates how the AC input plug-in module is wired to a termination block. Use this figure in accordance with Assignment chart later in this chapter.

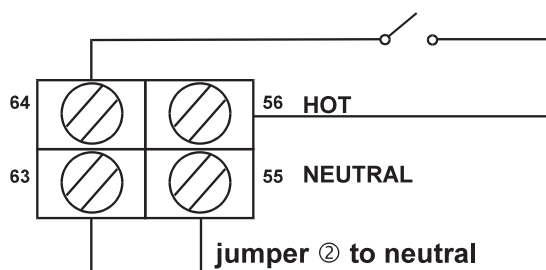

Figure 5-7: AC Input Module Wiring Diagram for Rev 250795

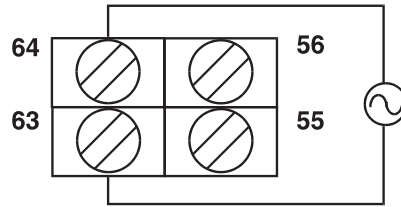

Figure 5-8: Field Wiring Diagram of AC Voltage Level Sensing

DC Output Module

DC Output Modules are used for controlling or switching DC loads. Modules can provide 4000 Vrms of optical isolation between the field devices and the control logic. These modules can operate DC load over a wide voltage range.

Application

Typical uses and applications for DC output modules include switching the following loads:

- DC Relays
- DC Solenoids
- Motor/Pump Starters
- DC Lamps or Indicators

Internal Circuitry

The following figure shows the circuitry of a typical DC output plug-in module.

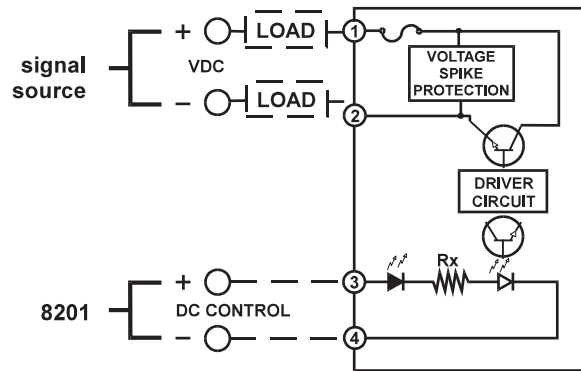

Figure 5-9: DC Output Module Circuitry

Wiring Diagram

The following figure illustrates how the DC output plug-in module is wired to a termination block. Use this figure in accordance with Assignment chart later in this chapter.

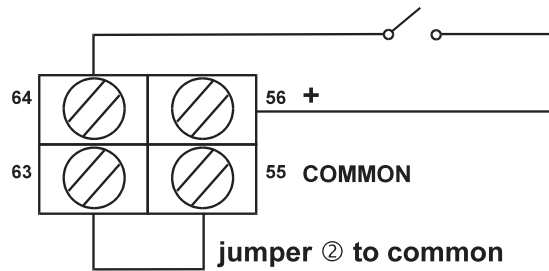

Figure 5-10: DC Input Module Wiring Diagram for Rev 250795

AC Output Module

AC output modules are used for controlling or switching AC loads. Modules can provide 4000 Vrms of optical isolation between the field devices and the control logic. AC output modules are essentially equivalent to a single pole, single throw, normally open contact (FORM A, SPST-NO, Make).

Application

Typical uses and applications for AC output modules include switching the following loads:

- Valves
- Relays
- Solenoids and Contactors
- Motor Starters
- Heaters
- Lamps or Indicators

Internal Circuitry

The following figure shows the circuitry of a typical AC output plug-in module.

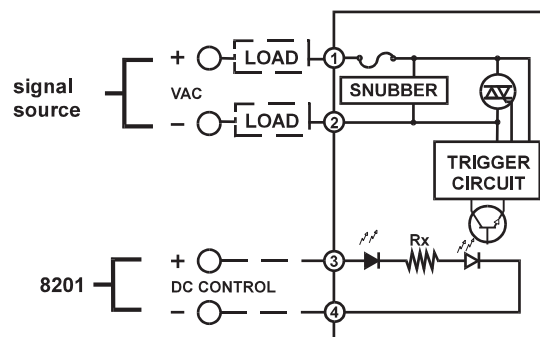

Figure 5-11: AC Output Module Circuitry

Wiring Diagram

The following figure illustrates how the AC output plug-in module is wired to a termination block. Use this figure in accordance with Assignment chart later in this chapter.

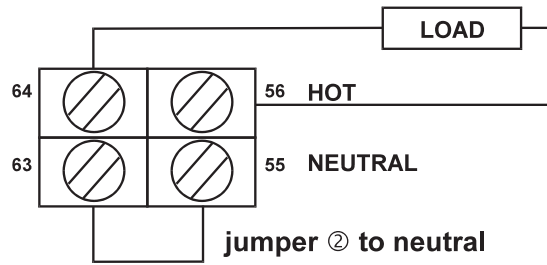

Figure 5-12: AC Output Module Wiring Diagram for Rev 250795

Software Interface

The Model 8201 (rev 250795) is used in conjunction with Digital Input (DI), Digital Output (DO), and Pulse Totalizer (PTOT) points.

The DI point interfaces to discrete input signals such as contact closures and proximity switches. The DO point interfaces to digital output signals such as pumps, valves, annunciators, or any other type of actuators. The PTOT point counts pulse totals from discrete input sources such as the Model 8201 Digital Input/Output Module.

Note Refer to the 8130 RTU Software Blocks chapter for point description and applications.

Plug-In Modules Parts List

Manufacturer	Function	Model #	Ordering #
Opto 22	AC Input	G4IAC5	061387
	AC Output	G4OAC5	061388
	DC Input	G4IDC5	061389
	DC Output	G4ODC5	061390
Grayhill	AC Input	70G-IAC5	061358
	AC Output	70G-OAC5	061368
	DC Input	70G-IDC5	061369
	DC Output	70G-ODC5	061357

Digital I/O Assignment Chart

8130 RTU # _____

Channel	I/O Port	Connector	TERMINAL 1/2	POWER BUS		Service or Description
				+ VDC or AC HOT	DC Common or AC neutral	
1	P2	J8	10 / 9	2	1	
2	P2	J8	12 / 11	4	3	
3	P2	J8	14 / 13	6	5	
4	P2	J8	16 / 15	8	7	
5	P2	J6	26 / 25	18	17	
6	P2	J6	28 / 27	20	19	
7	P2	J6	30 / 29	22	21	
8	P2	J6	32 / 31	24	23	
9	P2	J4	42 / 41	34	33	
10	P2	J4	44 / 43	36	35	
11	P2	J4	46 / 45	38	37	
12	P2	J4	48 / 47	40	39	
13	P2	J2	58 / 57	50	49	
14	P2	J2	60 / 59	52	51	
15	P2	J2	62 / 61	54	53	
16	P2	J2	64 / 63	56	55	
17	P3	J2	64 / 63	56	55	
18	P3	J2	62 / 61	54	53	
19	P3	J2	60 / 59	52	51	
20	P3	J2	58 / 57	50	49	
21	P3	J4	48 / 47	40	39	
22	P3	J4	46 / 45	38	37	
23	P3	J4	44 / 43	36	35	
24	P3	J4	42 / 41	34	33	
25	P3	J6	32 / 31	24	23	
26	P3	J6	30 / 29	22	21	
27	P3	J6	28 / 27	20	19	
28	P3	J6	26 / 25	18	17	
29	P3	J8	16 / 15	8	7	
30	P3	J8	14 / 13	6	5	
31	P3	J8	12 / 11	4	3	
32	P3	J8	10 / 9	2	1	

6 8130 RTU Software Blocks

This chapter describes the Software Blocks that the user can configure using the ViewRTU program. Software Blocks are subprograms used to perform various functions within the 8130 RTU. Each Software Block contains all the logic, constants and data to perform a particular function. For example, the AI Software Block scans the Model 8205 and converts the digital data from the A/D converter to a floating point value. The PTOT Software Block counts pulses from a Model 8204 and calculates the rate and provides a running total. The VALVE software block can be configured to control a valve using a Model 8201 or Model 8204. Other Software Blocks are used to configure I/O scanning and communications to external systems. Every system function of the 8130 RTU is accessible via a Software Block. The user only has to add Software Blocks using ViewRTU and then configure a few parameters in order to perform a desired function.

The purpose of this chapter is to explain the parameters of each software Block. This chapter does not explain the procedures used to configure the Software Blocks. Refer to the following 'Using ViewRTU' chapter for Software Block configuration procedures.

Description

The user can configure pre-defined subprograms known as Software Blocks. These software blocks program the 8130 RTU to perform various tasks, such as scaling an analog input value, or scanning level, temperature and status information from a tank gauge. More than 75 functions are available.

Points are the individual instances of software blocks. At the I/O level, a Point is needed to manage the operation of each input, output or communications channel. I/O can be Simple or Intelligent. Digital Input (DI) and Analog Input (AI) points are examples of Simple I/O. Intelligent I/O always involves digital communications with an external micro-processor based system. Intelligent I/O uses a COM point and a protocol handler in order to communicate with the external system. Examples include Varec 1900 (MSTX) and Whessoe Varec Intelligent Tank Gauge (ITG) points. In both cases the user configures the Config parameters and is provided real time data through the Dynamic parameters.

Points can be interconnected in order to perform complex functions. For example, a PUMP point interfaces to multiple input and output sources (DI, AI, or DO points) in order to monitor and control a pump. The PUMP point can also interface to an Event/Timer (TIMER) point, which can then be used to totalize the pump runtime. Many point descriptions contain an Interfacing to Other Points section that describes how to make these connections.

The Series 8130 RTU contains over 75 built-in software functions depending on the I/O expansion modules installed. Some of these functions are listed below:

- Tank Gauge Scanning
- Protocol Gateway
- Flow measurement/totalization
- Intelligent I/O to other systems
- Digital and Analog alarms
- Analog Scaling
- Pump and Valve control
- Timing/Counting

These functions can be implemented by configuring a Software Block using ViewRTU.

Database Organization

Point Format

Data parameters in the 8130 RTU are addressed using a “Type.Number.Parameter” format. For example, “AI.02.Value” refers to Analog Input #2’s IEEE floating point value. This format and corresponding fields are described below.

The TYPE field represents the Point Type. There are many different point Types in the 8130 RTU, referred to generically as 8130 RTU Software Blocks. Some of the point types include the AI (Analog Inputs), DO (Digital Outputs), and SYS (System) point types. Each Type performs a different function.

The NUMBER field represents the instance of the point type. For example, the AI point may have up to 32 instances, which are addressed using the NUMBER field. Each instance shares the same data structure definition, yet each point has unique data values. In the case of the AI software block, each point manages a single input channel.

The PARAMETER field represents the items in the data structure of the point type. Examples of parameters include Value, Status, PntRef and RawValue. This field is explained in greater detail in the following section.

Parameter Description

Each parameter is defined by its Parameter Class and Data Type. The following subsections describe Parameter Classes, Parameter Data Formats and Common Parameters.

Parameter Classes

Each parameter, such as Value or Channel, is classified as one of the following classes:

Parameter Class	Description
Config	Configuration parameters such as channel numbers, tags, descriptions, ranges, operating modes, point references, constants for formulas and timing information.
Dynamic	Real-time data such as the value or the status. Dynamic data is calculated or measured during point execution scans, which occur every 250 msec.
Command	Output command data.
Constant	Weights & Measures parameter.
Scratch	Temporary data that is typically hidden from the user.
System	System data (should not be changed by the user).

The user-related parameters are the Config, Command and Dynamic parameters. These parameters are available in the Edit Point window of ViewRTU. The remaining parameters are internal to the Software Block.

ViewRTU inserts default values for the Config parameters when the point is first defined. It is usually only necessary to fill in a few configuration parameters, such as channel numbers, to configure references and to configure links to other points.

Parameter Data Formats

Data is stored in the 8130 RTU as one of the following formats:

Data Format	Description
Byte	8-bit value (-127 to 128).
Unsigned Byte	8-bit value (0 to 255).
Coded	Unsigned Integer representing a digital state such as 'On,' 'Off,' 'Open,' 'Closed,' etc.
Integer	16-bit value (-32766 to 32767).
Unsigned Integer	16-bit value (0 to 65535).
IEEE floating point	32-bit value with mantissa and exponent.
Time	Unsigned Long Integer representing the number of milliseconds since Jan. 1, 1970.
Tag	ASCII character strings, variable in length. Used for Tag and Description parameters.
Point Reference	Reference to a point parameter. Format is TYPE.NUMBER.PARAM where TYPE is AI, DI, DO, etc. NUMBER is point number, 0-255. PARAM is the parameter of interest, such as Value or Command. For example: AI.00.Value.
Unsigned Long Integer	32-bit value (0 to 4,294,967,295).
Pointer	32-bit value representing a pointer to another parameter or memory location.
Long Integer	32-bit value.
Integer (Hex format)	Integer in Hex (0x0000 to 0xFFFF).
Time HH:MM:SS	Unsigned Long Integer representing the number of milliseconds since midnight.
Time MM/DD/YY	Unsigned Long Integer representing the number of milliseconds since Jan. 1, 1970.
Unsigned Long Integer (Hex format)	Unsigned Long Integer in Hex (0x00000000 to 0xFFFFFFFF).

Common Parameters

The following parameters are found in almost all point types. These parameters are described below.

PntChecksum Parameter

The PntChecksum is a CRC-16 checksum of the Configuration Parameters of a point. Most points have the PntChecksum parameter; a few like the CLK (Clock) Point, DIAG (Diagnostics) Point, and the register points (BREG, IREG, and DREG) do not. Any time a Configuration Parameter is changed, the 8130 RTU re-calculates the checksum. The PntChecksum is used at initialization to validate each point in the database.

PntStatus Parameter

The PntStatus parameter gives information about point execution. Refer to the information provided for each Software Block about the particular use of the PntStatus parameter.

Elapse Parameter

The Elapse parameter usually indicates the time of the last point execution. It is used as the basis for automatic Change of State notifications.

Value Parameter

The Value parameter indicates the real-time value of the point. In the case of DI points, the Value represents a Coded value (i.e., On, Off, Opened, Closed, etc.) AI points represent the Value in an IEEE floating point format. In most cases, the Value parameter is one of the most important parameters for a point.

Level & Temp Parameters

The Level & Temp parameters indicate the real-time tank level and temperature of the tank gauge point. There are many Software Blocks available in the 8130 RTU associated with tank gauge communications, including Software Blocks for every major tank gauge manufacturer.

Gathering Point Data

For Host to 8130 RTU communications, there are two primary methods for gathering point data. These methods are listed below:

Standard Request-Response Format

The Host issues scan requests, and the 8130 RTU responds with the data.

The Scan method has the advantage of being deterministic the response time to a particular request will always be the same.

This method has the limitation that if there are many points defined in the 8130, it often takes several requests to obtain all of the data. Most of the time data has not changed since the last request, so this results in inefficiencies in update times. This situation is often the case in systems where there are many digital points that do not change frequently.

Change of State Format

The Host issues scan requests based on a Change of State basis. Some systems refer to this as Event Mode. The 8130 RTU keeps track of the items that have changed since the last Host request. The Host can issue a single request of 'tell me what has changed since my last request.' The 8130 RTU will respond with the results, which include addressing information about the data. In a typical system, this results in a significant improvement in the throughput rate for data.

The Change of State method has the advantage of being very efficient, only the data that has changed is reported to the Host.

Change of State-Related Parameters

In order to support the Change of State method, many points have additional configuration parameters included.

Parameter	Description
Value	One of the parameters which will be returned to a Change of State request by the Host. Most Software Blocks are designed so that the Value parameter is the main parameter of interest.
Report	Is used for Change of State processing only. Causes automatic notification to the Host (in response to a Change of State Request) when the Value Changes State. Valid values are High, Low or No. Report=No disables notification. Points with Report = High have higher priority than points with Report = Low.

Parameter	Description
Maxtime	Is used for Change of State processing only. Specifies the maximum time (in secs) between automatic Change of State data being sent to the Host in response to a Change of State Request. When the Maxtime period expires, the Value is forced to appear as if it has changed even if it has not, ensuring that data is sent to the host periodically. Setting Maxtime to 0 disables this option. The maximum is 255 seconds.
Deadband, LevelDeadband, TempDeadband	Affects the Change of State processing. It allows users to filter out insignificant changes, freeing the communications link to send other data.

Note Not all Host protocols support the Change of State method. The 8130 RTU Slave protocol used with FuelsManager supports either method. The 8130 RTU Master protocol used to communicate with other 8130 RTU's or intelligent communication modules (such as the Model 8203 or Model 8210) also supports both methods.

Note The Modbus protocol is Scan-based. Therefore, the Report and Maxtime parameters have no meaning.

Scanners

Scanners are tasks in the 8130 RTU that continuously scan the I/O hardware and store the data in tables.

For Simple I/O, low level point tasks such as the AI, DI and PTOT points continually execute, read data and perform filtering and conversion algorithms. For example, the Analog Input scanner (referred to as AISCAN) reads data from the A/D converter on the Model 8205 every 20 msec and stores the raw data in an array. The AI point executes every 250 msec and uses some or all of the data in the raw data in order to calculate the Value parameter. Likewise, the DI and PTOT points use information collected by the DISCAN task.

For Intelligent I/O, a protocol handler associated with a COM point scans the remote system based upon addressing and timing information provided by the user. For example, the RSCAN point interfaces to Intelligent I/O modules such as the Model 8210 Mark/Space Interface to gather data for MSTX and WV2046 points. On the Model 8210, a MSSCAN point manages the scanning of the tank gauge transmitters and provides status information.

In ViewRTU, the AI, DI and PTOT points are represented by the following symbols:



Figure 6-1: AI, DI, and PTOT Symbols

The data in the scan tables is not directly accessible to the user. Refer to the Analog Alarm Point (AAL) and Digital Alarm Point (DAL) sections for more information on how to use scanner data.

Output Registers

Output Registers are used to control operation of Analog and Digital outputs. The Digital Output (DO) is used to effect a state change on an output channel.

In ViewRTU, the DO point is represented by the symbol:



Figure 6-2: DO Symbol

Modbus Communications

The 8130 RTU is capable of communicating with Modbus compatible devices. It is possible to communicate with both Modbus Masters and Slave devices. The 8130 RTU is flexible, allowing communications with devices that strictly comply with the Modicon Modbus protocol, as well as devices with more advanced Modbus implementations such as Honeywell's APM-SIO.

There are two protocol handlers available with the 8130 RTU. The Modbus Master protocol handler performs scanning of Modbus slave devices. The Modbus Master may reside on the 8130 RTU Motherboard (COM 0, COM 1 or COM 2), or it may run on the Model 8203 Dual RS-485 Interface Module. The Modbus Slave protocol handler responds to read and write requests from a Modbus master system. It is available only on the 8130 RTU Motherboard. A detailed description of the Modbus Master and Modbus Slave protocol handlers follows.

Modbus Master

When connecting to slave devices using the 8130 RTU Motherboard (COM 0, COM 1 or COM 2), the Modbus Master protocol handler is enabled by setting the Protocol parameter of a COM point to Modbus Master. For the Model 8203 Dual RS-485 Interface, the Modbus Master is automatically enabled. An MSCAN point is automatically created to provide user access to the operation of the protocol handler. The Modbus Master protocol handler uses Modbus Integer Register Software Blocks (MIREG) and Modbus Floating Point Register points (MFPREG) to scan data from Modbus slave devices. Each MIREG and MFPREG point is responsible for communicating to a slave device. For each slave device being scanned, there must be a corresponding MIREG or MFPREG point. Multiple points may be used to scan a single device.

The user specifies data addresses and block sizes for requesting data from slave devices. The MIREG and MFPREG points are processed sequentially and data is requested from the slave device.

In addition to the generic MIREG and MFPREG Software Blocks, there are Software Blocks that are customized for Modbus communications to specific devices. These include the MBMFT, MBTX and RTG Software Blocks.

Modbus Slave

The Modbus Slave protocol handler is enabled by setting the Protocol parameter of a COM point to Modbus Slave. The Modbus Slave protocol handler responds to requests from Modbus masters. A MODGW point is automatically created to provide user access to the operation of the protocol handler. The MODGW point also provides dynamic information about the communications requests from the Modbus master.

The Modbus Slave protocol handler is flexible, allowing the user to set options for handling several aspects of Modbus communications. The Modbus Slave uses the GWBLK Gateway Block as a lookup table for data addresses.

The Gateway Block allows the user to specify data address and point reference combinations. This allows the 8130 RTU to be used with an existing system that is already configured. The user defines a GWBLK point and specifies which parameter in the 8130 RTU will be used for a particular address. When a request from a master is received, the Modbus Slave protocol handler will first search for any GWBLK points and determine if the data address of the request is specified in one of the GWBLK points. If the data address is contained in a GWBLK point, then the corresponding point reference is used to provide the data for the reply to the master.

Inherent 8130 RTU Software Blocks

The following sections describe in detail each of the listed points that are embedded in every 8130 RTU. Each section provides instructions on configuring the software block and the applications of the software block.

- Analog Alarm (AAL)
- Analog Inputs (AI)
- Analog Functions (AIFUNC)
- Analog Status (AISTAT)
- Alarm Selector (ALSEL)
- Byte Register (BREG)
- Clock (CLK)
- Command Activator (CMNDR)
- Communications (COM)
- Coded Register (CREG)
- Digital Alarm (DAL)
- Digital Input (DI)
- Diagnostic (DIAG)
- Digital Output (DO)
- Double Word Register (DREG)
- Floating Point Register (FPREG)
- Gateway Block (GWBLK)
- I/O Configuration (IO)
- Integer Register (IREG)
- Modbus Gateway (MODGW)
- Modbus I/O Module (MFIO)
- Pulse Totalizer (PTOT)
- Pump Status/Control (PUMP)
- Scaler Point (SCALER)
- Signal Selector (SIGSEL)
- System Information (SYS)
- Event Timer/Counter (TIMER)
- Tag Register (TREG)
- Unsigned Long Integer Register (ULREG)
- Valve Status/Control (VALVE)

- Comm Watchdog (WDOG)

Analog Alarm Point (AAL)



The Analog Alarm point monitors a floating point value from an AI or any other point type that produces a floating point value. The point activates an output if an alarm condition is detected.

Parameters

The database parameters used by the AAL point are listed and described below.

Configuration Parameters	Function
Tag	A Tag can contain 15 bytes of data and can include any printable ASCII character. Tags can be used to identify points indicating the use of the point such as "High Temp Alarm" or "Hi Level Alarm." The default tag is set to "AAL.00."
Description	The point description can contain 30 bytes of data and can include any printable ASCII character. Descriptions can be used as information relevant to any aspect of the point, such as its use, location, operating information, etc. The default description is set to "AAL.00"
PntRef	Input point reference for the AAL point to monitor. The AAL point interfaces to floating point data values.
ControlRef	Control reference for controlling the operation of the AAL point. The ControlRef is be used to enable/disable the output point link of the AAL point.
OutputLink	Output point Link for the AAL point to control. The AAL point outputs an ON or OFF value.
LoLo	Trip point associated with an alarm condition (Value) of LowLow
Low	Trip point associated with an alarm condition of Low
High	Trip point associated with an alarm condition of High
HiHi	Trip point associated with an alarm condition of HighHigh
Hysteresis	Is used to determine change in alarm state. The RefValue must be in the normal range by an amount more than the Hysteresis for a return to normal to occur
HoldOff	Holdoff time used for determining an alarm condition. The RefValue must be in the alarm range for a period of time greater than the HoldOff for an alarm to occur.
Report	Causes automatic notification to the Host (in response to a Change of State Request) when the Value Changes State. Parameter value can be High, Low or No. Report=No disables notification. Points with Report = High will be sent before points with Report = Low. The default is High.
Maxtime	Specifies the maximum time (in secs) between automatic Change of State data being sent to the Host in response to a Change of State Request. Report must be set to either Low or High for the Value parameter to be sent in response to a Change of State Request. A value of 0 disables this option. Non-zero values cause responses to be sent even if the value has not changed since the last message. The maximum is 255 seconds. The default is 60.
Dynamic Parameters	Function
ResetCmd	A Reset command will deactivate the output. Any change in the Value will re-trigger alarm processing.
Value	Coded value representing the alarm condition. Value can be either Alarm or Normal.

Dynamic Parameters	Function
RefValue	Floating Point value of the PntRef parameter used to determine the Value parameter
OutputCmd	Current command sent to the OutputLink point
Control	This parameter is used to enable/disable the ControlRef's ability to control the AAL output value
State	Hexadecimal value indicating which, if any, alarms are active 0x0001 Low Detected 0x0002 Low Holdoff Passed 0x0010 LoLo Detected 0x0020 LoLo Holdoff Passed 0x0100 High Detected 000200 High Holdoff Passed 0x1000 HiHi Detected 0x2000 HiHi Holdoff Passed
DetectTime	The time the last alarm state occurred
PntStatus	Byte value indicating status of point Values are: 0: No error 15: Invalid Type for PntRef 16 Invalid Number for PntRef 17 Invalid Param for PntRef 19: PntRef point does not exist 25: PntRef is not defined
Elapse	Time of the last Change of State
PntChecksum	CRC-16 Checksum for point's static Configuration Parameters

Application

The AAL point continually monitors the value of the PntRef and then places the data in the RefValue parameter. The RefValue is then compared to the LoLo, Low, High and HiHi parameters. The Value parameter is set according to the following criteria:

RefValue	Value
RefValue <= LoLo	LowLow
LoLo > RefValue <= Low	Low
Low > RefValue < High	Normal
High >= RefValue < HiHi	High
RefValue >= HiHi	HighHigh

The HoldOff is used to determine if an alarm state will occur. When the RefValue first exceeds the alarm limit, a timer is initiated. If the RefValue returns to the normal range before the timer expires, the alarm is "held off." If the RefValue remains in the alarm range for a period greater than the HoldOff value, the alarm state is then set to the appropriate alarm status.

Note To disable the alarm holdoff, set the Holdoff value to 00:00:00.

The Hysteresis is used to determine when the Value in alarm status is returned to Normal status. In order for the Value to return to Normal or to change from higher or lower alarm states, the alarm trip point minus the RefValue must be greater than the Hysteresis parameter. This means that the RefValue must be within the range defined as normal by the amount equal to the

Hysteresis. Setting the Hysteresis value to 0 returns the status to Normal whenever the RefValue is within normal range.

The Control parameter can be used to disable alarm processing. When the Control parameter is set to Enable, alarm processing is enabled. If Control is Disable, then the Value is set to Normal and no alarm processing is done. The ControlRef parameter may be used to automatically update the Control parameter based upon another software block.

The following example graph illustrates the use of the RefValue, LoLo, Low, High, HiHi, Holdoff and Hysteresis parameters.

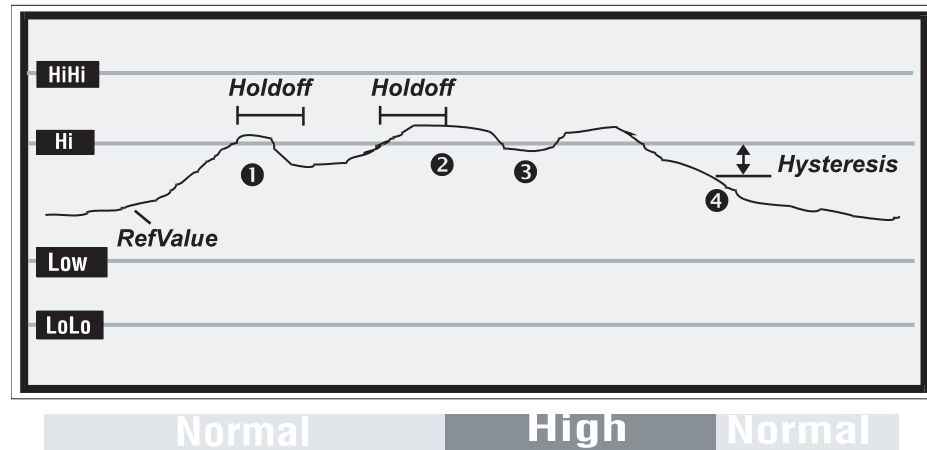

Figure 6-3: Application of the AAL point

1. The RefValue goes into the Hi range but does not pass the Holdoff parameter. The alarm is “held off.”
2. The RefValue remains in the Hi range longer than the defined Holdoff parameter. The alarm state is then set to High.
3. The RefValue dips into the normal range, but the amount does not equal or exceed the Hysteresis parameter.
4. The RefValue returns to the normal range, but this time the amount exceeds the Hysteresis parameter. The status returns to Normal.

Interfacing to Other Points

The AAL point can be used in conjunction with almost any point that produces a floating point data value. Typical examples are the Analog Input (AI) and TankGate points. The typical OutputLink is a Digital Output (DO) point. The ControlRef can be any type of point that produces a parameter value of Enable and Disable. Typical examples are Digital Input (DI) and Digital Converter (DICONV) points. The AAL point is not limited to these types of points and can be used to solve a variety of problems.

Analog Inputs (AI)



The Analog Input point interfaces to analog input signals such as temperatures, pressures, flow rates, and levels. The AI point converts the raw data from the A/D or V/f converter into an IEEE floating point format. A software filtering algorithm may be applied to condition noisy signals. The AI point can be used with the Model 8204 Multi-Function Module or the Model 8205 16 Channel Analog Input Module.

Parameters

The database parameters used by the AI point are listed and described below.

Configuration Parameters	Function
Tag	A Tag can contain 15 bytes of data and can include any printable ASCII character. Tags can be used to identify points indicating the use of the point such as "High Temp Alarm" or "Hi Level Alarm." The default tag is set to "AI.00."
Description	The point description can contain 30 bytes of data and can include any printable ASCII character. Descriptions can be used as information relevant to any aspect of the point, such as its use, location, operating information, etc. The default description is set to "AI.00"
Channel	Physical Channel (1-32). A value of 0 disables data scanning for the channel. For multi-channel devices, this is the first channel of the channel sequence. The default is to match the Point Name, i.e., AI.00 = Channel 1.
Mode	Value Conversion Mode: 0: Value is IEEE Real calculated using Offset & Scale (default) 1: Value is Integer calculated using SYS point parameters AinBias & AinScale 2: 0-10 Volt Range 3: 0-5 Volt Range
Offset	Offset value used in IEEE floating point conversion of RawValue to Value. The default is 0.
Scale	Scale value used in the IEEE floating point conversion of RawValue to Value. The default is 100.
ValueMin	ValueMin can be used to clamp the Value to a minimum value. First, the Value is calculated using the Offset and Scale parameters. If the resultant value is less than the ValueMin, the Value is set to the ValueMin. Normally, you should set the ValueMin to the same value as the Offset.
ValueMax	ValueMax can be used to clamp the Value to a minimum value. First, the Value is calculated using the Offset and Scale parameters. If the resultant value is greater than the ValueMax, the Value is set to the ValueMax. Normally, you should set the ValueMax to the same value as the Scale.
Threshold	The Theshold can be used to force the Value to the ValueMin. First, the Value is calculated using the Offset and Scale parameters. Then the ValueMin and ValueMax are applied. If the Value is less than the Threshold, then the Value is set to the ValueMin.
Deadband	Change of State Deadband. When the Value changes by the amount specified by the Deadband, a Change of State will occur and the data will be transmitted to the Host. The Default is 2.
Filter	Input Filter Constant. Specifies the number of samples to use in the Rate calculation. Valid values are 1-10. The default is 1.
Report	Causes automatic notification to the Host (in response to a Change of State Request) when the Value Changes State. Parameter value can be High, Low or No. No disables notification. Points with Report = High will be sent before points with Report = Low. The default is High.
Maxtime	Specifies the maximum time (in secs) between automatic Change of State data being sent to the Host in response to a Change of State Request. Report must be set to either Low or High for the Value parameter to be sent in response to a Change of State Request. A value of 0 disables this option. Non-zero values cause responses to be sent even if the value has not changed since the last message. The maximum is 255 seconds. The default is 240.

Dynamic Parameters	Function
Value	IEEE Floating Point based upon the point's Offset & Scale parameters or Integer conversion of RawValue scaled based upon SYS point's AinBias and AinScale parameters. Mode determines either Floating Point or Integer.
RawValue	12 bit raw data value from the A/D converter.
PntStatus	Byte value indicating status of point. Values are: 0: No Error 1: Overrange 2: Underrange 3: Configuration change 4: Configuration checksum error
Elapse	Time of the last Change of State.
PntChecksum	CRC-16 Checksum for point's static Configuration Parameters.

Application

The Analog Scanner runs every 20 msec and reads the value from the A/D converter. The Analog Scanner data is stored in an array which is then analyzed periodically by the AI point.

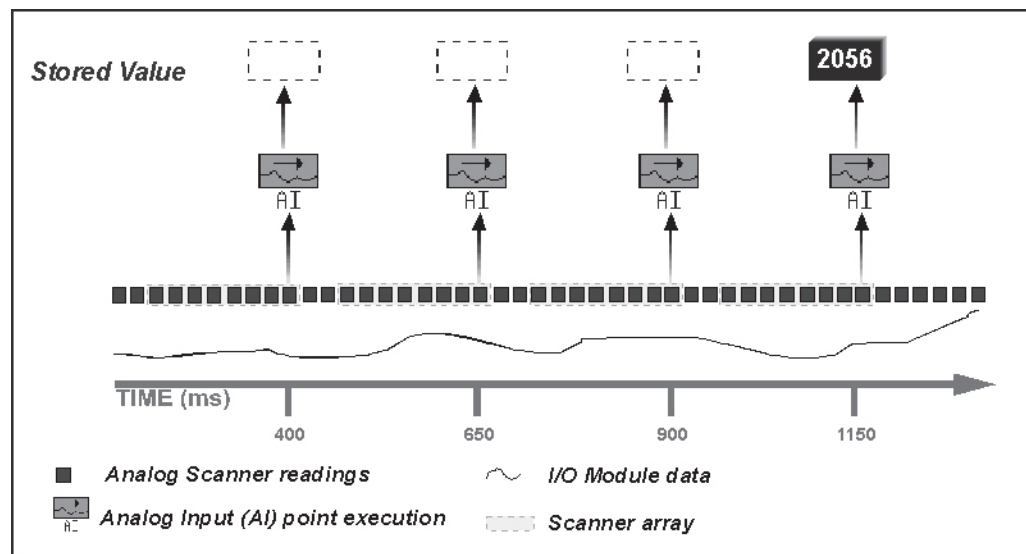

The Filter is applied to the Analog Scanner data array. For example, if the Filter is set to 3, then 3 successive readings are averaged when the Value is calculated.

Interfacing to Other Points

The AI is often used as the input source (a Reference) for other point application programs. The Analog Alarm (AAL), Analog Totalizer (ATOT), Analog Status (AISTAT) and Min/Max/Average (SIGSEL) points are examples of points that use AI point data to calculate other data values or effect control. The Value and the RawValue are the parameters calculated by the AI point which can be used as input in other points.

Analog Functions (AIFUNC)



The Analog Function Point monitors a floating point value from an AI or any other point type that produces a floating point value and calculates a rate of change. Additionally, the AIFUNC point records the daily high and low values as well as the time of high and low occurrence.

Parameters

The database parameters used by the AIFUNC point are listed and described below.

Configuration Parameters	Function
Tag	A Tag can contain 15 bytes of data and can include any printable ASCII character. Tags can be used to identify points indicating the use of the point such as "High Temp Alarm" or "Hi Level Alarm." The default tag is set to "AIFUNC.00."
PntRef	Input point reference for the AIFUNC point to monitor. The AIFUNC point interfaces to floating point data values.
W0-W3	Weight values to factor into the last four samples.
Deadband	Change of State Deadband. When the Value changes by the amount specified by the Deadband, a Change of State will occur and the data will be transmitted to the Host. The default value is 0.1.
Report	Causes automatic notification to the Host (in response to a Change of State Request) when the Value Changes State. Parameter value can be High, Low or No. No disables notification. Points with Report = High will be sent before points with Report = Low. The default is High.
Maxtime	Specifies the maximum time (in secs) between automatic Change of State data being sent to the Host in response to a Change of State Request. Report must be set to either Low or High for the Value parameter to be sent in response to a Change of State Request. A value of 0 disables this option. Non-zero values cause responses to be sent even if the value has not changed since the last message. The maximum is 65525 seconds. The default is 60.
Interval	Interval for scanning of the PntRef. The interval parameter is presented in HH:MM:SS format. The default is 5 seconds.
Filter	Input Filter Constant. Specifies the number of samples to use in the Rate calculation. Valid values are 1-10. The default is 0.

Dynamic Parameters	Function
ResetCmd	ResetCmd is used to issue a reset. This command returns the value in Value to 0. A reset also resets the rate and High and Low values.
Value	Calculated floating point value of the rate of change of the RefValue.
DailyHighVal	High value for the day of parameter value defined in the PntRef.
TimeOfHigh	Time that the DailyHighVal occurred.
DailyLowVal	Low value for the day of parameter value defined in the PntRef.
TimeOfLow	Time that the DailyLowVal occurred.
MonthlyHigh	High value for the month of parameter value defined in the PntRef.
TimeOfMHigh	Time that the MonthlyHigh occurred.
MonthlyLow	Low value for the month of parameter value defined in the PntRef.
TimeOfMLow	Time that the DailyLowVal occurred.
DayEnd	Time when the daily registers are reset.

Dynamic Parameters	Function
MonthEnd	Time when the monthly registers are reset.
RefValue	Floating Point value of the PntRef parameter used to determine the Value parameter.
PntStatus	Byte value indicating status of point Values are: 0: No error 15: Invalid Type for PntRef 16: Invalid Number for PntRef 17: Invalid Param for PntRef 19: PntRef point does not exist 25: PntRef is not defined
Elapse	Time of the last Change of State.
PntChecksum	CRC-16 Checksum for point's static Configuration Parameters.

Application

The AIFUNC point continually monitors the value of the PntRef reference and stores the data locally in RefValue. It then calculates a Rate of Change based upon the last 10 readings. The ScanInterval parameter determines the frequency at which readings are taken from the Pntref. The rate is calculated as a weighted sum, with the most recent readings having a higher weight.

In addition to the Rate of Change calculation, the AIFUNC point records the high and low values of the day as well as the times at which they occur. The times are reset at midnight.

Interfacing to Other Points

The AIFUNC point can be used in conjunction with almost any point that produces a floating point data value. Typical examples are the Analog Input (AI) and Tank (TANK).

The Rate of Change value can be used as input into an Analog Alarm point (AAL). This point provides a means to predict when tank fill or refill operation will be complete.

The daily high and low values are available for historical information.

Analog Status (AISTAT)



The Analog Status Point monitors a floating point value from an AI or any other point type that produces a floating point value and calculates a coded value indicating a digital status such as High, Low or Normal.

Parameters

The database parameters used by the AISTAT point are listed and described below.

Configuration Parameters	Function
Tag	A Tag can contain 15 bytes of data and can include any printable ASCII character. Tags can be used to identify points indicating the use of the point such as "High Temp Alarm" or "Hi Level Alarm." The default tag is set to "AISTAT.00".
Description	The point description can contain 30 bytes of data and can include any printable ASCII character. Descriptions can be used as information relevant to any aspect of the point, such as its use, location, operating information, etc. The default description is set to "AISTAT.00"
PntRef	Input point reference for the AISTAT point to monitor. The AISTAT point interfaces to floating point data values.

Configuration Parameters	Function
TripLow	Low Trip value. If the PntRef value is less than or equal to the TripLow value, then the Value parameter will be set to ValueLow.
TripHigh	High Trip value. If the PntRef value is greater than or equal to the TripHigh value, then the Value parameter will be set to ValueHigh.
ValueNormal	If the PntRef Value (RefValue) is between the TripLow and TripHigh parameters, then the Value parameter will be set to the ValueNormal value. The default is Normal.
ValueLow	If the PntRef Value (RefValue) is less than or equal to the TripLow parameter value, then the Value parameter will be set to the ValueLow value. The default is Low.
ValueHigh	If the PntRef Value (RefValue) is greater than or equal to the TripHigh parameter value, then the Value parameter will be set to the ValueHigh value. The default is High.
Report	Causes automatic notification to the Host (in response to a Change of State Request) when the Value Changes State. Parameter value can be High, Low or No. Report=No disables notification. Points with Report = High will be sent before points with Report = Low. The default is High.
Maxtime	Specifies the maximum time (in secs) between automatic Change of State data being sent to the Host in response to a Change of State Request. Report must be set to either Low or High for the Value parameter to be sent in response to a Change of State Request. A value of 0 disables this option. Non-zero values cause responses to be sent even if the value has not changed since the last message. The maximum is 255 seconds. The default is 60.

Dynamic Parameters	Function
Value	Represents status of the point in coded format. Typical values are Low, High or Normal. The result can be set to any valid coded data value by changing the ValueLow, ValueHigh and ValueNormal parameters.
RefValue	Floating Point value of the PntRef parameter used to determine the Value parameter
PntStatus	Byte value indicating status of point Values are: 0: No error 15: Invalid Type for PntRef 16: Invalid Number for PntRef 17: Invalid Param for PntRef 19: PntRef point does not exist 25: PntRef is not defined
Elapse	Time of the last Change of State
PntCheckSum	CRC-16 Checksum for point's static Configuration Parameters

Application

The AISTAT point continually monitors the value of the PntRef reference and stores the data locally in RefValue. It then compares RefValue to TripLow and TripHigh in order to determine whether the Value is set to Low, High or Normal. The user can override the result by changing the values of the ValueLow, ValueHigh and ValueNormal parameters.

Interfacing to Other Points

The AISTAT point can be used in conjunction with almost any point that produces a floating point data value. Typical examples are the Analog Input (AI) and TankGate points. Any of the tank gauging points can also be used. The result can be passed on to other points that require a coded data type for input.

For example, the Pump Control point can monitor a Flow Reference (FlowRef) in order to determine if there is good flow in the system. The FlowRef needs to be a coded value. If a flow switch is used, then a Digital Input (DI) point can be used directly. However, if a flow transmitter that provides a 4–20 mA signal is used, then a means is required to determine the flow status (i.e. Normal, Low or High). An AI point is used to interface to the flow signal. The user can set the TripLow and TripHigh parameters in the AISTAT point to define the flow status. The AISTAT can be used with a variety of points that require two or three states in order to function.

Alarm Selector (ALSEL)



The Alarm Selector point incorporates multiple input values to produce a single-out function. Its operation is similar to an 8-input OR gate. The ALSEL value can be used as a reference value for another point such as a digital alarm. In addition, an ALSEL value can be used as the input reference to another ALSEL.

Parameters

The database parameters used by the ALSEL point are listed and described below.

Configuration Parameters	Function
Tag	A Tag can contain 15 bytes of data and can include any printable ASCII character. Tags can be used to identify points indicating the use of the point such as “High Temp Alarm” or “Hi Level Alarm.” The default tag is set to “ALSEL.00”.
Mode	Operational mode for the ALSEL. Valid choices are Alarm, Low, LowLow, High, and HiHi.
PntRef1–16	The input point reference for the ALSEL point to monitor. The ALSEL point interfaces to coded data types.
Report	Causes automatic notification to the Host (in response to a Change of State Request) when the Value changes State. Parameter value can be High, Low or No. Report=No disables notification. Points with Report = High will be sent before points with Report = Low. The default is High.
Maxtime	Specifies the maximum time (in secs) between automatic Change of State responses being sent to the Host. Report must be set to either Low or High for the Value parameter to be sent in response to a Change of State Request. A value of 0 disables this option. Non-zero values cause responses to be sent even if the value has not changed since the last message. The maximum is 255 seconds. The default is 60.
Dynamic Parameters	Function
ResetCmd	Command to reset the alarm Value. The Value will be set to Off. This command can be used to acknowledge the alarm condition and re-arm it after the alarm condition has returned to Normal.
Value	Coded value representing the alarm condition. Value can be either Alarm or Normal.
RefValue1–16	Coded value indicating the status of the first input point reference to ALSEL point to monitor.
AlarmStatus	Indicates alarm conditions for each of the RefValue1–16 parameters. If RefValue is not Normal, its corresponding bit is set.
OutputEnable	Indicates whether the output is armed or not. When a Reset command is given, the OutputEnable bits are cleared, thus disabling the alarm.

Dynamic Parameters	Function
PntStatus	Byte value indicating status of point Values are: 0: No error 15: Invalid Type for PntRef 16: Invalid Number for PntRef 17: Invalid Param for PntRef 19: PntRef point does not exist 25: PntRef is not defined
Elapse	Time of each update.
PntChecksum	CRC-16 Checksum for point's static Configuration Parameters.

Application

The ALSEL point executes continuously, monitoring the status of the input references. This point sets the value of the function output when at least one of the input references matches the Mode. Each of the modes is explained in the table below.

Mode	Description
Alarm	Any PntRef1-16 value other than Normal will result in Value = Alarm
Low	Any PntRef1-16 value equal to Low or LowLow => Value = Alarm
LoLo	Any PntRef1-16 value equal to LowLow => Value = Alarm
High	Any PntRef1-16 value equal to Hi or HiHi => Value = Alarm
HiHi	Any PntRef1-16 value equal to High => Value = Alarm

If a PntRef is not defined, it is not used in the alarm logic.

Interfacing to Other Points

The ALSEL point is often used in conjunction with an analog alarm point (AAL) or a digital alarm point (DAL). If an alarm is generated by several sources, these sources can be used as input references into the ALSEL point. The Value parameter can then be used as the input to a DAL point. The DAL point will be activated by an alarm from any of the input sources.

Byte Register (BREG)



The Byte Register point provides a byte of storage. It is often used for inter-point communications where no other means is provided.

Parameters

The database parameters used by the BREG point are listed and described below.

Dynamic Parameters	Function
Value	Byte value

Clock (CLK)



The Clock point provides access to the System Clock. Standard time format is in the form of MM/DD/YY HH:MM:SS.

Parameters

The database parameters used by the CLK point are listed and described below.

Configuration Parameters	Function
TZ	Time Zone string
Dynamic Parameters	Function
SysTime	System Time in the form MM/DD/YY HH:MM:SS. Writing to this value will change the system time.
SysTicks	Time in "ticks" format. Ticks are incremented every 10 msec, with the initial value of 0 equal to Jan. 1, 1970 at 00:00:00
timezone	Time zone relative to GMT. The timezone is entered in seconds. Example: Eastern Time Zone = 18000; Pacific = 28800
daylight	Daylight Savings Flag

Command Activator (CMNDR)



The Command Activator point permits event based processing. The CMNDR point continually scans a reference point and based upon the value of the reference, activates a command.

Parameters

The database parameters used by the CMNDR point are listed and described below.

Configuration Parameters	Function
Tag	A Tag can contain 15 bytes of data and can include any printable ASCII character. Tags can be used to identify the name of the process being monitored. The default tag is set to "CMNDR.00".
Description	The point description can contain 30 bytes of data and can include any printable ASCII character. Descriptions can be used as information relevant to any aspect of the point, such as its use, location, operating information, etc. The default description is set to "CMNDR.00"
PntRef	Input point reference for the CMNDR point to monitor. The CMNDR point interfaces to integer and coded data values.
ControlRef	Control reference for controlling the operation of the CMNDR point. The ControlRef is be used to enable/disable the processing of the CMNDR point.
OutputLink	The output link for the OutputCmd.
Value_0 - 7	Coded value used to check for a match. The CMNDR starts comparing values from Value_0 and if a match is found, the value in the associated Command parameter is written to the OutputLink. Only the first match is executed.
Command_0 - 7	Command values for the Value_0-7 parameters in Coded format.
Output_0-7	Output values in Hexadecimal format.

Configuration Parameters	Function
Mode	Determines whether the Value or the RawValue is used. If Mode=0, the Value parameter is used and must match one of the Value0-7 values. If a match is found, then the associated Command is written to the OutputLink. If Mode=1, then the RawValue is used with the Filter. The Filter is ANDed with the RawValue and if the result is TRUE, the Command is executed. For both Mode=0 and Mode=1, only the first match is executed.
Filter	Used for Mode=1. The Filter is used in conjunction with the RawValue. The CMNDR point starts with Bit 0 and checks to see if bits are set in both the Filter and the RawValue.
Report	Causes automatic notification to the Host (in response to a Change of State Request) when the Value changes State. Parameter value can be High, Low or No. Report=No disables notification. Points with Report = High will be sent before points with Report = Low. The default is No.
Maxtime	Specifies the maximum time (in secs) between automatic Change of State responses being sent to the Host. Report must be set to either Low or High for the Value parameter to be sent in response to a Change of State Request. A value of 0 disables this option. Non-zero values cause responses to be sent even if the value has not changed since the last message. The maximum is 65535 seconds. The default is 300.

Dynamic Parameters	Function
Value	Coded value representing the state of the PntRef. Value is a coded value.
RawValue	Unsigned Integer value read from the PntRef.
OutputCmd	Output command issued to the OutputLink. The OutputCmd will be one of the values in the Command array. The OutputCmd is a coded parameter.
PntStatus	Byte value indicating status of point Values are: 0: No error 15: Invalid Type for PntRef 16: Invalid Number for PntRef 17: Invalid Param for PntRef 19: PntRef point does not exist 25: PntRef is not defined
Control	Used to Enable or Disable the processing of the CMNDR point. The ControlRef may be used to automate the Control parameter.
Elapse	Time of execution
PntChecksum	CRC-16 Checksum for point's static Configuration Parameters

Application

The CMNDR point operates by scanning a point reference defined by the PntRef. Depending upon the Mode, the data is stored locally in either the Value or RawValue parameter. If Mode = 0, the Value parameter is used. The CMNDR searches the Value array and when a match is found, the corresponding Command is written to the OutputLink. If no match is found, no action is taken.

If Mode = 1, the RawValue is used. The CMNDR performs a bit comparison of the RawValue with the Filter. When the logical AND of the RawValue and Filter is found, the corresponding Command is written to the OutputLink.

The Control parameter can be used to disable processing. When the Control parameter is set to Enable, or Undefined, processing is enabled. If Control is Disable, no processing is done. The ControlRef parameter may be used to automatically update the Control parameter based upon another point reference.

Interfacing to Other Points

The CMNDR point can be used in conjunction with almost any point that produces an integer or coded data value. An example is the Digital Input (DI) points. The typical OutputLink is a Digital Output (DO) point, although it could be any coded parameter in the database. The ControlRef can be any type of point that produces a parameter value of Enable and Disable. Typical examples are Digital Input (DI) and Digital Converter (DICONV) points. The CMNDR point is not limited to these types of points and can be used to solve a variety of problems.

Communications (COM)



The Communications point reports the status and controls the operation of the communications interfaces. COM points are automatically created by the system at initialization.

Parameters

The database parameters used by the COM point are listed and described below.

Configuration Parameters	Function
Protocol	Protocol handler assigned to the ComPort. Valid values are: Disabled 8130 RTU Slave 8130 RTU Master Modbus Slave Modbus Master HART Master Enraf Master CIU TSU Slave Local Diag Printer RTU Slave RTU Master Enraf Master HART Master MODBUS Master MODBUS Slave Local Diag Disabled Generic Gauge VR Master The defaults are: COM 0: 8130 RTU Slave – 9600 Baud COM 1: 8130 RTU Slave – 19200 Baud COM 2: 8130 RTU Slave – 19200 Baud COM 3: 8130 RTU Master
Mode	The Mode parameter is used in conjunction with the Protocol. Different protocols will use the Mode in different ways, depending on the needs of the protocol.
ComPort	Communications Port number. Valid values are 0–3. The ComPort parameter should never be modified by the user.

Configuration Parameters	Function
BaudRate	Baud Rate for communications to either the Host or Slave system. Valid values are: 1200, 2400, 4800, 9600, 19200, 24000. Changing the BaudRate parameter will immediately change the configuration of the ComPort. The default value is 9600.
ComParams	Defines the number of data bits and the parity used by the . . Examples include: 8O – 8 Data Bits Odd Parity 8E – 8 Data Bits, Even Parity 8N – 8 Data Bits, No Parity 7O – 7 Data Bits, Odd Parity 7E – 7 Data Bits, Even Parity 7N – 7 Data Bits, No Parity TI – TIWAY The default is '8N'.
TimeOut	Time in seconds that indicates a time-out of communications. If no Host or Slave communications is received for the length of time specified by the TimeOut, the CommStatus parameter will indicate Off Line and communications failure processing will take place.
ErrCheck	Error checking used by the protocol. Valid values are: LRC – Longitudinal Redundancy Check CRC – Cyclical Redundancy Check
RespDelay	Time in milliseconds that 8130 RTU will delay a response to the Host. The default is 50 msec.
SynchMax	The SynchMax is used by some slave protocols for auto-synchronization of the BaudRate. The SynchMax is used to determine if the BaudRate is correct. If the SynchMax is zero, then no synchronization is attempted. The default is 50 msec.
DirectPort	The DirectPort is used then the Protocol is set to Direct.
Dynamic Parameters	Function
CommStatus	Coded variable indicating the On-line/Offline status of the COM point.
State	Current state of the message being sent/received.
Command	Current command being processed.
Status	Status if the last message.
CommErrors	The number of communication errors.
NumTrans	The number of transactions.
Elapse	Time of the last Change of State.
PntChecksum	CRC-16 Checksum of point's static Configuration Parameters.

Application

The COM point controls the operation of Host and Slave communications. The Baud Rate, Communications Parameters and Protocol may be changed by assigning values to the appropriate parameter. Each Com port is independent of the other and completely flexible in its use.

For example, the user may configure the system to communicate with a single host redundantly using the same protocol. Alternatively, the 8130 can communicate to different hosts using different protocols, allowing the 8130 RTU to act as a bridge. Other options include assigning one COM point to communicate with a Slave device while communicating to a Host system on the other.

Interfacing to Other Points

The COM point can be used in conjunction with a Communications Watchdog Point (WDOG) to provide for shutdown of the Digital and Analog Outputs when a communications failure occurs.

Coded Register (CREG)



The Coded Register point provides two bytes of storage in the 8130 RTU Coded format. It is often used for inter-point communications where no other means is provided.

Parameters

The database parameters used by the CREG point are listed and described below.

Dynamic Parameters	Function
Value	Coded Value Format (2 bytes)

Digital Alarm (DAL)



The Digital Alarm Point monitors a coded value from a DI, ALSEL or other point and activates an output if an alarm condition is detected.

Parameters

The database parameters used by the DAL point are listed and described below.

Configuration Parameters	Function
Tag	A Tag can contain 15 bytes of data and can include any printable ASCII character. Tags can be used to identify points indicating the use of the point such as "High Temp Alarm" or "Hi Level Alarm." The default tag is set to "DAL.00".
Description	The point description can contain 30 bytes of data and can include any printable ASCII character. Descriptions can be used as information relevant to any aspect of the point, such as its use, location, operating information, etc. The default description is set to "DAL.00"
PntRef	Input point reference for the DAL point to monitor. The DAL point interfaces to coded data values.
ControlRef	Control reference for controlling the operation of the DAL point. The ControlRef is be used to enable/disable the output point link of the DAL point.
OutputLink	Output point Link for the DAL point to control. The DAL point outputs an ON or OFF value.
Mode	The Mode parameter determines whether the Value or the RawValue is used. 0 - Use the Value parameter 1 - Use the RawValue and the Filter
Filter	If the Mode is 1, then the RawValue and Filter are used. The logical AND operation of the RawValue and the Filter will cause an alarm condition.
Report	Causes automatic notification to the Host (in response to a Change of State Request) when the Value Changes State. Parameter value can be High, Low or No. Report=No disables notification. Points with Report = High will be sent before points with Report = Low. The default is High.

Configuration Parameters	Function
Maxtime	Specifies the maximum time (in secs) between automatic Change of State data being sent to the Host in response to a Change of State Request. Report must be set to either Low or High for the Value parameter to be sent in response to a Change of State Request. A value of 0 disables this option. Non-zero values cause responses to be sent even if the value has not changed since the last message. The maximum is 255 seconds. The default is 60.
Dynamic Parameters	Function
ResetCmd	A Reset command will deactivate the output. Any change in the Value will retrigger alarm processing.
Value	Coded value representing the alarm condition. Value can be either Alarm or Normal. The Value is derived from the PntRef.
RawValue	The RawValue is the value read from the PntRef. If bits are set in both the RawValue and the Filter, an alarm condition is detected.
OutputCmd	Current command sent to the OutputLink point
Control	This parameter is used to enable/disable the ControlRef ability to control the DAL output value
Elapse	Time of the last Change of State
PntChecksum	CRC-16 Checksum for point's static Configuration Parameters
PntStatus	Byte value indicating status of point Values are: 0: No error 15: Invalid Type for PntRef 16: Invalid Number for PntRef 17: Invalid Param for PntRef 19: PntRef point does not exist 25: PntRef is not defined

Application

The DAL point continually monitors the value of the PntRef reference and stores it locally in either the Value or RawValue parameters. For Mode = 0, it stores it in the Value parameter. If the Mode = 1, the PntRef data is stored in the RawValue.

If Mode = 0, and the Value is NORMAL or OFF, then the command to the OutputLink is OFF. If the value of the PntRef is ALARM or ON, then the command to the OutputLink is ON. Any other PntRef values are ignored. For Mode = 1, the logical AND operation of the RawValue and the Filter will result in an alarm.

Interfacing to Other Points

The DAL point can be used in conjunction with almost any point that produces a coded data value. Typical examples are the Digital Input (DI) and Analog Status (AISTAT) points. Refer to the following example.

The typical OutputLink is a Digital Output (DO) point; however, the DAL point is not limited to these types of points and can be used to solve a variety of problems.

Digital Input (DI)



The Digital Input Point interfaces to discrete input signals such as contact closures and proximity switches. The DI point can convert raw data into a usable format such as ON/OFF, OPENED/CLOSED, HIGH/LOW or HAND/OFF/AUTO. The DI point can also latch momentary status changes or perform debounce filtering.

The DI point is typically used when a Model 8201 16 Channel Digital I/O Module or a Model 8204 8 Channel Multi-Function Module is present.

Parameters

The database parameters used by the DI point are listed and described below:

Configuration Parameters	Function
Tag	A Tag can contain 15 bytes of data and can include any printable ASCII character. Tags can be used to identify points indicating the use of the point such as "High Temp Alarm" or "Hi Level Alarm." The default tag is set to "DI.00".
Description	The point description can contain 30 bytes of data and can include any printable ASCII character. Descriptions can be used as information relevant to any aspect of the point, such as its use, location, operating information, etc. The default description is set to "DI.00"
Channel	Physical Channel (1–32). A value of 0 disables data scanning for the channel. For multi-channel devices, this is the first channel of the channel sequence. The default is to match the Point Name, i.e., DI.00 = Channel 1.
ChanQuan	Total number of physical channels assigned to the point (0–16). The default is 1.
Value_0	Allows for conversion of the RawValue parameter to a coded symbol value such as Off or Normal. Value_0 corresponds to the desired Value when RawValue=0. The user may choose from any predefined coded value. The default is Off.
Value_1	Allows for conversion of the RawValue parameter to a coded symbol value such as On or Alarm. Value_1 corresponds to the desired Value when RawValue=1. The user may choose from any predefined coded value. The default is On.
Value_2	Similar to Value_0 and Value_1. Value_2 corresponds to the desired Value when RawValue=2. In this case, the ChanQuan parameter must be set to 2 in order to define 4 states. An example would be a Valve with two limit switches where the states would be Trans, Opened, Closed and Invalid. The default is Undefined.
Value_3	Similar to Value_0 & Value_1. Value_3 corresponds to the desired Value when RawValue=3. In this case, the ChanQuan parameter must be set to 2 in order to define 4 states. The default is Undefined.
Reverse	Causes the sensing inputs to change from Normally-Open to Normally-Closed. When set to Yes, the inputs are treated as Normally-Closed contacts. When set to No, the inputs are treated as Normally-Open contacts. Default is No.
Latch	Causes the input to be treated as a latching contact. When set to Yes, momentary digital inputs are latched. Each time a contact closure (or opening if Reverse = Yes) is sensed, Value will toggle. Default is No.
Filter	Specifies the number of consecutive identical samples received before the Value is allowed to change. The Filter parameter allows for contact debounce and can be used to prevent a spurious reading from causing a Change Of State. The default is 2.
Report	Causes automatic notification to the Host (in response to a Change of State Request) when the Value changes State. Parameter value can be High, Low or No. Report=No disables notification. Points with Report = High will be sent before points with Report = Low. The default is High.
Maxtime	Specifies the maximum time (in secs) between automatic Change of State responses being sent to the Host. Report must be set to either Low or High for the Value parameter to be sent in response to a Change of State Request. A value of 0 disables this option. Non-zero values cause responses to be sent even if the value has not changed since the last message. The maximum is 255 seconds. The default is 60.

Dynamic Parameters	Function
Value	Coded string representing the current converted RawValue of the channel(s) assigned to the point. Other points use Value as input for higher level processing.
RawValue	Binary number representing the current value of the channel(s) assigned to the point. The Raw Value is calculated using the Filter parameter. Some points use the RawValue instead of the Value parameter.
PntStatus	Byte value indicating status of point Values are: 0: No error 3: Configuration change 4: Configuration checksum error 6: Value changed but did not pass Filter criteria
Elapse	Time of the last Change of State
PntChecksum	CRC-16 Checksum for point's static Configuration Parameters

Application

The DI point executes once every 250 milliseconds and converts Digital Scanner data to coded value data (ON/OFF, etc.). The Digital Scanner runs every 20 msec and reads the status of the digital I/O modules. The Digital Scanner data is stored in an array which is then analyzed periodically by the DI point. The following graph shows the relationship between the Digital Scanner and the DI point:

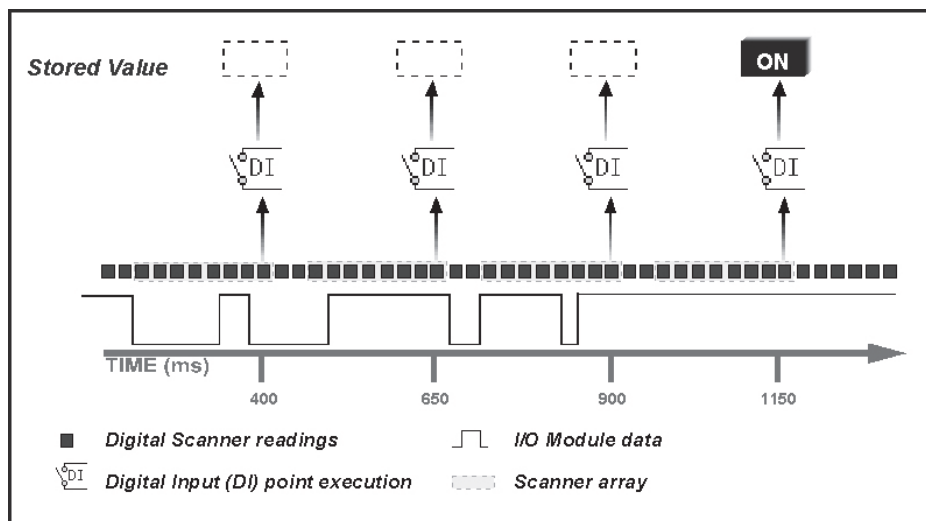

Figure 6-4: Application of the DI point

The Filter is applied to the Digital Scanner data array. For example, if the Filter is set to 3, then 3 successive readings must be the same in order for a Change of State to occur. The following graph shows the use of the Filter parameter:

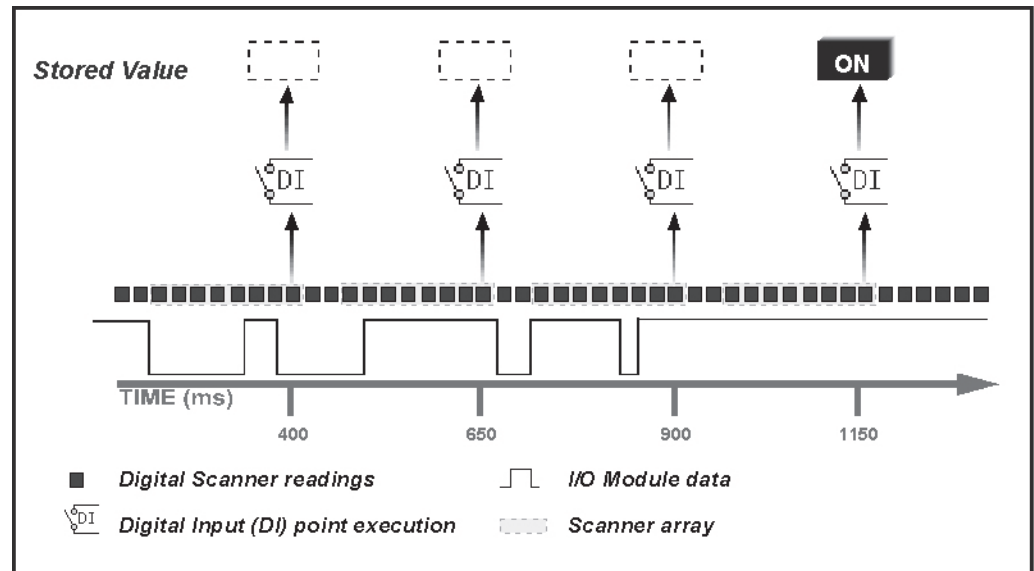

Figure 6-5: DI Point: Change of State diagram

Reading an Entire I/O Module

An entire I/O module can be read by a single point by setting the ChanQuan parameter to 16. In this case the Value parameter will be Undefined and the RawValue parameter will represent the hexadecimal value of the I/O data. Note that the status of a Digital Output (DO) point can be read as a Digital Input.

Mapping Multiple Points

It is sometimes useful to map multiple DI points to a single channel. For example, one DI point may be used to read the status of a pump and convert the data to ON/OFF using the Value_0 and Value_1 parameters. This data would then be made available to a PUMP point.

A second DI point can be assigned to read the same channel and convert the data to ENABLE/DISABLE by changing the Value_0 and Value_1 parameters. This data can then be used as a control parameter for a totalizer, allowing totalization to take place only when the pump is running.

Interfacing to Other Points

The DI is often used as the input source (a Reference) for other point application programs. The Digital Alarm (DAL), Hand/Off/Auto (HOA), Pump Control (PUMP) and Valve Control (VALVE) points use DI point data to calculate other data values or effect control. The Value and the RawValue are the parameters calculated by the DI point and can be used as input in other points.

In some cases it might be necessary to re-define the Value_0 - Value_3 parameters as required by the other application point. For example, the DAL point looks for a NORMAL/ALARM condition and controls a Digital Output point accordingly.

Diagnostic (DIAG)



The Diagnostic point monitors built-in onboard functions such as the Unit Temperature, the Unit Current, Field Power and the Intrusion alarm. The DIAG point also provides the parameters list for the Front Panel Display when COM 0 is configured as the Local Diagnostic port.

Parameters

The database parameters used by the DIAG point are listed and described below.

Configuration Parameters	Function
Mode	Determines how the Local Diagnostic Interface will operate. Values are 1. Normal Mode (Full Access) 2. Update Mode 3. Tank Mode
LevelUnits	Units used on Local Display Unit. E=Englist (ft-in-16ths), M=Metric. The default value is E.
PntRef1 PntRef8	Point References to database parameters that are displayed in update mode when the Local Diagnostic Display is connected to a COM port. Up to 8 references may be used. Refer to Chapter 6 for more information on the Local Diagnostic mode
UpdateRate	The UpdateRate parameter is used in conjunction with the PntRef1 – PntRef8 parameters in the Local Diagnostic mode. The default value is 10 seconds.
Dynamic Parameters	Function
Command	Diagnostic command to issue to the 8130 RTU.
Value_0 to Value_3	Command data used with the Command parameter.
UnitTemp	Floating point value of the built-in temperature monitor presented in degrees F.
UnitCurrent	Floating point value of the built-in current monitor presented in mA.
FieldCurrent	Floating point value of the built-in current monitor presented in mA
InputPower	Indicates whether the 8130 RTU is operating from AC or DC power.
Intrusion	Coded data value of the state of the built-in intrusion alarm (either Normal or Alarm).
Elapse	Time of the last Change of State

Application

The Diagnostic point periodically scans the 8-bit A/D converter on the 8130 RTU motherboard and converts the data into floating point values. It also scans the state of the Intrusion Alarm.

The values calculated include the Unit Temperature, and both the Unit and Field Currents (of the 24VDC supply). The range on the Unit Temperature is -13°F to 212°F. The range on the Unit and Field Currents is 0 to 1100 mA. The Unit Current will include the values of the Field Current and the current required to operate the motherboard and I/O module circuitry.

The DIAG point also allows the user to specify up to 8 parameters that will be displayed on the Front Panel Display when one of the COM ports is configured in the Local Diag mode. Typically, COM 0 is used for this purpose. Refer to Chapter 8 Local Diagnostics Interface for more information on this mode of operation.

Digital Output (DO)



The Digital Output Point interfaces to digital output signals such as pumps, valves, annunciators, or any other type of actuators. The DO point is used to provide access to the output registers of a Model 8201 16 Channel Digital I/O Module or a Model 8204 Multi-Function Module.

Parameters

The database parameters used by the DO point are listed and described below:

Configuration Parameters	Function
Tag	A Tag can contain 15 bytes of data and can include any printable ASCII character. Tags can be used to identify points indicating the use of the point such as "High Temp Alarm" or "Hi Level Alarm." The default tag is set to "DO.00".
Description	The point description can contain 30 bytes of data and can include any printable ASCII character. Descriptions can be used as information relevant to any aspect of the point, such as its use, location, operating information, etc. The default description is set to "DO.00"
Channel	Physical Channel (1-32). For multi-channel devices, this is the first channel of the channel sequence. The default is to match the Point Name, i.e., DO.00 = Channel 1.
ChanQuan	Total number of physical channels assigned to the point (0-8).
Value_0	Value_0 corresponds to the command to de-activate an output The user may choose from any predefined coded value. The default is Off.
Value_1	Value_1 corresponds to the command to activate an output The user may choose from any predefined coded value. The default is On.
ContactType	Determines how the output valve should be set (opened or closed). The default value is NO (Normally Open).
Pulse	Time in tenths of a second that output will remain active, after which it de-activates. A value of 0 disables pulsing the output, i.e., the output remains active until Value is changed. The default is set to 0.
CommFailValue	Determines the state of the Value parameter. Is used in case of a communication failure. A Communications Watchdog point (WDOG) must be configured to activate this feature.
Report	Causes automatic notification to the Host (in response to a Change of State Request) when the Value changes State. Parameter value can be High, Low or No. Report=No disables notification. Points with Report = High will be sent before points with Report = Low. The default is No.
Maxtime	Specifies the maximum time (in secs) between automatic Change of State data being sent to the Host in response to a Change of State Request. Report must be set to either Low or High for the Value parameter to be sent in response to a Change of State Request. A value of 0 disables this option. Non-zero values cause responses to be sent even if the value has not changed since the last message. The maximum is 255 seconds. The default is 0.
Dynamic Parameters	Function
Value	Coded value representing the output value of the channels assigned to the point
RawValue	Binary number that represents the current value of the channel(s) assigned to the point.
PntStatus	Byte value indicating status of point Values are: 0: No error 3: Configuration change 4: Configuration checksum error
Elapse	Time of the last Change of State
PntChecksum	CRC-16 Checksum for point's static Configuration Parameters

Application

The DO point provides an interface to the Model 8201 16 Channel Digital Input/Output Module and the Model 8204 8 Channel Multi-Function Module. The DO point executes by exception. In this mode, an output is driven whenever another point or when the user issues a command.

In some cases, the user may want the output to de-activate if the 8130 RTU goes offline. The Communications Watchdog point (WDOG) can be configured to notify DO points to revert to a default value when the 8130 RTU goes offline. The CommFailValue sets the value to set the Value parameter to when the 8130 RTU goes offline. This feature is activated by the WDOG point. If no WDOG point exists, then the output will not be changed by an offline condition (the default mode).

Interfacing to Other Points

The DO point is often used as the destination (a Link) for other point application programs. The Pump Control (PUMP), Valve Control (VALVE) and Digital Alarm (DAL) points are examples of points that send commands to the DO point.

Double Word Register (DREG)



The Double Word Register point provides four bytes of storage. It is often used for inter-point communications where no other means is provided.

Parameters

The database parameters used by the DREG point are listed and described below.

Dynamic Parameters	Function
Value	Double Word (4 bytes) value

Emulator (EMU)



The Emulator point allows the to emulate a Whessoe-Varec Model 6820 Tank Scanning Unit (TSU). This point provides access for level, temperature data, and gauge status information from any type of tank gauge interface supported by the 8203 Dual RS-485 Communications Interface Module.

Parameters

The database parameters used by the EMU point are listed and described below:

Configuration Parameters	Function
Tag	The point description can contain 30 bytes of data and can include any printable ASCII character. Descriptions can be used as information relevant to any aspect of the point, such as its use, location, operating information, etc. The default description is set to "EMU.00".
LevelUnits	Specifies the engineering units for the level data. F: feet, m: Millimeters M: Meters I: Inches P: ft-in-16ths The LevelUnits need to match the units specified during the gauge setup.

Configuration Parameters	Function
TempUnits	Specifies the engineering units for the temperature data. TempUnitsSpecifies the engineering units for the temperature data. F: Fahrenheit C: Celsius The TempUnits needs to match the units specified during the gauge setup.
DensityUnits	Specifies the engineering units for the density data. DensityUnitsSpecifies the engineering units for the density data. K: kg/m ³ A: API L=lbs/cu ft The DensityUnits needs to match the units specified during the gauge setup.
Offset	Specifies the offset to the first address.
PntRef1 – 20	Input point reference for the EMU point to monitor. The PntRef parameter is set to the Level parameter for the tank gauge point. The temperature will be read at the same time as the level. The EMU point interfaces tank gauge interface points: WV1900 – Whessoe–Varec Model 1900
Dynamic Parameters	Function
PntStatus	Byte value indicating status of point Values are: Dynamic ParametersFunction PntStatusByte value indicating status of point Values are: 0: No error 15: Invalid Type for PntRef 16: Invalid Number for PntRef 17: Invalid Param for PntRef 19: PntRef point does not exist 25: PntRef is not defined
PntChecksum	CRC–16 Checksum for point's static Configuration parameters.

Application

The Emulator point (EMU) provides a communication interface between older tank gauging system and point blocks within the 8203 Dual RS–485 Communications Interface Module . Currently, the 8203 Dual RS–485 Communications Interface Module can emulate a Whessoe Varec Model 6810 Tank Scanning Unit (TSU).

The EMU point associates a tank gauge point with an address to be used by TankView. EMU.0 provides point references for TankView System Addresses 1–50. EMU.1 is associated with System Addresses 51–100. A EMU Gateway (EMUGW) point is automatically created when the protocol for a COM point is set to TSU Slave.

EMU Gateway (EMUGW)



The EMU Gateway point is used to manage scanning functions for the EMU point. Statistics are maintained for the communications between the Series 8130 and the tank gauging software (TankView or System IV). Special firmware is required on the 8203 Dual RS–485 Communications Interface Module to support the emulation functions.

Parameters

The database parameters used by the EMUGW point are listed and described below:

Configuration Parameters	Function
Protocol	Protocol to emulate. Valid values are: TSU Slave
ID	Address to respond to
Mode	Operational Mode
BaudRate	Baud Rate used to communicate with TankView. The default is 1200.
ComParams	Defines the number of data bits and the parity used by the com port. Examples include: ID: Address to respond to Mode: Operational Mode BaudRate: Baud Rate used to communicate with TankView ComParams Defines the number of data bits and the parity used by the com port. Examples include: 8O – 8 Data Bits Odd Parity 8E – 8 Data Bits, Even Parity 8N – 8 Data Bits, No Parity 7O – 7 Data Bits, Odd Parity 7E – 7 Data Bits, Even Parity 7N – 7 Data Bits, No Parity The default is '7E' or 7 data bits, even parity.
LevelConvert	Determines the units in which the level data will be displayed. F: feet, M: Millimeters. If no value is specified, no conversion will be performed.
TempConvert	Determines the units in which the temperature data will be displayed. F: Fahrenheit, C: Celsius. If no value is specified, no conversion will be performed.
DensityConvert	Determines the units in which the density data will be displayed. A: API, L: lbs/cu ft, K: kgs/m ³ . If no value is specified, no conversion will be performed.
Dynamic Parameters	Function
Message	Hex representation of the request sent by the host
Command	Current Command
Addr	Displays the tank number of the currently selected tank.
LevelRef	The reference point for level and temperature data for the tank currently requested by TankView
Flags	Hex value representing the operational status
NumRequests	Number of requests from TankView or Entis
NumComErrors	Number of errors
Elaspe	Time of last request
PntChecksum	CRC-16 Checksum for point's static Configuration Parameters.

Application

The EMUGW point is automatically created when the TankView (TSU Slave) protocol is initiated. In order to use the TSU Slave protocol, set the Protocol parameter of the COM point to TSU Slave. At that time, an EMUGW and an EMU point will be created to provide a user interface for

configuration and control of communications with TankView or System IV. The baud rate and data link parameters are set in the COM point as well. The default is 9600, 8 data bits, No parity.

The EMUGW point keeps track of the number of requests and number of errors associated with the EMU Slave protocol. The current tank number (ID) and the point associated with the tank number (LevelRef) are updated as requests from TankView are processed. The PntRefs correlate to the SYS ADR parameter in TankView or IDs in System IV.

Floating Point Register (FPREG)



The Floating Register point provides four bytes of storage in IEEE floating point format. It is often used for inter-point communications where no other means is provided.

Parameters

The database parameters used by the FPREG point are listed and described below.

Dynamic Parameters	Function
Value	Real (4 bytes) value

Gateway Block (GWBLK)



The Gateway Block point is used for compatibility with Modbus Master devices. The 8130/8130 RTU has no fixed Modbus register map. Rather, the user configures a GWBLK to function as a look-up table. The GWBLK point lets the user specify which point references will respond to data addresses in the request from a Host. The GWBLK point contains a cross-reference table for database parameters and data addresses.

Parameters

The database parameters used by the GWBLK point are listed and described below.

Configuration Parameters	Function
Tag	A Tag can contain 15 bytes of data and can include any printable ASCII character. Tags can be used to identify points indicating the use of the point such as "Modbus Slave" or "Register Value1." The default tag is set to "GWBLK.00"
Protocol	Protocol that the GWBLK point is used with. Valid values are Modbus Slave. If not set, the 8130 RTU assumes the protocol is Modbus.
ComPort	Bit mask to enable address referencing. If a bit corresponding to the . , then address referencing is enabled for the channel. The default is 0xFF (all COM ports)
DataMode	Integer HEX value that controls the data returned to a Modbus Host 0: Use parameter values 0x01: Convert to Integer 0x02: Return 0xFF if the data is invalid. 0x04: Convert to Integer using only the Scale If the DataMode is 0x01, the PntRef data will be converted to an integer using the Offset, Scale, ValueMin and ValueMax. If the DataMode is 0x04, the Scale parameter is used to convert to an integer. It is possible to set multiple bits.
RegSet	Register set size.

Configuration Parameters	Function
Offset	Input range Offset used for scaling the output to an integer value when DataMode=0.
Scale	Input range Scale used for scaling the output to an integer value. When DataMode=0.
ValueMin	Output range Offset used for scaling the output to an integer value when DataMode=0.
ValueMax	Output range Scale used for scaling the output to an integer value when DataMode=0.
CommFailValue	Value to set all of the output registers to when there is a communications or other failure. The CommFailValue works in conjunction with the Filter values. If the PntStatus of the PntRef has bits set that match the Filter, the reference value is declared invalid and the output value will be set to the CommFailValue. This mode is overridden by DataMode = 0x02.
Addr1 PntRef1 Size1 Filter1 Addr10 PntRef10 Size10 Filter10	Addr1 is the Data Address and PntRef1 is the corresponding database parameter that will be used for a response. The default Size is 1. See the discussion below for more detail on the Size parameter. The Filter is used to determine if the data is valid. The PntStatus of the point specified by the PntRef is read and if there are bits set that match the Filter, the source data is considered invalid. The output registers will be set to the value determined by the CommFailValue.
Dynamic Parameters	Function
PntStatus	Byte value indicating status of point Value: 0: No error
PntChecksum	CRC-16 Checksum of point's static Configuration Parameters

Application

The GWBLK point is a look-up table used by the Modbus Slave protocol handler. Up to sixteen address-point reference pairs may be used per GWBLK point. Multiple GWBLK points may be used if necessary. The Addr parameter specifies the data address. The corresponding PntRef parameter specifies the database parameter for the request. The Gateway Block point allows the user to use the 8130 RTU easily in retro-fit applications. It is not necessary to re-configure an existing MMI or Host system. The user can configure the 8130 RTU to match the addresses used in the Host system.

When the Modbus Slave protocol handler receives a request, it searches the GWBLK points to determine if any of the Addr parameters match the request. If a match is found, the data referenced by the PntRef parameter will be used for the response.

There are three data modes: DataMode=0, which returns the data in the default format, and DataMode=1, which returns the data in an integer format. DataMode=1 will scale IEEE floating point data to an integer value, using the Offset, Scale, ValueMin and ValueMax parameters. If DataMode = 4, the data will be scaled to an integer by multiplying the data value times the Scale parameter.

The DataMode can also control if the data is changed to 0xFF if the data is invalid. The Filter parameter is compared to the PntStatus of the PntRef parameter. If bits in the PntStatus match bits in the Filter, the data is considered invalid and the a read from a modbus host will result in the data being set to 0xFF.

When Block Read or Write requests are received, then the way in which the Modbus Slave protocol handler responds is determined by the Size parameter.

Size Parameter

A range of addresses can be specified by setting the Size parameter. This sets the indexing mode to Number Indexing, which means that Block Read/Write requests from the Hosts are handled by stepping through the points number by number. For example, if Addr1 is 100, and PntRef1 is DI.00.RawValue, then a Block Read to address 100 with a length of 8 will return the values, DI.00.RawValue, DI.01.RawValue, .. DI.07.RawValue.

I/O Configuration (IO)



The I/O Configuration point provides information about the I/O configuration of the 8130 RTU. The IO point also allows the user to issue reset commands to certain modules.

Parameters

The database parameters used by the IO point are listed and described below.

Configuration Parameters	Function
ChanMode	The ChanMode parameter determines whether AI, DI, AO and DO points are addressed starting at 0 or 1. The default is 1, i.e., all physical channels are addressed starting with 1.
IOPort1 – IOPort4	I/O Module connected to the I/O expansion ports P1 – P4. At initialization, the 8130 RTU will interrogate each port to determine which I/O Modules are present. If 0, then no device was found. Valid values include the following: 8201 – 16 Channel Digital In-/Out 8203 – Dual RS-485 Communication Interface 8204 – 8-Channel Multi-Function 8205 – 16-Channel Analog Input 8207 – 8-Channel Analog Output 8208 – TIWAY Interface 8210 – Varec Mark/Space Interface 8211 – Current Loop Interface 8212 – Saab Interface 8213 – V1 Interface (Varec) 8214 – Enraf Interface 8215 – L&J Tankway Interface 8216 – LON Interface (Barton Instruments) 8217 – Dual RS-232 Interface
Dynamic Parameters	Function
IOStatus1 – IOStatus4	Status word for each port. The bits are defined as follows: 0x0200 – High Queue Change of State 0x0100 – Low Queue Change of State 0x0080 – Dynamic Change of State 0x0040 – Config Change of State 0x0008 – Module startup error 0x0004 – Module database is empty 0x0002 – Module configuration has changed 0x0001 – Module is no longer responding
IOCommand1 – IOCommand4	Command to Reset a particular module.
PntStatus	Byte value indicating status of point.

Dynamic Parameters	Function
PntChecksum	CRC-16 Checksum for point's static Configuration Parameters

Application

The IO point provides status and configuration information for I/O modules used with the 8130 RTU. The IO point is created automatically at startup. The IO point then interrogates each port to determine modules are present. In many cases, the presence of a module will also cause the automatic creation of scanner points.

Integer Register (IREG)



The Integer Register point provides two bytes of storage. It is often used for inter-point communications where no other means is provided.

Parameters

The database parameters used by the IREG point are listed and described below.

Dynamic Parameters	Functions
Value	Integer (2 bytes) value

Modbus Gateway (MODGW)



The Modbus Gateway provides dynamic and statistical information for the communications between the 8130 RTU and the Modbus masters.

Parameters

The database parameters used by the MODGW point are listed and described below.

Configuration Parameters	Function
ID	Slave Address that the Modbus Slave protocol handler will respond to. The default is to match the Unit Address of the 8130 RTU.
Mode	Operational Mode. The Mode is a hex value, with individual bits controlling various aspects of the operation of the Modbus Slave protocol handler. The bits have the following meanings: 0x01 - Set Param Indexing mode 0x02 - Integer Swap mode 0x04 - Swap CRC bytes 0x20 - Wonderware Mode 0x80 - Ignore any trailing nulls in the request The default is 0.
BaudRate	Baud Rate for communications to the Host system. Valid values are: 1200, 2400, 4800, 9600 and 19200. Changing the BaudRate parameter will immediately change the configuration of the ComPort. The default is 19200.

Configuration Parameters	Function
ComParams	Defines the number of data bits and the parity used by the . . Valid values include: 8N – 8 data bits, No parity 8O – 8 data bits, Odd parity 8E – 8 data bits, Even parity 7O – 7 data bits, Odd parity 7E – 7 data bits, Even parity The default is '8N'.
DetectTime	Modbus 8130 RTU Mode character timer (in 1/100s of a second). The default value is 100.
Dynamic Parameters	Function
Message	Current request message, displayed in hex format
Command	Current command. Values include: 1 – Read Output Status 2 – Read Input Status 3 – Read Output Registers 4 – Read Input Registers 5 – Force Single Coil 6 – Preset Single Register 15 – Force Multiple Coils 16 – Preset Multiple Registers
Addr	Data Address for current request.
Elapse	Time of the last request from the master.
PntChecksum	CRC-16 Checksum of point's static Configuration Parameters.

Application

The MODGW point provides status information for the communications with any Modbus masters used with the 8130 RTU. On the 8130 RTU Motherboard, the MODGW point is created automatically whenever the Modbus Slave protocol is defined for a COM point. The point number created will correspond to the ComPort such that MODGW.09 is created for COM 0, MODGW.10 is created for COM 1 and MODGW.11 is created for COM 2. Use the Upload command from the Config Menu to retrieve the data from the MODGW point or any other points created automatically by the 8130 RTU.

The MODGW point provides information about the current command and data address requested by the Modbus master system. The MODGW provides assurance that requests are being received and processed.

Modbus I/O (MFIO)



The Modbus I/O Module point is used for communicating with Allen Bradley Flex I/O Modules. The MFIO point lets the user specify what Modbus data is read from the Allen Bradley Module and it also allows data configuration. The MFIO point executes on either the 8130 RTU Motherboard or on the 8203 Dual RS-485 Interface module (MODx_xx firmware).

Parameters

The database parameters used by the MFIO point are listed and described below.

Configuration Parameters	Function
Tag	A Tag can contain 15 bytes of data and can include any printable ASCII character. Tags can be used to identify points indicating the use of the point such as "Modbus Slave" or "Register Value1." The default tag is set to "MFIO.00"
Module	Physical address (1–4) of the Model 8203 used to interface to the slave device. A value of 0 will use the 8130 RTU Motherboard. A value of 255 is undefined.
Chan	Physical channel number the Allen Bradley is connected to. On the Model 8203 the Chan can be set to 1 or 2. On the 8130 RTU Motherboard, the Chan can be set to 0, 1 or 2. The default value is 0.
BaudRate	Baud Rate for communications to the Slave device. Valid values are: 1200, 2400, 4800, 9600 and 19200 . The default is 19200.
ComParams	Defines the number of data bits and the parity used by the . . Valid values include: 8N – 8 data bits, No parity 8O – 8 data bits, Odd parity 8E – 8 data bits, Even parity 7O – 7 data bits, Odd parity 7E – 7 data bits, Even parity The default is 8N.
ID	Physical Address of the Allen Bradley Module.
ReadCmd	Command used to Read data from the Allen Bradley. Usually 3 or 4. Default is 3.
WriteCmd	Command used to Write data to the Allen Bradley. Usually 5 or 6. Default is 6.
Addr1 Size1	Data Address and Size. This is the register data read from the Allen Bradley Module. Addr1 is the register start address. The Size1 parameter determines how many values are read. Default is 8. The values can be seen in the Value1–8 parameters. Consult the Allen Bradley documentation for more information.
Addr2 Value_2 Addr3 Value_3 Addr4 Value_4	These parameters are used to send data to the Configuration Registers of the Allen Bradley Module. They are written to the Allen Bradley as soon as communication is established. AddrX determines the Address of the point, while Value_X is the actual data written to AddrX. For more information on the configuration registers, consult the Allen Bradley documentation.
Offset	Input range offset used for scaling the input values.
Scale	Input range scale used for scaling the input values.
ValueMin	Output range offset used for scaling the output values.
ValueMax	Output range scale used for scaling the output values.
Report	Causes automatic notification to the Host (in response to a Change of State Request) when a value changes. Parameter value can be High, Low or No. Report = No disables automatic notification. Points with Report = High will be sent before points with Report = Low. The default is No.
Maxtime	Specifies the maximum time (in secs) between automatic Change of State responses being sent to the Host. Report must be set to either Low or High for the Value parameter to be sent in response to a Change of State Request. A value of 0 disables this option. Non-zero values cause responses to be sent even if the value has not changed since the last message. The maximum is 65535 seconds. The default is 600.

Configuration Parameters	Function
Watchdog	Enables the watchdog task on the Motherboard. The watchdog task monitors the MFIO point on the Model 8203 or Model 8217 and verifies it is scanning for gauges.
Dynamic Parameters	Function
Value1	Analog Value 1
Value2	Analog Value 2
Value3	Analog Value 3
Value4	Analog Value 4
Value5	Analog Value 5
Value6	Analog Value 6
Value7	Analog Value 7
Value8	Analog Value 8
PntStatus	Byte value indicating status of point. Values are: 0x0000: No Error 0x0001: No Response From Device.
Elapse	Time of last scan.
PntChecksum	CRC-16 Checksum for point's static Configuration Parameters

Application

The MFIO point continually scans the Allen Bradley Flex I/O device, using the ID parameter. The Module and Chan determine which Model 8203 Module and Channel are used for communications to the Allen Bradley. Module=1 corresponds to the Model 8203 set to address 1, etc. If the Module parameter is set to 0, the MFIO point will use one of the communications channels on the 8130 RTU Motherboard. An MFIO point is needed for each device connected to the 8130 RTU. Up to 8 Registers can be read with each MFIO point. The BaudRate and ComParams values must match the communications parameter of the Allen Bradley module.

Each point can read up to 8 consecutive register values, and write to 3 configuration addresses. The ReadCmd parameter determines the command to read data and the WriteCmd parameter is the command used for write operations. The Addr1 and Size1 parameters determine the read register values, while the Addr2-4 and Value2-4 determine the configuration values that can be written to the Allen Bradley. Set the Addr1 and Size1 parameters to read the data from the device. The response will be placed in the Value1-Value8 parameters. For example, if Addr1 = 1000 and Size1 = 6, then the MFIO point will read 6 values and place the data in Value1 - Value6. Likewise, if configuration data needs to be set, Addr2 - Addr4 sets the address to be written to, and Value_2 - Value_4 is the data written to that address. For example, if Addr2 = 1201 and Value_2 is 0x2222, a value of 0x2222 will be placed in the register address 1201.

Pulse Totalizer (PTOT)



The Pulse Totalizer counts pulse totals from discrete input sources such as the Model 8201 Digital Input/Output Module or the Model 8204 8-Channel Multi-Function Module.

Parameters

The database parameters used by the PTOT point are listed and described below.

Configuration Parameters	Function
Tag	A Tag can contain 15 bytes of data and can include any printable ASCII character. Tags can be used to identify points indicating the use of the point such as "Flow Meter" or "kW usage meter." The default tag is set to "PTOT.00".
Description	The point description can contain 30 bytes of data and can include any printable ASCII character. Descriptions can be used as information relevant to any aspect of the point, such as its use, location, operating information, etc. The default description is set to "PTOT.00"
Module	The input source of the pulses to be counted. Valid values are: 8201 - Model 8201 16 Channel Digital I/O Module 8204 - Model 8204 8 Channel Multi-Function Module
Channel	The physical input Channel (1-32). The default is to match the Point Name, i.e., PTOT.00 = Channel 1.
Port	The selected I/O port. This field is reserved for compatibility with existing Series 8150 FID systems and is ignored by the 8130 RTU.
Mode	Rate calculation mode. 0 will calculate the Rate parameter using changes in the Value and the time interval between scans. 1 will use the hardware registers and the real time interrupt to calculate the Rate. The default is 1. The Mode parameter only applies if the Module is the Model 8204.
Period	Totalization time period. Valid values are: One Hour Eight Hours One Day One Week The default is One Day.
Factor	Scaling factor, which allows for conversion of one set of units to another. For example, if the RefValue is gal/min, and the totalized value needs to be represented in barrels, a value may be entered into the Factor parameter which allows the conversion of gal/min to barrel/min. The Factor is applied prior to totalization. The default is 1.0.
ContactType	Specifies whether contact is Normally Open or Normally Closed. Valid values are NO or NC. If Normally Open (NO), counting takes place on contact closures. The default is NO. The ContactType only applies if the Module is 8201.
IntPeriod	The integration time period (in msec) used for the Rate calculation. For example, if the IntPeriod is set to 2500, then the Rate is calculated every 2.5 seconds. A longer IntPeriod yields a more accurate and stable Rate. The default is 5000 (5 seconds)
TimeUnits	Time Units used for the Rate calculation. Valid values are Seconds Minutes Hours DAYS. The TimeUnits parameter allows the used to set the time units for the Rate. For example, if the desired units for the Rate is GPM (gallons per minute), then set the TimeUnits to Minutes. The default is Seconds.
Report	Causes automatic notification to the Host (in response to a Change of State Request) when the Value changes State. Parameter value can be High, Low or No. Report=No disables notification. Points with Report = High will be sent before points with Report = Low. The default is No.

Configuration Parameters	Function
Maxtime	Specifies the maximum time (in secs) between automatic Change of State data being sent to the Host in response to a Change of State Request. Report must be set to either Low or High for the Value parameter to be sent in response to a Change of State Request. A value of 0 disables this option. Non-zero values cause responses to be sent even if the value has not changed since the last message. The maximum is 255 seconds. The default is 60.
Dynamic Parameters	Function
ResetCmd	ResetCmd is used to issue a reset. This command set the Value to 0.
Value	The totalized value for the current Period. If the Period is One Hour, then the channel will be totalized for one hour.
RawValue	The current scan total
State	The current input value of the channel
PrevValue	The previous period total
Rate	The rate of change of the pulse inputs. The Rate is determined using the IntPeriod, TimeUnits and Mode.
ResetTime	The period reset time
PntStatus	Byte value indicating status of point Values are: 0 – No Error
Elapse	Time of the last Change of State
PntCheckSum	CRC-16 Checksum for point's static Configuration Parameters.

Application

The PTOT point executes once a second, monitoring the value of the channel and storing the data locally in RawValue. This is added to the Value, which represents the total number of pulses accumulated during the Period. The Factor parameter may be used to introduce a scaling factor. For example, if each pulse is 1/100th of gallon, set the Factor to .01 and the Value will represent the total number of gallons totalized.

Rate represents the rate of change of the input. The Rate is calculated using the IntPeriod, the TimeUnits and the Mode. If the Mode is 0, then the Rate is calculated by software, using the RawValue and the Elapse parameter. If the Mode is 1, then the Rate is calculated using the hardware registers in the Model 8204 and the real time clock. The IntPeriod specifies how often the Rate calculation is performed. The longer the IntPeriod, the more accurate and stable the Rate will be. The TimeUnits parameter allows the user to specify whether the Rate is per second, minute, hour or day.

When the Period expires, the Value is shifted into PrevValue and Value is reset to 0 and totalization is re-initiated.

Interfacing to Other Points

The PTOT is often used as the input source (a Reference) for other point application programs. The Analog Alarm (AAL), Analog Status (AISTAT) and Min/Max/Average (SIGSEL) points are examples of points that use PTOT point data to calculate other data values or effect control.

Pump Status/Control (PUMP)



The Pump Status/Control point provides interface logic for use in common pump control applications. A number of operating conditions are considered, including vibration, flow rate, suction/discharge pressure and bearings/winding temperature.

Parameters

The database parameters used by the PUMP point are listed and described below.

Configuration Parameters	Function
Tag	A Tag can contain 15 bytes of data and can include any printable ASCII character. Tags can be used to identify points indicating the use of the point such as "Pump Control 1" or "PMP01." The default tag is set to "PUMP.00".
Description	The point description can contain 30 bytes of data and can include any printable ASCII character. Descriptions can be used as information relevant to any aspect of the point, such as its use, location, operating information, etc. The default description is set to "PUMP.00"
ValueRef	The pump status reference. This parameter must be defined in order for the PUMP point to operate. This is normally a DI point, although it can be any type of point that produces an On or Off value.
StartLink	The output Link for Start command. Normally a DO point is specified.
StopLink	The output Link for Stop command. Normally a DO point is specified.
HOARef	The Hand/Off/Auto reference. This parameter is used to enable or disable pump control as determined by the status of a Hand/Off/Auto switch. Normally a HOA point is used for this purpose, although any type of point that produces a value of Auto can be specified. The pump is only allowed to run if the value defined by the HOARef (the HOAValue) is Auto. If the pump is running and the HOAValue changes from Auto to anything else, the pump will be shut down. If the HOARef is not specified, then the PUMP point will operate as determined by other constraints. Note that defining the HOARef means that all constraints (VibrationRef, TempRef, PressRef, FlowRef, AlarmRef, TotalRef) are active only if the HOAValue is Auto.
VibrationRef	The Vibration status reference. This parameter is used for shutdown/lockout logic. Normally a DI point is used for this, although any type of point that produces a value of Normal can be specified. The value referenced by the VibrationRef is stored locally in the VibValue parameter. If the value of the VibrationRef is Normal, then the pump will be allowed to run. If the value of the VibrationRef is anything other than Normal (such as High or Alarm), the Command will be Stop and the pump will be shut down. If the VibrationRef is not specified, then the PUMP point will operate based upon other constraints.
TempRef	The Winding/Bearing temperature status reference. This parameter is used for shutdown/lockout logic. Normally a DI point is used for this, although any type of point that produces a value of Normal can be specified. For example, an AISTAT point can be used if the signal originates from an Analog Input point. If the value of the TempRef is Normal, then the pump will be allowed to run. If the value of the TempRef is anything other than Normal (such as High or Alarm), the Command will be Stop and the pump will be shut down. If the TempRef is not specified, then the PUMP point will operate based upon other constraints.
PressRef	The Suction Pressure status. This parameter is used for shutdown/lockout logic. Normally a DI point is used for this, although any type of point that produces a value of Normal can be specified. For example, an AISTAT point can be used if the signal originates from an Analog Input point. If the value of the PressRef is Normal, then the pump will be allowed to continue to run. If the value of the PressRef is anything other than Normal (such as High, Low or Alarm), the Command will be Stop and the pump will be shut down. If the FlowRef is not specified, then the PUMP point will operate based upon other constraints. The PressDelay is used to holdoff the logic decision so that startup conditions may stabilize.

Configuration Parameters	Function
FlowRef	The Flow status reference. This parameter is used for shutdown/lockout logic. Normally a DI point is used for this, although any type of point that produces a value of Normal can be specified. For example, an AISTAT point can be used if the signal originates from an Analog Input point. If the value of the FlowRef is Normal, then the pump will be allowed to continue to run. If the value of the FlowRef is anything other than Normal (such as High, Low or Alarm), the Command will be Stop and the pump will be shut down. If the PressRef is not specified, then the PUMP point will operate based upon other constraints. The FlowDelay is used to holdoff the logic decision so that startup conditions may stabilize.
AlarmRef	The AlarmRef allows the user to specify a reference to a DAL, AAL or other point that provides a coded value indicating an alarm status. The value specified by the AlarmRef is stored locally in the AlarmValue parameter. If the pump is running, an AlarmValue equal to anything other than Normal will shut the pump down. If the AlarmRef is not specified, then the PUMP point will operate based upon other constraints.
TotalRef	The TotalRef is a reference to a ATOT, PTOT or other point that provides a flow total value. The value specified by the TotalRef is stored locally in the FlowTotal parameter. When used in conjunction with the FlowSetPoint, the PUMP point can use a flow total to control pump operation. The PUMP point will issue a Reset command to the TotalRef to reset the ATOT or PTOT Value parameter to 0 when a pump Start command is issued.
ControlRef	The ControlRef is a reference to a point that provides a coded value of Enable and Disable. A DI point can be configured for this purpose, as well as a number of other point types. The value specified by the ControlRef is stored locally in the Control parameter. If the Control parameter is Enable, then the pump is allowed to start in response to a Start command. The user may also set the Control parameter is desired.
StatusDelay	The StatusDelay is the amount of time to wait before checking the ValueRef (the pump status) to see if the pump started. The data referenced by the ValueRef is stored locally in the Value parameter. After a Start command is issued, the PUMP point will wait the amount of time specified by the StatusDelay and check the ValueRef to ensure that the pump started properly. If the Value is anything other than On, then the pump will be stopped.
PressDelay	The amount of time after a Start command that the PressValue status is checked. The PressValue is derived from the PressRef reference. Normally, if the PressValue is not Normal, the pump will be stopped. Setting the PressDelay will hold off the shutdown decision immediately after a Start in order to allow the system to stabilize in the cases where flow switches are used. If the PressRef is not specified or if the PressDelay is 00:00:00, this feature is disabled.
FlowDelay	The amount of time after a Start command that the FlowValue status is checked. The FlowValue is derived from the FlowRef reference. Normally, if the FlowValue is not Normal, the pump will be stopped. Setting the FlowDelay will hold off the shutdown decision immediately after a Start in order to allow the system to stabilize. If the FlowRef is not specified or if the FlowDelay is 00:00:00, this feature is disabled.
TimeToStop	The TimeToStop parameter can be used as a condition for determining when to stop the pump. The TimeToStop is added to the CommandTime and at that time the pump will be stopped. The CommandTime is set when a Start Command is issued. This feature is useful to command the pump to run for a specific period, or can be used in conjunction with other parameters as a secondary means for pump shutdown. Setting the TimeToStop parameter to 00:00:00 disables this feature.

Configuration Parameters	Function
FlowSetPoint	The FlowSetPoint parameter sets a flow totalization goal, which determines when the pump is stopped. The FlowTotal is continually monitored and when the FlowTotal is greater than or equal to the FlowsetPoint, the pump is stopped. The TotalRef must be configured in order for this feature to work. Set the FlowSetPoint to 0 to disable this feature.
Report	Causes automatic notification to the Host (in response to a Change of State Request) when the Value Changes State. Parameter value can be High, Low or No. Report=No disables notification. Points with Report = High will be sent before points with Report = Low. The default is High.
Maxtime	Specifies the maximum time (in secs) between automatic Change of State data being sent to the Host in response to a Change of State Request. Report must be set to either Low or High for the Value parameter to be sent in response to a Change of State Request. A value of 0 disables this option. Non-zero values cause responses to be sent even if the value has not changed since the last message. The maximum is 255 seconds. The default is 120.
Dynamic Parameters	Function
Command	Pump Command. Valid values are Start and Stop.
Control	The Control parameter enables or disables operation of the pump.
Value	The current Pump status specified by the ValueRef.
AlarmStatus	If the pump is shut down due to an alarm condition, the AlarmStatus will be set to Alarm. Refer to the OpCondition for a more information. If the pump was stopped by the operator, or stopped due to the FlowSetPoint or the TimeToStop, the AlarmStatus will be Normal. The AlarmStatus is available for use as a reference to other Software Blocks.
CommandTime	Time of the last command. The CommandTime is used with the PressDelay, FlowDelay and StatusDelay parameters.
OpCondition	The current operating condition. Valid values are: 0: Pump Off 1: Vibration Alarm Shutdown 2: High Temp Alarm Shutdown 3: Pressure Alarm Shutdown 4: Flow Alarm Shutdown 5: Pump Start Initiated 6: HOA is not in Auto 7: Control is disabled 8: Pump Start Timeout 9: Pump Running 10: General Alarm Shutdown
AlarmControl	The AlarmControl parameter is an output of the PUMP point that is either Enable or Disable. The AlarmControl can be used as a ControlRef parameter in a DAL point to control the alarm operation. For example, the AlarmStatus would be the PntRef parameter for the DAL point. The AlarmControl could be assigned to the DAL point's ControlRef in order to enable and disable the alarm processing of the DAL point.
HOAValue	The current Hand/Off/Auto status as specified by the HOARef. If the HOARef is entered, then the pump is only allowed to run if the HOAValue is Auto.
VibValue	The current vibration status as specified by the VibrationRef. If the VibrationRef is entered, then the pump will run only if the VibValue is Normal.

Dynamic Parameters	Function
TempValue	The current temperature status as specified by the TempRef. If the TempRef is entered, then the pump will run only if the TempValue is Normal.
PressValue	The Pressure status as specified by the PressRef. If the PressRef is defined, then a check is made after a Start command to determine if the pressure is valid. The check is made after the PressDelay has timed out. The pump will continue to run only if the PressValue is Normal. If the Pressure signal originates from an Analog Input (or other type of point producing an analog value), then use an AISTAT point to convert the signal to a Low/High/Normal status.
FlowValue	The flow status as specified by the FlowRef. If the FlowRef is defined, then a check is made after a Start command to determine if the flow is valid. The check is made after the FlowDelay has timed out. The pump will continue to run only if the FlowValue is Normal. If the Flow signal originates from an Analog Input (or other type of point producing an analog value), then use an AISTAT point to convert the signal to a Low/High/Normal status.
AlarmValue	The value specified by the AlarmRef parameter. The AlarmValue will cause a pump shutdown if it is not Normal. If the AlarmRef is not defined, then the AlarmValue is not used in the control logic.
FlowTotal	The flow total as specified by the TotalRef. If the TotalRef is specified, then the value of the parameter referenced will be stored in the FlowTotal. This can be used in conjunction with the FlowSetPoint in order to control the operation of the pump.
PntStatus	Byte value indicating status of point Values are: 0: No error 15: Invalid Type for PntRef 16: Invalid Number for PntRef 17: Invalid Param for PntRef 19: PntRef point does not exist 25: PntRef is not defined
Elapse	Time of the last Change of State
PntCheckSum	CRC-16 Checksum for point's static Configuration Parameters

Application

The PUMP point provides status monitoring and control of commonly encountered pump applications. The PUMP point provides interface logic for Hand/Off/Auto switches, Bearing/Winding temperature monitoring, Vibration monitoring, as well as flow and pressure monitoring. Any or all of these signals may be specified for use with the PUMP point. If a signal is not present, it can be set to Undefined and it will be ignored.

The PUMP point allows the user to enter a Start or Stop by changing the Command parameter. This causes an On or Off value to be written to the parameter specified by the OutputLink. The PUMP point can also perform monitoring of other pump related parameters such as temperature, pressure and flow. If any of these parameters are outside of defined limits, then the pump is shut down.

Pump operation can also be determined by setting a flow total setpoint so that when the flow total is achieved, the pump is stopped. The PUMP point also includes a mode where the pump is command to run for a specified period of time.

Interfacing to Other Points

Note The ValueRef must be entered. If no status feedback is available, then define a DI point and assign it to the same channel as the DO point used for the OutputLink. This will allow the PUMP point to monitor the output command status.

The OutputLink is usually a DO point which is connected to the pump starter. Entering a Command of Start will cause the pump to start if no interlocks prevent operation. A Stop command will stop the pump.

The PUMP point provides for several interlocks. The VibrationRef may be entered which allows for shutdown of the pump if a vibration switch is activated. A DI point is usually used for this purpose. The VibValue needs to be Normal in order for the pump to operate. Set the Value_0 and Value_1 parameters of the DI point to Normal and Alarm. Alternatively, the Value_0 and Value_1 parameters can be set to Normal and High (as long as one state is defined as Normal the other state can be any valid coded value).

The bearings or winding temperature may also be monitored. The TempRef may be specified which will enable shutting down the pump if a temperature switch is activated. A DI point can be used, or if an analog input signal is used to measure the temperature, then a AISTAT point is used. The TempValue needs to be Normal in order for the pump to operate. For a DI based TempRef, set the Value_0 and Value_1 parameters to Normal and Alarm. If an AI point is used to measure the temperature, then use an interposing AISTAT point to set trip points for high and low operation. Set the TripHigh or TripLow parameter values to specify the valid operating range.

To check proper operation after a pump start, a FlowRef may be defined which will check for valid flow after a delay period (specified by FlowDelay). The FlowRef may be either a DI point, or an AISTAT point in the case of time-varying signals. The FlowValue needs to be Normal in order for the pump to continue to operate. If using a DI point, set the Value_0 and Value_1 parameters to Normal and Alarm, respectively. If an analog or pulse signal is used to measure flow, then use an interposing AISTAT point. Set the TripHigh or TripLow parameter values to specify the valid operating range.

A general purpose AlarmRef parameter is also included, which allows for an additional shutdown condition. The AlarmRef may be a DI or DAL point, or an AAL or AISTAT point in the case of time-varying signals. The FlowValue needs to be Normal in order for the pump to continue to operate. If using a DI point, set the Value_0 and Value_1 parameters to Normal and Alarm, respectively. If an analog or pulse signal is used to measure flow, then use an interposing AISTAT point. Set the TripHigh or TripLow parameter values to specify the valid operating range.

The suction or discharge pressure may also be checked. The PressRef may be defined which will check for valid pressure after a delay period (specified by PressDelay). The PressRef may be either a DI point, or an AISTAT point in the case of time-varying signals. The PressValue needs to be Normal in order for the pump to continue to operate. If using a DI point, set the Value_0 and Value_1 parameters to Normal and Alarm, respectively. If an analog signal is used to measure pressure, then use an interposing AISTAT point to define valid operating conditions.

The PUMP point can be configured to operate based upon achieving a flow total by specifying a TotalRef. In this case the operator sets the FlowSetPoint and issues a pump Start command. The PUMP point will then issue a Reset command to the TotalRef, start the pump and allow it to run until the FlowTotal equals the FlowSetPoint.

The PUMP point has a mode where the operation is controlled based upon the pump runtime. The user sets the TimeTostop and the pump will run until the period expires. This mode can be used independently, or in conjunction with the FlowSetPoint.

The AlarmStatus and AlarmControl are available as outputs to other types of points, such as a DAL point. The AlarmStatus and AlarmControl parameters can be used by the DAL point to activate an output to indicate and alarm condition exists.

The PUMP point is one of the most sophisticated Software Blocks in the 8130 RTU. It can interact with several other points in order to construct a complex control strategy.

Scaler Point (SCALER)



The Generic Scaling point allows the user to perform math functions in the 8130 RTU. The SCALER point monitors one or more database reference values and performs an equation in the form:

$$\text{Value} = Ax + By + Cz + K$$

A, B, C & K are user entered constants.

x, y & z are inputs from other database points.

Parameters

The database parameters used by the SCALER point are listed and described below.

Configuration Parameters	Function
Tag	A Tag can contain 15 bytes of data and can include any printable ASCII character. Tags can be used to identify points indicating the use of the point such as "Eng Converter". The default tag is set to "SCALER.00".
PntRef1 PntRef2 PntRef3	The PntRef parameters determine the input source for the SCALER point to monitor. Up to three references may be specified. RefValue1 is the X term, PntRef2 is the Y term, and PntRef3 is the Z term. If a reference is not specified, then it is not used in the equation.
A	Constant that is multiplied with RefValue1. The default value is 1.
B	Constant that is multiplied with RefValue2. The default value is 1.
C	Constant that is multiplied with RefValue3. The default value is 1.
K	Constant K. The default value is 0.
Deadband	Change of State deadband. The default value is 0.1.
Report	Causes automatic notification to the Host (in response to a Change of State Request) when the Value changes State. Parameter value can be High, Low or No. Report=No disables notification. Points with Report = High will be sent before points with Report = Low. The default is No.
Maxtime	Specifies the maximum time (in secs) between automatic Change of State responses being sent to the Host. Report must be set to either Low or High for the Value parameter to be sent in response to a Change of State Request. A value of 0 disables this option. Non-zero values cause responses to be sent although the value may have not changed since the last message. The default is 60.
Dynamic Parameters	Function
Value	Output value for the SCALER point. Value = Ax + By + Cz + K. x corresponds the RefValue1, y is RefValue2, and z is RefValue3.
RefValue1 RefValue2 RefValue3	RefValue1 – 3 are the values of the PntRef1 – 3 parameter references. The references can be to any point that produces a floating point value.
Value1	Value parameter converted to Integer format.

Dynamic Parameters	Function
PntStatus	Byte value indicating status of point Values are: 0: No error 15: Invalid Type for PntRef 16: Invalid Number for PntRef 17: Invalid Param for PntRef 19: PntRef point does not exist 25: PntRef is not defined
Elapse	Time the SCALER point last executed.
PntChecksum	CRC-16 Checksum for point's static Configuration Parameters

Application

The SCALER point allows the user to perform simple math functions such as conversion of units. The SCALER point takes the value from user specified database references, multiplies each by a constant and adds the three product terms. A constant K may also be factored in. The SCALER point works in conjunction with parameters that are in floating point format.

Interfacing to Other Points

The SCALER point is often used as the input source (a Reference) for other point application programs. The Tank (TANK), Modbus Floating Point Register (MFPREG), and Modbus Integer Register (MIREG) points are examples of points that can use the SCALER point data to calculate other data values.

Signal Selector (SIGSEL)



The Signal Selector Point monitors multiple floating point values from AI or other points and calculates the Minimum, Maximum or Average value.

Parameters

The database parameters used by the SIGSEL point are listed and described below.

Configuration Parameters	Function
Tag	A Tag can contain 15 bytes of data and can include any printable ASCII character. Tags can be used to identify points indicating the use of the point such as "High Temp Alarm" or "Hi Level Alarm." The default tag is set to "SIGSEL.00".
Mode	Operational mode for the SIGSEL. Valid choices are Minimum, Maximum, and Average. The default value is Average.
ValueMin	Minimum Reference Value. If the value is less than the ValueMin, it will be ignored. The default value is -100.
ValueMax	Maximum Reference Value. If the value is more than the ValueMax, it will be ignored. The default value is 200.
PntRef1-8	Input point reference for the SIGSEL point to monitor. The SIGSEL point interfaces to floating point data values.
LevelRef	If defined, the LevelRef is an input point reference used to enable or disable the use of the Value1-8 data associated with PntRef1-8. Level1-8 are used to define the level for PntRef1-8.
Level1-8	Level1-8 are constants used with the LevelRef to qualify the use of the Value1-8 when calculating the Minimum, Maximum and Average value.

Configuration Parameters	Function
Deadband	Change of State Deadband. The default value is 0.2.
Report	Causes automatic notification to the Host (in response to a Change of State Request) when the Value changes State. Parameter value can be High, Low or No. Report=No disables notification. Points with Report = High will be sent before points with Report = Low. The default is No.
Maxtime	Specifies the maximum time (in secs) between automatic Change of State data being sent to the Host in response to a Change of State Request. Report must be set to either Low or High for the Value parameter to be sent in response to a Change of State Request. A value of 0 disables this option. Non-zero values cause responses to be sent even if the value has not changed since the last message. The maximum is 255 seconds. The default is 60.

Dynamic Parameters	Function
Value	Floating point value representing the Minimum, Maximum or Average (set by the Mode parameter) of the PntRef values.
RefValue1-8	Floating Point value of a PntRef parameter used to determine the Value parameter
Level	Level value read from the LevelRef parameter.
StausFlag	Bit status that displays the current reference values being used to determine the output value.
ErrorCode	Error Code. 0 means no errors, otherwise an error code will be displayed.
PntStatus	Byte value indicating status of point Values are: 0: No error 15: Invalid Type for PntRef 16: Invalid Number for PntRef 17: Invalid Param for PntRef 19: PntRef point does not exist 25: PntRef is not defined
Elapse	Time of the last Change of State
PntChecksum	CRC-16 Checksum for point's static Configuration Parameters

Application

The SIGSEL point continually monitors the value of the PntRef1 – PntRef8 references and stores the data locally in RefValue1 – RefValue8. If the Mode is set to Average, then the average of the RefValues is calculated. If the Mode is set to Maximum, then the maximum value is calculated and stored in Value. If the Mode is set to Minimum, then the minimum value is calculated and stored in Value. If a PntRef is not defined, then it is ignored.

The LevelRef parameter can be used to qualify the RefValue1 – RefValue8 parameters in the calculation. The Level1 – Level8 constants represent levels associated with the PntRef1 – PntRef8 parameters. If the Level read from the LevelRef is above a particular level constant (Level1 – Level8) constant, then the associated reference value (RefValue1 –RefValue8) is included in the calculation.

The SIGSEL point is useful when multiple sources of input are available and the user wants to effect control based upon the average, minimum or maximum of those values. An example is a Bulk Storage Tank where there are several temperature sensors. The user can perform volume correction calculations and use the average of three or four sensors. The LevelRef is defined as the tank level associated with a tank gauge interface point. The Level constants (Level1–Level8) define the heights of the temperature sensors installed on the tank. The temperature values

(RefValue1–RefValue8) are used in the calculation if their Level constant (Level1–Level8) is below the current Level value.

Interfacing to Other Points

The SIGSEL point can be used in conjunction with any points that produce floating point data values. Typical examples are the Analog Input (AI) and TankGate points.

System Information (SYS)



The System Information Point lists the hardware and software specifications of the system. Other information includes the hardware version and any connected devices.

Parameters

The database parameters used by the SYS point are listed and described below.

Configuration Parameters	Function
RTUTag	8130 RTUTag can contain 15 bytes of data and can include any printable ASCII character.
DBFile	The database file name. DBFile is the name of the RCF database configuration file.
DBVer	The database version.
AutoDetect	Enable/Disable auto detection of I/O modules installed on the 8130 RTU. Default is Disable.
PntEnable	Disable/Enable execution of points. Default is Enable.
AlgEnable	Disable/Enable execution of algorithms. Default is Enable.
OutputEnable	Disable/Enable Outputs. Default is Enable.
AIscanEnable	Disable/Enable Analog Input scanning. Default is Enable.
DIScanEnable	Disable/Enable Digital Input scanning. Default is Enable.
Override	Communication failure override. Default is Enable.

Dynamic Parameters	Function
UnitAddr	The 8130 RTU Unit Address (SW1).
DBPnts	The number of database points defined.
DBSize	The size of the database in bytes.
DBChanging	The initial time of database modification.
DBChanged	The completion time of database modification.
DBChangeTime	The time of last database modification.
SysVer	The Firmware version.
SysChecksum	The System Checksum.
HardVer	The PCB hardware version.
PSDVer	The programmable logic version.
HART	HART Modem circuit is present.
NumResets	Records the number of resets that have occurred.
RAMSize	Size of installed system scratch memory (kilobytes).
NOVRAMSize	Size of installed system nonvolatile database memory (kilobytes).

Dynamic Parameters	Function
FlashSize	Size of installed system program memory (kilobytes).
PntChecksum	CRC-16 Checksum for point's static Configuration Parameters.

Event Timer/Counter (TIMER)



The Event Timer/Counter point provides counting and timing functions. The TIMER point has four timers. Each timer counts events of a reference point to a user-specified comparator. The TIMER point is useful for counting pump and valve operations.

Parameters

The database parameters used by the TIMER point are listed and described below.

Configuration Parameters	Function
Tag	A Tag can contain 15 bytes of data and can include any printable ASCII character. Tags can be used to identify points indicating the use of the point such as "Pump Cycles" or "# Valve Ops." The default tag is set to "TIMER.00".
Description	The point description can contain 30 bytes of data and can include any printable ASCII character. Descriptions can be used as information relevant to any aspect of the point, such as its use, location, operating information, etc. The default description is set to "TIMER.00".
PntRef	Point reference for timing and counting functions. Any point which produces a coded data type can be used.
Compare0	Compare0 specifies the values to be timed or counted. This value should represent valid states of the PntRef. For example, if the PntRef is a pump, then Compare0 and Compare1 can be set to On and Off in order to calculate the pump runtime.
AlarmTime0	AlarmTime0 specifies the amount of time before Compare0 is in alarm. The AlarmTime is used with the TimeUnits parameters.
Compare1	Compare1 specifies the values to be timed or counted. This value should represent valid states of the PntRef. For example, if the PntRef is a pump, then Compare0 and Compare1 can be set to On and Off in order to calculate the pump runtime.
AlarmTime1	AlarmTime1 specifies the amount of time before Compare1 is in alarm. The AlarmTime is used with the TimeUnits parameters.
Compare2	Compare2 specifies the values to be timed or counted. This value should represent valid states of the PntRef. For example, if the PntRef is a pump, then Compare0 and Compare1 can be set to On and Off in order to calculate the pump runtime.
AlarmTime2	AlarmTime2 specifies the amount of time before Compare2 is in alarm. The AlarmTime is used with the TimeUnits parameters.
Compare3	Compare3 specifies the values to be timed or counted. This value should represent valid states of the PntRef. For example, if the PntRef is a pump, then Compare0 and Compare1 can be set to On and Off in order to calculate the pump runtime.
AlarmTime3	AlarmTime3 specifies the amount of time before Compare3 is in alarm. The AlarmTime is used with the TimeUnits parameters.
TimeUnits	The TimeUnits is used in conjunction with the AlarmTime0-3 parameters to determine the status of the Alarm0-3 parameters.

Configuration Parameters	Function
Period	Totalization time period. Valid values are: One Hour Eight Hours One Day One Week The default is One Day.
Report	Causes automatic notification to the Host (in response to a Change of State Request) when the Value Changes State. Parameter value can be High, Low or No. Report=No disables notification. Points with Report = High will be sent before points with Report = Low. The default is No.
Maxtime	Specifies the maximum time (in secs) between automatic Change of State data being sent to the Host in response to a Change of State Request. Report must be set to either Low or High for the Value parameter to be sent in response to a Change of State Request. A value of 0 disables this option. Non-zero values cause responses to be sent even if the value has not changed since the last message. The maximum is 65525 seconds. The default is 240.
Dynamic Parameters	Function
ResetCmd	ResetCmd is used to issue a reset. This command returns the value in Value to 0.
RefValue	The value of the parameter specified by PntRef.
Value0-Value3	Value0-Value3 are the current values for each timer. This value is in HH:MM:SS format. For example, Value0 will accumulate whenever the value specified by the PntRef matches the Compare0 value. This timer will continue to run until the PntRef and Compare0 no longer match. Value0 is reset when the Period expires.
PrevValue0-3	PrevValue0-3 are the previous period timer totals. When the Period expires, Value0-3 will be copied into PrevValue0-3
Counter0-3	Counter0-3 are the number of transitions counted for each timer
PrevCounter0-3	The number of transitions for the previous Period. When the Period expires, Counter0-3 will be copied into PrevCounter0-3
Alarm0-3	The status of each timer. If the Value for each timer is greater than the AlarmTime, the Alarm parameter will be set to Alarm.
ResetTime	The next Period reset time
PntStatus	Byte value indicating status of point Values are: 0: No error 15: Invalid Type for PntRef 16: Invalid Number for PntRef 17: Invalid Param for PntRef 19: PntRef point does not exist 25: PntRef is not defined
Elapse	Time of the last Change of State
PntChecksum	CRC-16 Checksum for point's static Configuration Parameters

Application

The TIMER point allows the user to count and/or time events. Alarms, Pump Control operations, Valve operations and Digital status changes are all examples of events that the TIMER point can time.

The user specifies a PntRef which is stored locally in RefValue. Up to four values to compare are also specified. If the RefValue equals one of the Compare parameters, the Value for that timer

increments. At the transition from false to true for a timer, the Counter for the timer is incremented. After the time designated by the Period elapses, the Value and Counter parameters are stored to PrevValue0–3 and Counter0–3.

The AlarmTime0–3 is used to set time-out values for each of the four timers. The TimeUnits parameter is used to determine whether the AlarmTime is in Minutes, Hours, or Days.

Interfacing to Other Points

The PntRef specifies which point the TIMER point will time. The point parameter being referenced must be in coded data format.

Tag Register (TREG)



The Tag Register point provides four bytes of storage in the character format. It is often used for inter-point communications where no other means is provided.

Parameters

The database parameters used by the TREG point are listed and described below.

Dynamic Parameters	Function
Value	30 character text string

Unsigned Long Integer Register (ULREG)



The Unsigned Long Integer Register point provides four bytes of storage. It is often used for inter-point communications where no other means is provided.

Parameters

The database parameters used by the ULREG point are listed and described below.

Dynamic Parameters	Function
Value	Unsigned Long integer (4 bytes) value

Valve Status/Control (VALVE)



The Valve Status/Control point provides interface logic for use in common valve control applications. The VALVE point parameters include a maximum transition time and reserve coastdown.

Parameters

The database parameters used by the VALVE point are listed and described below.

Configuration Parameters	Function
Tag	A Tag can contain 15 bytes of data and can include any printable ASCII character. Tags can be used to identify points indicating the use of the point such as "Valve 1" or "VCP01." The default tag is set to "VALVE.00".

Configuration Parameters	Function
Description	The point description can contain 30 bytes of data and can include any printable ASCII character. Descriptions can be used as information relevant to any aspect of the point, such as its use, location, operating information, etc. The default description is set to "VALVE.00".
OpenedRef	The 'Opened Status' limit switch reference. Either this parameter or the ClosedRef must be defined in order for the VALVE point to operate. This is normally a DI point, although it can be any type of point that includes a RawValue of 0 or 1.
ClosedRef	The 'Closed Status' limit switch reference. Either this parameter or the OpenedRef must be defined in order for the VALVE point to operate. This is usually a DI point, although it can be any type of point that includes a RawValue of 0 or 1.
HOARef	The Hand/Off/Auto reference. This parameter is used to enable or disable valve control as determined by the status of a Hand/Off/Auto switch. Normally a HOA point is used for this purpose, although any type of point that produces a value of Auto can be specified. The valve is only allowed to operate if the value defined by the HOARef is Auto. If the HOARef is not specified, then the VALVE point will operate as determined by other constraints.
PositionRef	Reference to an AI or similar point that provides a position feedback. This can be used in conjunction with the SetPoint parameter to control the valve using a position setpoint. The value referenced by the PositionRef is stored locally in the ValvePosition.
Mode	Sets Operating mode of the Valve. Valid values are Hold or Stop.
DataMode	Sets the Operating Condition Offset.
CoastDown	The reverse command coastdown This allows the user to set a timer that is used in the case of a Reverse command. The value is specified in HH:MM:SS format. The default is 10 seconds.
TransTimeOut	The transition time maximum. This causes a Stop command to be issued if the valve is in transition (either Opening or Closing) longer than the TransTimeOut. The value is specified in HH:MM:SS format. The default is 2 minutes.
OpenLink	The output link for Open commands. Normally a DO point is specified.
CloseLink	The output link for Close commands. Normally a DO point is specified.
Reverse	Reverses the operation of the valve. An Open command will close the valve and a Close command will open the valve. This parameter can be set to Yes or No. The default value is No.
Report	Causes automatic notification to the Host (in response to a Change of State Request) when the Value Changes State. Parameter value can be High, Low or No. Report=No disables notification. Points with Report = High will be sent before points with Report = Low. The default is High.
Maxtime	Specifies the maximum time (in secs) between automatic Change of State data being sent to the Host in response to a Change of State Request. Report must be set to either Low or High for the Value parameter to be sent in response to a Change of State Request. A value of 0 disables this option. Non-zero values cause responses to be sent even if the value has not changed since the last message. The maximum is 255 seconds. The default is 120.
Dynamic Parameters	Function
Command	Valve Command. Valid values are Open, Close, Stop and Reverse.
SetPoint	If the PositionRef is defined, then the user can enter a position setpoint and the VALVE point will drive the valve to the SetPoint.
LastCommand	Last command issued
CommandTime	Time of last command

Dynamic Parameters	Function
Value	Valve status. This parameter is derived by using the OpenedRef and ClosedRef to produce one of 4 states: Opened – Valve is fully opened Closed – Valve is fully closed Opening – Valve is in transition from Closed to Opened Closing – Valve is in transition from Opened to Closed
OpCondition	The current operating condition. Valid values are: 0: Normal 1: Valve time-out 2: Unauthorized movement 3: HOA is not in Auto 4: Reversing direction 5: Open command in progress 6: Close command in progress 7: Valve Stop command issued
HOAValue	The current Hand/Off/Auto status as specified by the HOARef. If the HOARef is entered, then the valve is only allowed to operate if the HOAValue is Auto.
ValvePosition	Value of the parameter referenced by the PositionRef. The ValvePosition can be used in conjunction with the SetPoint in order to control the valve.
PntStatus	Byte value indicating status of point Values are: 0: No error 15: Invalid Type for PntRef 16: Invalid Number for PntRef 17: Invalid Param for PntRef 19: PntRef point does not exist 25: PntRef is not defined
Elapse	Time of the last Change of State
PntChecksum	CRC-16 Checksum for point's static Configuration Parameters

Application

The VALVE point provides status monitoring and control of commonly encountered valve applications. The VALVE point provides interface logic for Hand/Off/Auto switches, as well as reverse coastdown and transition timers. Any or all of these parameters or signals may be specified for use with the VALVE point. If a signal or parameter is not present, it can be set to Undefined and it will be ignored.

The VALVE point allows the user to enter an Open, Close, Reverse or Stop by changing the Command parameter. Entering a Command of Open will cause valve to open. Likewise, a Command of Close will cause the valve to close.

The Command parameter causes an On or Off value to be written to the parameter specified by the OpenLink and ClosedLink parameters. A Stop command will immediately stop the valve. The valve will not change position until a new command is issued. A Reverse command will reverse the last command. In this case a CoastDown timer can be specified that will cause the VALVE point to wait before issuing the opposite command as the last operator command. The user can specify a value for the TransTimeOut, which will cause a Stop command to be issued if the valve is in the Opening or Closing state to long, indicating a possible stuck valve.

In addition to Open & Close commands, the user can enter a SetPoint command which will cause the VALVE point to drive the outputs until the setpoint is achieved. The PositionRef must be defined for this feature to function.

Interfacing to Other Points

Either the OpenRef or ClosedRef must be entered. If only one is specified, then the valid states for the Value parameter will be Opened or Closed. If both are available, both can be used to determine transitional status. If no status feedback is available, then define a DI point and assign it to the same channel as the OpenLink. This will allow the VALVE point to monitor the output command status.

The OpenLink is usually a DO point which is connected to the valve actuator via a Model 8201 16 Channel Digital I/O Module or a Model 8204 8 Channel Multi-Function Module. Entering a Command of Open will cause valve to open. Likewise, a Command of Close will cause the valve to close.

The PositionRef is usually an AI point, although any Software Block that produced an IEEE floating point value indicating the valve position (0-100%) can be used.

Comm Watchdog (WDOG)



The Communications Watchdog point allows the user to enable communications failure processing for the 8130 RTU. The WDOG point monitors one or more database reference values and if it is determined that the Host is not communicating, comm failure processing can be initiated. The WDOG point typically monitors the COM points.

Comm Failure processing affects AO and DO points. AO and DO points have a parameter called the CommFailValue. When the WDOG point signals all the AO and DO points that communications has failed, they respond by setting their output to the CommFailValue. If the CommFailValue is 0 or Undefined, then no action will take place for that particular point.

Parameters

The database parameters used by the WDOG point are listed and described below.

Configuration Parameters	Function
Tag	A Tag can contain 15 bytes of data and can include any printable ASCII character. Tags can be used to identify points indicating the use of the point such as "Comm Watchdog". The default tag is set to "WDOG.00".
Description	The point description can contain 30 bytes of data and can include any printable ASCII character. Descriptions can be used as information relevant to any aspect of the point, such as its use, location, operating information, etc. The default description is set to "WDOG.00"
Mode	Operating Mode. If Mode = 1, then all of the RefValues defined must be 'Offline' in order for Comm Fail processing to take place. Use this in the case of redundant comm links to the host. If Mode = 2, then any of the RefValues defined can be 'Offline' in order for Comm Fail processing to occur.
TimeOut	Amount of time that the Offline condition exists before the notifications to turn off outputs are sent. The default is 30 seconds.
PntRef1 -PntRef4	The PntRef parameters determine the input source for the WDOG point to monitor. Up to four references may be specified. The Mode parameter determines how the WDOG point responds. The PntRef must be to a point that produces a coded value. The typical reference is to COM.xx.CommStatus. Other point types may be used with the main criteria since the value 'Offline' is state defined for comm fail processing.

Dynamic Parameters	Function
CommStatus	Communications status. The CommStatus is determined by the RefValues and the Mode parameter. If Mode = 1, then all of the RefValues must be Offline in order for comm fail processing to occur. If Mode = 2, then any of the RefValues can be offline for comm fail processing.
Control	If the Control is set to Disable, then the WDOG point is disabled and no comm fail processing will take place.
RefValue1-RefValue4	RefValue1 - 4 are the values of the PntRef1 - 4 parameter references. The references can be to any point that produces a coded value. Furthermore, the only value that has any meaning is a value of 'Offline'. A DI, CREG or other point type can be configured to produce a coded value.
PntStatus	Byte value indicating status of point Values are: 0: No error 15: Invalid Type for PntRef 16: Invalid Number for PntRef 17: Invalid Param for PntRef 19: PntRef point does not exist 25: PntRef is not defined
Elapse	Time the WDOG point last executed.
PntChecksum	CRC-16 Checksum for point's static Configuration Parameters

Application

The WDOG point is the means a user has to turn off outputs if the 8130 RTU goes offline. The WDOG point monitors a COM or other point and if the CommStatus goes to Offline, the WDOG point will notify all the DO and AO points. The DO and AO points then determine individually what their response to the offline condition will be. The DO and AO points can either ignore the notification and do nothing or set their output to the value specified in the CommFailValue.

7 Using ViewRTU

This chapter describes the software used to configure the 8130 RTU. This chapter describes each of the menus found in the menu bar. Additionally, the chapter describes the system requirements and the installation procedure. Use this chapter in accordance with the 8130 RTU Software Blocks section.

ViewRTU software, a Microsoft Windows application, is designed to configure and view data points in the 8130 RTU. ViewRTU is a utility program that can be used for configuration, diagnostics, data acquisition and control. Because ViewRTU follows the Windows standard, the user that is familiar with Windows is able to learn the program quickly. ViewRTU supports the Windows standard of selecting commands from a series of pull-down menus. If the user is not familiar with Windows-based programs, then refer to the Microsoft Windows manual for basic instruction.

System Requirements

The minimum requirements needed to run the ViewRTU application are listed below:

- 386/486/Pentium Personal Computer
- Microsoft Windows NT, 2000, XP, or Windows 7
- 96 MB RAM
- 2 MB free disk space
- 1 Com Port

Installing ViewRTU

To install the ViewRTU application, follow the steps listed below.

Installing ViewRTU

1. Insert the CD into the CDROM or DVDROM drive.
2. Select the drive that contains the disk from the Windows File Manager.
3. Double click on the SETUP.EXE file. The setup program prompts the user for the drive and directory used to install the software.
4. Select the drive and type in the directory name. Once the drive and directory are selected, the setup program copies all of the files to the chosen destination.
5. When all of the files have been copied to the destination, the setup program automatically builds a program group with corresponding program items in the Windows Program Manager.

Executing ViewRTU



This section describes how to start up the ViewRTU program. The components of the window are also described in this section.

Execute the ViewRTU program

1. Select the ViewRTU program group from the Windows Program Manager.
2. Double-click on the icon to execute the ViewRTU application.

If more than one 8130 RTU definition file (DVR) exists, the following dialog box is displayed.

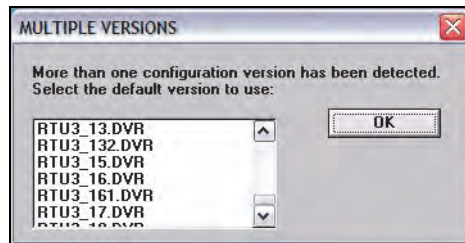

Figure 7-1: ViewRTU Version Selection Dialog

Each version file contains setup information that matches the firmware in the 8130 RTU. This information allows a single version of ViewRTU to configure multiple versions of the 8130 RTU. For example, MSTG1_00.DVR is a definition file that is compatible with 8130 RTU firmware version 1.00. Select the version that matches the version of firmware in the 8130 RTU. Note that you can determine the firmware version by viewing the SysVer parameter of the SYS point.

3. Choose the desired version and select OK.

If only one 8130 RTU definition file (DVR) exists, the main window appears instead. The main window is seen below.

When the ViewRTU program is opened, a new file appears in the window. The components of this window are explained below.

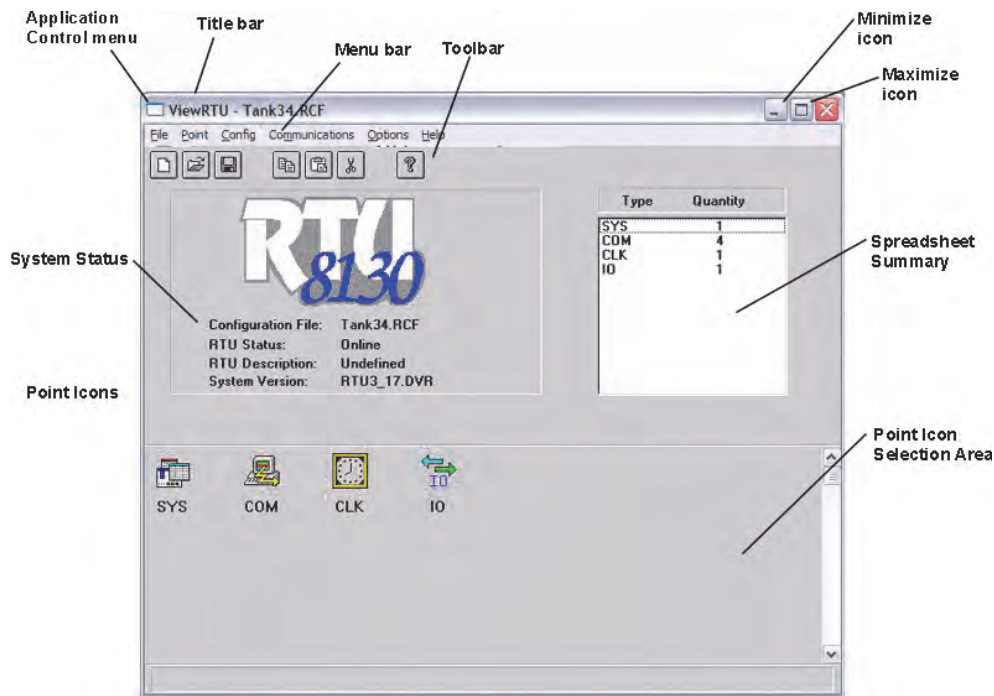

Figure 7-2: Main ViewRTU Window with Descriptions

ViewRTU Window

This main window allows the user to configure the 8130 RTU. The ViewRTU window contains the standard Windows components such as the Application Control menu, minimize/maximize icon buttons, title bar, and menu bar.

The System Status Area

Displays the system version as well as general information about the configuration file. The 8130 RTU file name is found in both the System Status area and the title bar.

The Toolbar

Contains several icons used to execute frequently used commands found in the menu bar. In the menu description below, each appears next to its associated menu option.

The Spreadsheet Summary

Lists all the point types and corresponding number defined in the file. The Spreadsheet Mode can be used as a quick method for creating and editing the contents of each point by double-clicking the desired point type. The parameters listed in the Spreadsheet summary directly correlate with each defined point.

Point Icon Selection Area

All the point icons are displayed in the Point Icon Selection Area. Point icons are visual representations of various software functions. When a new file is opened, several default point icons are displayed in the Point Icon Selection Area. These points are described in the 8130 RTU Software Blocks chapter.

The ViewRTU Menu Bar

This section describes all the menus found in the ViewRTU menu bar. The icons found in the Toolbar are shown next to each associated menu option. This section primarily describes the functionality of each menu option. ViewRTU applications are presented in the Application section at the end of the chapter.

The File Menu

The File menu allows the user to create, open, and save configuration files. This menu also allows the user to save the current configuration to a different file name

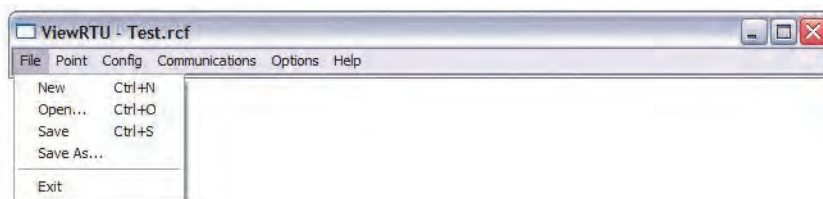

Figure 7-3: The File Menu

New



The user is able to create a new configuration file by clicking the New icon from the tool bar or by selecting New from the File menu. When selected, a dialog box appears displaying a list of configuration definition files. The user selects the desired file from this list.

Open



The user is able to select an existing configuration file by clicking the Open icon from the tool bar, or by selecting Open from the File menu. When selected, a dialog box appears displaying a list of configuration files. All configuration files are identified by the RCF extension. Once a file is selected, the point configuration data of the selected file is displayed. If the directory is empty, the user has the option of creating a new file by typing in the file name.

Save



The user is able to save the opened configuration file by clicking the Save icon from the tool bar or by selecting Save from the File menu. The user can save the file anytime the configuration has changed. If the file exists in the directory, the configuration is stored to the disk using the current file name. If the file has not been saved before or the name does not exist in the directory, the user is prompted to enter a configuration file name.

Save As

The Save As option is used to save the currently opened file under a different name. When selected, a dialog box appears prompting the user to enter a file name. If the selected file name already exists, the user has the option of overwriting the file. Otherwise, the user can create a separate file containing all the current configuration data of the present file. If the user chooses to create a separate file, the current file is automatically closed. Only one file may be open at a time.

Exit

The Exit option is used to close the ViewRTU application. If the current configuration file has not been saved, the user is prompted to save the file or cancel the option.

The Point Menu

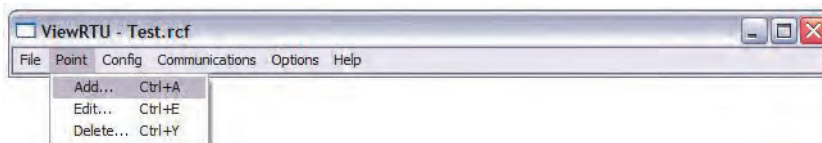

Figure 7-4: The Point Menu

Add



The user is able to add a point to the current configuration. The user is able to add a point by clicking the Add Point icon from the tool bar or by selecting Add from the Point menu. The Select Point to Add dialog box appears:

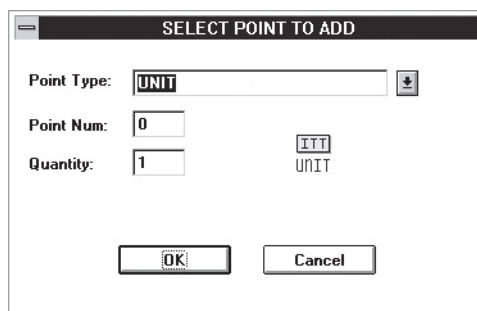

Figure 7-5: Dialog Viewed when Adding a New Point

Select Point to Add Dialog Box

This dialog box displays a list of available point types, the point number, quantity and the corresponding point icon. The point icon is then added to the Point Icon Selection Area if it does not already exist. The Point Type lists the currently selected point. The user can select the desired point by selecting the point from the scroll list.

The Point Number defaults to “0” if the point type has just been defined. The maximum number of points entered depends on the selected point type. Once entered, the point quantity is displayed in the Summary Spreadsheet.

Multiple points of the selected type may be created simultaneously by entering the number in the Quantity edit box.

Edit



This option is used to modify the contents of a selected point. The user is able to edit an existing point by clicking the Edit icon from the toolbar or by selecting Edit Point from the Point menu. The Select Point to Edit dialog box appears:

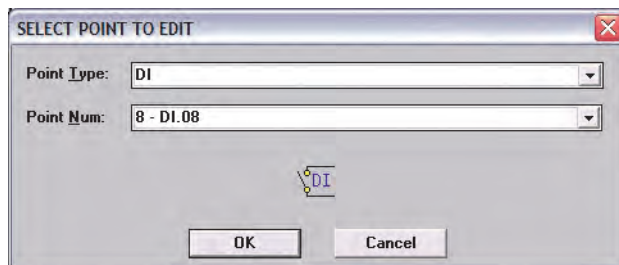

Figure 7-6: Edit Point Selection Dialog

Edit Point Selection Dialog

This dialog box displays a list of defined point types and corresponding point numbers. The point icon is also displayed for identification as well as the tag, if a tag has been assigned.

Once a point is selected, the Edit Point dialog box appears:

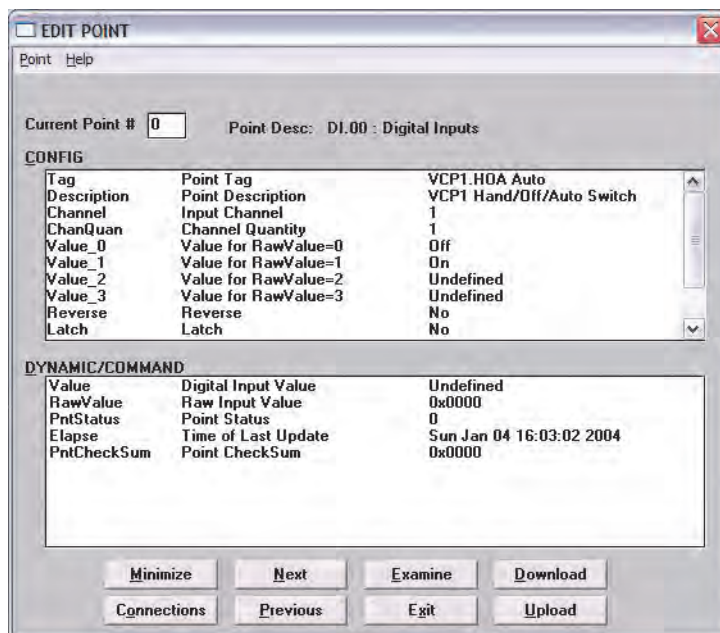

Figure 7-7: Edit Point Dialog

Edit Point Dialog

This dialog box contains all dynamic and configurable field information. The user is able to edit point data. Exiting this dialog box returns the user to the main window.

Note Several other methods can be used to display the Edit Point dialog box. These methods and other information are explained in greater detail in the Application section.

Delete



This option lets the user delete one point at a time. The user is able to delete an existing point by clicking the delete icon from the toolbar or by selecting Delete Point from the Point menu. The Select Point to Delete dialog appears:

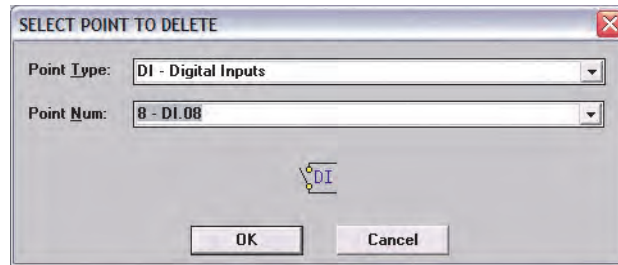

Figure 7-8: Point Deletion Dialog

Point deletion dialog

This dialog box displays a list of defined point types and corresponding point numbers. The point icon is also displayed for identification as well as the tag, if a tag has been assigned.

The user selects the point type and the corresponding number to be deleted.

The Config Menu

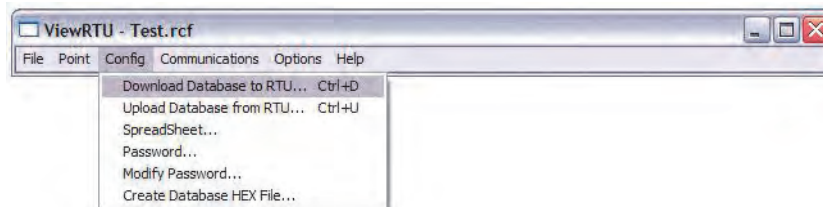

Figure 7-9: The Configuration Menu

Download Database to RTU

The Download Database to RTU option is used to download configuration data to the 8130 RTU. The following dialog box appears:

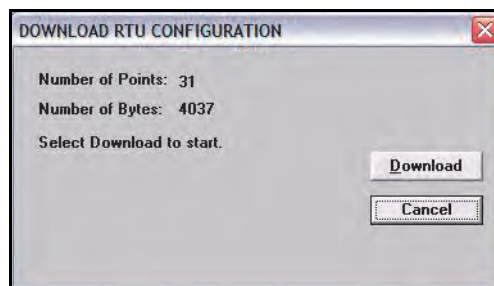

Figure 7-10: Dialog used to Download 8130 RTU Data

Click the **Download** to download data to the 8130 RTU

Upload Database from 8130 RTU

The Upload option is used to upload configuration data from the 8130 RTU. The following dialog box appears:

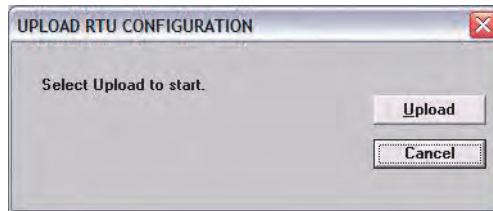

Figure 7-11: Dialog used to Upload 8130 RTU Data

Click the Upload icon to download data from the 8130 RTU. Once the upload is complete, the main window changes to display the uploaded configuration.

Spreadsheet

The Spreadsheet option is used to configure, download, and upload point data points in spreadsheet mode.

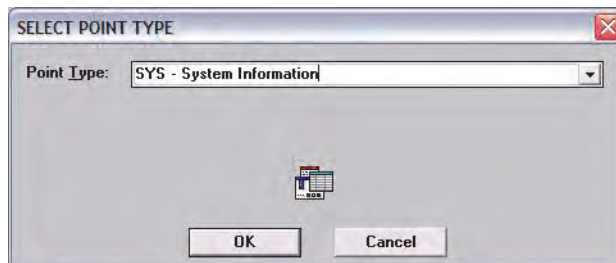

Figure 7-12: Spreadsheet Mode Edit Window

Password

The user can use the Password option to gain access to a protected file.

Once a password has been assigned, the user must enter the password when attempting to edit the 8130 RTU configuration file. This password is only entered once in the duration of the ViewRTU program.

To enter the password

1. Select Config and click Password.
2. Click the edit box in the Password dialog. Type in the password.
3. Click OK.



Figure 7-13: Configuration Password Dialog

Modify Password

The user can use the Modify Password function to protect all Tank Gauge Configuration files by issuing and changing a password.

Creating a Password

1. Select Config and click Password. The Change Password dialog appears.
2. In the New Password edit box, enter the password. If no password currently exists, leave the Old Password field blank.
3. In the Retype New Password edit box, confirm the entry by reentering the password.
4. Click OK.



Figure 7-14: Change Password Dialog

Note Make sure that you write down the password and store it in a secure place.

Changing the Password

1. Select Config and click Modify Change Password. The Change Password dialog appears, as illustrated in 'creating a password'.
2. In the Old Password edit box, enter the current password.
3. In the New Password edit box, enter the new password.
4. In the Retype New Password edit box, confirm the entry by reentering the new password.
5. Click OK.

Note Make sure that you write down the password and store it in a secure place.

The Communications Menu

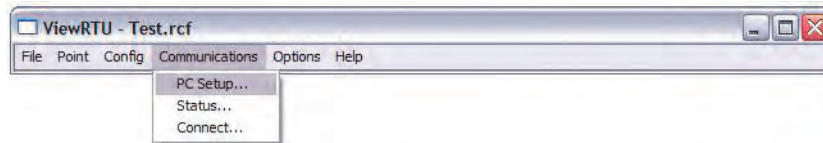

Figure 7-15: The Communications Menu

PC Setup

The PC Setup option allows the user to define the communications channel and data rate characteristics of the communications port. When selected, the following dialog box appears. This example dialog box contains the default settings for communications setup.

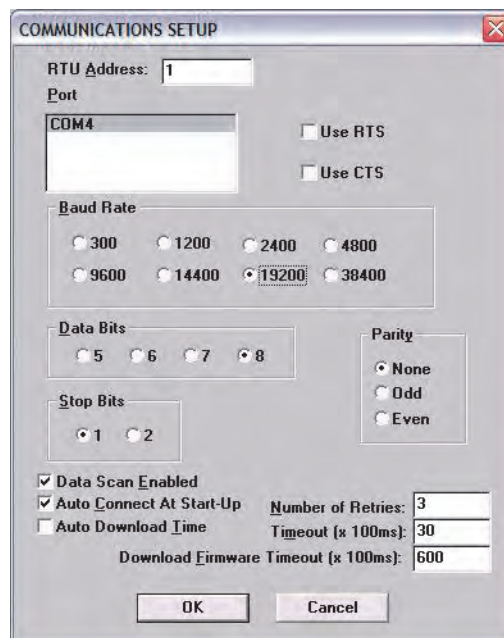

Figure 7-16: Port Communications Setup Dialog

Port Communications Setup dialog

This dialog box allows the user to enter the specifications of the 8130 RTU's communication port. When OK is selected, the setup data is stored as the default setup next time ViewRTU is executed.

Status

The Status option is provided so the user is able to observe communications data. The following dialog box appears when this option is selected.

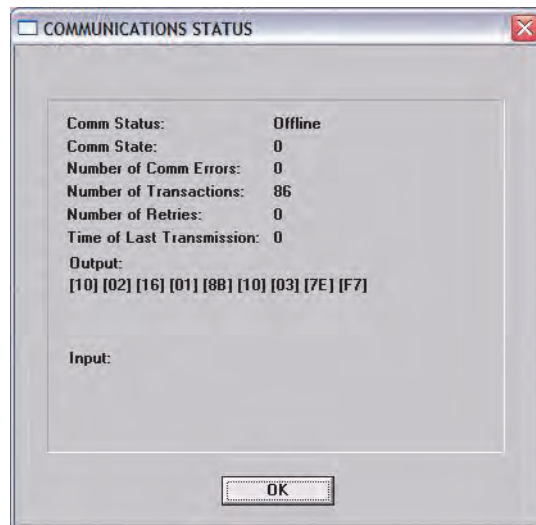

Figure 7-17: Communications Diagnostics Dialog

Connect

The Connect option is used when the user needs to search for a specific 8130 RTU. The following dialog box appears when the option is selected.

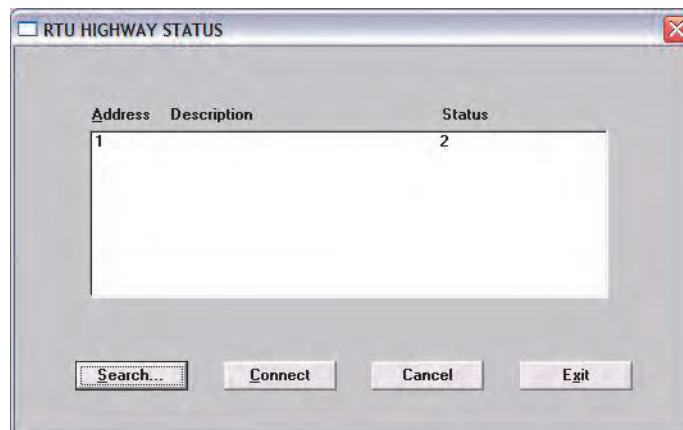

Figure 7-18: 8130 RTU Search Dialog

8130 RTU Search Dialog

This dialog box lists the address, description and current status of each 8130 RTU. From this dialog box the user can select an 8130 RTU and establish communications with the selected 8130 RTU.

The Options Menu

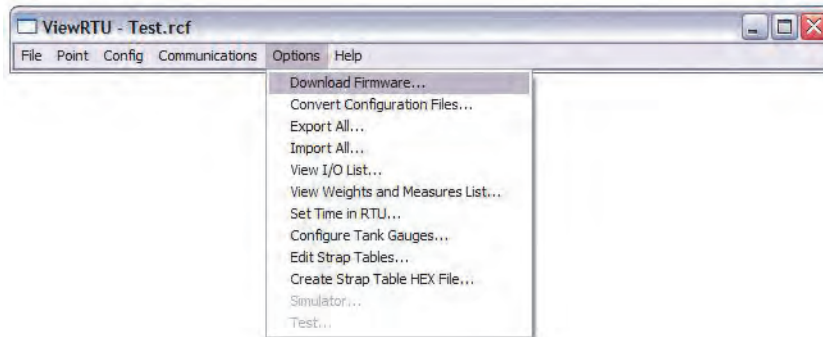

Figure 7-19: The Options Menu

Convert Configuration Files

The Convert Configuration Files option is used once the Download Firmware option has been executed. This option converts configuration files from one version to another. When selected, the following dialog box appears.

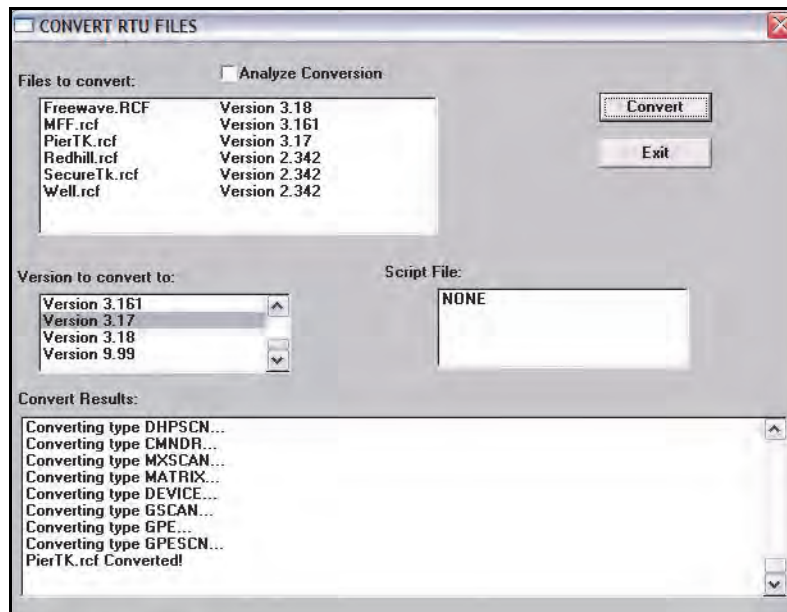

Figure 7-20: Convert ViewRTU Versions Dialog

Convert ViewRTU Versions Dialog

This dialog box allows the user to convert a file. The user has the option of first analyzing the effects of converting the file. A script file can also be selected to alter the behavior of the conversion. Script files are provided on the upgrade disk.

Export All

The Export All option allows the user to export all of the database in the 8130 RTU. Each point type is exported to a file in the CSV file format. For example, the Analog Input points are all exported to the file 'AI.CSV'. This means that the user can not specify each file name as the data is exported. The user does have the ability to specify the directory to export the data to. The user must create and then select the subdirectory for the export operation. We suggest that you organize the directories with names corresponding to the 8130 RTU address. If you have two 8130 RTU's, use the Windows File Manager program to create subdirectories \VIEWRTU\RTU1 and \VIEWRTU\RTU2. All of the files for 8130 RTU #1 should be written to \VIEWRTU\RTU1; 8130 RTU #2's data would go to \VIEWRTU\RTU2 and so on.

The exported data can be edited using a spreadsheet program such as Microsoft Excel, or a database program like Microsoft Access. Many programs can read and write data in the CSV file format. You can make backups of your RCF file by exporting the data in the CSV file format.

The exported data can be read back with the Import All option. The Spreadsheet Mode also has an option to import CSV file data.

Import All

The Import All option allows the user to import the entire 8130 RTU database. Each point type must have been exported previously in order to import data. This can be accomplished using the Export All option, or by point type using the Spreadsheet Mode. The data is read from files in the CSV file format. For example, all of the Analog Input points are imported from the file 'AI.CSV'. The user must select the subdirectory to import the data from.

The CSV file data can also be imported using the Spreadsheet mode.

View I/O List

The View I/O List option allows the user to create a list of the I/O points connected to the 8130 RTU. The list is limited by listing points that have the Chan or Module parameters. These parameters are always used in cases where I/O is involved. The list is created by writing to the file 'POINTLST.TXT' and launching the Notepad program. The user can print this file using Notepad, or exit and return to ViewRTU.

Set Time in 8130 RTU

The Set Time in 8130 RTU option sets the time in the CLK point to the same time as the PC running ViewRTU.

Configure Tank Gauges

The Configure Tank Gauges Option opens the Tank Gauge Configuration subsystem. See the Using Tank Gauge Configuration section for more information.

Edit Strap Tables

The Edit Strap Tables Option lets the user enter and modify strap table data. See the Application section of this chapter for more information on editing strap tables.

Create Strap Table HEX File

The Create Strap Table HEX File option saves the strap tables in a HEX format. HEX files can then be written to a PROM, for storage in the 8130 RTU. When you select Create Strap Table HEX File, the Save As dialog appears.

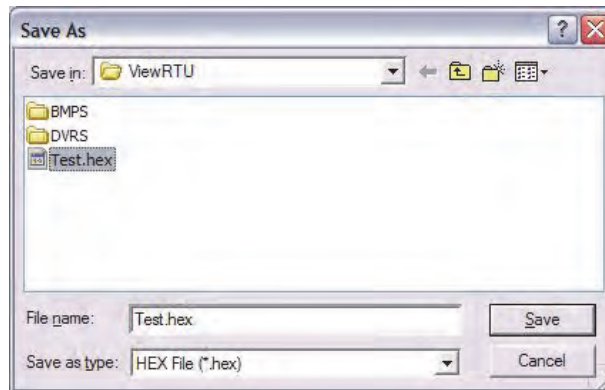

Figure 7-21: Save As (HEX) Dialog

Simulator

The Simulator option allows the user to write simulation scripts which will write data to the 8130 RTU database.

The Help Menu

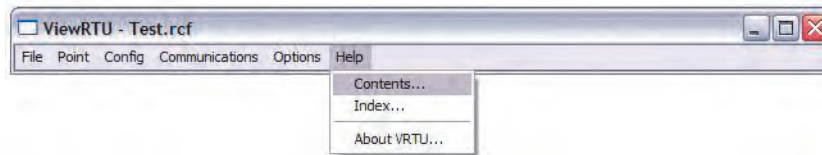

Figure 7-22: The Help Menu

Contents

The Contents option opens the table of contents of the ViewRTU on-line help.

Index

The Index option opens the index for the ViewRTU online system. This index lists all the help screens contained in the help system.

About V8130 RTU

The About 8130 RTU option displays a dialog box describing the copyright information and the application version number.

Using ViewRTU

By using ViewRTU, the user is able to define or modify sub-programs called Software Blocks. Software blocks are used to configure the 8130 RTU.

Note Refer to the 8130 RTU Software Blocks chapter for specific examples. The chapter provides a description of the parameters for each point as well as examples of the connections to other points.

8130 RTU software blocks are functions that the user can configure to perform various tasks. Software Blocks are available to scan data from a slave device, control a pump, serve data to other Host systems or perform calculations. Each function type contains both the code and data necessary to perform the function. Software Blocks are identified by their type (example: AI, DI, LJ2000 and PUMP). Points are individual instances of software blocks. Each point must be added and then configured. Adding a point makes the point available for configuration. All defined points appear in both the Point Icon Selection area and the Spreadsheet Summary in the main window.

Configuring the point involves entering configuration parameters. In some cases, connections to other points are required in order to perform a task. Creating connections involves setting references to allow data to be transferred between points.

Overview

An outline of the section is listed below:

Configuring Single Points

This section describes the method used to configure individual points including:

- Adding a Point
This section describes how to define a point from the Main window.
- Entering Point Data
This section describes how to enter the point's parameters. Parameters are entered from the Edit Point Window.
- Modifying Strap Tables
This section describes how to modify strap tables in ViewRTU.

Configuring Multiple Points

This section describes the spreadsheet mode. The principles involved in point configuration are the same, but the methods are slightly different.

- Adding Multiple Points
This section describes how to define a point from either the Main window or the Spreadsheet Mode window.
- Entering Point Data
This section describes how to enter a point's parameters. Parameters are entered from the Spreadsheet Mode window.

Creating and Editing Connections

This section describes how to create connections between various points. Points may be used to retrieve and/or deliver data from other points.

Configuring Single Points

Configuring the point involves entering configuration parameters. In some cases, connections between points must also be required in order to perform a function. All of these steps can be implemented from the Point Connections window. To display the Point Connections window, follow one of the methods listed below:

Adding a Point



The user is able to add a point or point type by clicking the Add Point icon from the toolbar or by selecting Add from the Point menu. Once the point is added, the user is then able to configure the point. Defined point types appear in the Point Icon Selection Area and in the Spreadsheet Summary of the main window.

Entering Point Data

This section describes how to configure the parameters of any point. Each point has its own Edit Point window that requires some degree of configuration. Both the configuration and dynamic attributes of the point are found in the Edit Point Window. From this window, the user is able to view and edit database parameters.

Several methods can be used to display this window depending on the user's current location in the program:

- If in the Main window, select Edit from the Point menu. Select the desired point type and corresponding point number.
- If in the main window, double-right click on the point icon.
- If in the Point Connections window, double-left click on the focus point icon.
- If in the Point Connections window, double-right click on a point icon other than the focus point icon.

The following example window appears.

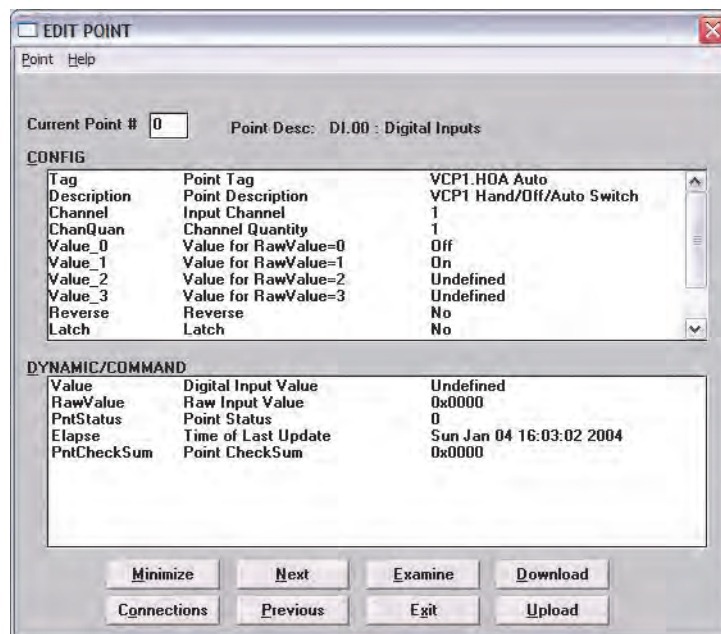

Figure 7-23: Edit (Digital) Point Dialog

Edit (Digital) Point Dialog

This window is used to view and modify the Dynamic and Configuration parameters of the selected point. The Edit Point window is identified by the Point Description and associated current Point Number listed at the top of the window.

This window contains two list boxes and a series of icons. The top list box contains the configuration parameters of the point, while the bottom list box contains Dynamic and Command parameters.

The first column contains the name of the parameter and the second column contains descriptions of the parameters. The third column of the Configuration parameters section contains the default data. The user can change a value by double-clicking an entry and entering the new variable. If a 8130 RTU is connected and on-line, the third column of the Dynamic parameters will update in real-time.

Edit Point Window Icons

The user is able to perform a series of functions from selecting the icons found in the bottom of the Edit Point window. Each icon is described below.

Minimize

The Minimize icon creates a “mini window” of selected parameters. This icon enables the user to observe relationships between dynamic parameters and how the changes affect the point.

Clicking the Minimize shrinks the window so that only one or more selected list box parameters are displayed. The user may have multiple minimize windows opened simultaneously. This capability is useful for testing and debugging.

Minimizing the Edit Point Window

1. Highlight by single-clicking the left mouse button on one or more parameters.
2. Click on the Minimize icon. A following example window appears:



Figure 7-24: Edit Point Dialog Minimized

Note Parameters can be edited in the minimized mode by double-clicking the right mouse button on the desired selection.



• To maximize the window, click on the maximize icon or click on the Application Control menu of the window and select the Maximize menu option.

Connections

The Connections icon allows the user to switch back to the Point Connections dialog box.

Next

The Next icon allows the user to step through the list of points. The user is able to view the Edit Point window of the following point number. Selecting Next at the end of the point number list wraps to the beginning.

Previous

The Previous icon allows the user to step through multiple points of a point type. The user is able to view the data in the Edit Point window of the previous point. Selecting Previous at the first point number wraps to the last point number of the list.

Examine

The Examine icon is used to go to the Point Connections window of the reference point in the list box.

Opening a point connection window

1. Highlight the desired reference data parameter from the Edit Point window.
2. Click the Examine button.

The user is taken to that reference point's Point Connections window.

Exit

The Exit icon exits the current point configuration and returns the user to the main menu.

Download

The Download icon allows the user to download the entire point data to the 8130 RTU.

Upload

The Upload icon allows the user to upload the entire point data from the 8130 RTU.

Modifying Values

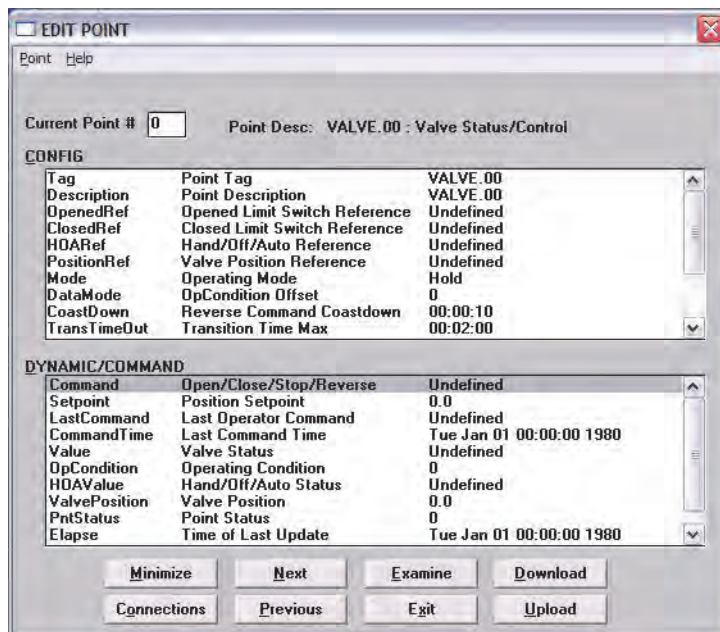

Figure 7-25: Edit Point Dialog (Adding a Value)

To modify a value

- Double-click the desired parameter to enter a new value. The following example Modify Point dialog box appears.

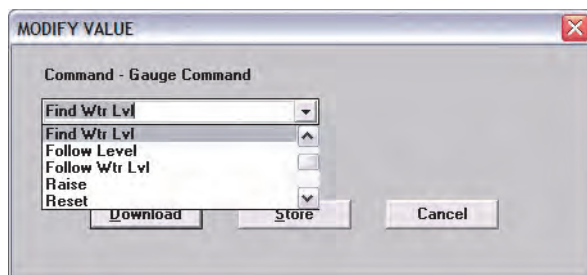

Figure 7-26: Edit Point Parameter Value Dialog

Edit Point Parameter Value Dialog

From this dialog box, the user is able to enter a value for the selected parameter. The dialog box varies according to the selected parameter. In some dialog boxes the user is able to enter the name or data directly in the edit box. Other dialogs contain a scroll list from which the user selects a value. The new value can then be downloaded to the 8130 RTU or stored locally if the 8130 RTU is offline.

Modifying a Reference

There are two ways to modify a reference. One method is performed from the Edit Point window, and the other method is performed from the Point Connections window. For convenience, both methods are listed below:

To modify a Reference

1. In the Edit Point Window double-click the desired reference parameter to enter a new value. The following dialog box appears.
2. In the Point Connections Window drag and drop the point icon onto the PntRef. The following dialog box appears.

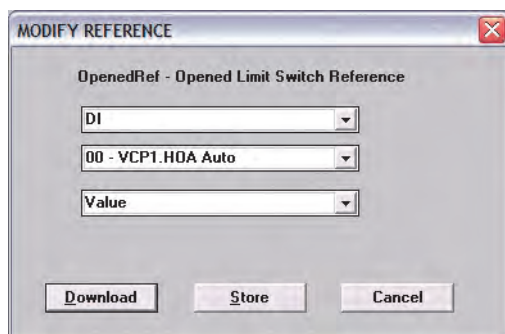

Figure 7-27: Edit Point Parameter Reference Dialog

Edit point parameter reference dialog

This dialog box is used to select a new point reference, corresponding point reference number, and/or parameter. If displayed from the Edit Point window, the selection lists the default value. If displayed from the Point Connections window, the most consistent value is selected as the default.

Only valid references appear in the list boxes contained in this dialog box. The new reference can then be downloaded to the 8130 RTU or stored locally if the 8130 RTU is off-line.

To Modify Strap Tables

To modify strapping tables in ViewRTU, the user will select Edit Strap Tables from the Options menu. The Modify Strap Tables dialog appears.

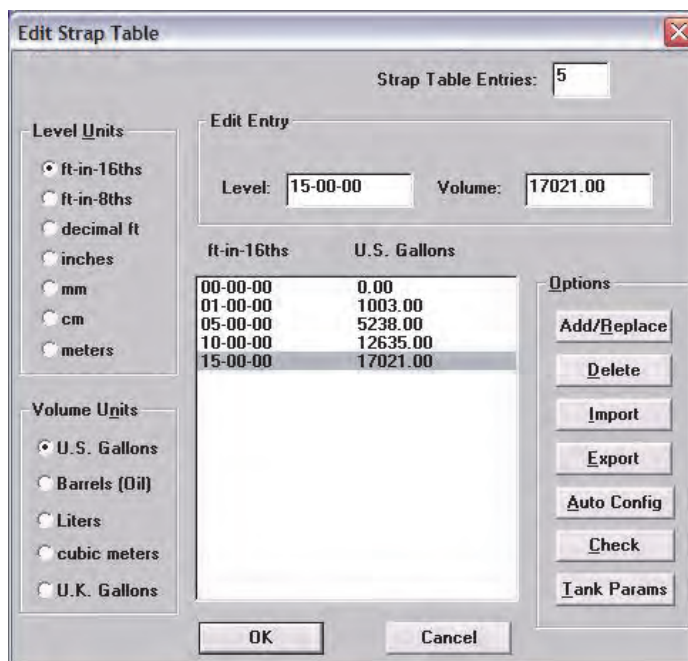

Figure 7-28: Edit Strap Table Dialog

Edit Strap Table Dialog

This dialog box allows you modify tank gauge strap tables.

Level Units

The user can convert the level units of the strap table by selecting one of the options in the Level Units list. The system asks you to confirm your selection.

Volume Units

The user can convert the volume units of the strap table by selecting one of the options in the Volume Units list. The system asks you to confirm your selection.

Add/Replace

The Add/Replace icon lets the user add a new strap table entry or replace an entry with modified data. To create a new entry, enter the table information in the Level and Volume fields and click Add/Replace. The system creates an entry with the information you entered. To change an existing entry, select the table entry from the list window and enter the new information in the Level and Volume fields. Then click Add/Replace. The system replaces the entry with the revised data.

Delete

The Delete icon allows the user delete strap table entries. Select the entry and click Delete. The system removes the strap table entry from the list box.

Import

The Import icon allows the user import a strap table from a file. The import file must exist in the correct format with a “.TST” or “.CSV” extension. The “.TST” files are used by FuelsManager.

To import a strap table

1. Click Import. The Open dialog appears.

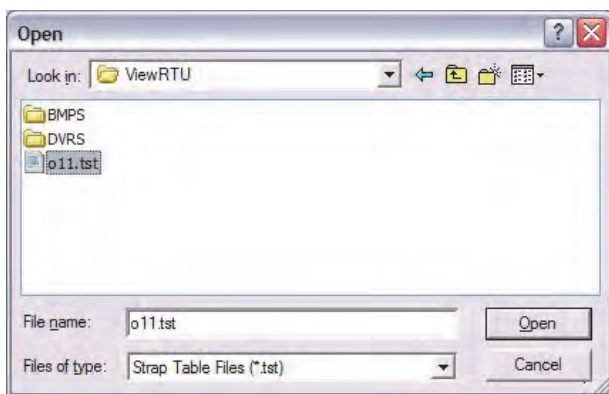

Figure 7-29: Open Dialog

2. Select or enter the file name and click OK. The system returns you to the Edit Strap Table dialog displaying the imported information.

Export

The Export icon allows the user export the strap table from the Edit Strap Table dialog to a file.

To export the strap table

1. Click Export. The Save As dialog appears.

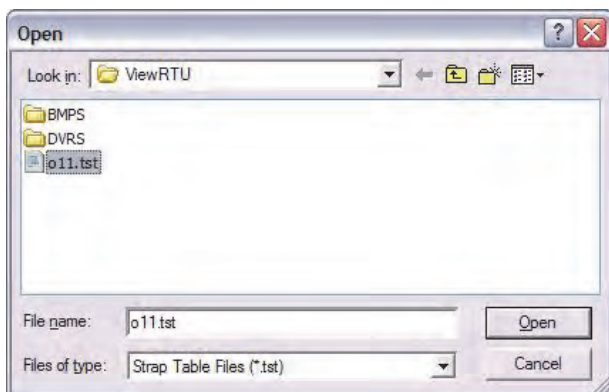

Figure 7-30: Save As Dialog

- Enter a file name and click OK. The file name must have a “.TST” or “.CSV” extension so you can import the file at another time. The system saves the file and returns you to the Edit Strap Table dialog.

Check

The Check icon allows the user confirm that the strap table has a valid data format. If the strap table is in the correct format, it displays the following check dialog.

If a problem exists in the strap table format, it displays the following check dialog and takes you to the entry that has the problem.

Configuring Multiple Points

The spreadsheet mode is one of the methods used to configure points. This method is the most beneficial when editing and viewing multiple points of the same type. Spreadsheets of each defined point are found in the Spreadsheet Summary section in the main window.

There are some differences between the regular and spreadsheet methods. First, the user is not able to view the Point Connections window in Spreadsheet Mode. This mode is used mainly for viewing and entering point data. Second, the spreadsheet focuses on points of a single type; it does not offer a “big picture” view of multiple point types.

Adding Multiple Points



The user is able to add a point by using the same method used to add single points. The user can click on the Add Point icon from the toolbar or by selecting Add from the Point menu in the Main window. Once the point is added, the user is then able to define the point. Defined points appear in the Point Icon Selection Area and in the Spreadsheet Summary of the Main window.

Note The user can add a point by selecting Add from the Point menu in the Spreadsheet Mode window. This menu is described later in the section.

Adding Multiple Points

- Double-click on the desired point type in the Spreadsheet Summary. The following example Spreadsheet Mode window appears.

SPREADSHEET MODE							
Point Edit Options							
D	U		Tag	Mode	LevelRef	TempRef	WaterRef
D	U	0	TANK.00	0	NMS53.00.Level	Al.00.Value	Al.01.Value
D	U	1	TANK.01	0	NMS53.01.Level	Al.02.Value	Al.09.Value
D	U	2	TANK.02	0	NMS53.02.Level	Al.03.Value	Al.10.Value
D	U	3	TANK.03	0	NMS53.03.Level	Al.04.Value	Al.11.Value
D	U	4	TANK.04	0	NMS53.04.Level	Al.05.Value	Al.12.Value
D	U	5	TANK.05	0	NMS53.05.Level	Al.06.Value	Al.13.Value
D	U	6	TANK.06	0	NMS53.06.Level	Al.07.Value	Al.14.Value
D	U	7	TANK.07	0	NMS53.07.Level	Al.08.Value	Al.15.Value

Figure 7-31: Spreadsheet Mode Window

Note Refer to the following Entering Point Data section for a description of the Spreadsheet Mode window.

Entering Point Data

This section explains the window used to configure multiple points of a single point type. When the user double-clicks on a point type, the following example dialog box appears:

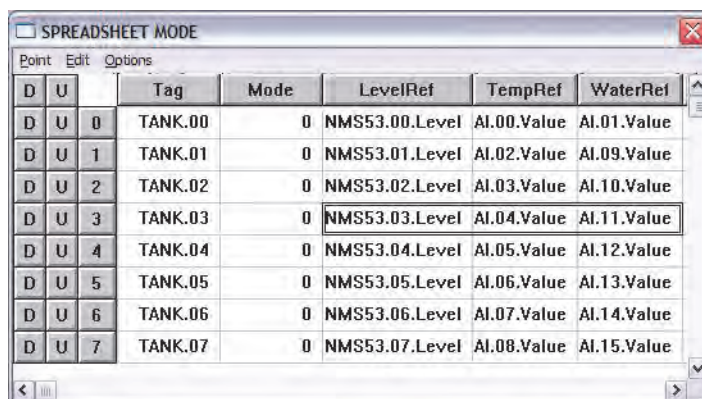

The screenshot shows a window titled 'SPREADSHEET MODE' with a menu bar containing 'Point', 'Edit', and 'Options'. Below the menu bar is a table with the following data:

D	U		Tag	Mode	LevelRef	TempRef	WaterRef
D	U	0	TANK.00	0	NMS53.00.Level	Al.00.Value	Al.01.Value
D	U	1	TANK.01	0	NMS53.01.Level	Al.02.Value	Al.09.Value
D	U	2	TANK.02	0	NMS53.02.Level	Al.03.Value	Al.10.Value
D	U	3	TANK.03	0	NMS53.03.Level	Al.04.Value	Al.11.Value
D	U	4	TANK.04	0	NMS53.04.Level	Al.05.Value	Al.12.Value
D	U	5	TANK.05	0	NMS53.05.Level	Al.06.Value	Al.13.Value
D	U	6	TANK.06	0	NMS53.06.Level	Al.07.Value	Al.14.Value
D	U	7	TANK.07	0	NMS53.07.Level	Al.08.Value	Al.15.Value

Figure 7-32: Spreadsheet Mode: Entering Point Parameter Data

Spreadsheet Mode

This window displays a list of all the point numbers of a selected point type. The user is able to add, configure, and edit points. The user is able to select and enter the parameters for each point or group of points. The user can also export/import files and control the selection of displayed parameters.

Compare this window to the Edit Point window (see Figure 6-7 on page 6.8). The two windows contain the same parameters. In the spreadsheet mode, the user is able to view and modify all the points of the selected type. In the Edit Point window, the user steps through a window for each point number using the Next and Previous icons.

The left two columns, D and U are used to download and upload, respectively, the information found in the corresponding row(s). The third column lists the point numbers. The Spreadsheet Mode menu bar contains menus used to perform various functions to one or more points. Each of the Spreadsheet Mode menus is described below.

The Point Menu

This menu contains the same menu options found in the main window's menu bar. Refer to The Point Menu section for a description of the menu options.

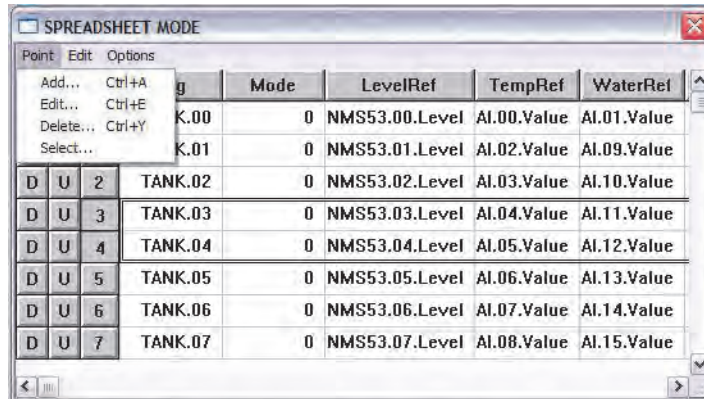

Figure 7-33: Spreadsheet Mode: The Point Menu

This option is useful for creating, deleting and editing points without having to exit out of the Spreadsheet mode.

The Edit Menu

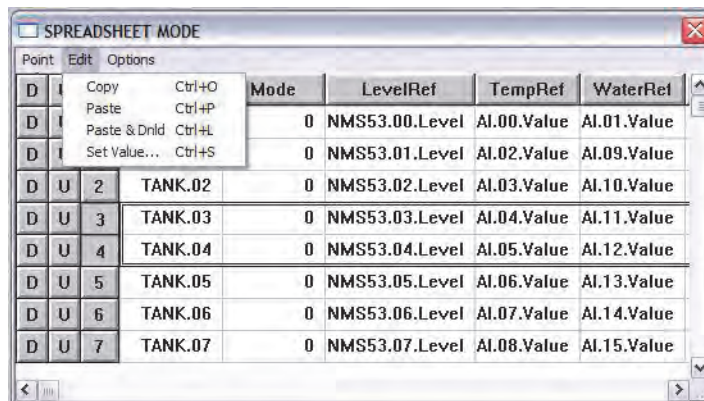

Figure 7-34: Spreadsheet Mode: The Edit Menu

Copy

The Copy option allows the user to copy data from a one or more selected cells.

1. Select one or more cells to copy. To select one or more rows, click on the number(s). To select one or more columns, click on the parameter(s).
2. Select the Copy option from the Edit menu. The selected cells outline changes from black to red.

Note To undo the Copy option, press the Esc key. Pressing the Esc key removes the selection outline from the selected cells.

Paste

The Paste option allows the user to paste the copied group of cells (red outline) to the currently selected group of cells (black outline).

1. Select the cells on which the copied cells will be pasted.
2. Select the Paste option from the Edit menu.

D	U	Tag	Description	Channel	ChanQuan	
D	U	0	VCP1.HOA Auto	VCP1 Hand/Off/Auto Switch	1	1
D	U	1	VCP1.HOA Hand	VCP1 Hand/Off/Auto Switch	2	1
D	U	2	VCP1. Closed St	VCP1 Valve Status	3	1
D	U	3	VCP1. Open Stat	VCP1 Valve Status	4	1
D	U	4	VCP2.HOA Auto	VCP2 Hand/Off/Auto Switch	5	1
D	U	5	VCP2.HOA Hand	VCP2 Hand/Off/Auto Switch	6	1
D	U	6	VCP2. Closed St	VCP2 Valve Status	7	1
D	U	7	VCP2. Open Stat	VCP2 Valve Status	8	1
D	U	8	VCP2. Closed St	VCP2 Valve Status	7	1
D	U	9	VCP2. Open Stat	VCP2 Valve Status	8	1
D	U	10	DI.10	DI.10	11	1

Figure 7-35: Spreadsheet Mode: Copying and Pasting Point Parameter Data Rows

Note If the number of rows and columns in both selections do not match, the extra copied cells are truncated. Incompatible cells containing different data types are not copied; instead a warning is displayed.

Paste & Dnld

The Paste & Dnld option is very similar to the Paste menu selection. The only difference is that the Paste & Dnld selection downloads the updated data parameters.

Set Value

The Set Value option allows the user to enter or select a value for a parameter.

1. Click on the desired cell or column.
2. Select Set Value from the Edit menu. The Modify Value dialog box appears:

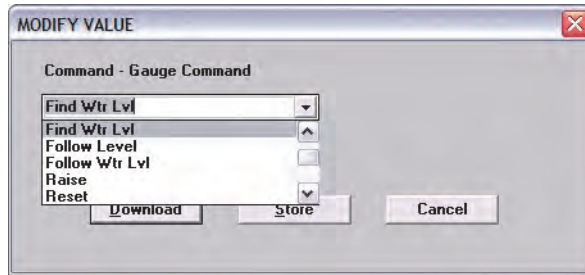

Figure 7-36: Spreadsheet Mode: Editing Point Parameter Values

3. Enter or select a value from the scroll list.

Set Value (with Auto Increment)

This option can also be used for numeric parameters such as channels to auto increment the value. Follow the procedure below:

1. Click each desired cell or column.
2. Select Set Value from the Edit menu. The following dialog box appears:

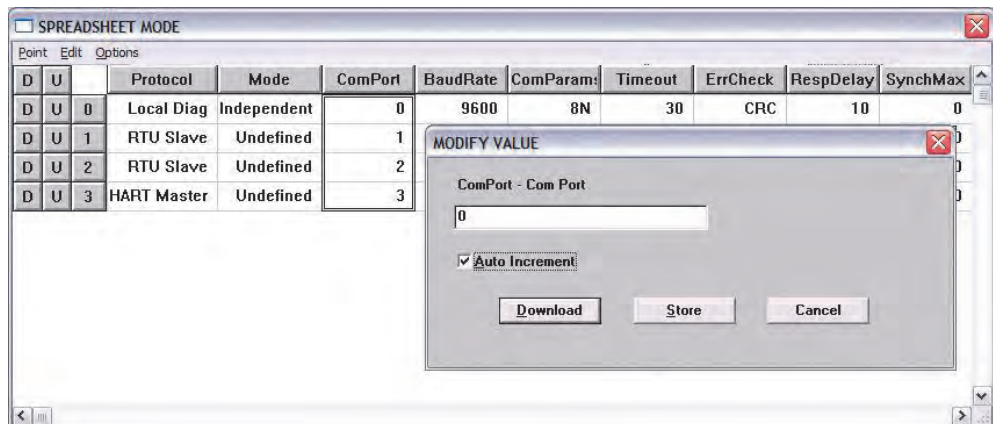

Figure 7-37: Spreadsheet Mode: Editing Point Parameter Values using Auto Increment

Each value in the column is incremented by one for the range of rows selected. All cells that are selected and match the data type of the value are set to the value.

The Options Menu

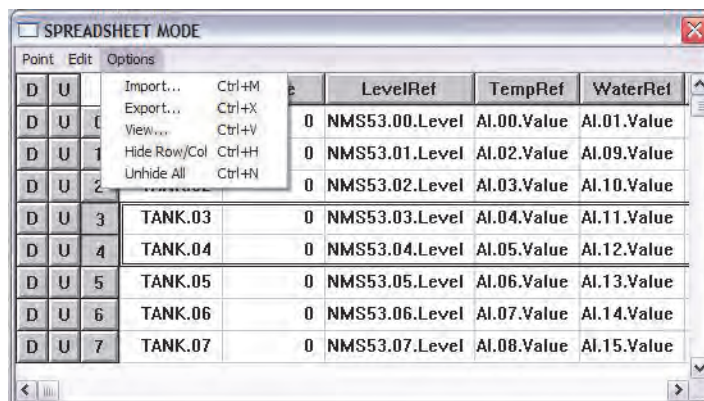

Figure 7-38: Spreadsheet Mode: The Options Menu

Import

The Import option allows the user to import a point or group of points that match the current point type. The imported file is named according to the point type with the 'CSV' file extension.

Export

The Export option allows the user to export a selected point or all the points that match the current point type to the default directory. The export file is saved in a file named according to the point type with the 'CSV' file extension

Note The user is able to change the source directory in the INI file.

View

The View option allows the user to display selected parameter types. Selecting this option displays the following View Point Parameters dialog box.

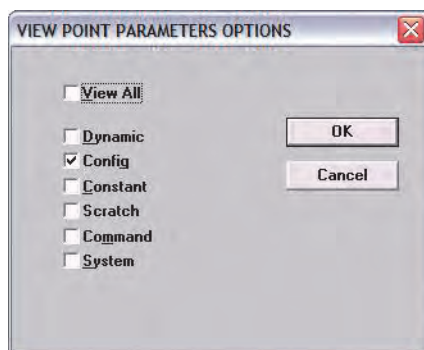

Figure 7-39: Spreadsheet Mode: Viewing Selected Parameter Types Dialog

The user is able to select any combination of parameter types. The user is able to select any combination of classifications. The classifications are described briefly below.

Parameter Type	Description
Dynamic	Real-time data such as status
Config	General specifications such as tag and description
Constant	Data that does not change and/or can not be changed
Scratch	Temporary data that is typically hidden from the user
Command	Output command data
System	System data (should not be changed by the user)

Note The default View setting is the Config parameter type.

Hide Row/Col

The Hide Row/Col option allows the user to hide selected rows or columns.

Note The Copy and Paste operations do not affect hidden rows and columns.

1. Select one or more rows or columns.
2. Select the Hide Row/Col option from the Options menu.

The selected rows or columns are indicated by a '+' in the row or column buttons heading. The following dialog box illustrates this feature.

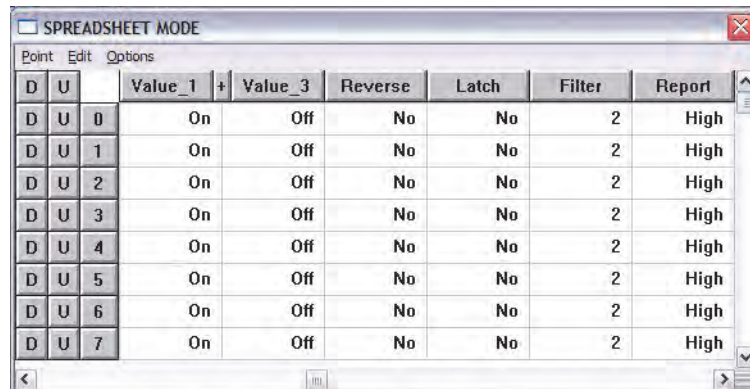

Figure 7-40: Spreadsheet Mode: Hiding Columns

The user can unhide a row or column by clicking the associated '+'. To unhide all the rows/columns, the user can select the Unhide All option from the Options menu.

Unhide All

The Unhide All option allows the user to reveal all of the rows or columns that are currently hidden.

Creating and Editing Connections

Several methods can be used to display this window depending on the user's current location in the program. These methods are listed below:

- If in the Main window, double-left click the point icon.

- If in the Edit Point window, click the Connections icon.
- If in the Point Connections window, double-left click a point icon other than the focus point to view the Point Connections window for the selected point.

Note If multiple points exist, a selection window is displayed showing all the available points.

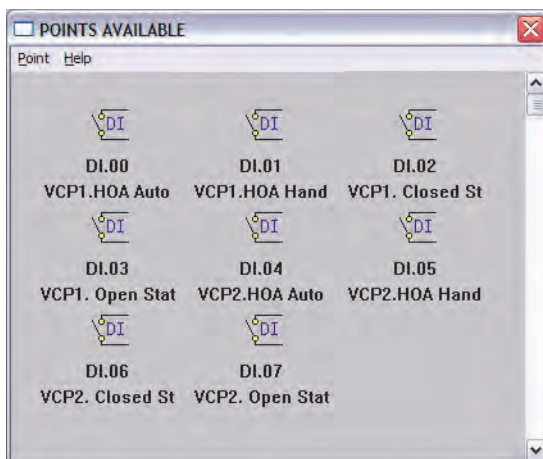

Figure 7-41: Edit Point Selection Window

Displaying the Point Connections window.

- Double-click one of the icons to display the Point Connections window. The following example Point Connections window appears.

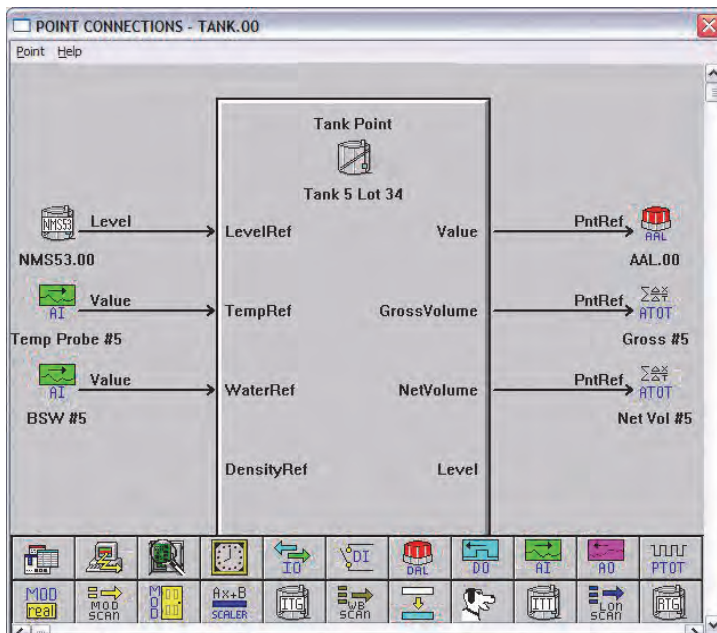

Figure 7-42: Point Connections Window

Point Connections Window

This graphic display visually illustrates the reference connections of the focus point. From this display, the user is able to select reference points, create connections between these points, and enter configuration parameters.

The point icons located in the Icon Bar utilize the drag-and-drop features of Windows. The user is able to connect the output data of one point to the input of another point.

The connections are made through point references and links. Not all points have references, but any parameter of a point can be referenced. Some references are incompatible with some types of data. The program can determine if a reference is valid, but it cannot determine if the reference is meaningful.

The Input Data parameters, which are located on the left side of the software block, are references. The Output Data parameters, which are located on the right side, are most commonly referenced by other points.

To create a Connection:

1. Select the desired point icon from the Icon Bar and drag it onto the desired data parameter.

If the point dropped does not exist, then the user needs to define the point as described in the previous section. The same configuration process is used to define the point.

If multiple points exist, the user is prompted to select the point number.

If the point dropped already contains a reference to another input reference, a dialog box appears inquiring whether or not to overwrite the existing reference.

2. The point icon appears to the right or left of the selected arrow.

Note Double-left clicking a focus point icon allows the user to view the point's Edit Point window.

Note Double-left clicking the input source or the output destination icon allows the user to step through each corresponding Point Connections window, if applicable.

Note Double-right clicking the input source or the output destination icon allows the user to view the point's Edit Point window.

8 Using Tank Gauge Configurator

This chapter describes how to configure tank gauges using the Tank Gauge Configurator. This chapter describes each of the menu items and gives user applications.

The Tank Gauge Configurator runs as a subsystem of ViewRTU. You can use the Tank Gauge Configurator to configure and control tank settings from a workstation.

Like ViewRTU, the Tank Gauge Configurator follows Windows standards, so the user that is familiar with Windows will be able to learn the program quickly. ViewRTU supports the Windows standard of selecting commands from a series of pull-down menus. If the user is not familiar with Windows-based programs, refer to the Microsoft Windows manual for basic instruction.

Executing the Tank Gauge Configurator

This section describes how to start up the Tank Gauge Configurator from the ViewRTU program. The components of the window are also described in this section. To execute the Tank Gauge Configurator program, follow the steps below.

Execute the Tank Gauge Configurator program

If needed, double-click on the ViewRTU icon to execute ViewRTU. If more than one 8130 RTU definition file (DVR) exists, the system prompts you to select which file to use. See the Using ViewRTU section for more information on opening ViewRTU.

- If needed, select a DVR file and click OK. The ViewRTU window appears.
- Click Options and select Configure Tank Gauges. If more than one Tank Definition File (TDF) file exists, the system prompts you to select which one you want to use.
- If needed, select a TDF file and click OK. The Tank Gauge Configurator window appears.

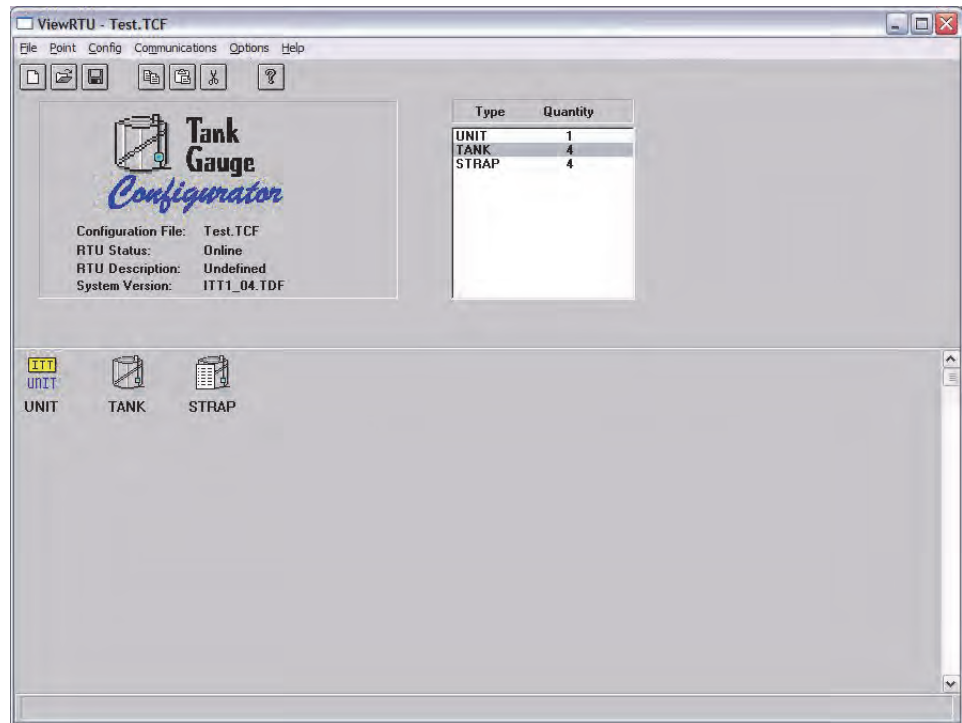

Figure 8-1: Main Tank Gauge Configurator Window with Descriptions

ViewRTU window

This main window allows the user to perform the commands necessary to configure the Tank Gauge. It contains Windows components such as the Application Control menu, title bar and menu bar.

The System Status Area

The System Status area displays the system version as well as general information about the configuration file. The Tank Gauge file name is found in both the System Status area and the title bar.

The Toolbar

The Toolbar contains several button icons used to execute frequently used commands found in the menu bar. In the menu description below, each appears next to its associated menu option.

The Spreadsheet Summary

The Spreadsheet Summary lists all the tank gauge configuration point types and corresponding number defined in the file. You can use this summary as a quick method for creating and editing the contents of each point by double-clicking on the desired point type. The parameters listed in the Spreadsheet summary directly correlate with each defined point.

Point Icon Selection Area

All the tank gauge configuration point icons are displayed in the Point Icon Selection Area. Point icons are visual representations of the tank gauge configuration point settings.

The Tank Gauge Configurator Menu Bar

This section describes all the menus found in the Tank Gauge Configurator menu bar. The button icons found in the Toolbar are shown next to each associated menu option. This section primarily describes the functionality of each menu option.

The File Menu

The File menu allows the user to create, open, and save configuration files. This menu also allows the user to save the current configuration to a different file name.



Figure 8-2: File Menu

New



The user is able to create a new configuration file by clicking on the New button from the toolbar or by selecting New from the File menu. When selected, a dialog box appears displaying a list of configuration definition files. The user selects the desired file from this list.

Open



The user is able to select an existing configuration file by clicking on the Open button from the toolbar, or by selecting Open from the File menu. When selected, a dialog box appears displaying a list of configuration files. All Tank Gauge configuration files are identified by the TCF extension. Once a file is selected, the point configuration data of the selected file is displayed. If the directory is empty, the user has the option of creating a new file by typing in the file name.

Save



The user is able to save the opened configuration file by clicking on the Save button from the toolbar, or by selecting Save from the File menu. The user can save the file any time the configuration has changed. If the file exists in the directory, the configuration is stored to disk using the current file name. If the file has not been saved before or the name does not exist in the directory, the user is prompted to enter a configuration file name.

Save As

The Save As option is used to save the currently opened file under a different name. When selected, a dialog box appears prompting the user to enter a file name. If the selected file name already exists, the user has the option of overwriting the file. Otherwise, the user can create a separate file containing all the current configuration data of the present file. If the user chooses to create a separate file, the current file is automatically closed. Only one file may be open at a time.

Exit

The Exit option is used to close the ViewRTU application. If the current configuration file has not been saved, the user is prompted to save the file or cancel the option.

The Point Menu

Figure 8-3: Point Menu

Edit

The user is able to edit an existing point by clicking on the Edit button from the toolbar or by selecting Edit Point from the Point menu. This option is used to modify the contents of a selected point. When selected, the following dialog box appears:

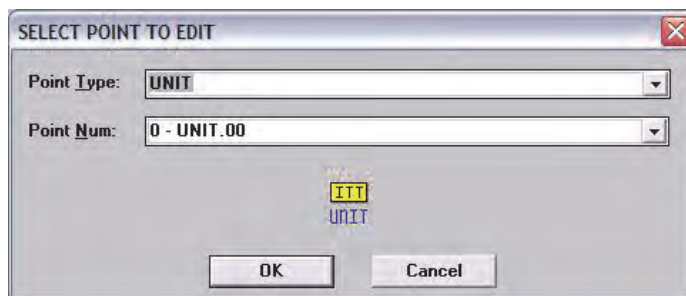

Figure 8-4: Edit Point Selection Dialog

This dialog box displays a list of defined point types and corresponding point numbers. The point icon is also displayed for identification as well as the tag, if a tag has been assigned.

Once a point is selected, the Edit Point dialog box appears:

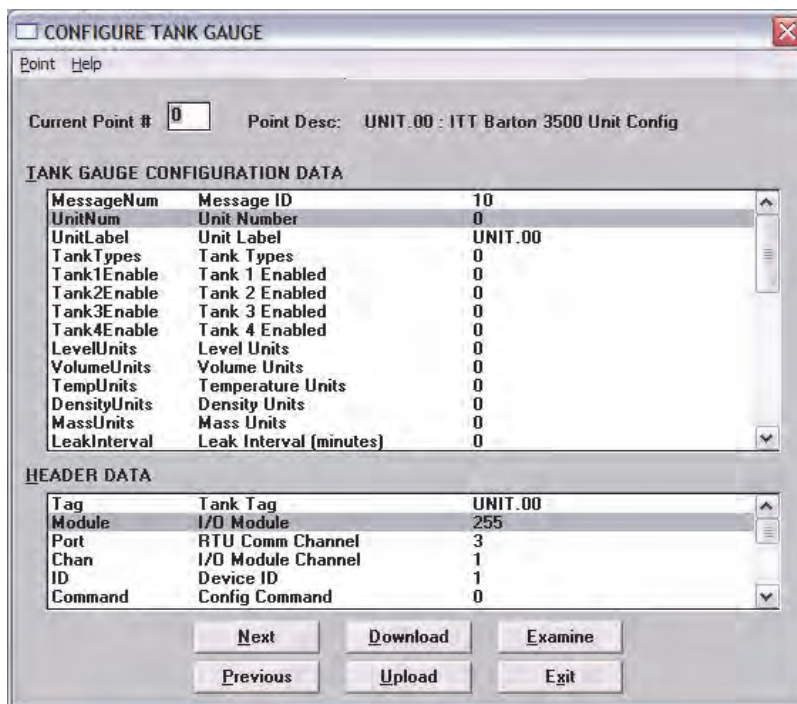

Figure 8-5: Edit Point Dialog

Edit Point Dialog

This dialog box contains all dynamic and configurable field information. The user is able to edit point data. Exiting this dialog box returns the user to the main window.

Note Several other methods can be used to display the Edit Point dialog box. These methods and other information are explained in greater detail in the Application section.

The Config Menu



Figure 8-6: Configuration Menu

Download All

The Download option is used to download all the configuration data to the tank gauge. The following dialog box is displayed:

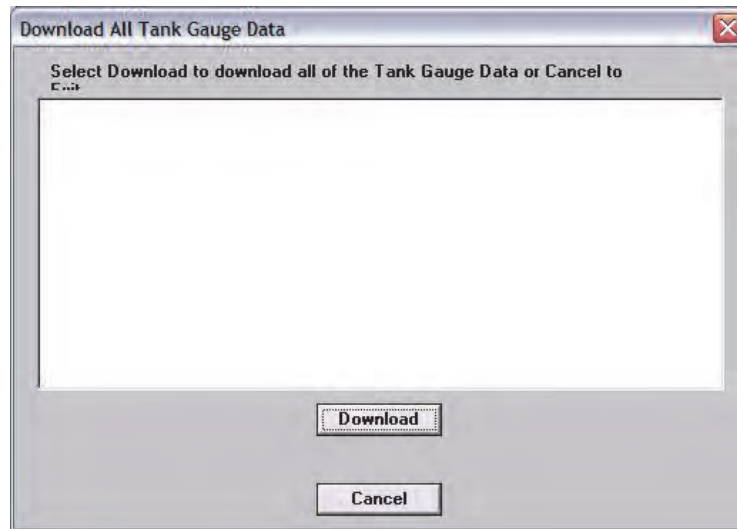

Figure 8-7: Dialog used to Download 8130 RTU Data

To download all the data to the tank gauge, the user selects the Download button. The system transmits all the tank gauge configuration data to the tank gauge.

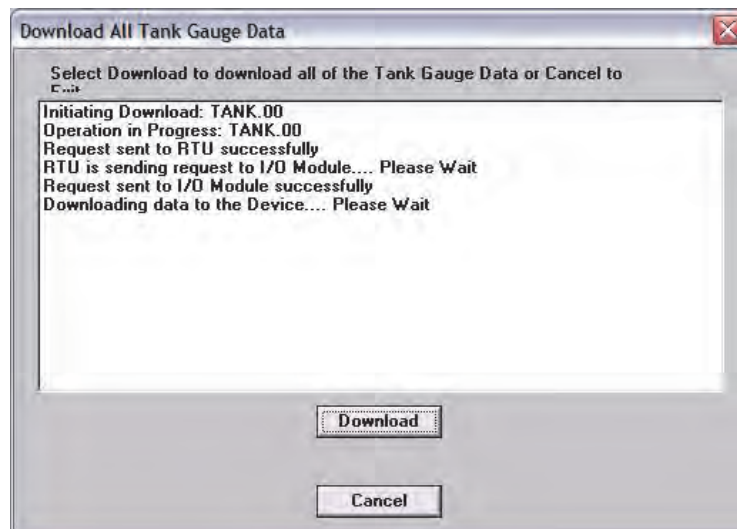

Figure 8-8: Download Tank Gauge Data Dialog Showing Finished Download

Password

The user can use the Password option to gain access to a protected file.

Once a password has been assigned, the user must enter the password when attempting to edit the 8130 RTU configuration file. This password is only entered once in the duration of the Tank Gauge Configurator program.

To enter the password

1. Select Config and click on Password.

2. Click on the edit box in the Password dialog. Type in the password.
3. Click on OK.



Figure 8-9: Configuration Password Dialog

Change Password

The user can use the Change Password function to protect all Tank Gauge Configuration files by issuing and changing a password.

To create a password

1. Select Config and click on Password. The Change Password dialog appears.
2. In the New Password edit box, enter the password. If no password currently exists, leave the Old Password field blank.
3. In the Retype New Password edit box, confirm the entry by reentering the password.
4. Click on OK.



Figure 8-10: Change Password Dialog

Note Make sure that you write down the password and store it in a secure place.

To change the password

1. Select Config and click on Modify Change Password. The Change Password dialog appears, as illustrated in 'creating a password'.
2. In the Old Password edit box, enter the current password.
3. In the New Password edit box, enter the new password.
4. In the Retype New Password edit box, confirm the entry by reentering the new password.
5. Click on OK.

Note Make sure that you write down the password and store it in a secure place.

The Communications Menu



Figure 8-11: Communications Menu

Setup

The Setup option allows the user to define the communications channel and data rate characteristics of the communications port. When selected, the following dialog box appears. This example dialog box contains the default settings for communications setup.

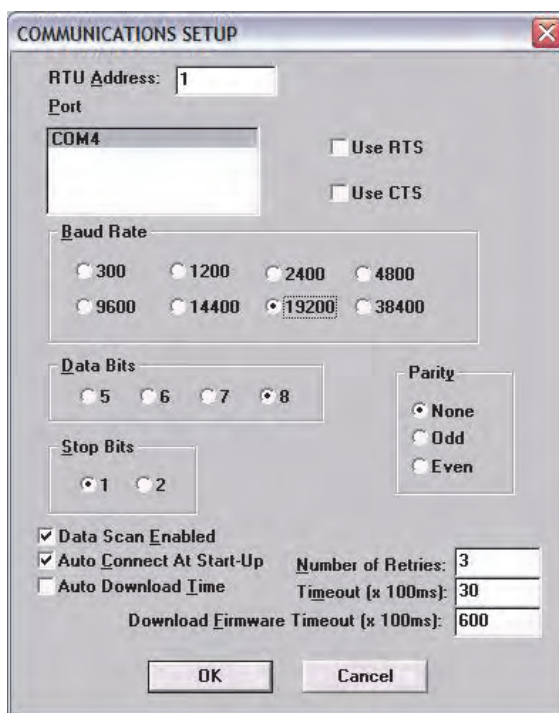

Figure 8-12: Port Communications Setup Dialog

Port Communications Setup Dialog

This dialog box allows the user to enter the specifications of the 8130 RTU's communication port. When OK is selected, the setup data is stored as the default setup next time ViewRTU or Tank Gauge Configuration is executed.

Status

The Status option is provided so the user is able to observe communications data. The following dialog box appears when this option is selected.

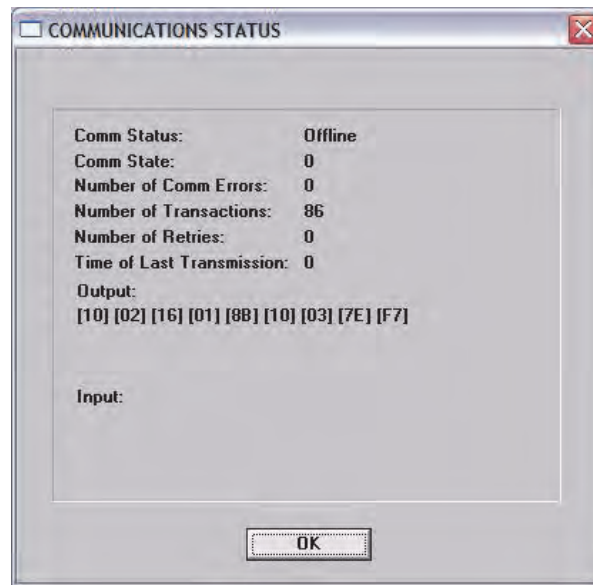

Figure 8-13: Communications Diagnostics Dialog

Connect

The Connect option is used when the user needs to search for a specific 8130 RTU. The following dialog box appears when the option is selected.

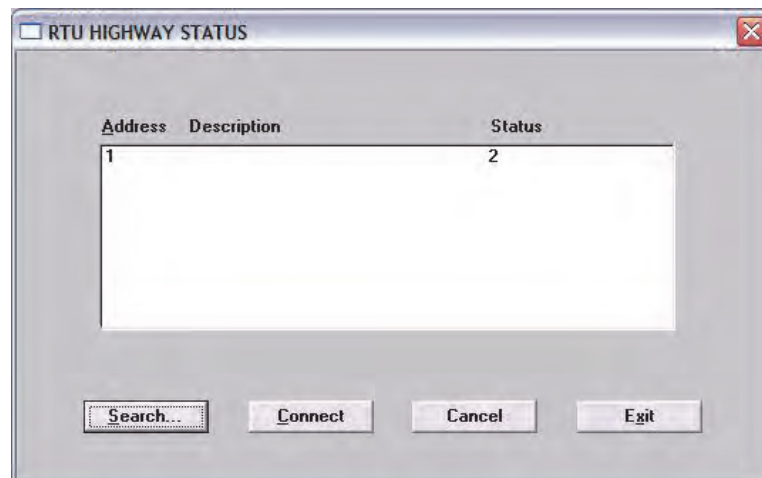

Figure 8-14: 8130 RTU Search Dialog

8130 RTU Search Dialog

This dialog box lists the address, description and current status of each 8130 RTU. From this dialog box the user can select an 8130 RTU and establish communications with the selected 8130 RTU.

The Options Menu



Figure 8-15: Options Menu

Export All

The Export All option allows the user to export the entire tank gauge Configurator database. Each point type is exported to a file in the CSV file format. The user must create and then select the subdirectory for the export operation.

The exported data can be edited using a spreadsheet program such as Microsoft Excel, or a database program like Microsoft Access. Many programs can read and write data in the CSV file format. You can make backups of your TCF file by exporting the data in the CSV file format.

The exported data can be read back with the Import All option. The Spreadsheet Mode also has an option to import CSV file data.

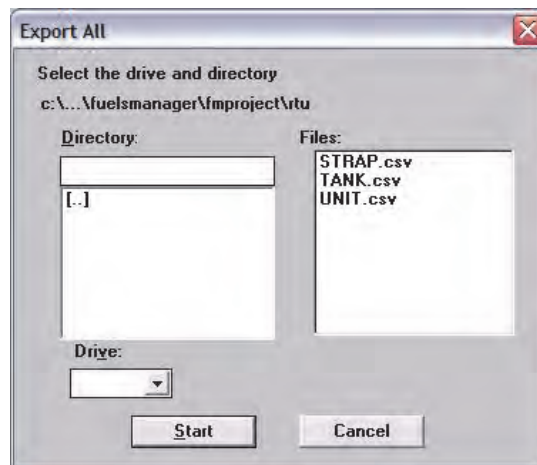

Figure 8-16: Download 8130 RTU Firmware Dialog

Import All

The Import All option allows the user to import all of the Tank Gauge's database information from a file. Each point type must have been exported previously in order to import data. This can be accomplished using the Export All option, or by point type using the Spreadsheet Mode.

The data is read from files in the CSV file format. For example, all of the Unit points are imported from the file 'UNIT.CSV'. The user must select the subdirectory to import the data from. The CSV file data can also be imported using the Spreadsheet mode.

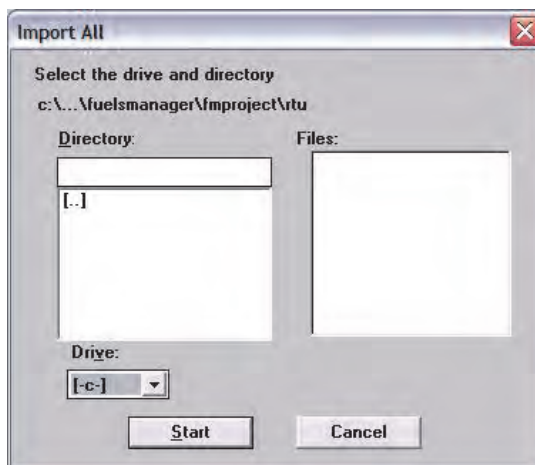

Figure 8-17: Convert ViewRTU Versions Dialog

Note The Tank Gauge Configurator does not export strap tables to these CSV files. Use the Strap Table Export feature to save strap tables in CSV file format.

Exit Tank Gauge Configurator

The Exit Tank Gauge Configurator option allows the user to exit the Tank Gauge Configurator and return to the ViewRTU application.

The Help Menu

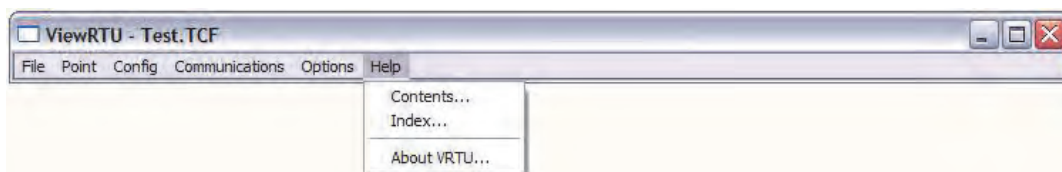

Figure 8-18: Help Menu

Contents

The Contents option allows the user to access the windows on-line help file table of contents.

Index

The Index option allows the user to search or browse through topics in the help file.

About 8130 RTU

The About 8130 RTU option displays a dialog box describing the copyright information and the application version number.

Using Tank Gauge Configurator

The Configuring Tank Gauge Configurator Point section describes the method used to configure individual points, including:

- Adding a Tank Gauge Configurator Point
- Entering Tank Gauge Configurator Point Data

The Configuring Multiple Tank Gauge Configurator Points describes the spreadsheet, including:

- Adding Multiple Tank Gauge Configurator Points
- Entering Tank Gauge Configurator Point Data

The principles involved in point configuration are the same, but the methods are slightly different.

Configuring Tank Gauge Configurator Points

Configuring a tank gauge configurator point involves entering configuration parameters.

Adding a Tank Gauge Configurator Point

The user is able to add a point or point type by clicking on the Add Point button from the toolbar or by selecting Add from the Point menu.

Once the point is added, the user is then able to configure the point. Defined point types appear in the Point Icon Selection Area and in the Spreadsheet Summary of the main window.

In most cases there is no need to add additional points.

Entering Tank Gauge Configurator Point Data

This section describes how to configure the parameters of any tank gauge Configurator point. Each point has its own Edit Point window that requires some degree of configuration. Both the configuration and dynamic attributes of the point are found in the Edit Point Window. From this window, the user is able to view and edit database parameters.

Several methods can be used to display this window depending on the user's current location in the program:

- If in the Main window, select Edit from the Point menu. Select the desired point type and corresponding point number.
- If in the main window, double-right click on the point icon.

The following example window appears.

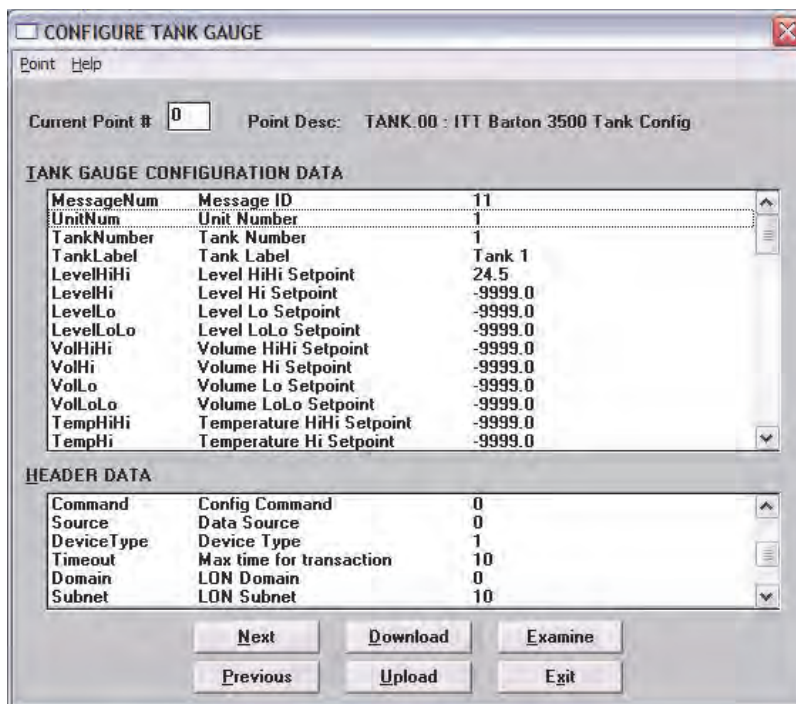

Figure 8-19: Edit (Digital) Point Dialog

Edit Point Dialog

This window is used to view and modify the tank gauge configuration and header parameters of the selected point. The Edit Point window is identified by the Point Description and associated current Point Number listed at the top of the window.

This window contains two list boxes and a series of buttons. The top list box contains the configuration parameters of the point, while the bottom list box contains header parameters.

The first column contains the name of the parameter and the second column contains descriptions of the parameters. The third column of the Configuration parameters section contains the default data. The user enters these values.

Edit Point Window Buttons

The user is able to perform a series of functions from selecting the buttons found in the bottom of the Edit Point window. Each button is described in the table below.

Button	Function
Next	The Next button allows the user to step through the list of points. The user is able to view the Edit Point window of the following point number. Selecting Next at the end of the point number list wraps to the beginning.
Previous	The Previous button allows the user to step through multiple points of a point type. The user is able to view the data in the Edit Point window of the previous point. Selecting Previous at the first point number wraps to the last point number of the list.
Download	The Download button allows the user to download the entire point data to the tank gauge.
Upload	The Upload button allows the user to upload the entire point data to the tank gauge.

Button	Function
Examine	The Examine button is used to open files that are either uploaded to the tank gauge, or downloaded from the tank gauge. Opening a Edit Point window: <ul style="list-style-type: none"> Highlight the file parameter from the Edit Point window. Click on the Examine button. The system opens the Windows Notepad and displays the file.
Exit	The Exit button exits the current point configuration and returns the user to the main menu.

To modify a value

- In the Configure Tank Gauge window double-click the desired parameter to open the parameter for modification. The following window Modify value appears.

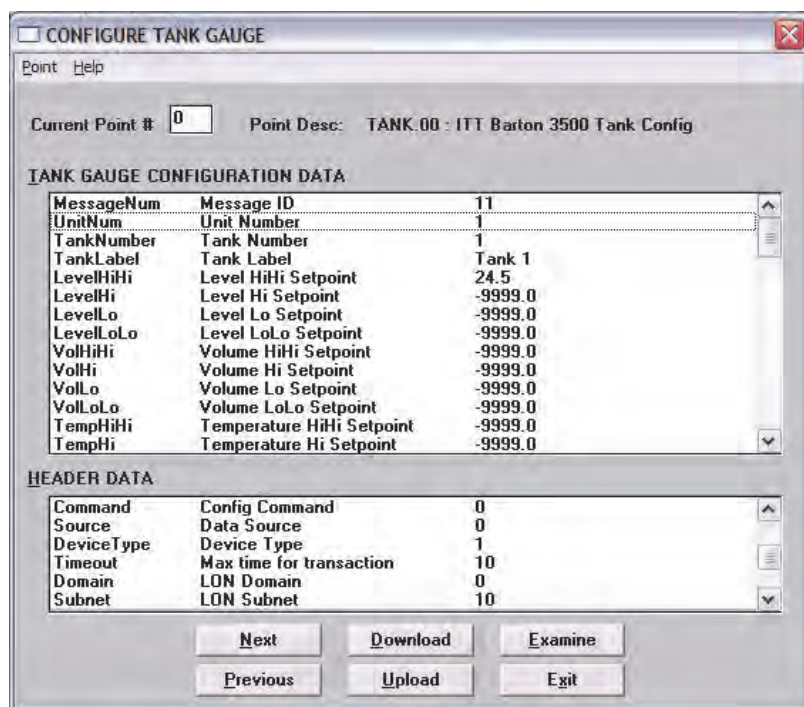

Figure 8-20: Modify Value Window

- Enter the new parameter and click store.

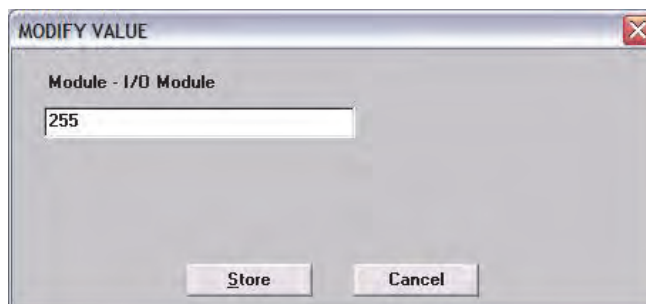

Figure 8-21: Edit Point Parameter Value Dialog

In this dialog box, the user is able to enter a value for the selected parameter. The dialog box varies according to the selected parameter. In some dialog boxes, the user is able to enter the name or data directly in the edit box. Other dialogs contain a list from which the user selects a value. The new value can then be downloaded to the 8130 RTU or stored locally if the 8130 RTU is offline.

To Modify Strap Tables

To modify strapping tables, the user will double-click the Strap Table entry in the Edit Point dialog. The Modify Strap Tables dialog appears.

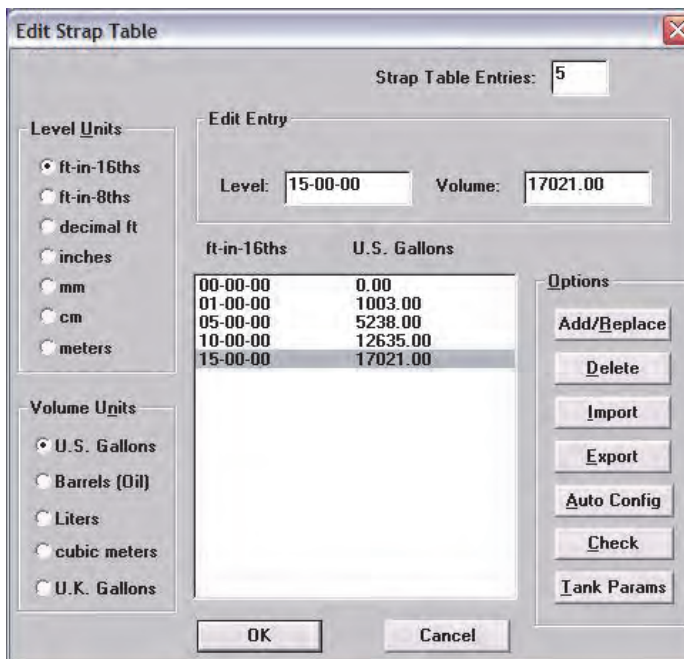

Figure 8-22: Edit Strap Table Dialog

Edit Strap Table Fields

This dialog box lets you modify tank gauge strap tables.

- Level Units

The user can convert the level units of the strap table by selecting one of the options in the Level Units list. The system asks you to confirm your selection.

- Volume Units

The user can convert the volume units of the strap table by selecting one of the options in the Volume Units list. The system asks you to confirm your selection.

- Add/Replace

The Add/Replace button lets the user add a new strap table entry or replace an entry with modified data. To create a new entry, enter the table information in the Level and Volume fields and click Add/Replace. The system creates an entry with the information you entered. To change an existing entry, select the table entry from the list window and enter the new information in the Level and Volume fields. Then click Add/Replace. The system replaces the entry with the revised data.

- Delete

The Delete button lets the user delete strap table entries. Select the entry and click Delete. The system removes the strap table entry from the list box.

- Import

The Import button lets the user import a strap table from a file. The import file must exist in the correct format with a ".TST" or ".CSV" extension. The ".TST" files are used by FuelsManager.

- Export

The Export button lets the user export the strap table from the Edit Strap Table dialog to a file.

- Check

The Check button lets the user confirm that the strap table has a valid data format. If the strap table is in the correct format, it displays the following check dialog.

If a problem exists in the strap table format, it displays the following check dialog and takes you to the entry that has the problem.

To import a strap table

1. Click Import. The Open dialog appears.

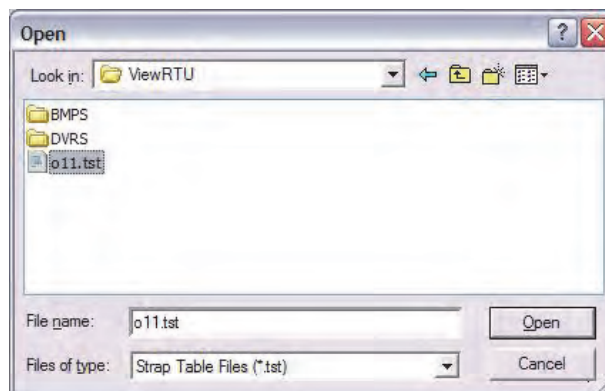

Figure 8-23: Open Dialog

2. Select or enter the file name and click OK. The system returns you to the Edit Strap Table dialog displaying the imported information.

To export the strap table

1. Click Export. The Save As dialog appears.

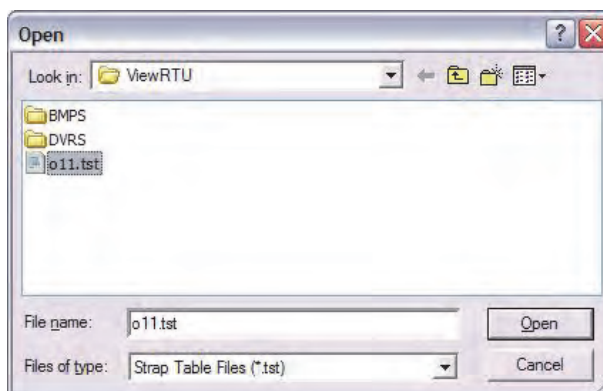

Figure 8-24: Save As Dialog

2. Enter a file name and click OK. The file name must have a “.TST” or “.CSV” extension so you can import the file at another time. The system saves the file and returns you to the Edit Strap Table dialog.

Configuring Multiple Tank Gauge Configurator Points

The spreadsheet mode is one of the methods used to configure points. This method is the most beneficial when editing and viewing multiple points of the same type. Spreadsheets of each defined point are found in the Spreadsheet Summary section in the main window.

There are some differences between the regular and spreadsheet methods. First, the user is not able to view the Point Connections window in Spreadsheet Mode. This mode is used mainly for viewing and entering point data. Second, the spreadsheet focuses on points of a single type; it does not offer a “big picture” view of multiple point types.

Adding Multiple Points

The user is able to add a point by using the same method used to add single points. The user can click on the Add Point icon or button from the toolbar or by selecting Add from the Point menu in the Main window. Once the point is added, the user is then able to define the point. Defined points appear in the Point Icon Selection Area and in the Spreadsheet Summary of the Main window.

Note The user can add a point by selecting Add from the Point menu in the Spreadsheet Mode window. This menu is described later in the section.

To add Multiple Points

1. Double-click on the desired point type in the Spreadsheet Summary. The following example Spreadsheet Mode window appears.

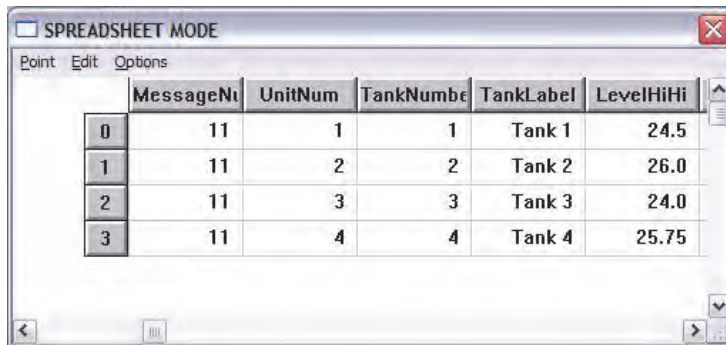

	MessageNr	UnitNum	TankNumber	TankLabel	LevelHiHi
0	11	1	1	Tank 1	24.5
1	11	2	2	Tank 2	26.0
2	11	3	3	Tank 3	24.0
3	11	4	4	Tank 4	25.75

Figure 8-25: Spreadsheet Mode Window

Note Refer to the following Entering Tank Gauge Configurator Point Data section for a description of the Spreadsheet Mode window.

Entering Tank Gauge Configurator Point Data

This section explains the window used to configure multiple points of a single point type. When the user double-clicks on a point type, the following example dialog box appears:

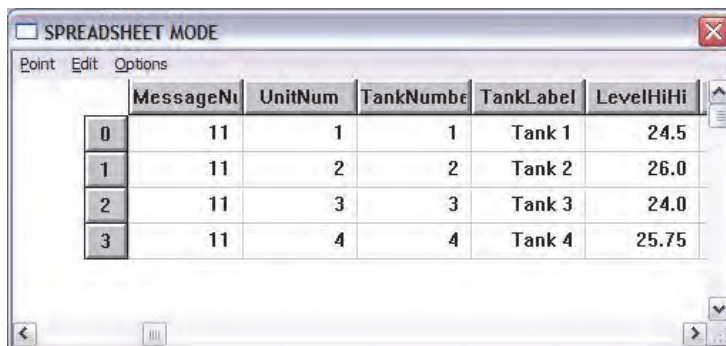

	MessageNr	UnitNum	TankNumber	TankLabel	LevelHiHi
0	11	1	1	Tank 1	24.5
1	11	2	2	Tank 2	26.0
2	11	3	3	Tank 3	24.0
3	11	4	4	Tank 4	25.75

Spreadsheet Mode: Entering Point Parameter Data

Spreadsheet Mode

This window displays a list of all the point numbers of a selected point type. The user is able to add, configure, and edit points. The user is able to select and enter the parameters for each point or group of points. The user can also export/import files and control the selection of displayed parameters.

This window is similar to the Edit Point window. The two windows contain the same parameters. In the spreadsheet mode, the user is able to view and modify all the points of the selected type. In the Edit Point window, the user steps through a window for each point number using the Next and Previous buttons.

The left two columns, D and U are used to download and upload, respectively, the information found in the corresponding row(s). The third column lists the point numbers.

Spreadsheet Mode: The Point Menu

This menu contains the same menu options found in the main window's menu bar. Refer to The Point Menu section for a description of the menu options.

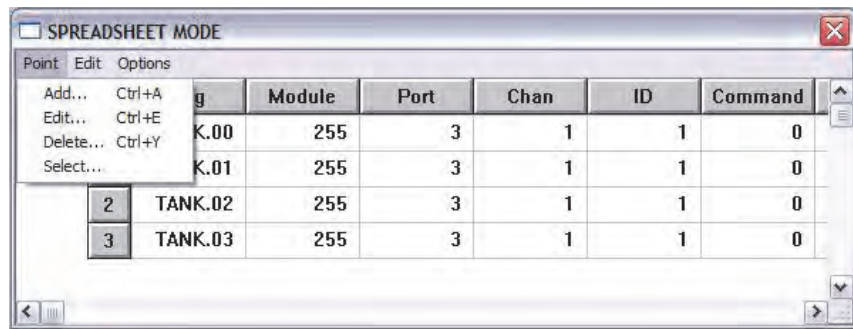

Figure 8-26: Spreadsheet Mode: Point Menu

This option is useful for creating, deleting and editing points without having to exit out of the Spreadsheet mode.

Spreadsheet Mode: The Edit Menu

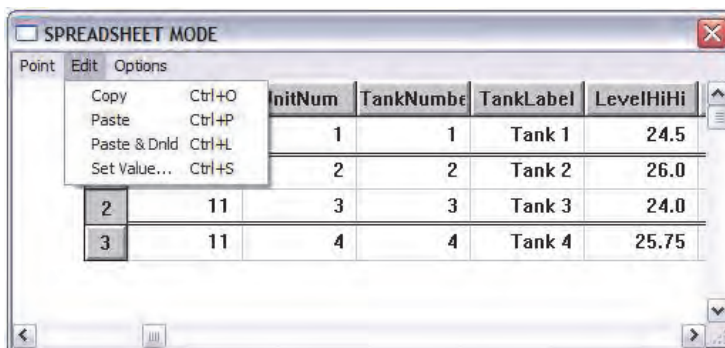

Figure 8-27: Spreadsheet Mode: The Edit Menu

Copy

The Copy option allows the user to copy data from a one or more selected cells.

To use Copy:

1. Select one or more cells to copy. To select one or more rows, click on the number(s). To select one or more columns, click on the parameter(s).
2. Select the Copy option from the Edit menu. The selected cells outline changes from black to red.

Note To undo the Copy option, press the Esc key. Pressing the Esc key removes the selection outline from the selected cells.

Paste

The Paste option allows the user to paste the copied group of cells (red outline) to the currently selected group of cells (black outline).

To use Paste:

1. Select the cells on which the copied cells will be pasted.

2. Select the Paste option from the Edit menu.

Note If the number of rows and columns in both selections do not match, the extra copied cells are truncated. Incompatible cells containing different data types are not copied; instead a warning is displayed.

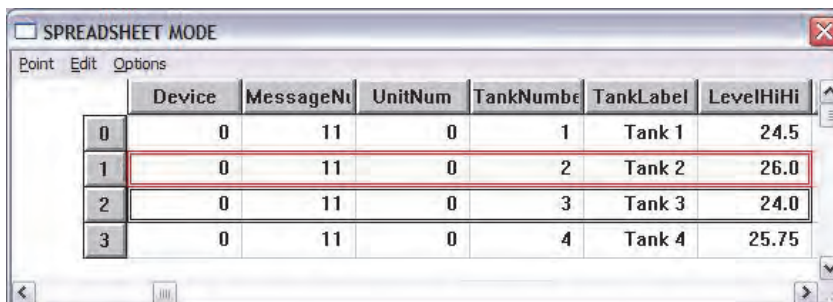

	Device	MessageNt	UnitNum	TankNumbe	TankLabel	LevelHiHi
0	0	11	0	1	Tank 1	24.5
1	0	11	0	2	Tank 2	26.0
2	0	11	0	3	Tank 3	24.0
3	0	11	0	4	Tank 4	25.75

Figure 8-28: Spreadsheet Mode: Copying and Pasting Point Parameter Data Rows #1 was Copied onto Rows #2.

Paste & Dnld

The Paste & Download option is very similar to the Paste menu selection.

Set Value

The Set Value option allows the user to enter or select a value for a parameter.

To use Set Value:

1. Click on the desired cell or column.
2. Select Set Value from the Edit menu. The Modify Value dialog box appears:.

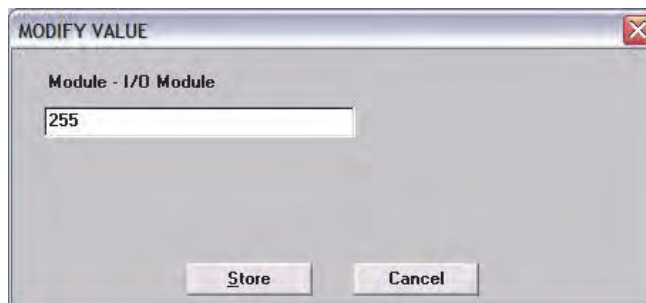

Figure 8-29: Spreadsheet Mode: Editing Point Parameter Values

3. Enter or select a value from the scroll list.

Set Value (with Auto Increment)

This option can also be used for numeric parameters such as channels to auto increment the value. Follow the procedure below.

To use Set Value with Auto Increment:

1. Click on each desired cell or column.

- Select Set Value from the Edit menu. The following dialog box appears:

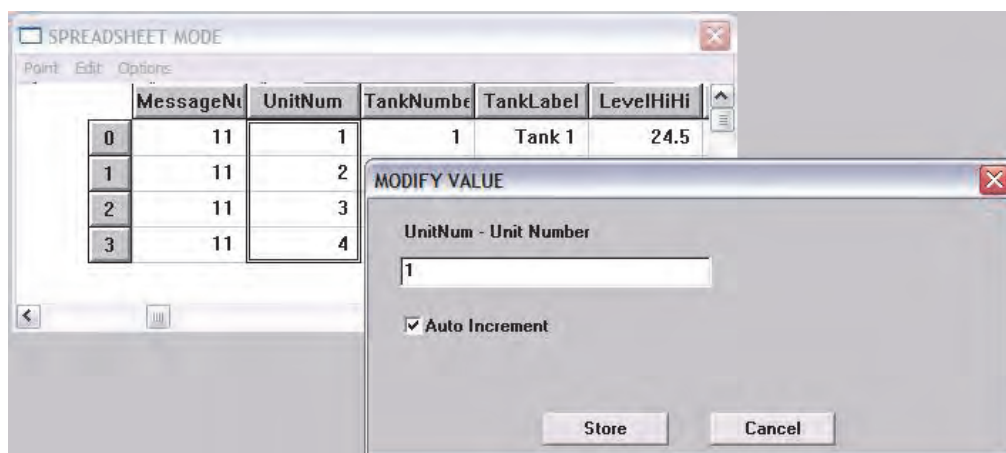

Figure 8-30: Spreadsheet Mode: Editing Point Parameter Values using Auto Increment

- Each value in the column is incremented by one for the range of rows selected. All cells that are selected and match the data type of the value are set to the value.

The Options Menu

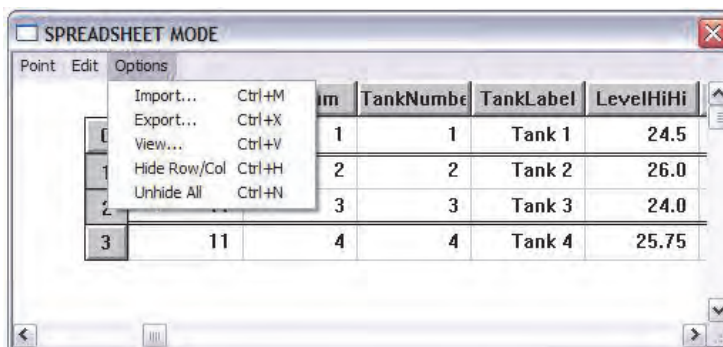

Figure 8-31: Spreadsheet Mode: The Options Menu

Import

The Import option allows the user to import a point or group of points that match the current point type. The imported file is named according to the point type with the 'CSV' file extension.

Export

The Export option allows the user to export a selected point or all the points that match the current point type to the default 8130 RTU directory. The export file is saved in a file named according to the point type with the 'CSV' file extension

Note The user is able to change the source directory in the ViewRTU.INI file.

Hide Row/Col

The Hide Row/Col option allows the user to hide selected rows or columns.

Note The Copy and Paste operations do not affect hidden rows and columns.

1. Select one or more rows or columns.
2. Select the Hide Row/Col option from the Options menu.

The selected rows or columns are indicated by a '+' in the row or column buttons heading. The following dialog box illustrates this feature.

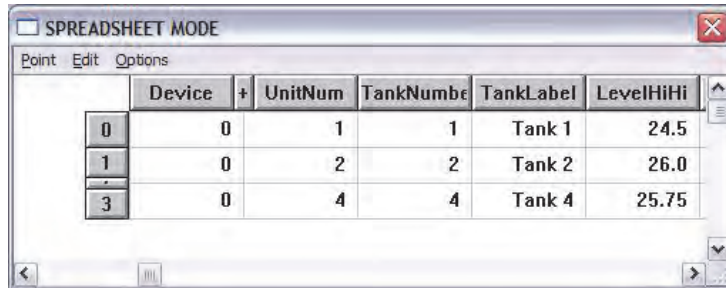

	Device +	UnitNum	TankNumber	TankLabel	LevelHiHi
0	0	1	1	Tank 1	24.5
1	0	2	2	Tank 2	26.0
3	0	4	4	Tank 4	25.75

Figure 8-32: Spreadsheet Mode: Hiding Columns

The user can unhide a row or column by clicking on the associated '+'. To unhide all the rows/columns, the user can select the Unhide All option from the Options menu.

Unhide All

The Unhide All option allows the user to reveal all of the rows or columns that are currently hidden.

9 Local Diagnostic Interface

The LDI is typically a small, menu-driven terminal with an alphanumeric keypad you can use to alter database points in the 8130 RTU from a field location. You can also use a hand-held terminal or notebook PC with the LDI. Just connect the device to the correct 8130 RTU COM port to gain access to the LDI.

With the LDI you can change the 8130 RTU in the following ways:

- Add Points: Add points to the database.
- Delete Points: Delete points from the database.
- Edit Points: Edit points in the database by point.
- Edit Tags: Edit points in the database by tag. With this function, you can only edit the points that have tags. Set the point tags in ViewRTU.
- Enter Password: Enter a Level 1 or Level 2 password to allow you to make changes to the database.

The LDI also lets you view points in the 8130 RTU in the following ways:

- List Points: List all points in the database.
- Update Mode: Continuously list database points you specify in ViewRTU. Select the points and set the update rate in ViewRTU, Internal Diagnostics (DIAG.00).
- Tank Mode: Displays data from TANK points

The following diagram maps out the process for performing 8130 RTU functions with the LDI.

The following diagram provides an overview of the LDI menus and their functions.

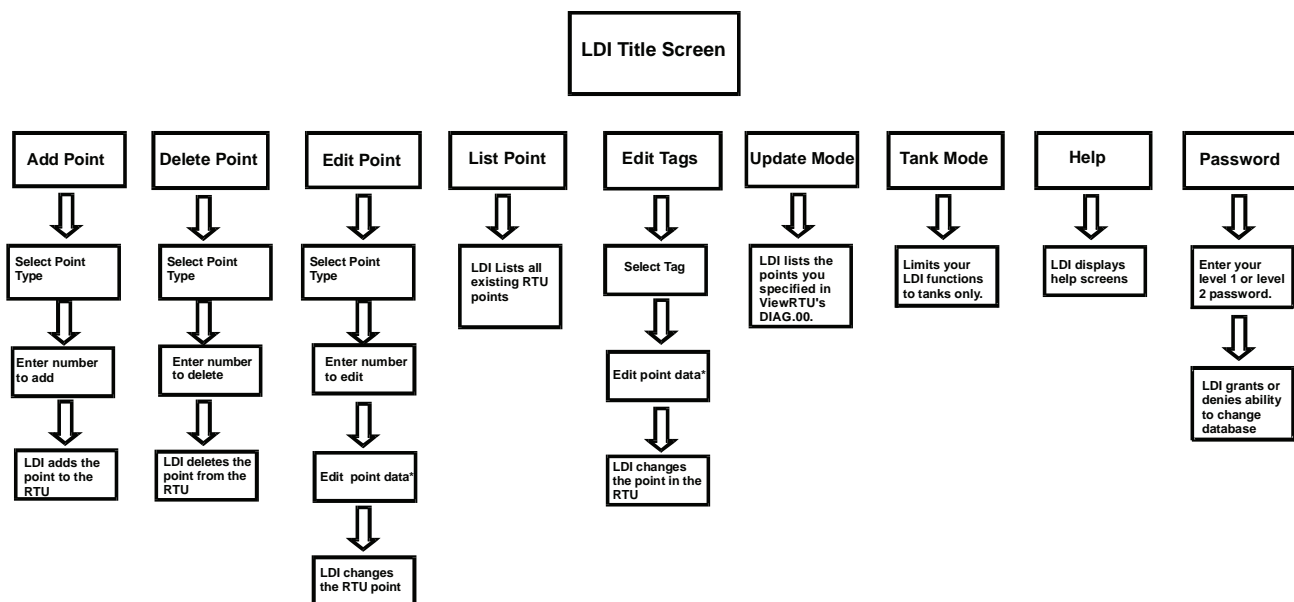

* The Edit Tags menu gives you access to the same data as Edit Point. But with Edit Tags, you can only edit points that contain an existing tag.

Figure 9-1: Overview of the LDI Menus

 LDI Environment

LDI Screen

The LDI Screen is a small, 4X20 character screen that displays menus, database points and help. When you first activate the LDI, it displays the title screen. This screen shows the 8130 RTU version number. To display the main menu from the title screen, press any key on the keypad.

```

H Help
P Enter Password
Select Mode: P
Enter Password:
  
```

Figure 9-2: LDI Main Menu Screen

LDI Keypad

You can select menu options and enter data with the LDI keypad. The LDI keypad contains 30 keys, with 27 containing secondary functions. These secondary functions include numbers, punctuation and other characters.

To enter a secondary function, press <SHIFT> before pressing the key. For example, to enter the number 1, press <SHIFT> then <H>.

F1 A	F2 B	F3 C	F4 D	↑ E
/ F	(G	1 H	2 I	3 J
* K) L	4 M	5 N	6 O
- P	# Q	7 R	8 S	9 T
+ U	, V	= W	0 X	. Y
Z	SHIFT	BKSP	SPACE	ENTER

Figure 9-3: LDI Keypad

There are cases when the LDI will only accept numbers as valid entry. In these cases, you do not have to press <SHIFT>. The LDI accepts the number value of the keys you press.

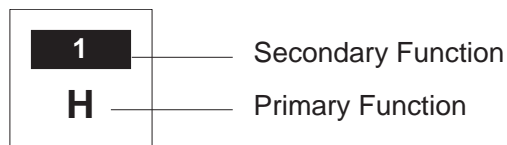

Figure 9-4: Primary and Secondary Functions

Navigating the LDI

There are a few basic functions to remember when navigating through the LDI system.

- To scroll through menu options or lists, press <ENTER>
- To go back 1 choice, screen or step, press <BKSP>.
- To return to the previous menu, press <ESC>.
- To continue after receiving an error message, press <ENTER>

Help Screens

There are help screens that exist in the LDI. These screens review some of the information in this document and provide an overview of the LDI and its functions. To reach these screens, press <H> from the main menu. Press <ENTER> to scroll through the help screens.

LDI Functions

The LDI lets you perform many tasks to the 8130 RTU. The LDI is ideal for simple additions, deletions, updates and edits. You can do them out in the field, without a PC. However, for more complicated changes, we suggest that you use the ViewRTU software.

Entering a Password

To make database changes in the LDI, you must have either the Level 1 or Level 2 password. Without a password, you can only view the 8130 RTU data.

- Level 1 gives you full access to the 8130 RTU database. The LDI will prompt you to confirm your database changes before making them.
- Level 2 gives you full access to the 8130 RTU database. The LDI immediately makes the database changes as you enter them.

To enter an LDI password

1. From the main menu, press <P>. The system prompts you to enter a password.
2. Enter your Level 1 or Level 2 password and press <ENTER>.

```
H Help
P Enter Password
Select Mode: P
Enter Password:
```

Figure 9-5: Main Menu

- If the password is incorrect the LDI beeps and displays “Access Denied.”
- If the password is correct the LDI returns you to the main menu.

Adding a Point

You can create an 8130 RTU point with the LDI, just as you can in ViewRTU. To add a point to the 8130 RTU using the LDI Interface:

Adding a Point

1. From the main menu, press <A>. The point type menu appears.

```

1  SYS    2  COM
3  DIAG   4  CLK
5  IO     6  DI
Add Pnt Type:

```

Figure 9-6: Add Point Type

2. Press <Enter> to scroll through the point types.
3. Select the point type you want to add to the database by pressing its corresponding number from the menu and pressing <ENTER>. The LDI prompts you for the number of the point to add.

```

3  DIAG   4  CLK
5  IO     6  DI
Add Pnt Type:6
# to add: DI.

```

Figure 9-7: Numbering the Point

4. Enter the number and press <ENTER>.
 - If you entered a valid number, the LDI adds the point to the 8130 RTU database and displays “Point Added” on the LDI screen.
 - If you entered an invalid number, the LDI rejects the number and returns you to the Point Types screen.
 - If you only have Level 1 LDI security, the LDI prompts you to confirm the change. Press <Y> to proceed or <N> to cancel the edit.
5. Enter the point data.

Note Unlike ViewRTU, the LDI does not automatically configure a new point with any default settings. So after adding a point with the LDI, be sure to enter all important point data with the Edit Point function.

Deleting a Point

You can delete an existing point from the 8130 RTU database by using the Delete Point function.

To delete a point from the 8130 RTU database using the LDI Interface:

Delete a point from the 8130 RTU database

1. From the LDI main menu, press <D>. The Point type menu appears.
2. Select the point type you want to delete by pressing its corresponding number and pressing <ENTER>. The LDI prompts you for the point number to delete.

```

  3 DIAG    4 CLK
  5 IO      6 DI
Del Pnt Type: 6
# to del: DI.
```

Figure 9-8: Delete Point Type

3. Enter the point number and press <ENTER>.
 - If you only have Level 1 LDI security, the LDI prompts you to confirm the change. Press <Y> to proceed or <N> to cancel the edit.
4. The system deletes the point and displays “Point Deleted.”
 - If you entered an invalid entry, or the point cannot be deleted, the LDI displays an error message. Press <ENTER> to return to the point type menu.

Editing a Point

The LDI lets you edit point data in the 8130 RTU database, just as you can in ViewRTU. You can also use this function just after adding a point, since the LDI does not configure the point with the ViewRTU default settings.

To edit a point that already exists in the 8130 RTU database using the LDI Interface:

Edit a point in the 8130 RTU database

1. From the main menu, press <E>. The point type menu appears.
2. Press <ENTER> to scroll through the point types.
3. Select the point type you want to edit by pressing the point type’s corresponding number, then pressing <ENTER>. The system prompts you for the number to edit.

```

  3 DIAG    4 CLK
  5 IO      6 DI
Edit Pnt Type: 6
# to edit: DI.
```

Figure 9-9: Edit Point Type

4. Enter the point number you want to edit and press <ENTER>. The point data appears.
5. Press <ENTER> to scroll through the point data. The data will update in real time.
6. To change the point, type over the existing data and press <ENTER>.
 - If you entered an invalid entry, the LDI screen displays “Invalid Value.” Press <ENTER> and enter the change again.

- If you only have Level 1 LDI security, the LDI prompts you to confirm the change. Press <Y> to proceed or <N> to cancel the edit.
7. The LDI changes the point.

Listing Points

You can get a list of all the 8130 RTU points by using the LDI List Points function. This function lists each point. It also shows a point's tag if one exists. To list points using the LDI screen:

Viewing a list of all points

1. From the main menu, press <L>. The system lists the 8130 RTU database points.

```
DI.0: Pump1
DI.2: Pump3
DI.4: Pump Backup
DI.6: Reserve Pump
```

Figure 9-10: Point List

2. Press <ENTER> to scroll through the points. If a tag exists, the LDI displays it with the point.

Edit Tags

From the LDI, you can edit points in the 8130 RTU by referring to their tag. To change an existing tag:

Edit points via their Tag

1. From the main menu, press <T>. The LDI screen lists the existing tags.

```
1 Pump1
2 Pump2
3 Pump3
# to edit:
```

Figure 9-11: Tag List

2. Press <ENTER> to scroll through the tags.
3. When the tag you want to edit appears on the screen, press the number to the left of the tag you want to change. The tag information appears. From this screen you can change point data just as you can when you edit a point.

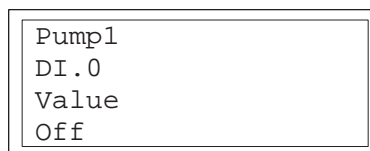

Figure 9-12: Tag Information

4. Press <ENTER> to scroll through the tag point's data.
5. When the information you want to change appears, enter the new information in its place and press <ENTER>.

Update Mode

In ViewRTU, you can configure the LDI to continuously display certain points. To program which points you want the LDI to display, use the ViewRTU Internal Diagnostics (DIAG.00) software block.

Configuring Update Mode

Before you can set the LDI to Update Mode, you must configure the ViewRTU Internal Diagnostics (DIAG.00) software block to reflect the data you want to show. To configure the LDI to continuously display points, use ViewRTU to do the following:

Using ViewRTU to continuously display points

1. Double-right-click on the Internal diagnostics (DIAG.00) icon. The Edit Point dialog box appears.

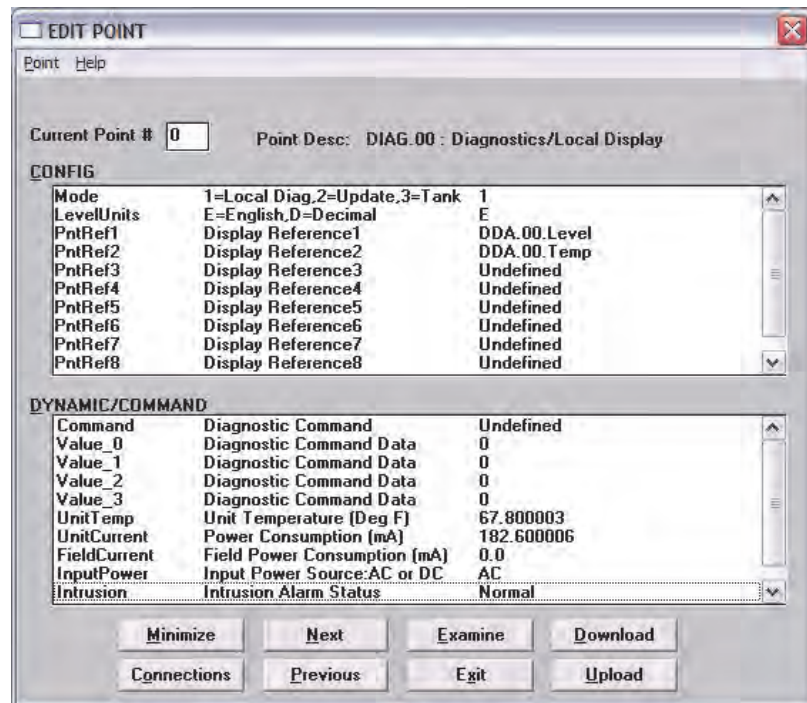

Figure 9-13: Edit Point Dialog

2. Double-click on a PntRef row. The Modify Reference dialog box appears.

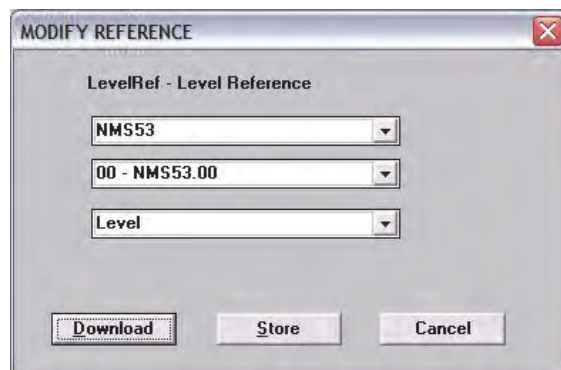

Figure 9-14: Modify Reference Dialog

3. Choose the point you want the LDI to display by selecting the type.number.parameter values from the pull-down menus.
4. When you finish making your selection, press Download. The LDI adds the point to the CONFIG window in the Edit Point dialog.
5. Repeat this process until you have entered all the points you want the LDI to list.

To set the update rate:

1. From the Internal Diagnostics, Edit Point dialog box, double-click on the UpdateRate row. The Modify Value dialog box appears, displaying the current update rate.

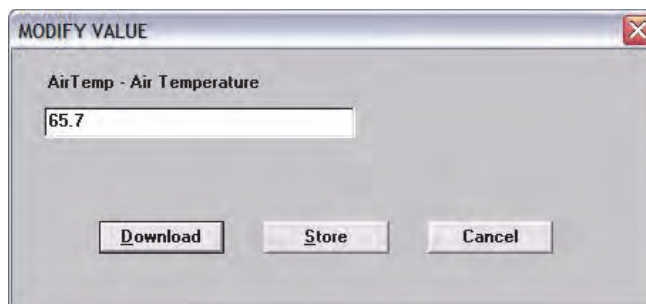

Figure 9-15: Modify Value Dialog

2. Enter a new update rate and click Download.

Viewing Update Mode

To set the LDI to list the points you entered in ViewRTU's Internal Diagnostics, press <U> from the LDI main menu to activate the Update Mode. The LDI screen lists the points you entered in ViewRTU Internal Diagnostics.

```
Pump1
DI.0
Value
Off
```

Figure 9-16: Points Entered with ViewRTU Diagnostics

To return to the main menu while in Update Mode, press <ESC>.

Tank Mode

You can set the LDI to Tank Mode if you only want to view, add, and edit tank information. Tank Mode works just like Edit Point, but limits LDI use to tank points only.

1. To set the LDI to Tank Mode, press <T> from the main menu. The LDI lists the tank points.

```
1 TANK.00
2 TANK.01
3 TANK.02
# to edit:
```

Figure 9-17: Tank Points

2. From this point, the LDI works just like Edit Point, but here you are only working with tank points.

10 Troubleshooting

This chapter describes the procedures used to isolate hardware faults. Three icons and eight status Led provide verification of correct operation. If the 8130 RTU is not functioning normally, the user is able to troubleshoot the device by performing one or more procedures using the three icons. These icons and indicators are also described in the Motherboard & I/O Expansion Module Configuration chapter.

Troubleshooting the 8130 RTU Motherboard

LED Displays Under Normal Conditions

Operations are normal if the Run, I/O and On-line indicators are flashing. the table below represents the normal conditions for the Run, Output and On-line indicators.

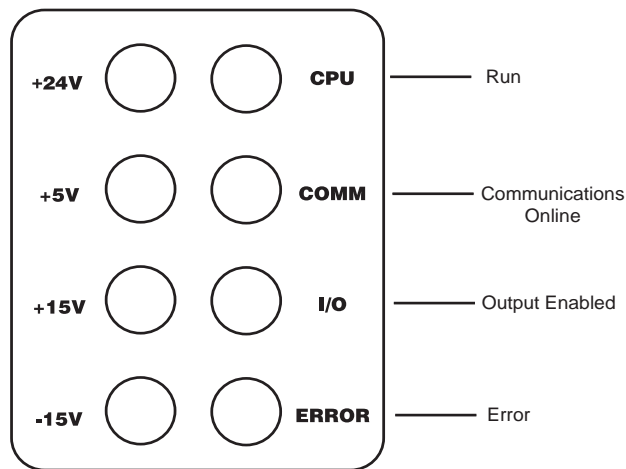

Figure 10-1: 8130 RTU LED Indicators

Indicator	Condition
Run	Flashes once every second.
Communications	Toggles when the system is receiving data. Idle when not transmitting data.
I/O	Toggles occasionally if intelligent I/O modules are installed. Every transaction with an intelligent I/O module causes the I/O LED to toggle
Error	On if a non-recoverable error has occurred

Run Indicator

The RUN Indicator provides the single most important feedback of proper system operation. When the system functions properly, the RUN Indicator is constantly flashing at a 1Hz rate. If this indicator ever goes to a steady state condition, either on or off, some malfunction has occurred. In addition, relative processor loading can be determined by observing the RUN Indicator duty cycle. Under normal conditions, this indicator flashes once every second.

If the Run LED is flashing rapidly (10 Hz), the 8130 RTU is in Boot mode, indicating the 8130 RTU firmware is either corrupt or nonexistent.

Communications Indicator

The Communications indicator provides communication line status. When it is toggling, the system is exchanging data. As the system receives a valid message from the Host, this indicator toggles. If the indicator is idle, the system is off-line.

I/O Indicator

When this LED is toggling, the system is exchanging data between the 8130 RTU and any intelligent I/O module.

LED Displays Under Abnormal Conditions

The table below lists the abnormal conditions of the four indicator lights. From this table the user should be able to pinpoint the cause and derive a solution to the problem.

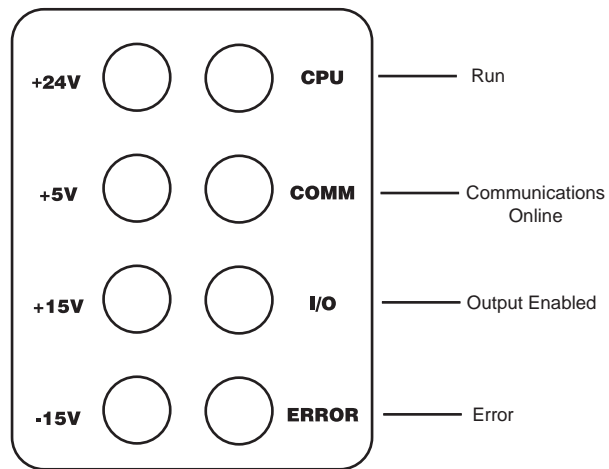

Figure 10-2: 8130 RTU LED Indicators under Abnormal Conditions

Indicator	Condition	Cause	Solution
Run	Does not flash (even after hard reset)	Bad database Bad main circuit board	Perform Hard Reset then reload database Replace main circuit board
	Flashes rapidly	No firmware or firmware is corrupt	Check jumper settings for memory on motherboard Download the firmware again
	Steady ON/OFF	system failure	

Indicator	Condition	Cause	Solution
Communication	Steady state	DIP switch setting	Check unit ID DIP switch setting: set ID number and reset system
		COM point	Check COM point with diagnostics terminal or ViewRTU
		COM parameters	Verify time-out, baud, and protocol parameters have the correct values set
		bad communications	Check for bad communication line, modem board or main circuit board *
		wrong jumper settings	Check W6 & W7 for proper settings
+24	OFF	bad fuse	Check fuse at F2

Using the 8130 RTU icons

Reinitializing System Hardware

To reinitialize the system hardware:

1. Press the RESET Switch.

This action causes it to go to a known starting state. This switch may be pressed at any time; however, the following will also occur:

- Reinitialize System Hardware
- Clear Working Memory
- Reinitialize Data Base
- Reset All Timers
- Disable Outputs
- Enable Communications
- Present Sign-on Message to Diagnostic Terminal

Performing a Hard Reset

A special form of Reset is available for occasions when the battery backed-up database must be reinitialized. A Hard Reset should be performed before a database is downloaded from the portable PC or hand-held terminal display.

Caution A Hard Reset clears the installed database.

To perform a Hard Reset:

1. Simultaneously press the Reset, On-line and Output Enable buttons.
2. Release Reset. Continue pressing other buttons until the red ERROR LED light comes ON.
3. Release the Online and Output Enable button.

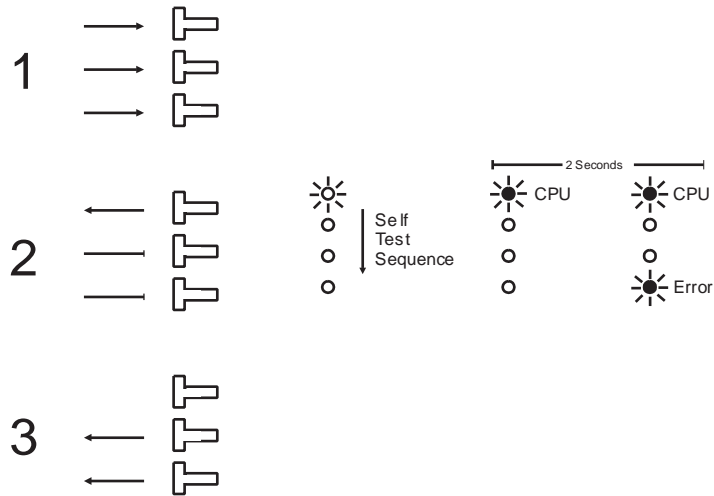

Figure 10-3: 8130 RTU Hard Reset

The Hard Reset should be used as a last resort if the 8130 RTU is not functioning. A Hard Reset clears the installed database.

8130 RTU Motherboard Power Adjustments and Verification

Power Supply Adjustment

To adjust the power supply:

1. Measure +24V power supply voltage across pin 19 (+) and pin 1 (common) of P1.
2. Adjust (R101) until the value equals +24.00V.

Supply Voltage Verification

Verify that the supply voltages at Power Connector P1 are as described in the following table:

Pin Numbers	Voltage
Pin 19 (+) and Pin 1 (common)	+24V
Pin 39 (+) and Pin 1 (common)	+24V
Pin 21 (+) and Pin 1 (common)	+5V
Pin 40 (+) and Pin 1 (common)	+15V
Pin 20 (+) and Pin 16 (common)	-15V

If +24 voltages is out of tolerance, adjust the power supply potentiometer (R101).

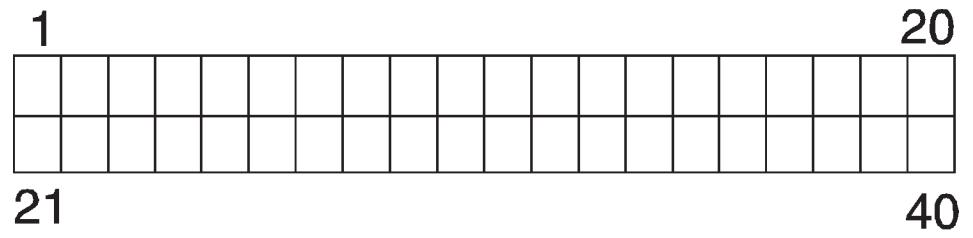

Figure 10-4: Refer to the Figure below for P1 Pin Assignments:

11 Order Codes

8130 Remote Terminal Unit

10	Power Supply	0	Power supply 90 - 130 V _{ac} 50/60 Hz
		1	Power supply 220 - 240 V _{ac} 50/60 Hz
		2	Power supply 18 - 36 V _{dc}
20	Host Emulation	0	Additional options not used
		2	TSU emulation (Varec Tankview Systems)
		3	CIU emulation (Enraf model 858 CIU interface)
30	Special Field Communications	0	Additional options not used
		4	Varec Matrix communication (Interfaces to Varec Matrix devices, 1600/1700) and requires 8210, 8201 & 8204 modules)
		5	MODBUS master communication (uses RTU motherboard communications ports)
		6	CIU communication (Interfaces to existing Enraf 858 CIU devices)
60	Calculations	0	Additional options not used
		7	Hybrid tank calculations
		8	Hydrostatic tank calculations
70	Strapping Tables	0	Additional options not used
		9	Embedded tank strapping tables
80	Approvals	0	For use in non-hazardous areas
		1	FM Cl.I Div. 2 Gr. A,B,C,D T3C (3015423) Optional enclosure required.
		2	CSA Cl.I Div.2 Gr. A,B,C,D (LR 40894) Optional enclosure required.
N8130-			Complete product designation

Ordering Structure 8130 RTU NEMA 4 Enclosure for use in Class I Div 2 areas

Enclosure Type	
140061213	20x24x8 in. with 48VDC supply
140061562	24x20x8 in.
140061564	24x24x6 in. with 24VDC supply and Modem
140061566	24x20x8 in. with Front Panel Display, no Power Supply

Ordering Structure Miscellaneous Options

	Modem Only (specify type)
280061489	Front Panel Display

Ordering Structure I/O Module Options

450061357	DC Output Module 3-60 VDC Normally Open
450061358	AC Input Module 0-140VAC 8mA
450061368	AC Output Module 24-140VAC Normally Open

450061369	DC Input Module 3–32 VDC 18mA
450061387	AC Input Module 90–140 VAC
450061388	AC Output Module 12–140 VAC Normally Open
450061389	DC Input Module 10–32 VDC
450061390	DC Output Module 5–60 VDC Normally Open
450061621	AC Input Module 240 VAC
450061582	AC Output Module 240 VAC Normally Open
450061491	Analog Input Module 4–20mA (use with 8204 only)
450061574	OPTO 22 #G4ODC5R5 Normally Closed
450061623	High Speed Pulse Input Module 1–5VDC

Ordering Structure Expansion Modules

Module		Slots
N8201–	16–Channel Digital In–/Out	2
N8203–	Dual RS–485 Communication Interface	
	Option 2 – Modbus™ protocol	1
	Option 3 – DDA protocol	1
	Option 4 – Petrosense Probe protocol	1
N8204–	8–Channel Multi–Function Module	1
N8205–	16–Channel Analog Input Module	
	Option 1 – Class 1 Div. 2 Hazardous location certification	2
N8207–	8–Channel Analog Output	1
N8208–	TIWAY Interface	1
N8210–	Varec Mark/Space Interface	1
	Option 1 – Mark/Space Micro 4–wire (1800/1900/4000)	
	Matrix (1600/1700)	
N8211–	Current Loop Interface	1
	Option 1 – Whessoe Bus protocol	
	Option 2 – GPE protocol	
N8212–	Saab Interface	1
N8213–	V1 Interface (Varec)	1
N8214–	Enraf Interface	1
N8215–	L&J Tankway Interface	1
N8216–	LON Interface (Barton Instruments)	1
N8217–	Dual RS–232 Interface	1
	Option	Product designation

See control panel installation detail on facing page.

FIELD WIRING: (U.S. INSTALLATIONS ONLY)

- INDIVIDUAL SHIELDED PAIRS ARE RECOMMENDED FOR ALL SIGNAL AND COMMUNICATION CIRCUITS.
- ALL SIGNAL SHIELD WIRING SHOULD BE TAPED AND INSULATED AT THE INSTRUMENT LOCATION.
- REFER TO SERIES 8130RTU OPERATIONS AND MAINTENANCE MANUAL FOR ADDITIONAL INFORMATION.
- RTU MAY BE INSTALLED IN DIVISION 2 HAZARDOUS LOCATION WHEN USED WITH NEMA 4 ENCLOSURE.
- SUBSTITUTION OF COMPONENTS MAY IMPAIR SUITABILITY FOR CLASS 1, DIVISION 2.
- DO NOT DISCONNECT EQUIPMENT UNLESS POWER HAS BEEN SWITCHED OFF OR AREA IS KNOWN TO BE NON-HAZARDOUS.
- REPLACE FUSES ONLY WHEN LOCATION IS KNOWN TO BE NON-HAZARDOUS OR INPUT POWER IS DISCONNECTED.
- INSTALLATION MUST BE IN ACCORDANCE WITH THE NEC/CEC AS APPLICABLE.
- THE MAXIMUM NON-HAZARDOUS LOCATION VOLTAGE IS 250V AC/DC.
- GROUNDING TERMINALS FOR MODEL 8202-1, 8202-1, 8205-1, OR 8205-2 SHOULD BE CONNECTED TO A GROUNDING ELECTRODE BY REDUNDANT 14AWG INSTALLED CONDUCTIONS.
- RESISTANCE FROM MODEL 8202-1, 8202-2, 8205-1, OR 8205-2, GROUND TO GROUNDING ELECTRODE MUST NOT EXCEED ONE OHM.
- ANALOG INPUT SIGNALS FROM INSTRUMENTS LOCATED IN CLASS 1, DIVISION 2 GROUPS AND HAZARDOUS LOCATIONS MUST BE INSTALLED TO THE MODEL 8202-1, 8205-1, 8205-2, OR 8205-2 USING THE FOLLOWING ASSOCIATED NONINDEPENDENT FIELD PARAMETERS:

VOC ≤ 26.80 V
 ISC ≤ 159.00 mA
 Co ≥ 0.13μF + C-cable FOR GROUP A & B
 0.90μF + C-cable FOR GROUP C
 2.40μF + C-cable FOR GROUP D
 Lo ≥ 2.50mH + L-cable FOR GROUP A & B
 5.80mH + L-cable FOR GROUP C
 11.00mH + L-cable FOR GROUP D

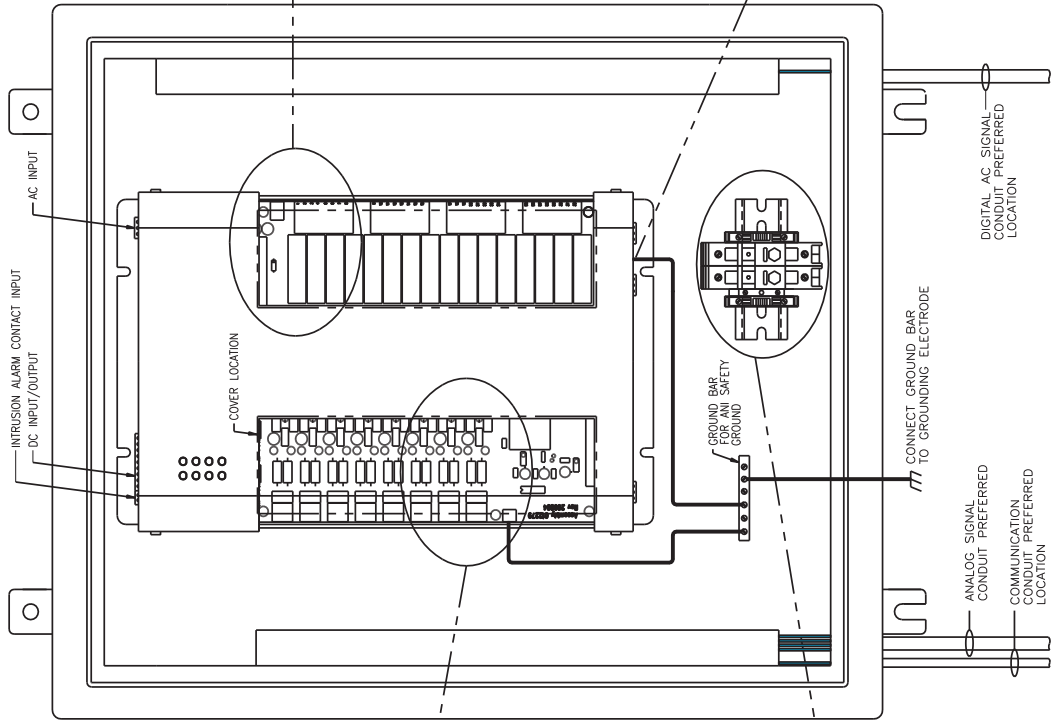

8202/8205 NOTES:

- CENTER TERMINAL IS SHIELD GROUND CONNECTION.

MODEL #8202 & 8205
 TYPICAL ANALOG SIGNAL WIRING

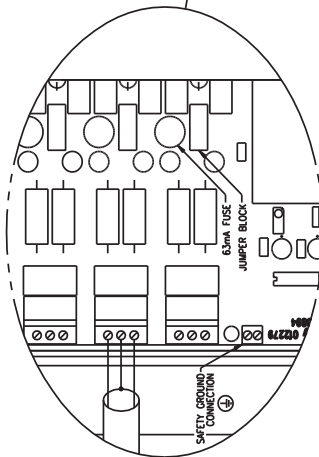

MODEL 8201
 TYPICAL DIGITAL SIGNAL WIRING

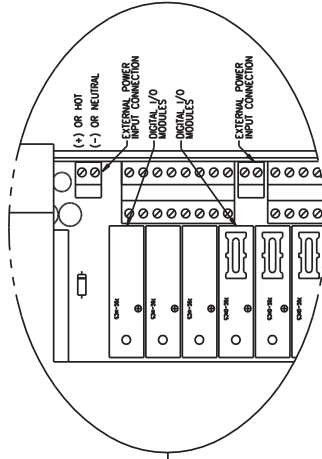

TYPICAL POWER WIRING
 AC INPUT POWER BLOCK

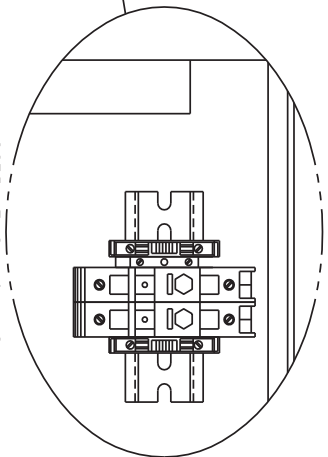

COMMUNICATIONS
 SURGE GROUND

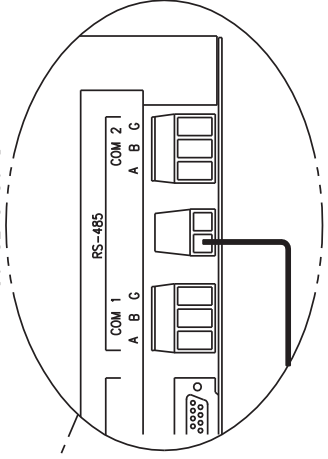

FRONT VIEW

