

# Proline Promass F 300 Modbus RS485 Coriolis Flowmeter

## Operating Instructions Manual

---

BA01668O/06/EN/04.19

Valid as of version 01.05.zz (Device firmware)

71454923

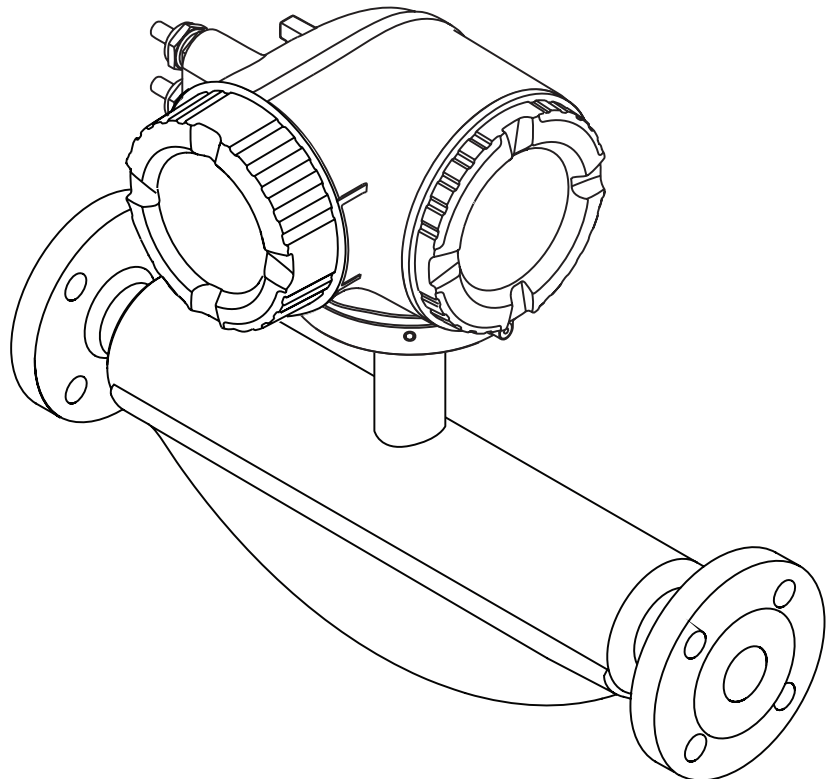

- Make sure the document is stored in a safe place such that it is always available when working on or with the device.
- To avoid danger to individuals or the facility, read the "Basic safety instructions" section carefully, as well as all other safety instructions in the document that are specific to working procedures.
- The manufacturer reserves the right to modify technical data without prior notice. Your Endress+Hauser Sales Center will supply you with current information and updates to these Instructions.

## ***Important***

---

All information and technical specifications in this documentation have been carefully checked and compiled by the author. However, we cannot completely exclude the possibility of errors. TechnipFMC is always grateful to be informed of any errors. Contact us on the website.

Smith Meter® is a registered trademark of TechnipFMC.

## ***Technical Support***

---

Contact Information:

### ***Field Service Response Center***

24/7 Technical Support/Schedule a Technician: 1-844-798-3819

System Installation Supervision, Start-Up, and Commissioning Services Available

## ***Customer Support***

---

Contact Information:

### ***Customer Service***

TechnipFMC

1602 Wagner Avenue

Erie, Pennsylvania 16510 USA

P: +1 814 898-5000

F: +1 814 899-8927

[measurement.solutions@TechnipFMC.com](mailto:measurement.solutions@TechnipFMC.com)

[TechnipFMC.com](http://TechnipFMC.com)

Literature Library:

[http://info.smithmeter.com/literature/online\\_index.html](http://info.smithmeter.com/literature/online_index.html)

# Table of contents

<b>1</b>	<b>About this document</b> . . . . .	<b>6</b>		
1.1	Document function . . . . .	6		
1.2	Symbols . . . . .	6		
1.2.1	Safety symbols . . . . .	6		
1.2.2	Electrical symbols . . . . .	6		
1.2.3	Communication symbols . . . . .	7		
1.2.4	Tool symbols . . . . .	7		
1.2.5	Symbols for certain types of information . . . . .	7		
1.2.6	Symbols in graphics . . . . .	8		
1.3	Documentation . . . . .	8		
1.3.1	Standard documentation . . . . .	8		
1.3.2	Supplementary device-dependent documentation . . . . .	9		
1.4	Registered trademarks . . . . .	9		
<b>2</b>	<b>Safety instructions</b> . . . . .	<b>10</b>		
2.1	Requirements for the personnel . . . . .	10		
2.2	Designated use . . . . .	10		
2.3	Workplace safety . . . . .	11		
2.4	Operational safety . . . . .	11		
2.5	Product safety . . . . .	12		
2.6	IT security . . . . .	12		
2.7	Device-specific IT security . . . . .	12		
2.7.1	Protecting access via hardware write protection . . . . .	13		
2.7.2	Protecting access via a password . . . . .	13		
2.7.3	Access via Web server . . . . .	14		
2.7.4	Access via service interface (CDI- RJ45) . . . . .	14		
<b>3</b>	<b>Product description</b> . . . . .	<b>15</b>		
3.1	Product design . . . . .	15		
<b>4</b>	<b>Incoming acceptance and product identification</b> . . . . .	<b>16</b>		
4.1	Incoming acceptance . . . . .	16		
4.2	Product identification . . . . .	17		
4.2.1	Transmitter nameplate . . . . .	18		
4.2.2	Sensor nameplate . . . . .	19		
4.2.3	Symbols on measuring device . . . . .	20		
<b>5</b>	<b>Storage and transport</b> . . . . .	<b>21</b>		
5.1	Storage conditions . . . . .	21		
5.2	Transporting the product . . . . .	21		
5.2.1	Measuring devices without lifting lugs . . . . .	21		
5.2.2	Measuring devices with lifting lugs . . . . .	22		
5.2.3	Transporting with a fork lift . . . . .	22		
5.3	Packaging disposal . . . . .	22		
<b>6</b>	<b>Installation</b> . . . . .	<b>23</b>		
6.1	Installation conditions . . . . .	23		
6.1.1	Mounting position . . . . .	23		
6.1.2	Environment and process requirements . . . . .	26		
6.1.3	Special mounting instructions . . . . .	28		
6.2	Mounting the measuring device . . . . .	30		
6.2.1	Required tools . . . . .	30		
6.2.2	Preparing the measuring device . . . . .	30		
6.2.3	Mounting the measuring device . . . . .	30		
6.2.4	Turning the transmitter housing . . . . .	31		
6.2.5	Turning the display module . . . . .	31		
6.3	Post-installation check . . . . .	32		
<b>7</b>	<b>Electrical connection</b> . . . . .	<b>33</b>		
7.1	Connection conditions . . . . .	33		
7.1.1	Required tools . . . . .	33		
7.1.2	Requirements for connecting cable . . . . .	33		
7.1.3	Terminal assignment . . . . .	36		
7.1.4	Shielding and grounding . . . . .	36		
7.1.5	Preparing the measuring device . . . . .	36		
7.2	Connecting the measuring device . . . . .	37		
7.2.1	Connecting the transmitter . . . . .	37		
7.2.2	Connecting the remote display and operating module DKX001 . . . . .	40		
7.3	Ensuring potential equalization . . . . .	40		
7.3.1	Requirements . . . . .	40		
7.4	Special connection instructions . . . . .	41		
7.4.1	Connection examples . . . . .	41		
7.5	Hardware settings . . . . .	45		
7.5.1	Setting the device address . . . . .	45		
7.5.2	Enabling the terminating resistor . . . . .	45		
7.6	Ensuring the degree of protection . . . . .	46		
7.7	Post-connection check . . . . .	46		
<b>8</b>	<b>Operation options</b> . . . . .	<b>47</b>		
8.1	Overview of operation options . . . . .	47		
8.2	Structure and function of the operating menu . . . . .	48		
8.2.1	Structure of the operating menu . . . . .	48		
8.2.2	Operating philosophy . . . . .	50		
8.3	Access to the operating menu via the local display . . . . .	51		
8.3.1	Operational display . . . . .	51		
8.3.2	Navigation view . . . . .	53		
8.3.3	Editing view . . . . .	55		
8.3.4	Operating elements . . . . .	57		

8.3.5	Opening the context menu . . . . .	58	10.3.10	Configuring the relay output . . . . .	105
8.3.6	Navigating and selecting from list . . .	59	10.3.11	Configuring the double pulse output	108
8.3.7	Calling the parameter directly . . . . .	60	10.3.12	Configuring the local display . . . . .	109
8.3.8	Calling up help text . . . . .	60	10.3.13	Configuring the low flow cut off . . . .	114
8.3.9	Changing the parameters . . . . .	61	10.3.14	Configuring the partial filled pipe detection . . . . .	115
8.3.10	User roles and related access authorization . . . . .	61	10.4	Advanced settings . . . . .	116
8.3.11	Disabling write protection via access code . . . . .	62	10.4.1	Using the parameter to enter the access code . . . . .	117
8.3.12	Enabling and disabling the keypad lock . . . . .	62	10.4.2	Calculated values . . . . .	117
8.4	Access to the operating menu via the Web browser . . . . .	62	10.4.3	Carrying out a sensor adjustment . . .	118
8.4.1	Function range . . . . .	62	10.4.4	Configuring the totalizer . . . . .	119
8.4.2	Prerequisites . . . . .	63	10.4.5	Carrying out additional display configurations . . . . .	122
8.4.3	Establishing a connection . . . . .	64	10.4.6	WLAN configuration . . . . .	127
8.4.4	Logging on . . . . .	67	10.4.7	Configuration management . . . . .	129
8.4.5	User interface . . . . .	67	10.4.8	Using parameters for device administration . . . . .	130
8.4.6	Disabling the Web server . . . . .	68	10.5	Simulation . . . . .	132
8.4.7	Logging out . . . . .	69	10.6	Protecting settings from unauthorized access . . . . .	136
8.5	Access to the operating menu via the operating tool . . . . .	69	10.6.1	Write protection via access code . . .	136
8.5.1	Connecting the operating tool . . . . .	69	10.6.2	Write protection via write protection switch . . . . .	137
8.5.2	FieldCare . . . . .	72			
8.5.3	DeviceCare . . . . .	73			
<b>9</b>	<b>System integration . . . . .</b>	<b>75</b>	<b>11</b>	<b>Operation . . . . .</b>	<b>139</b>
9.1	Overview of device description files . . . . .	75	11.1	Reading the device locking status . . . . .	139
9.1.1	Current version data for the device . . .	75	11.2	Adjusting the operating language . . . . .	139
9.1.2	Operating tools . . . . .	75	11.3	Configuring the display . . . . .	139
9.2	Compatibility with earlier model . . . . .	75	11.4	Reading measured values . . . . .	139
9.3	Modbus RS485 information . . . . .	76	11.4.1	"Measured variables" submenu . . . . .	140
9.3.1	Function codes . . . . .	76	11.4.2	"Totalizer" submenu . . . . .	142
9.3.2	Register information . . . . .	77	11.4.3	"Input values" submenu . . . . .	142
9.3.3	Response time . . . . .	77	11.4.4	Output values . . . . .	144
9.3.4	Data types . . . . .	77	11.5	Adapting the measuring device to the process conditions . . . . .	146
9.3.5	Byte transmission sequence . . . . .	78	11.6	Performing a totalizer reset . . . . .	146
9.3.6	Modbus data map . . . . .	79	11.6.1	Function scope of the "Control Totalizer" parameter . . . . .	147
<b>10</b>	<b>Commissioning . . . . .</b>	<b>81</b>	11.6.2	Function scope of the "Reset all totalizers" parameter . . . . .	147
10.1	Function check . . . . .	81	11.7	Showing data logging . . . . .	148
10.2	Setting the operating language . . . . .	81	<b>12</b>	<b>Diagnostics and troubleshooting . .</b>	<b>153</b>
10.3	Configuring the measuring device . . . . .	81	12.1	General troubleshooting . . . . .	153
10.3.1	Defining the tag name . . . . .	83	12.2	Diagnostic information via light emitting diodes . . . . .	155
10.3.2	Setting the system units . . . . .	83	12.2.1	Transmitter . . . . .	155
10.3.3	Configuring the communication interface . . . . .	85	12.3	Diagnostic information on local display . . . . .	157
10.3.4	Selecting and setting the medium . . .	87	12.3.1	Diagnostic message . . . . .	157
10.3.5	Displaying the I/O configuration . . . . .	89	12.3.2	Calling up remedial measures . . . . .	159
10.3.6	Configuring the current input . . . . .	89	12.4	Diagnostic information in the Web browser .	160
10.3.7	Configuring the status input . . . . .	91	12.4.1	Diagnostic options . . . . .	160
10.3.8	Configuring the current output . . . . .	92	12.4.2	Calling up remedy information . . . . .	161
10.3.9	Configuring the pulse/frequency/ switch output . . . . .	96			

12.5	Diagnostic information in FieldCare or DeviceCare .....	161	16.3	Input .....	186
12.5.1	Diagnostic options .....	161	16.4	Output .....	189
12.5.2	Calling up remedy information ....	162	16.5	Power supply .....	195
12.6	Diagnostic information via communication interface .....	162	16.6	Performance characteristics .....	196
12.6.1	Reading out diagnostic information	162	16.7	Installation .....	201
12.6.2	Configuring error response mode ...	162	16.8	Environment .....	201
12.7	Adapting the diagnostic information .....	163	16.9	Process .....	202
12.7.1	Adapting the diagnostic behavior ...	163	16.10	Mechanical construction .....	206
12.8	Overview of diagnostic information .....	163	16.11	Human interface .....	210
12.9	Pending diagnostic events .....	168	16.12	Certificates and approvals .....	215
12.10	Diagnostic list .....	169	16.13	Application packages .....	218
12.11	Event logbook .....	170	16.14	Accessories .....	220
12.11.1	Reading out the event logbook .....	170	16.15	Supplementary documentation .....	220
12.11.2	Filtering the event logbook .....	170			
12.11.3	Overview of information events ....	171	<b>Index .....</b>	<b>223</b>	
12.12	Resetting the measuring device .....	172			
12.12.1	Function scope of the "Device reset" parameter .....	172			
12.13	Device information .....	173			
12.14	Firmware history .....	175			
12.15	Device history and compatibility .....	177			
<b>13</b>	<b>Maintenance .....</b>	<b>178</b>			
13.1	Maintenance tasks .....	178			
13.1.1	Exterior cleaning .....	178			
13.1.2	Interior cleaning .....	178			
13.2	Measuring and test equipment .....	178			
13.3	Endress+Hauser services .....	178			
<b>14</b>	<b>Repair .....</b>	<b>179</b>			
14.1	General notes .....	179			
14.1.1	Repair and conversion concept .....	179			
14.1.2	Notes for repair and conversion ....	179			
14.2	Spare parts .....	179			
14.3	Endress+Hauser services .....	179			
14.4	Return .....	179			
14.5	Disposal .....	180			
14.5.1	Removing the measuring device ....	180			
14.5.2	Disposing of the measuring device ..	180			
<b>15</b>	<b>Accessories .....</b>	<b>181</b>			
15.1	Device-specific accessories .....	181			
15.1.1	For the transmitter .....	181			
15.1.2	For the sensor .....	182			
15.2	Service-specific accessories .....	183			
15.3	System components .....	183			
<b>16</b>	<b>Technical data .....</b>	<b>185</b>			
16.1	Application .....	185			
16.2	Function and system design .....	185			

# 1 About this document

## 1.1 Document function

These Operating Instructions contain all the information that is required in various phases of the life cycle of the device: from product identification, incoming acceptance and storage, to mounting, connection, operation and commissioning through to troubleshooting, maintenance and disposal.

## 1.2 Symbols

### 1.2.1 Safety symbols

#### DANGER

This symbol alerts you to a dangerous situation. Failure to avoid this situation will result in serious or fatal injury.

#### WARNING

This symbol alerts you to a dangerous situation. Failure to avoid this situation can result in serious or fatal injury.





#### CAUTION

This symbol alerts you to a dangerous situation. Failure to avoid this situation can result in minor or medium injury.





#### NOTICE

This symbol contains information on procedures and other facts which do not result in personal injury.



### 1.2.2 Electrical symbols

Symbol	Meaning
	Direct current
	Alternating current
	Direct current and alternating current
	<b>Ground connection</b> A grounded terminal which, as far as the operator is concerned, is grounded via a grounding system.
	<b>Protective Earth (PE)</b> A terminal which must be connected to ground prior to establishing any other connections.  The ground terminals are situated inside and outside the device: <ul style="list-style-type: none"> <li>▪ Inner ground terminal: Connects the protective earth to the mains supply.</li> <li>▪ Outer ground terminal: Connects the device to the plant grounding system.</li> </ul>













### 1.2.3 Communication symbols

Symbol	Meaning
	<b>Wireless Local Area Network (WLAN)</b> Communication via a wireless, local network.
	<b>LED</b> Light emitting diode is off.
	<b>LED</b> Light emitting diode is on.
	<b>LED</b> Light emitting diode is flashing.



### 1.2.4 Tool symbols

Symbol	Meaning
	Flat blade screwdriver
	Allen key
	Open-ended wrench

### 1.2.5 Symbols for certain types of information

Symbol	Meaning
	<b>Permitted</b> Procedures, processes or actions that are permitted.
	<b>Preferred</b> Procedures, processes or actions that are preferred.
	<b>Forbidden</b> Procedures, processes or actions that are forbidden.
	<b>Tip</b> Indicates additional information.
	Reference to documentation.
	Reference to page.
	Reference to graphic.
	Notice or individual step to be observed.
	Series of steps.
	Result of a step.
	Help in the event of a problem.
	Visual inspection.

### 1.2.6 Symbols in graphics

Symbol	Meaning
1, 2, 3, ...	Item numbers
<u>1</u> , <u>2</u> , <u>3</u> , ...	Series of steps
A, B, C, ...	Views
A-A, B-B, C-C, ...	Sections
	Hazardous area
	Safe area (non-hazardous area)
	Flow direction

## 1.3 Documentation

 For an overview of the scope of the associated Technical Documentation, refer to the following:

- *W@M Device Viewer* ([www.endress.com/deviceviewer](http://www.endress.com/deviceviewer)): Enter the serial number from nameplate
- *Endress+Hauser Operations App*: Enter the serial number from the nameplate or scan the 2D matrix code (QR code) on the nameplate

 Detailed list of the individual documents along with the documentation code  
→  220

### 1.3.1 Standard documentation

Document type	Purpose and content of the document
Technical Information	<p><b>Planning aid for your device</b></p> <p>The document contains all the technical data on the device and provides an overview of the accessories and other products that can be ordered for the device.</p>
Sensor Brief Operating Instructions	<p><b>Guides you quickly to the 1st measured value - Part 1</b></p> <p>The Sensor Brief Operating Instructions are aimed at specialists with responsibility for installing the measuring device.</p> <ul style="list-style-type: none"> <li>▪ Incoming acceptance and product identification</li> <li>▪ Storage and transport</li> <li>▪ Installation</li> </ul>



Document type	Purpose and content of the document
Transmitter Brief Operating Instructions	<p><b>Guides you quickly to the 1st measured value - Part 2</b>            The Transmitter Brief Operating Instructions are aimed at specialists with responsibility for commissioning, configuring and parameterizing the measuring device (until the first measured value).</p> <ul style="list-style-type: none"> <li>▪ Product description</li> <li>▪ Installation</li> <li>▪ Electrical connection</li> <li>▪ Operation options</li> <li>▪ System integration</li> <li>▪ Commissioning</li> <li>▪ Diagnostic information</li> </ul>
Description of Device Parameters	<p><b>Reference for your parameters</b>            The document provides a detailed explanation of each individual parameter in the Expert operating menu. The description is aimed at those who work with the device over the entire life cycle and perform specific configurations.            The document provides Modbus-specific information for each individual parameter in the Expert operating menu.</p>

### 1.3.2 Supplementary device-dependent documentation

Additional documents are supplied depending on the device version ordered: Always comply strictly with the instructions in the supplementary documentation. The supplementary documentation is an integral part of the device documentation.

## 1.4 Registered trademarks

### Modbus®

Registered trademark of SCHNEIDER AUTOMATION, INC.

### TRI-CLAMP®

Registered trademark of Ladish & Co., Inc., Kenosha, USA

## 2 Safety instructions

### 2.1 Requirements for the personnel

The personnel for installation, commissioning, diagnostics and maintenance must fulfill the following requirements:

- ▶ Trained, qualified specialists must have a relevant qualification for this specific function and task.
- ▶ Are authorized by the plant owner/operator.
- ▶ Are familiar with federal/national regulations.
- ▶ Before starting work, read and understand the instructions in the manual and supplementary documentation as well as the certificates (depending on the application).
- ▶ Follow instructions and comply with basic conditions.

The operating personnel must fulfill the following requirements:

- ▶ Are instructed and authorized according to the requirements of the task by the facility's owner-operator.
- ▶ Follow the instructions in this manual.

### 2.2 Designated use

#### Application and media

The measuring device described in these Operating Instructions is intended only for flow measurement of liquids and gases.

Depending on the version ordered, the measuring device can also measure potentially explosive, flammable, poisonous and oxidizing media.

Measuring devices for use in hazardous areas, in hygienic applications or where there is an increased risk due to process pressure, are labeled accordingly on the nameplate.

To ensure that the measuring device remains in proper condition for the operation time:

- ▶ Keep within the specified pressure and temperature range.
- ▶ Only use the measuring device in full compliance with the data on the nameplate and the general conditions listed in the Operating Instructions and supplementary documentation.
- ▶ Based on the nameplate, check whether the ordered device is permitted for the intended use in the hazardous area (e.g. explosion protection, pressure vessel safety).
- ▶ Use the measuring device only for media to which the process-wetted materials are sufficiently resistant.
- ▶ If the ambient temperature of the measuring device is outside the atmospheric temperature, it is absolutely essential to comply with the relevant basic conditions as specified in the device documentation. →  8
- ▶ Protect the measuring device permanently against corrosion from environmental influences.

#### Incorrect use

Non-designated use can compromise safety. The manufacturer is not liable for damage caused by improper or non-designated use.

**⚠ WARNING****Danger of breakage due to corrosive or abrasive fluids and ambient conditions!**

- ▶ Verify the compatibility of the process fluid with the sensor material.
- ▶ Ensure the resistance of all fluid-wetted materials in the process.
- ▶ Keep within the specified pressure and temperature range.

**NOTICE****Verification for borderline cases:**

- ▶ For special fluids and fluids for cleaning, Endress+Hauser is glad to provide assistance in verifying the corrosion resistance of fluid-wetted materials, but does not accept any warranty or liability as minute changes in the temperature, concentration or level of contamination in the process can alter the corrosion resistance properties.

**Residual risks****⚠ WARNING****The electronics and the medium may cause the surfaces to heat up. This presents a burn hazard!**

- ▶ For elevated fluid temperatures, ensure protection against contact to prevent burns.

**⚠ WARNING****Danger of housing breaking due to measuring tube breakage!**

If a measuring tube ruptures, the pressure inside the sensor housing will rise according to the operating process pressure.

- ▶ Use a rupture disk.

**⚠ WARNING****Danger from medium escaping!**

For device versions with a rupture disk: medium escaping under pressure can cause injury or material damage.

- ▶ Take precautions to prevent injury and material damage if the rupture disk is actuated.

## 2.3 Workplace safety

For work on and with the device:

- ▶ Wear the required personal protective equipment according to federal/national regulations.

For welding work on the piping:

- ▶ Do not ground the welding unit via the measuring device.

If working on and with the device with wet hands:

- ▶ Due to the increased risk of electric shock, gloves must be worn.

## 2.4 Operational safety

Risk of injury.

- ▶ Operate the device in proper technical condition and fail-safe condition only.
- ▶ The operator is responsible for interference-free operation of the device.

### Conversions to the device

Unauthorized modifications to the device are not permitted and can lead to unforeseeable dangers.

- ▶ If, despite this, modifications are required, consult with Endress+Hauser.

### Repair

To ensure continued operational safety and reliability,

- ▶ Carry out repairs on the device only if they are expressly permitted.
- ▶ Observe federal/national regulations pertaining to repair of an electrical device.
- ▶ Use original spare parts and accessories from Endress+Hauser only.

## 2.5 Product safety

This measuring device is designed in accordance with good engineering practice to meet state-of-the-art safety requirements, has been tested, and left the factory in a condition in which it is safe to operate.

It meets general safety standards and legal requirements. It also complies with the EU directives listed in the device-specific EU Declaration of Conformity. Endress+Hauser confirms this by affixing the CE mark to the device.



## 2.6 IT security



Our warranty is valid only if the device is installed and used as described in the Operating Instructions. The device is equipped with security mechanisms to protect it against any inadvertent changes to the settings.

IT security measures, which provide additional protection for the device and associated data transfer, must be implemented by the operators themselves in line with their security standards.

## 2.7 Device-specific IT security

The device offers a range of specific functions to support protective measures on the operator's side. These functions can be configured by the user and guarantee greater in-operation safety if used correctly. An overview of the most important functions is provided in the following section.

Function/interface	Factory setting	Recommendation
Write protection via hardware write protection switch →  13	Not enabled.	On an individual basis following risk assessment.
Access code (also applies for Web server login or FieldCare connection) →  13	Not enabled (0000).	Assign a customized access code during commissioning.
WLAN (order option in display module)	Enabled.	On an individual basis following risk assessment.
WLAN security mode	Enabled (WPA2-PSK)	Do not change.
WLAN passphrase (password) →  13	Serial number	Assign an individual WLAN passphrase during commissioning.
WLAN mode	Access Point	On an individual basis following risk assessment.

Function/interface	Factory setting	Recommendation
Web server →  14	Enabled.	On an individual basis following risk assessment.
CDI-RJ45 service interface →  14	–	On an individual basis following risk assessment.

### 2.7.1 Protecting access via hardware write protection

Write access to the device parameters via the local display, Web browser or operating tool (e.g. FieldCare, DeviceCare) can be disabled via a write protection switch (DIP switch on the motherboard). When hardware write protection is enabled, only read access to the parameters is possible.

Hardware write protection is disabled when the device is delivered →  137.

### 2.7.2 Protecting access via a password

Different passwords are available to protect write access to the device parameters or access to the device via the WLAN interface.

- **User-specific access code**  
Protect write access to the device parameters via the local display, Web browser or operating tool (e.g. FieldCare, DeviceCare). Access authorization is clearly regulated through the use of a user-specific access code.
- **WLAN passphrase**  
The network key protects a connection between an operating unit (e.g. notebook or tablet) and the device via the WLAN interface which can be ordered as an option.
- **Infrastructure mode**  
When the device is operated in infrastructure mode, the WLAN passphrase corresponds to the WLAN passphrase configured on the operator side.

#### User-specific access code

Write access to the device parameters via the local display, Web browser or operating tool (e.g. FieldCare, DeviceCare) can be protected by the modifiable, user-specific access code (→  136).

When the device is delivered, the device does not have an access code and is equivalent to 0000 (open).

#### WLAN passphrase: Operation as WLAN access point

A connection between an operating unit (e.g. notebook or tablet) and the device via the WLAN interface (→  71), which can be ordered as an optional extra, is protected by the network key. The WLAN authentication of the network key complies with the IEEE 802.11 standard.

When the device is delivered, the network key is pre-defined depending on the device. It can be changed via the **WLAN settings** submenu in the **WLAN passphrase** parameter (→  128).

#### Infrastructure mode

A connection between the device and WLAN access point is protected by means of an SSID and passphrase on the system side. Please contact the relevant system administrator for access.

### General notes on the use of passwords



- The access code and network key supplied with the device should be changed during commissioning.
- Follow the general rules for generating a secure password when defining and managing the access code or network key.
- The user is responsible for the management and careful handling of the access code and network key.
- For information on configuring the access code or on what to do if you lose the password, see the "Write protection via access code" section →  136

### 2.7.3 Access via Web server

The device can be operated and configured via a Web browser with the integrated Web server (→  62). The connection is via the service interface (CDI-RJ45) or the WLAN interface.

The Web server is enabled when the device is delivered. The Web server can be disabled if necessary (e.g. after commissioning) via the **Web server functionality** parameter.

The device and status information can be hidden on the login page. This prevents unauthorized access to the information.

 For detailed information on device parameters, see:  
The "Description of Device Parameters" document →  220.

### 2.7.4 Access via service interface (CDI-RJ45)

The device can be connected to a network via the service interface (CDI-RJ45). Device-specific functions guarantee the secure operation of the device in a network.

The use of relevant industrial standards and guidelines that have been defined by national and international safety committees, such as IEC/ISA62443 or the IEEE, is recommended. This includes organizational security measures such as the assignment of access authorization as well as technical measures such as network segmentation.

 Transmitters with an Ex de approval may not be connected via the service interface (CDI-RJ45)!

Order code for "Approval transmitter + sensor", options (Ex de): BA, BB, C1, C2, GA, GB, MA, MB, NA, NB

### 3 Product description

The device consists of a transmitter and a sensor.

The device is available as a compact version:

The transmitter and sensor form a mechanical unit.

#### 3.1 Product design

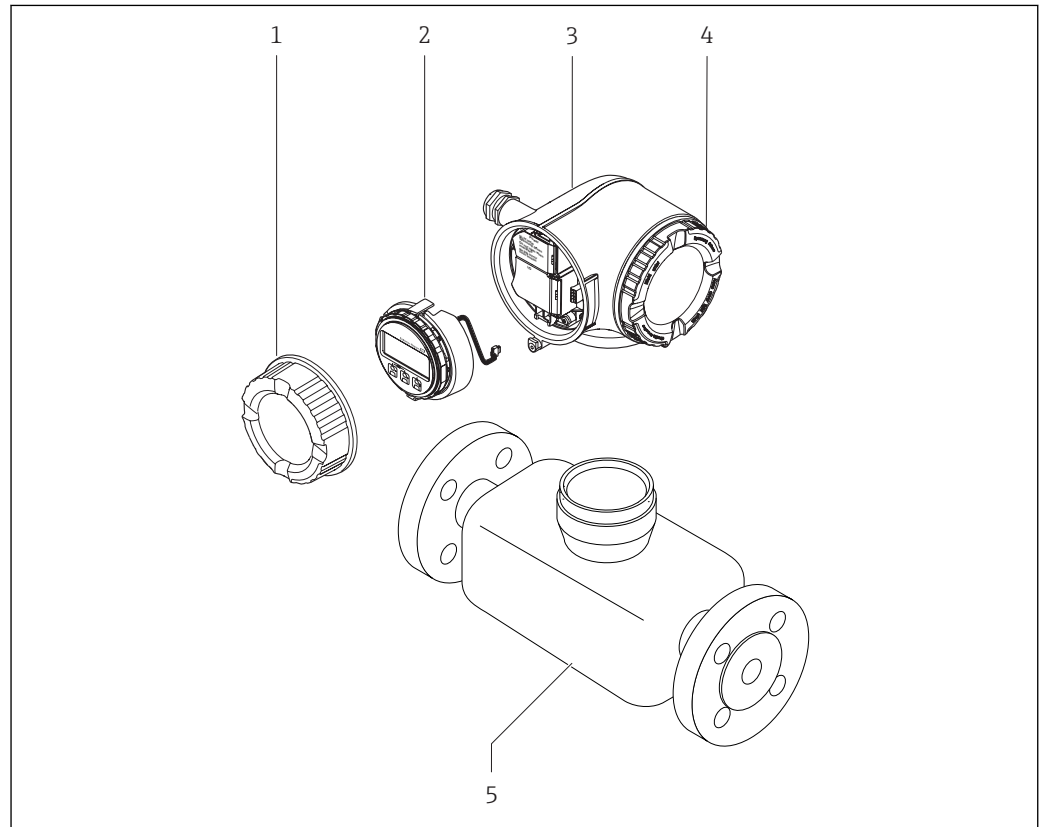

A0029586



#### 1 Important components of a measuring device

- 1 Connection compartment cover
- 2 Display module
- 3 Transmitter housing
- 4 Electronics compartment cover
- 5 Sensor

## 4 Incoming acceptance and product identification

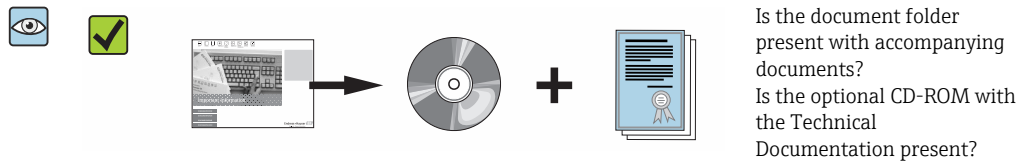
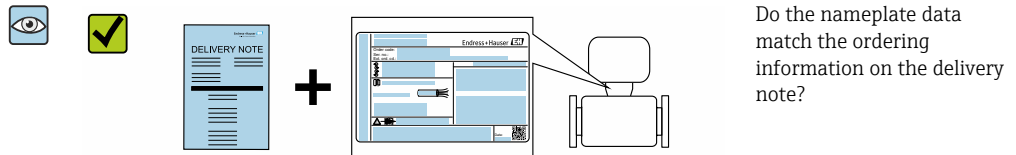
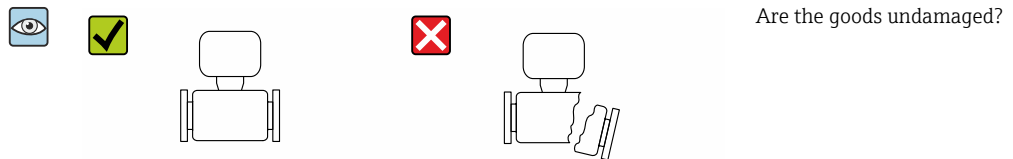
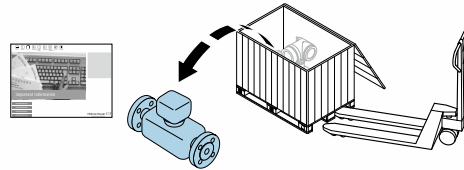
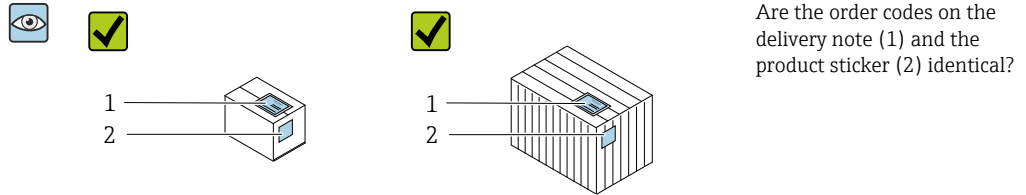
### 4.1 Incoming acceptance



-  ■ If one of the conditions is not satisfied, contact your Endress+Hauser Sales Center.
- Depending on the device version, the CD-ROM might not be part of the delivery! The Technical Documentation is available via the Internet or via the *Endress+Hauser Operations App*, see the "Product identification" section →  17.



## 4.2 Product identification

The following options are available for identification of the device:

- Nameplate specifications
- Order code with breakdown of the device features on the delivery note
- Enter serial numbers from nameplates in the *W@M Device Viewer* ([www.endress.com/deviceviewer](http://www.endress.com/deviceviewer)): All information about the device is displayed.
- Enter the serial number from nameplates in the *Endress+Hauser Operations App* or scan the 2-D matrix code (QR code) on the nameplate using the *Endress+Hauser Operations App*: All information about the device is displayed.

For an overview of the scope of the associated Technical Documentation, refer to the following:

- The "Additional standard documentation on the device" → 8 and "Supplementary device-dependent documentation" → 9 sections
- The *W@M Device Viewer*: enter the serial number from the nameplate ([www.endress.com/deviceviewer](http://www.endress.com/deviceviewer))
- The *Endress+Hauser Operations App*: Enter the serial number from the nameplate or scan the 2-D matrix code (QR code) on the nameplate.

### 4.2.1 Transmitter nameplate

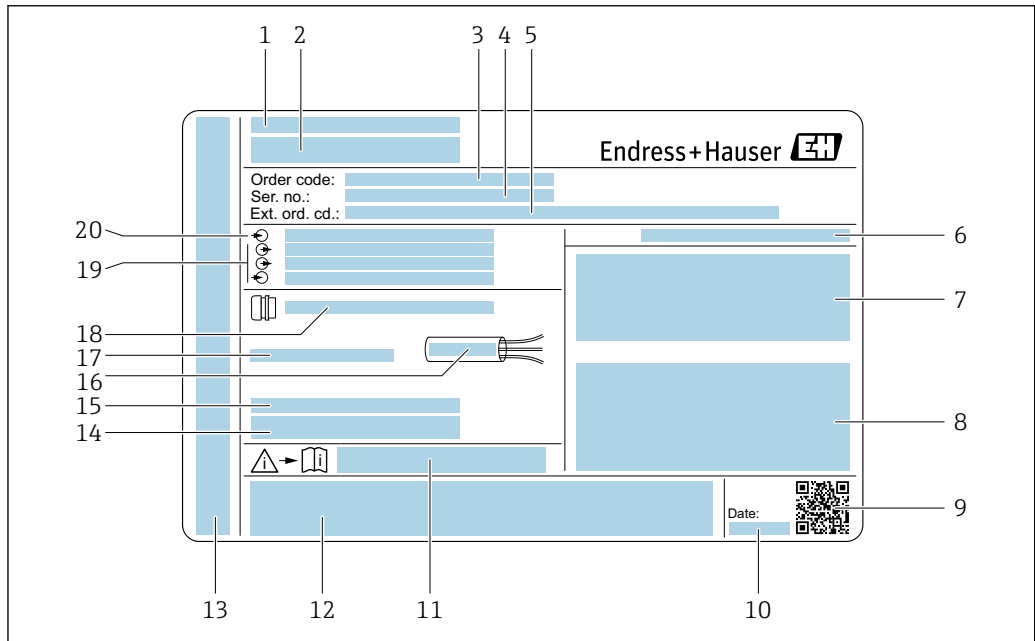

A0029192

2 Example of a transmitter nameplate

- 1 Manufacturing location
- 2 Name of the transmitter
- 3 Order code
- 4 Serial number (ser. no.)
- 5 Extended order code (Ext. ord. cd.)
- 6 Degree of protection
- 7 Space for approvals: use in hazardous areas
- 8 Electrical connection data: available inputs and outputs
- 9 2-D matrix code
- 10 Manufacturing date: year-month
- 11 Document number of safety-related supplementary documentation
- 12 Space for approvals and certificates: e.g. CE mark, C-Tick
- 13 Space for degree of protection of connection and electronics compartment when used in hazardous areas
- 14 Firmware version (FW) and device revision (Dev.Rev.) from the factory
- 15 Space for additional information in the case of special products
- 16 Permitted temperature range for cable
- 17 Permitted ambient temperature ( $T_a$ )
- 18 Information on cable gland
- 19 Available inputs and outputs, supply voltage
- 20 Electrical connection data: supply voltage

### 4.2.2 Sensor nameplate

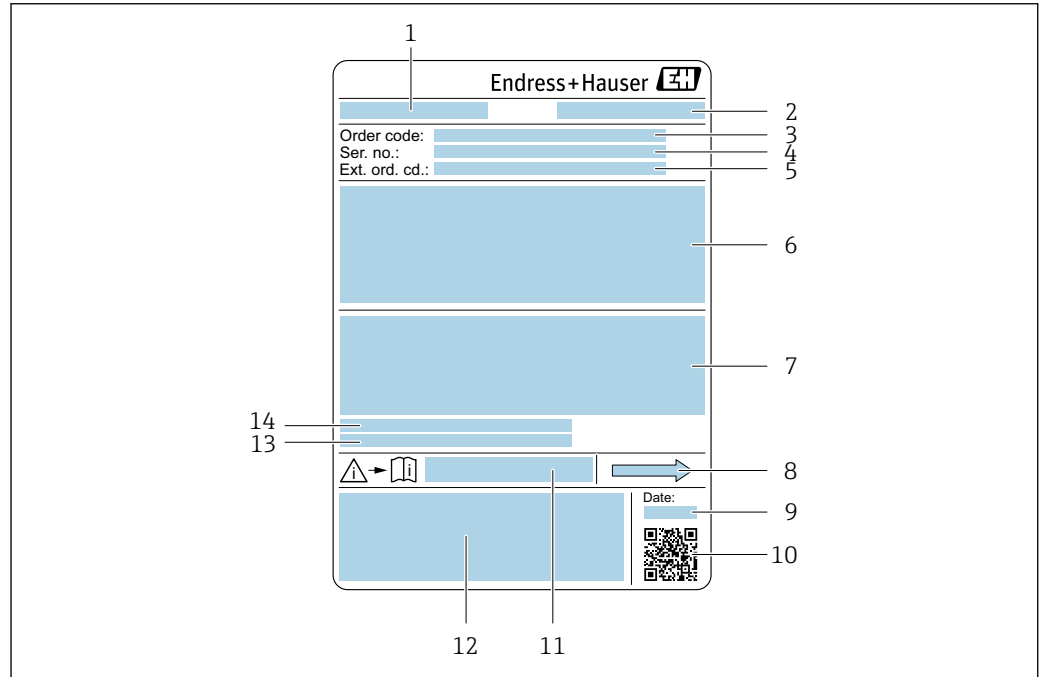

A0029199

3 Example of a sensor nameplate

- 1 Name of the sensor
- 2 Manufacturing location
- 3 Order code
- 4 Serial number (ser. no.)
- 5 Extended order code (Ext. ord. cd.)
- 6 Nominal diameter of the sensor; flange nominal diameter/nominal pressure; sensor test pressure; medium temperature range; material of measuring tube and manifold; sensor-specific information: e.g. pressure range of sensor housing, wide-range density specification (special density calibration)
- 7 Approval information for explosion protection, Pressure Equipment Directive and degree of protection
- 8 Flow direction
- 9 Manufacturing date: year-month
- 10 2-D matrix code
- 11 Document number of safety-related supplementary documentation
- 12 CE mark, C-Tick
- 13 Surface roughness
- 14 Permitted ambient temperature ( $T_a$ )



#### **i** Order code

The measuring device is reordered using the order code.

#### Extended order code

- The device type (product root) and basic specifications (mandatory features) are always listed.
- Of the optional specifications (optional features), only the safety and approval-related specifications are listed (e.g. LA). If other optional specifications are also ordered, these are indicated collectively using the # placeholder symbol (e.g. #LA#).
- If the ordered optional specifications do not include any safety and approval-related specifications, they are indicated by the + placeholder symbol (e.g. XXXXXX-ABCDE +).

### 4.2.3 Symbols on measuring device

Symbol	Meaning
	<b>WARNING!</b> This symbol alerts you to a dangerous situation. Failure to avoid this situation can result in serious or fatal injury.
	<b>Reference to documentation</b> Refers to the corresponding device documentation.
	<b>Protective ground connection</b> A terminal which must be connected to ground prior to establishing any other connections.

## 5 Storage and transport

### 5.1 Storage conditions

Observe the following notes for storage:

- ▶ Store in the original packaging to ensure protection from shock.
- ▶ Do not remove protective covers or protective caps installed on process connections. They prevent mechanical damage to the sealing surfaces and contamination in the measuring tube.
- ▶ Protect from direct sunlight to avoid unacceptably high surface temperatures.
- ▶ Store in a dry and dust-free place.
- ▶ Do not store outdoors.

Storage temperature →  202

### 5.2 Transporting the product

Transport the measuring device to the measuring point in the original packaging.

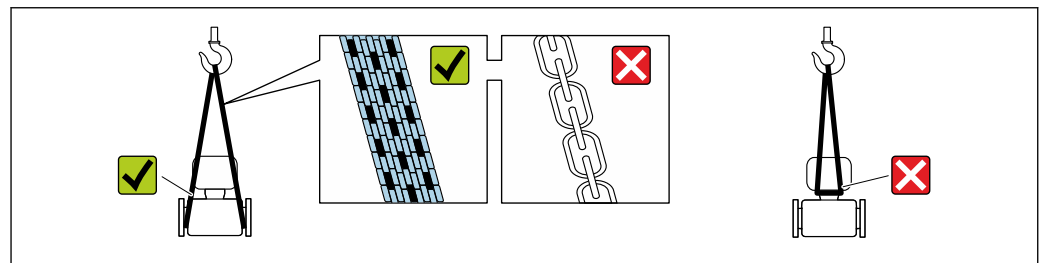

A0029252

 Do not remove protective covers or caps installed on process connections. They prevent mechanical damage to the sealing surfaces and contamination in the measuring tube.

#### 5.2.1 Measuring devices without lifting lugs

##### WARNING

**Center of gravity of the measuring device is higher than the suspension points of the webbing slings.**

Risk of injury if the measuring device slips.

- ▶ Secure the measuring device against slipping or turning.
- ▶ Observe the weight specified on the packaging (stick-on label).

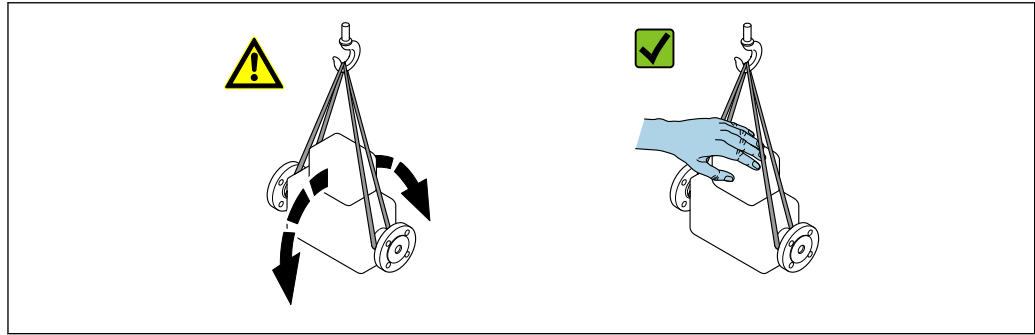

A0029214

### 5.2.2 Measuring devices with lifting lugs

#### ⚠ CAUTION

#### Special transportation instructions for devices with lifting lugs

- ▶ Only use the lifting lugs fitted on the device or flanges to transport the device.
- ▶ The device must always be secured at two lifting lugs at least.

### 5.2.3 Transporting with a fork lift

If transporting in wood crates, the floor structure enables the crates to be lifted lengthwise or at both sides using a forklift.

## 5.3 Packaging disposal

All packaging materials are environmentally friendly and 100 % recyclable:

- Outer packaging of device
  - Polymer stretch wrap that complies with EU Directive 2002/95/EC (RoHS)
- Packaging
  - Wooden crate treated in accordance with ISPM 15 standard, confirmed by IPPC logo
  - Cardboard box in accordance with European packaging guideline 94/62EC, recyclability confirmed by Resy symbol
- Carrying and securing materials
  - Disposable plastic pallet
  - Plastic straps
  - Plastic adhesive strips
- Filler material
  - Paper pads

## 6 Installation

### 6.1 Installation conditions

No special measures such as supports are necessary. External forces are absorbed by the construction of the device.

#### 6.1.1 Mounting position

##### Mounting location

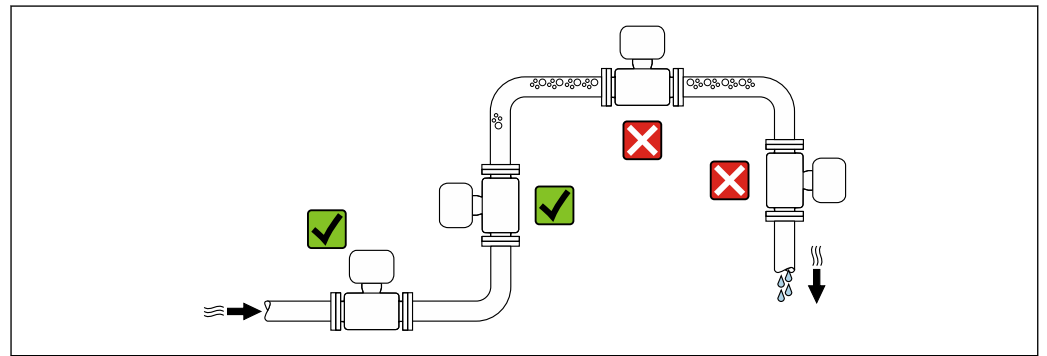

To prevent measuring errors arising from accumulation of gas bubbles in the measuring tube, avoid the following mounting locations in the pipe:

- Highest point of a pipeline.
- Directly upstream of a free pipe outlet in a down pipe.

##### *Installation in down pipes*

However, the following installation suggestion allows for installation in an open vertical pipeline. Pipe restrictions or the use of an orifice with a smaller cross-section than the nominal diameter prevent the sensor running empty while measurement is in progress.

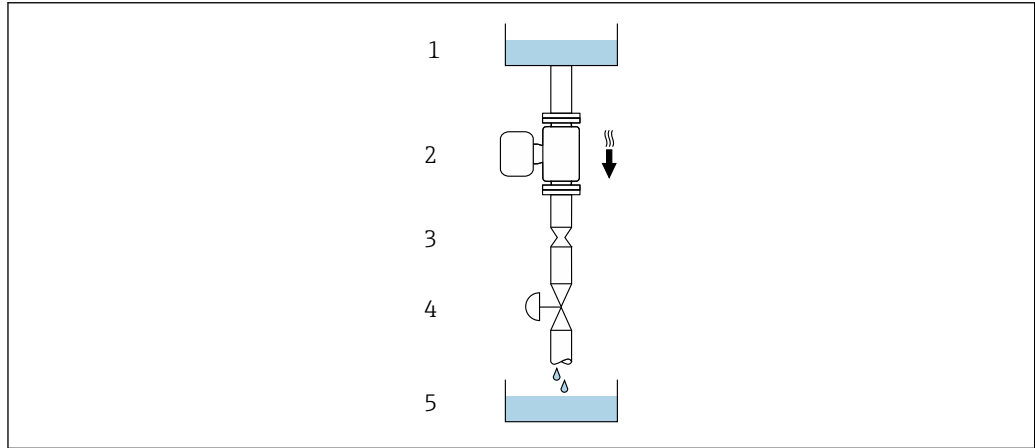

A0028773

4 Installation in a down pipe (e.g. for batching applications)

- 1 Supply tank
- 2 Sensor
- 3 Orifice plate, pipe restriction
- 4 Valve
- 5 Batching tank



DN		Ø orifice plate, pipe restriction	
[mm]	[in]	[mm]	[in]
8	3/8	6	0.24
15	1/2	10	0.40
25	1	14	0.55
40	1½	22	0.87
50	2	28	1.10
80	3	50	1.97
100	4	65	2.60
150	6	90	3.54
250	10	150	5.91

**Orientation**

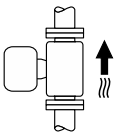
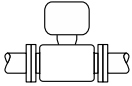
The direction of the arrow on the sensor nameplate helps you to install the sensor according to the flow direction (direction of medium flow through the piping).

Orientation		Recommendation
<b>A</b>	Vertical orientation	 A0015591 ☑☑ <sup>1)</sup>
<b>B</b>	Horizontal orientation, transmitter at top	 A0015589 ☑☑ <sup>2)</sup> Exceptions: → ☑ 5, ☑ 25

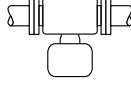

Orientation		Recommendation
C	Horizontal orientation, transmitter at bottom  <small>A0015590</small>	✓✓✓ <sup>3)</sup> Exceptions: → ☒ 5, 📄 25
D	Horizontal orientation, transmitter at side  <small>A0015592</small>	☒

- 1) This orientation is recommended to ensure self-draining.
- 2) Applications with low process temperatures may decrease the ambient temperature. To maintain the minimum ambient temperature for the transmitter, this orientation is recommended.
- 3) Applications with high process temperatures may increase the ambient temperature. To maintain the maximum ambient temperature for the transmitter, this orientation is recommended.

If a sensor is installed horizontally with a curved measuring tube, match the position of the sensor to the fluid properties.

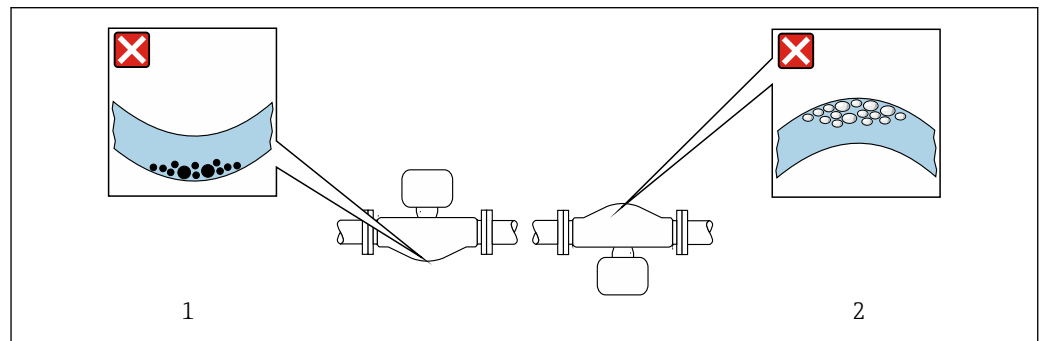

☒ 5 Orientation of sensor with curved measuring tube

- 1 Avoid this orientation for fluids with entrained solids: Risk of solids accumulating.
- 2 Avoid this orientation for outgassing fluids: Risk of gas accumulating.

**Inlet and outlet runs**

No special precautions need to be taken for fittings which create turbulence, such as valves, elbows or T-pieces, as long as no cavitation occurs → 📄 26.

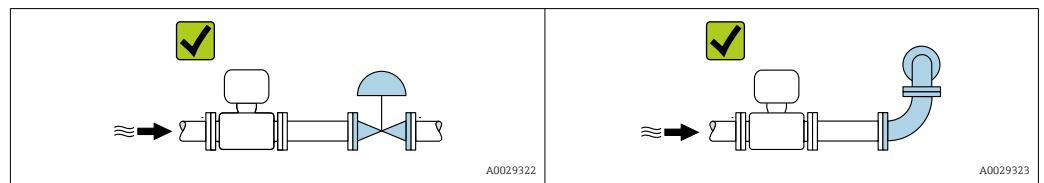



*Installation dimensions*

📄 For the dimensions and installation lengths of the device, see the "Technical Information" document, "Mechanical construction" section.



## 6.1.2 Environment and process requirements

### Ambient temperature range

Measuring device	<ul style="list-style-type: none"> <li>■ -40 to +60 °C (-40 to +140 °F)</li> <li>■ Order code for "Test, certificate", option JP: -50 to +60 °C (-58 to +140 °F)</li> </ul>
Readability of the local display	-20 to +60 °C (-4 to +140 °F) The readability of the display may be impaired at temperatures outside the temperature range.

 Dependency of ambient temperature on medium temperature →  202

- ▶ If operating outdoors:  
Avoid direct sunlight, particularly in warm climatic regions.

 You can order a weather protection cover from Endress+Hauser. →  181.

### System pressure

It is important that cavitation does not occur, or that gases entrained in the liquids do not outgas.

Cavitation is caused if the pressure drops below the vapor pressure:

- In liquids that have a low boiling point (e.g. hydrocarbons, solvents, liquefied gases)
  - In suction lines
- ▶ Ensure the system pressure is sufficiently high to prevent cavitation and outgassing.

For this reason, the following mounting locations are recommended:

- At the lowest point in a vertical pipe
- Downstream from pumps (no danger of vacuum)

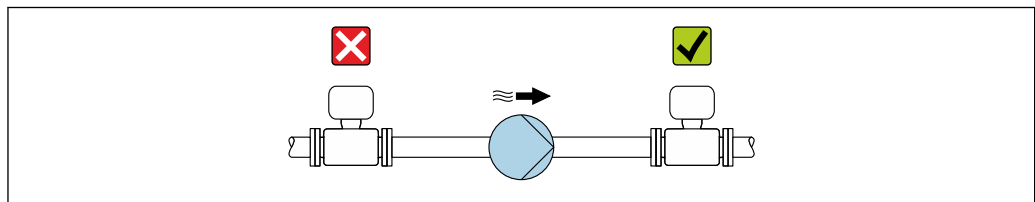

A0028777

### Thermal insulation

In the case of some fluids, it is important to keep the heat radiated from the sensor to the transmitter to a low level. A wide range of materials can be used for the required insulation.

The following device versions are recommended for versions with thermal insulation:

- Version with extended neck for insulation:  
Order code for "Sensor option", option CG with an extended neck length of 105 mm (4.13 in).
- Extended temperature version:  
Order code for "Measuring tube material", option SD, SE, SF or TH with an extended neck length of 105 mm (4.13 in).
- High-temperature version:  
Order code for "Measuring tube material", option TS, TT or TU with an extended neck length of 142 mm (5.59 in).

#### NOTICE

##### Electronics overheating on account of thermal insulation!

- ▶ Recommended orientation: horizontal orientation, transmitter housing pointing downwards.
- ▶ Do not insulate the transmitter housing .
- ▶ Maximum permissible temperature at the lower end of the transmitter housing: 80 °C (176 °F)
- ▶ Thermal insulation with extended neck free: We recommend that you do not insulate the extended neck in order to ensure optimum dissipation of heat.

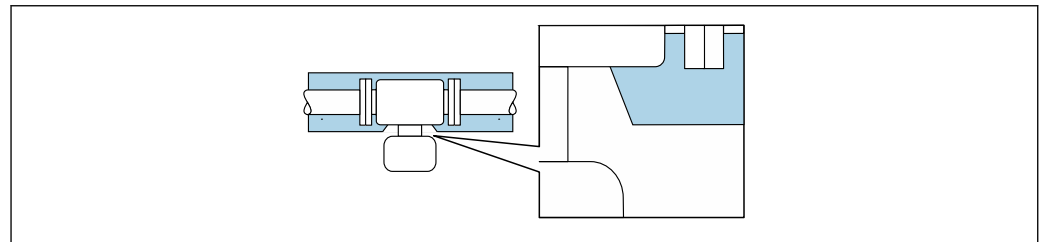

6 Thermal insulation with extended neck free

- ▶ **i** Low-temperature version: It is generally not necessary to insulate the transmitter housing . If insulation is provided, the rules that apply are the same as those for thermal insulation.

## Heating

#### NOTICE

##### Electronics can overheat due to elevated ambient temperature!

- ▶ Observe maximum permitted ambient temperature for the transmitter .
- ▶ Depending on the fluid temperature, take the device orientation requirements into account .

#### NOTICE

##### Danger of overheating when heating

- ▶ Ensure that the temperature at the lower end of the transmitter housing does not exceed 80 °C (176 °F).
- ▶ Ensure that sufficient convection takes place at the transmitter neck.
- ▶ Ensure that a sufficiently large area of the transmitter neck remains exposed. The uncovered part serves as a radiator and protects the electronics from overheating and excessive cooling.
- ▶ When using in potentially explosive atmospheres, observe the information in the device-specific Ex documentation. For detailed information on the temperature tables, see the separate document entitled "Safety Instructions" (XA) for the device.

### Heating options

If a fluid requires that no heat loss should occur at the sensor, users can avail of the following heating options:

- Electrical heating, e.g. with electric band heaters
- Via pipes carrying hot water or steam
- Via heating jackets

### Vibrations

The high oscillation frequency of the measuring tubes ensures that the correct operation of the measuring system is not influenced by plant vibrations.

## 6.1.3 Special mounting instructions

### Drainability

The measuring tubes can be completely drained and protected against solids build-up in vertical orientation.

### Sanitary compatibility

 When installing in hygienic applications, please refer to the information in the "Certificates and approvals/hygienic compatibility" section →  216.

### Rupture disk

Information that is relevant to the process: →  205.

### **WARNING**

#### **Danger from medium escaping!**

Medium escaping under pressure can cause injury or material damage.

- ▶ Take precautions to prevent danger to persons and damage if the rupture disk is actuated.
- ▶ Observe information on the rupture disk sticker.
- ▶ Make sure that the function and operation of the rupture disk is not impeded through the installation of the device.
- ▶ Do not use a heating jacket.
- ▶ Do not remove or damage the rupture disk.

The position of the rupture disk is indicated on a sticker beside it.

The transportation guard must be removed.

The existing connecting nozzles are not intended for the purpose of rinsing or pressure monitoring, but instead serve as the mounting location for the rupture disk.

In the event of a failure of the rupture disk, a discharge device can be screwed onto the internal thread of the rupture disk in order to drain off any escaping medium.

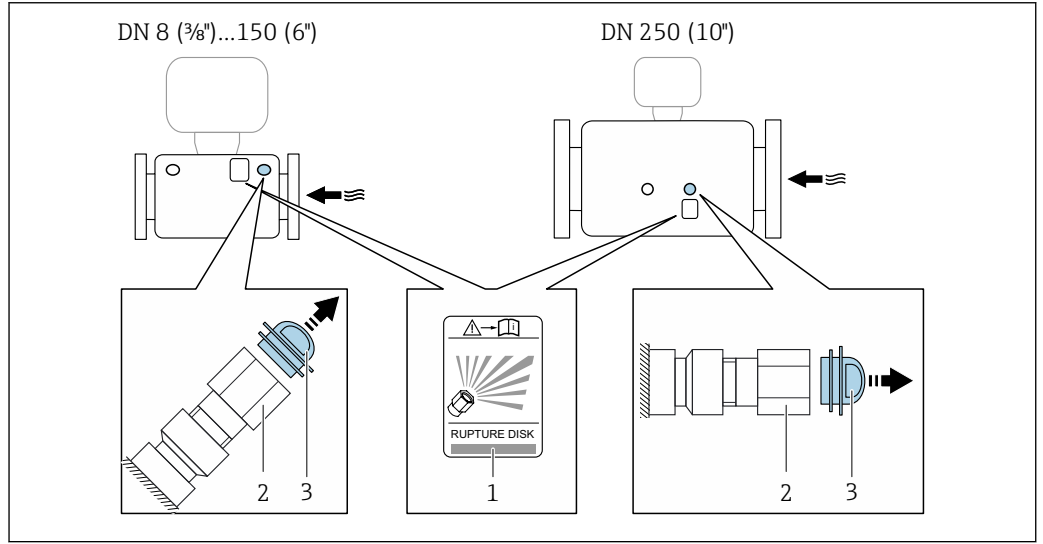

A0028903

- 1 Rupture disk label
- 2 Rupture disk with 1/2" NPT internal thread with 1" width across flat
- 3 Transportation guard

 For information on the dimensions: see the "Mechanical construction" section of the "Technical Information" document

**Zero point adjustment**

All measuring devices are calibrated in accordance with state-of-the-art technology. Calibration takes place under reference conditions → 196. Therefore, a zero point adjustment in the field is generally not required.

Experience shows that zero point adjustment is advisable only in special cases:

- To achieve maximum measuring accuracy even with low flow rates.
- Under extreme process or operating conditions (e.g. very high process temperatures or very high-viscosity fluids).

**Protective cover**

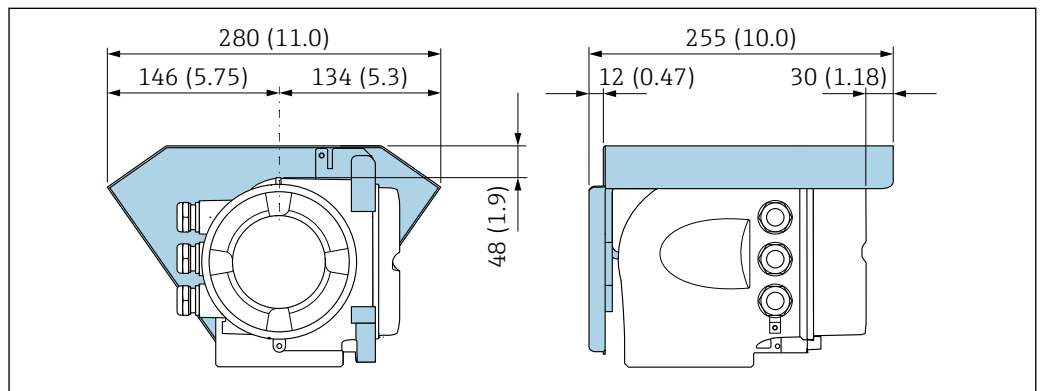

A0029553

### Cover locking

#### NOTICE

Order code for "Housing", option L "Cast, stainless": The covers of the transmitter housing are provided with a borehole to lock the cover.

The cover can be locked using screws and a chain or cable provided by the customer.

- ▶ It is recommended to use stainless steel cables or chains.
- ▶ If a protective coating is applied, it is recommended to use a heat shrink tube to protect the housing paint.

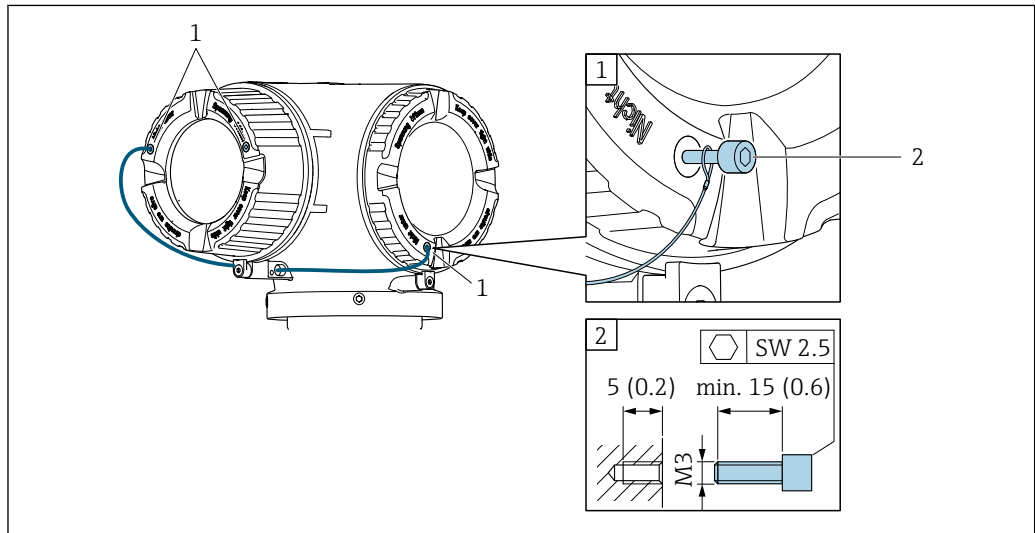

A0029800

- 1 Cover borehole for the securing screw  
2 Securing screw to lock the cover

## 6.2 Mounting the measuring device

### 6.2.1 Required tools

#### For sensor

For flanges and other process connections: Corresponding mounting tools

### 6.2.2 Preparing the measuring device

1. Remove all remaining transport packaging.
2. Remove any protective covers or protective caps present from the sensor.
3. Remove stick-on label on the electronics compartment cover.

### 6.2.3 Mounting the measuring device

#### ⚠ WARNING

**Danger due to improper process sealing!**

- ▶ Ensure that the inside diameters of the gaskets are greater than or equal to that of the process connections and piping.
- ▶ Ensure that the gaskets are clean and undamaged.
- ▶ Install the gaskets correctly.

1. Ensure that the direction of the arrow on the nameplate of the sensor matches the flow direction of the fluid.
2. Install the measuring device or turn the transmitter housing so that the cable entries do not point upwards.

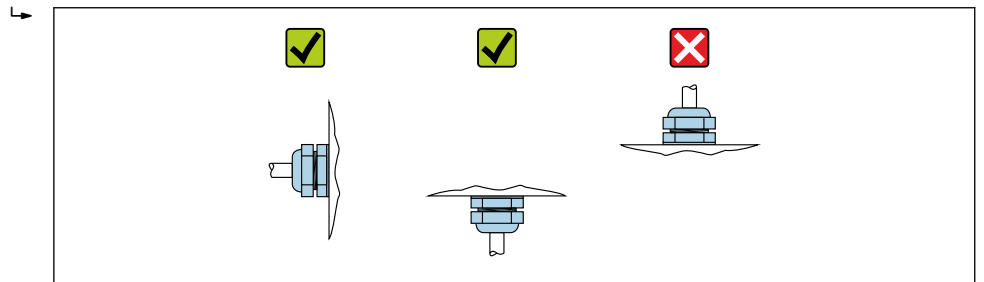

A0029263

### 6.2.4 Turning the transmitter housing

To provide easier access to the connection compartment or display module, the transmitter housing can be turned.

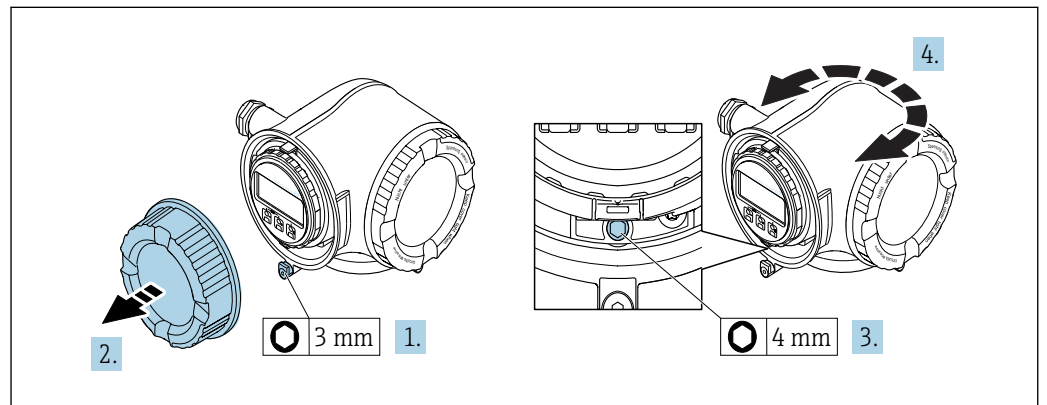

A0029993

1. Depending on the device version: Loosen the securing clamp of the connection compartment cover.
2. Unscrew the connection compartment cover.
3. Release the fixing screw.
4. Turn the housing to the desired position.
5. Firmly tighten the securing screw.
6. Screw on the connection compartment cover
7. Depending on the device version: Attach the securing clamp of the connection compartment cover.

### 6.2.5 Turning the display module

The display module can be turned to optimize display readability and operability.

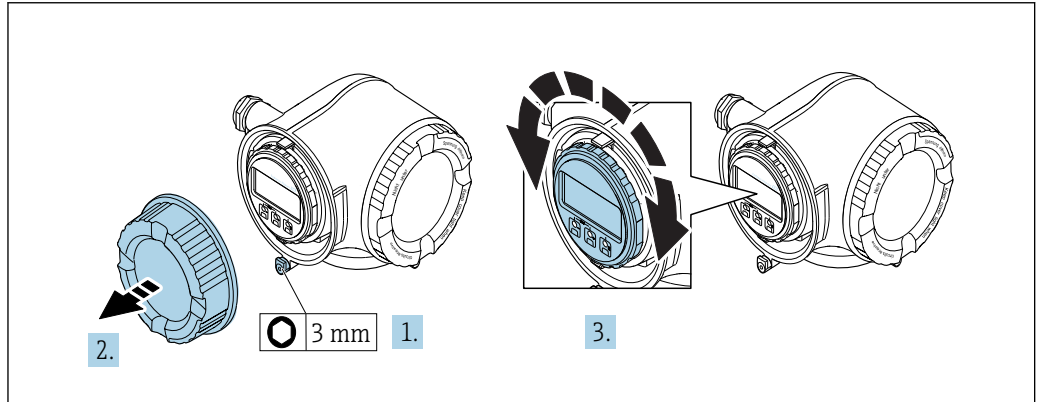

A0030035

1. Depending on the device version: Loosen the securing clamp of the connection compartment cover.
2. Unscrew the connection compartment cover.
3. Turn the display module to the desired position: max.  $8 \times 45^\circ$  in each direction.
4. Screw on the connection compartment cover.
5. Depending on the device version: Attach the securing clamp of the connection compartment cover.

### 6.3 Post-installation check

Is the device undamaged (visual inspection)?	<input type="checkbox"/>
Does the measuring device conform to the measuring point specifications? For example: <ul style="list-style-type: none"> <li>▪ Process temperature → ☰ 202</li> <li>▪ Process pressure (refer to the section on "Pressure-temperature ratings" in the "Technical Information" document)</li> <li>▪ Ambient temperature</li> <li>▪ Measuring range</li> </ul>	<input type="checkbox"/>
Has the correct orientation for the sensor been selected ? <ul style="list-style-type: none"> <li>▪ According to sensor type</li> <li>▪ According to medium temperature</li> <li>▪ According to medium properties (outgassing, with entrained solids)</li> </ul>	<input type="checkbox"/>
Does the arrow on the sensor nameplate match the direction of flow of the fluid through the piping → ☰ 24?	<input type="checkbox"/>
Are the measuring point identification and labeling correct (visual inspection)?	<input type="checkbox"/>
Is the device adequately protected from precipitation and direct sunlight?	<input type="checkbox"/>
Are the securing screw and securing clamp tightened securely?	<input type="checkbox"/>



## 7 Electrical connection

### NOTICE

The measuring device does not have an internal circuit breaker.

- ▶ For this reason, assign the measuring device a switch or power-circuit breaker so that the power supply line can be easily disconnected from the mains.
- ▶ Although the measuring device is equipped with a fuse, additional overcurrent protection (maximum 10 A) should be integrated into the system installation.

### 7.1 Connection conditions

#### 7.1.1 Required tools

- For cable entries: Use corresponding tools
- For securing clamp: Allen key 3 mm
- Wire stripper
- When using stranded cables: Crimper for wire end ferrule
- For removing cables from terminal: Flat blade screwdriver  $\leq 3$  mm (0.12 in)

#### 7.1.2 Requirements for connecting cable

The connecting cables provided by the customer must fulfill the following requirements.

##### Electrical safety

In accordance with applicable federal/national regulations.

##### Protective ground cable

Cable  $\geq 2.08$  mm<sup>2</sup> (14 AWG)

The grounding impedance must be less than 1  $\Omega$ .

##### Permitted temperature range

- The installation guidelines that apply in the country of installation must be observed.
- The cables must be suitable for the minimum and maximum temperatures to be expected.

##### Power supply cable

Standard installation cable is sufficient.

##### Signal cable

*Modbus RS485*

The EIA/TIA-485 standard specifies two types of cable (A and B) for the bus line which can be used for every transmission rate. Cable type A is recommended.

Cable type	A
Characteristic impedance	135 to 165 $\Omega$ at a measuring frequency of 3 to 20 MHz
Cable capacitance	< 30 pF/m
Wire cross-section	> 0.34 mm <sup>2</sup> (22 AWG)

<b>Cable type</b>	Twisted pairs
<b>Loop resistance</b>	$\leq 110 \Omega/\text{km}$
<b>Signal damping</b>	Max. 9 dB over the entire length of the cable cross-section
<b>Shield</b>	Copper braided shielding or braided shielding with foil shield. When grounding the cable shield, observe the grounding concept of the plant.

*Current output 0/4 to 20 mA*

Standard installation cable is sufficient.

*Pulse/frequency/switch output*

Standard installation cable is sufficient.

*Double pulse output*

Standard installation cable is sufficient.

*Relay output*

Standard installation cable is sufficient.

*Current input 0/4 to 20 mA*

Standard installation cable is sufficient.

*Status input*

Standard installation cable is sufficient.

#### **Cable diameter**

- Cable glands supplied:  
M20 × 1.5 with cable  $\varnothing$  6 to 12 mm (0.24 to 0.47 in)
- Spring-loaded terminals: Suitable for strands and strands with ferrules.  
Conductor cross-section 0.2 to 2.5 mm<sup>2</sup> (24 to 12 AWG).

#### **Requirements for the connecting cable – Remote display and operating module DKX001**

*Optionally available connecting cable*

A cable is supplied depending on the order option

- Order code for measuring device: order code **030** for "Display; operation", option **O** or
- Order code for measuring device: order code **030** for "Display; operation", option **M** and
- Order code for DKX001: order code **040** for "Cable", option **A, B, D, E**

<b>Standard cable</b>	$2 \times 2 \times 0.34 \text{ mm}^2$ (22 AWG) PVC cable with common shield (2 pairs, pair-stranded)
<b>Flame resistance</b>	According to DIN EN 60332-1-2
<b>Oil-resistance</b>	According to DIN EN 60811-2-1
<b>Shielding</b>	Tin-plated copper-braid, optical cover $\geq 85 \%$
<b>Capacitance: core/shield</b>	$\leq 200 \text{ pF/m}$
<b>L/R</b>	$\leq 24 \mu\text{H}/\Omega$

<b>Available cable length</b>	5 m (15 ft)/10 m (35 ft)/20 m (65 ft)/30 m (100 ft)
<b>Operating temperature</b>	When mounted in a fixed position: -50 to +105 °C (-58 to +221 °F); when cable can move freely: -25 to +105 °C (-13 to +221 °F)

#### *Standard cable - customer-specific cable*

No cable is supplied, and it must be provided by the customer (up to max. 300 m (1 000 ft)) for the following order option:

Order code for DKX001: Order code **040** for "Cable", option **1** "None, provided by customer, max 300 m"

A standard cable can be used as the connecting cable.

<b>Standard cable</b>	4 cores (2 pairs); pair-stranded with common shield
<b>Shielding</b>	Tin-plated copper-braid, optical cover ≥ 85 %
<b>Capacitance: core/shield</b>	Maximum 1 000 nF for Zone 1, Class I, Division 1
<b>L/R</b>	Maximum 24 µH/Ω for Zone 1, Class I, Division 1
<b>Cable length</b>	Maximum 300 m (1 000 ft), see the following table



<b>Cross-section</b>	<b>Max. cable length for use in Non-hazardous area, Ex Zone 2, Class I, Division 2 Ex Zone 1, Class I, Division 1</b>
0.34 mm <sup>2</sup> (22 AWG)	80 m (270 ft)
0.50 mm <sup>2</sup> (20 AWG)	120 m (400 ft)
0.75 mm <sup>2</sup> (18 AWG)	180 m (600 ft)
1.00 mm <sup>2</sup> (17 AWG)	240 m (800 ft)
1.50 mm <sup>2</sup> (15 AWG)	300 m (1 000 ft)

### 7.1.3 Terminal assignment

#### Transmitter: supply voltage, input/outputs

The terminal assignment of the inputs and outputs depends on the individual order version of the device. The device-specific terminal assignment is documented on an adhesive label in the terminal cover.

Supply voltage		Input/output 1		Input/output 2		Input/output 3	
1 (+)	2 (-)	26 (B)	27 (A)	24 (+)	25 (-)	22 (+)	23 (-)
Device-specific terminal assignment: adhesive label in terminal cover.							

 Terminal assignment of the remote display and operating module →  40.

### 7.1.4 Shielding and grounding

#### Shielding and grounding concept

1. Maintain electromagnetic compatibility (EMC).
2. Take explosion protection into consideration.
3. Pay attention to the protection of persons.
4. Comply with national installation regulations and guidelines.
5. Observe cable specifications .
6. Keep the stripped and twisted lengths of cable shield to the ground terminal as short as possible.
7. Shield cables fully.

#### Grounding of the cable shield

##### NOTICE

**In systems without potential matching, the multiple grounding of the cable shield causes mains frequency equalizing currents!**

Damage to the bus cable shield.

- ▶ Only ground the bus cable shield to either the local ground or the protective ground at one end.
- ▶ Insulate the shield that is not connected.

To comply with EMC requirements:

1. Ensure the cable shield is grounded to the potential matching line at multiple points.
2. Connect every local ground terminal to the potential matching line.

### 7.1.5 Preparing the measuring device

##### NOTICE

**Insufficient sealing of the housing!**

Operational reliability of the measuring device could be compromised.

- ▶ Use suitable cable glands corresponding to the degree of protection.

1. Remove dummy plug if present.

2. If the measuring device is supplied without cable glands:  
Provide suitable cable gland for corresponding connecting cable.
3. If the measuring device is supplied with cable glands:  
Observe requirements for connecting cables → 33.

## 7.2 Connecting the measuring device

### NOTICE

#### Limitation of electrical safety due to incorrect connection!

- ▶ Have electrical connection work carried out by appropriately trained specialists only.
- ▶ Observe applicable federal/national installation codes and regulations.
- ▶ Comply with local workplace safety regulations.
- ▶ Always connect the protective ground cable ⊕ before connecting additional cables.
- ▶ For use in potentially explosive atmospheres, observe the information in the device-specific Ex documentation.

### 7.2.1 Connecting the transmitter

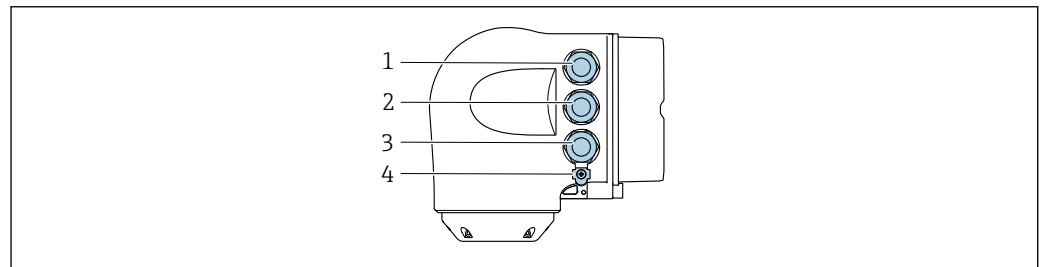

A0026781

- 1 Terminal connection for supply voltage
- 2 Terminal connection for signal transmission, input/output
- 3 Terminal connection for signal transmission, input/output or terminal connection for network connection via service interface (CDI-RJ45); optional: connection for external WLAN antenna or remote display and operating module DKX001
- 4 Protective earth (PE)

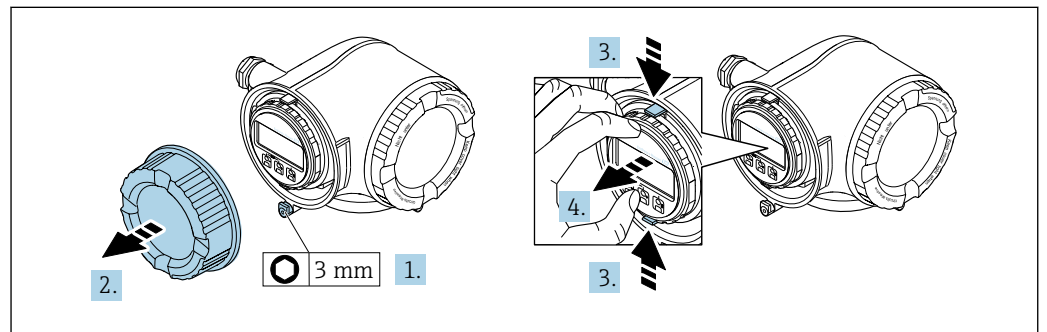

A0029813

1. Loosen the securing clamp of the connection compartment cover.
2. Unscrew the connection compartment cover.
3. Squeeze the tabs of the display module holder together.
4. Remove the display module holder.

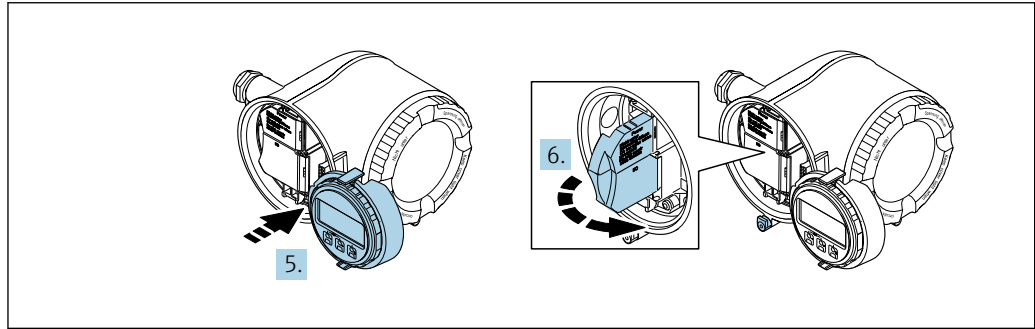

A0029814

5. Attach the holder to the edge of the electronics compartment.
6. Open the terminal cover.

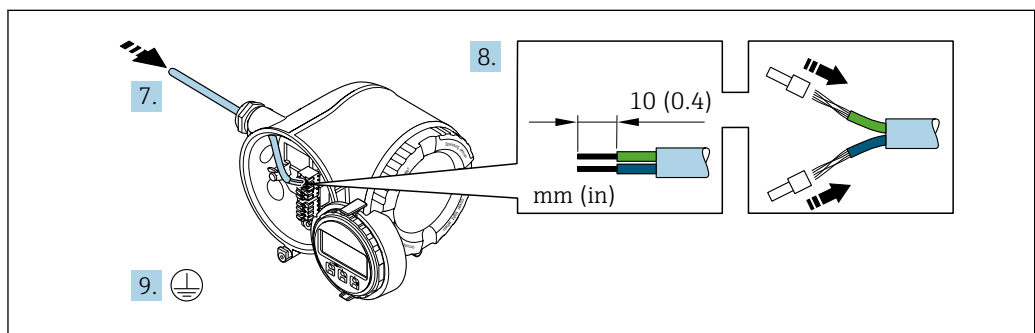

A0029815

7. Push the cable through the cable entry . To ensure tight sealing, do not remove the sealing ring from the cable entry.
8. Strip the cable and cable ends. In the case of stranded cables, also fit ferrules.
9. Connect the protective ground.

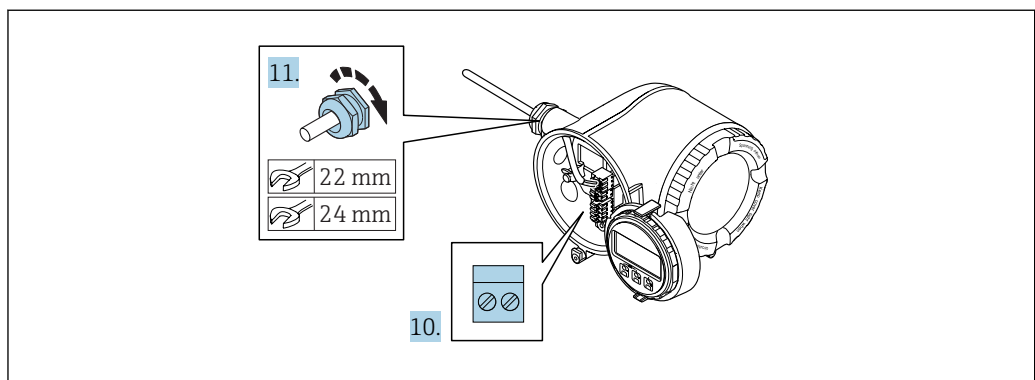

A0029816

10. Connect the cable in accordance with the terminal assignment .
  - ↳ **Signal cable terminal assignment:** The device-specific terminal assignment is documented on an adhesive label in the terminal cover.
  - Supply voltage terminal assignment:** Adhesive label in the terminal cover or → 36.
11. Firmly tighten the cable glands.
  - ↳ This concludes the cable connection process.
12. Close the terminal cover.

13. Fit the display module holder in the electronics compartment.
14. Screw on the connection compartment cover.
15. Secure the securing clamp of the connection compartment cover.

### Removing a cable

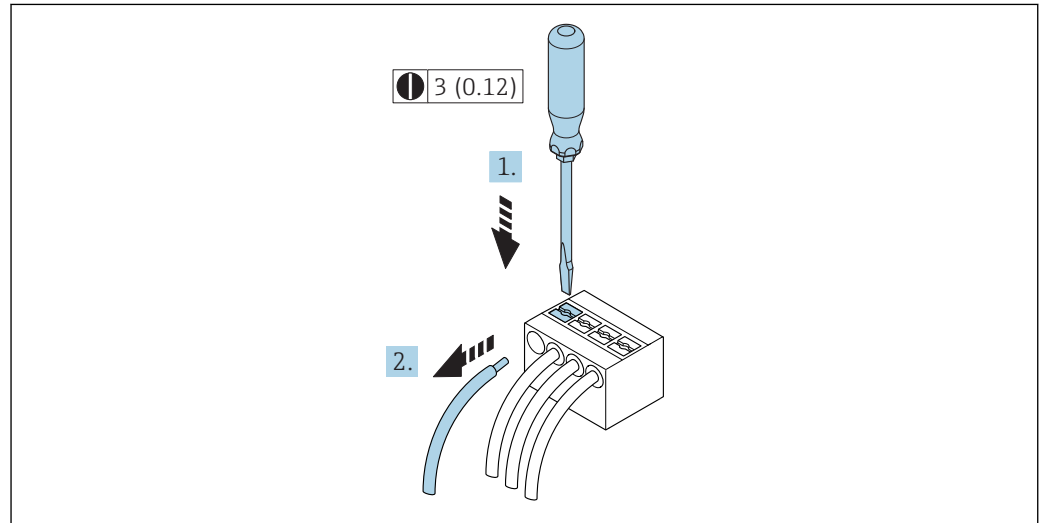

A0029598

7 Engineering unit mm (in)

1. To remove a cable from the terminal, use a flat-blade screwdriver to push the slot between the two terminal holes
2. while simultaneously pulling the cable end out of the terminal.

## 7.2.2 Connecting the remote display and operating module DKX001

**i** The remote display and operating module DKX001 is available as an optional extra → 181.

- The remote display and operating module DKX001 is only available for the following housing versions, order code for "Housing":
  - Option A "Aluminum, coated"
  - Option L "Cast, stainless"
- The measuring device is always supplied with a dummy cover when the remote display and operating module DKX001 is ordered directly with the measuring device. Display or operation at the transmitter is not possible in this case.
- If ordered subsequently, the remote display and operating module DKX001 may not be connected at the same time as the existing measuring device display module. Only one display or operation unit may be connected to the transmitter at any one time.

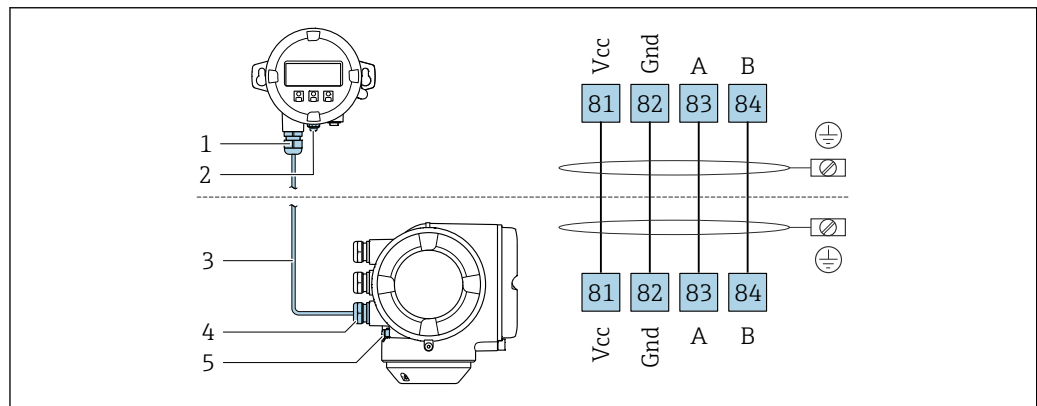

A0027518

- 1 Remote display and operating module DKX001
- 2 Protective earth (PE)
- 3 Connecting cable
- 4 Measuring device
- 5 Protective earth (PE)

## 7.3 Ensuring potential equalization

### 7.3.1 Requirements

No special measures for potential equalization are required.



## 7.4 Special connection instructions

### 7.4.1 Connection examples

#### Modbus RS485

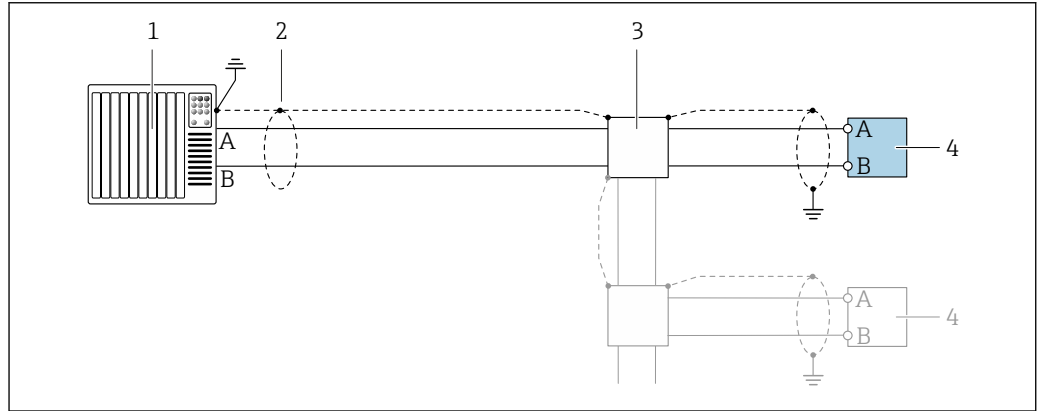

A0028765

8 Connection example for Modbus RS485, non-hazardous area and Zone 2; Class I, Division 2

- 1 Control system (e.g. PLC)
- 2 Cable shield provided at one end. The cable shield must be grounded at both ends to comply with EMC requirements; observe cable specifications
- 3 Distribution box
- 4 Transmitter

#### Current output 4-20 mA

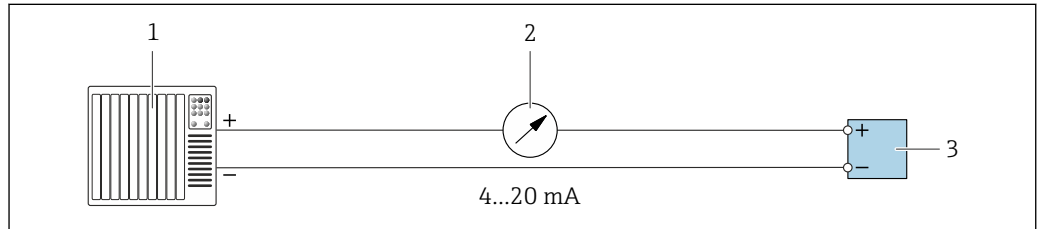

A0028758

9 Connection example for 4-20 mA current output (active)

- 1 Automation system with current input (e.g. PLC)
- 2 Analog display unit: observe maximum load
- 3 Transmitter

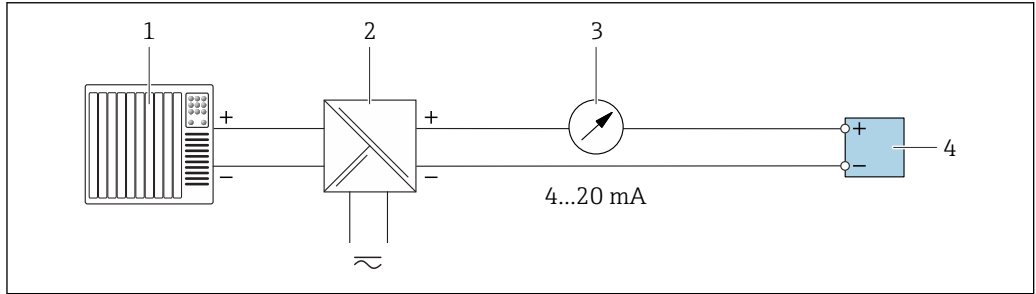

A0028759

10 Connection example for 4-20 mA current output (passive)

- 1 Automation system with current input (e.g. PLC)
- 2 Active barrier for power supply (e.g. RN221N)
- 3 Analog display unit: observe maximum load
- 4 Transmitter

**Pulse/frequency output**

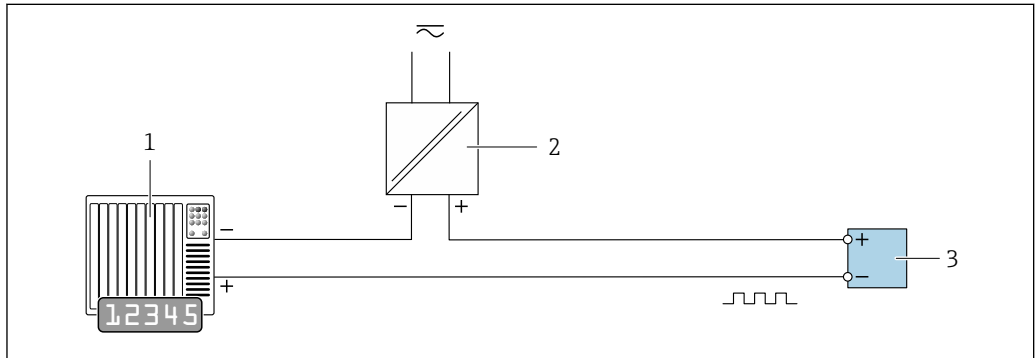

A0028761

11 Connection example for pulse/frequency output (passive)

- 1 Automation system with pulse/frequency input (e.g. PLC)
- 2 Power supply
- 3 Transmitter: Observe input values → 189

**Switch output**

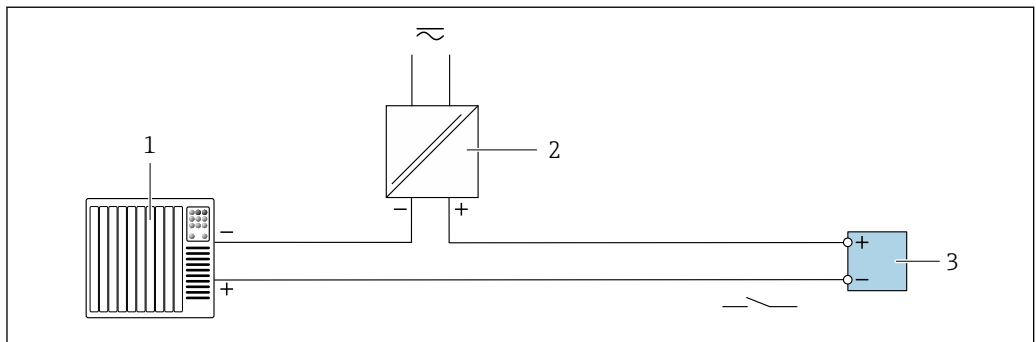

A0028760

12 Connection example for switch output (passive)

- 1 Automation system with switch input (e.g. PLC)
- 2 Power supply
- 3 Transmitter: Observe input values → 189

### Double pulse output

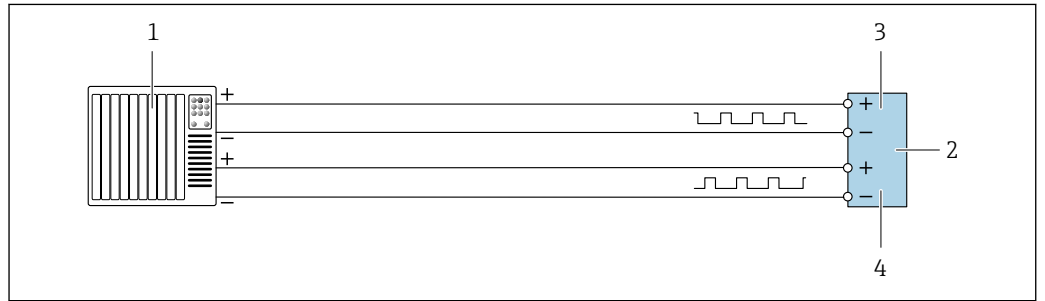

A0029280

13 Connection example for double pulse output (active)

- 1 Automation system with double pulse input (e.g. PLC)
- 2 Transmitter: Observe input values → 191
- 3 Double pulse output
- 4 Double pulse output (slave), phase-shifted

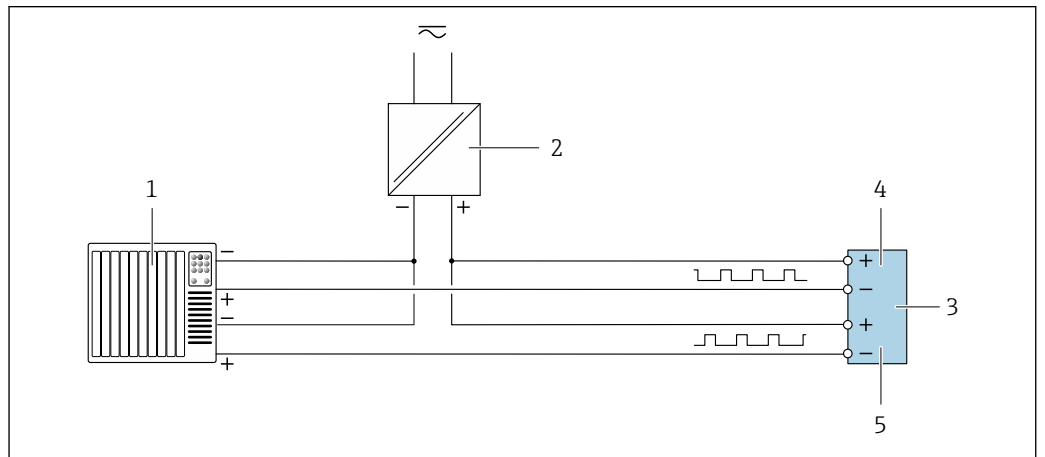

A0029279

14 Connection example for double pulse output (passive)

- 1 Automation system with double pulse input (e.g. PLC)
- 2 Power supply
- 3 Transmitter: Observe input values → 191
- 4 Double pulse output
- 5 Double pulse output (slave), phase-shifted

### Relay output

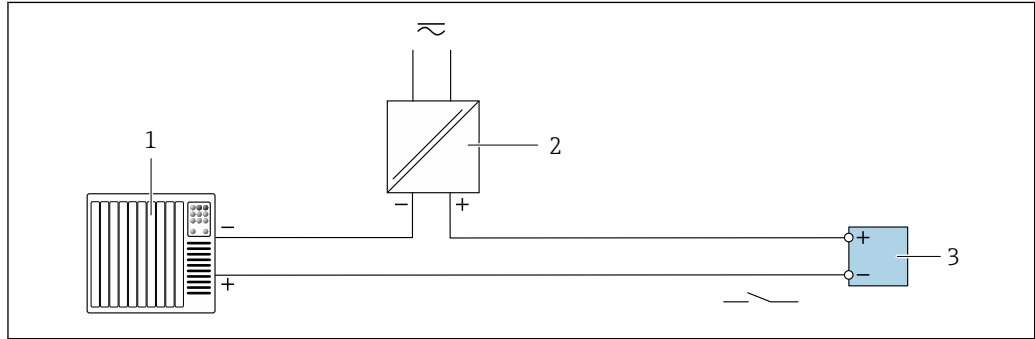

A0028760

15 Connection example for relay output (passive)

- 1 Automation system with relay input (e.g. PLC)
- 2 Power supply
- 3 Transmitter: Observe input values → 191

### Current input

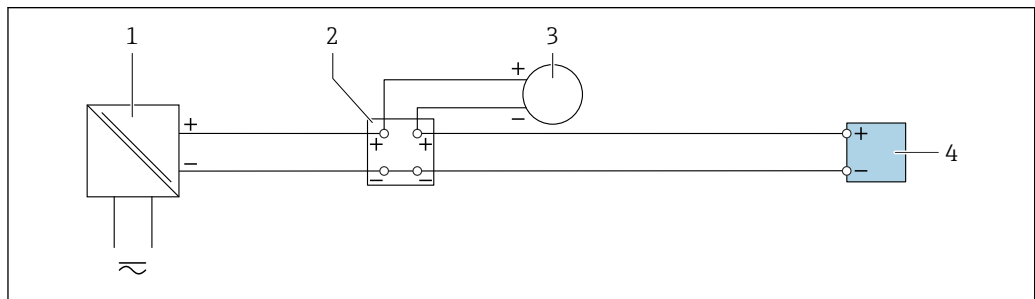

A0028915

16 Connection example for 4 to 20 mA current input

- 1 Power supply
- 2 Terminal box
- 3 External measuring device (to read in pressure or temperature, for instance)
- 4 Transmitter

### Status input

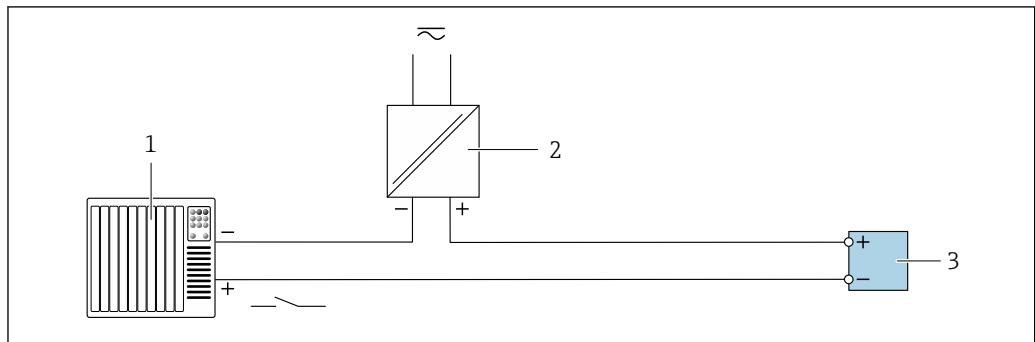

A0028764

17 Connection example for status input

- 1 Automation system with status output (e.g. PLC)
- 2 Power supply
- 3 Transmitter

## 7.5 Hardware settings

### 7.5.1 Setting the device address

The device address must always be configured for a Modbus slave. The valid device addresses are in the range from 1 to 247. Each address may only be assigned once in a Modbus RS485 network. If an address is not configured correctly, the measuring device is not recognized by the Modbus master. All measuring devices are delivered from the factory with the device address 247 and with the "software addressing" address mode.

#### Hardware addressing

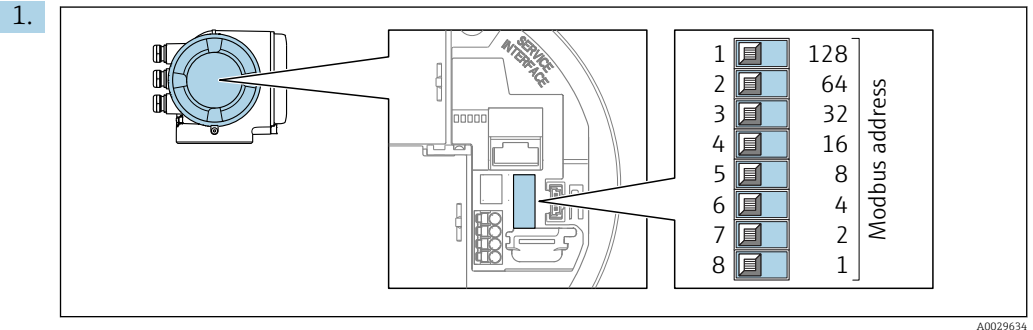

Set the desired device address using the DIP switches in the connection compartment.

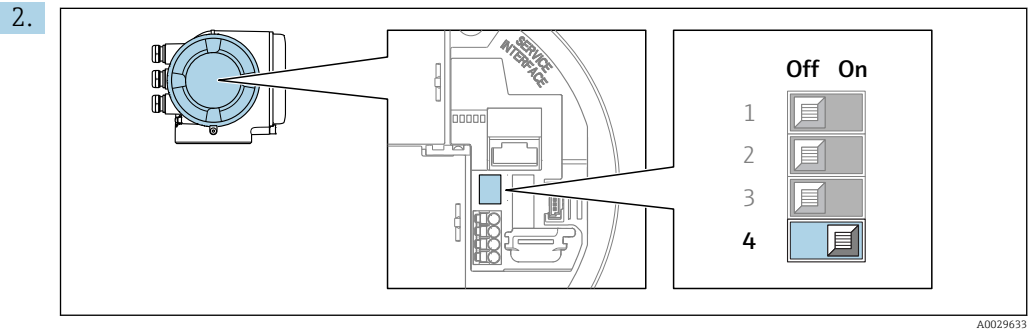

To switch addressing from software addressing to hardware addressing: set the DIP switch to **On**.

↳ The change of device address takes effect after 10 seconds.

#### Software addressing

► To switch addressing from hardware addressing to software addressing: set the DIP switch to **Off**.

↳ The device address configured in the **Device address** parameter takes effect after 10 seconds.

### 7.5.2 Enabling the terminating resistor

To avoid incorrect communication transmission caused by impedance mismatch, terminate the Modbus RS485 cable correctly at the start and end of the bus segment.

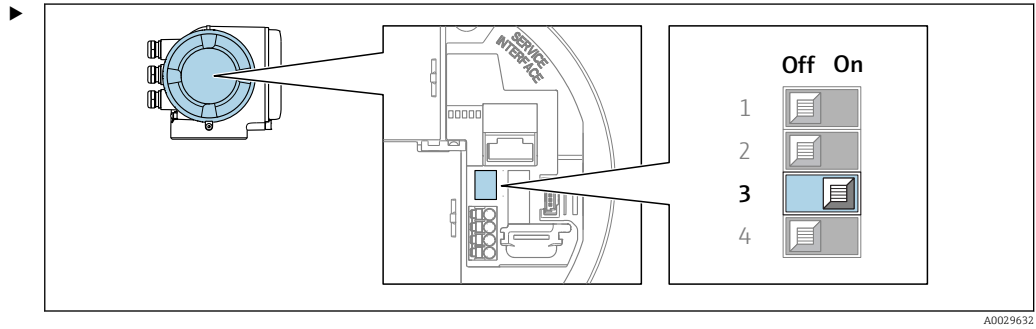

Switch DIP switch No. 3 to **On**.

### 7.6 Ensuring the degree of protection

The measuring device fulfills all the requirements for the IP66/67 degree of protection, Type 4X enclosure.

To guarantee IP66/67 degree of protection, Type 4X enclosure, carry out the following steps after the electrical connection:

1. Check that the housing seals are clean and fitted correctly.
2. Dry, clean or replace the seals if necessary.
3. Tighten all housing screws and screw covers.
4. Firmly tighten the cable glands.
5. To ensure that moisture does not enter the cable entry:  
Route the cable so that it loops down before the cable entry ("water trap").

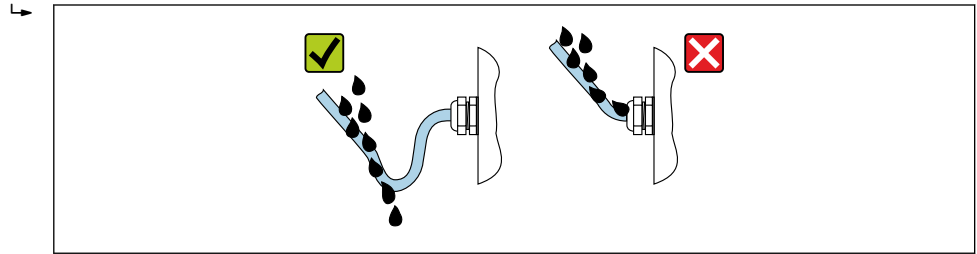

6. Insert dummy plugs into unused cable entries.

### 7.7 Post-connection check

Are cables or the device undamaged (visual inspection)?	<input type="checkbox"/>
Do the cables used meet the requirements?	<input type="checkbox"/>
Do the cables have adequate strain relief?	<input type="checkbox"/>
Are all the cable glands installed, firmly tightened and leak-tight? Cable run with "water trap" → 46?	<input type="checkbox"/>
If supply voltage is present, do values appear on the display module?	<input type="checkbox"/>

## 8 Operation options

### 8.1 Overview of operation options

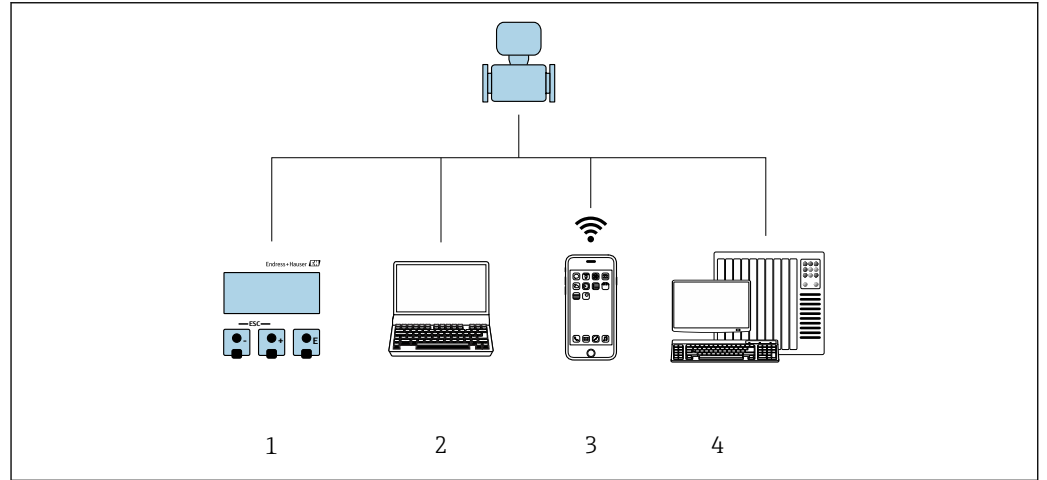

A0030213

- 1 Local operation via display module
- 2 Computer with Web browser (e.g. Internet Explorer) or with operating tool (e.g. FieldCare, DeviceCare, AMS Device Manager, SIMATIC PDM)
- 3 Mobile handheld terminal with Wireless Field Device Configurator App
- 4 Control system (e.g. PLC)

## 8.2 Structure and function of the operating menu

### 8.2.1 Structure of the operating menu



For an overview of the operating menu for experts: "Description of Device Parameters" document supplied with the device →  220



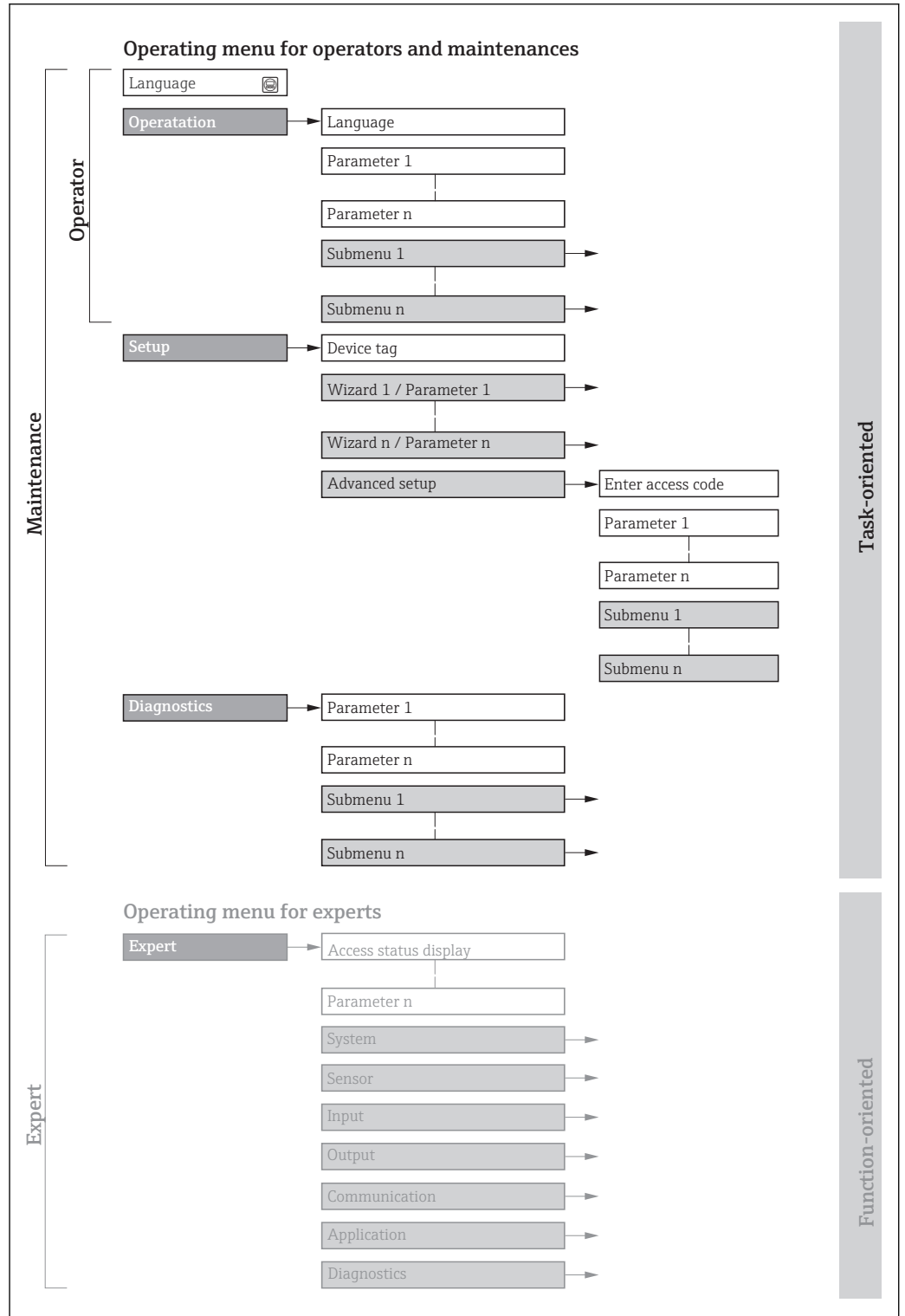

18 Schematic structure of the operating menu

A0018237-EN

### 8.2.2 Operating philosophy

The individual parts of the operating menu are assigned to certain user roles (operator, maintenance etc.). Each user role contains typical tasks within the device lifecycle.

 For custody transfer, once the device has been put into circulation or sealed, its operation is restricted.

Menu/parameter		User role and tasks	Content/meaning
Language	task-oriented	<b>Role "Operator", "Maintenance"</b> Tasks during operation: <ul style="list-style-type: none"> <li>▪ Configuring the operational display</li> <li>▪ Reading measured values</li> </ul>	<ul style="list-style-type: none"> <li>▪ Defining the operating language</li> <li>▪ Defining the Web server operating language</li> <li>▪ Resetting and controlling totalizers</li> </ul>
Operation			<ul style="list-style-type: none"> <li>▪ Configuring the operational display (e.g. display format, display contrast)</li> <li>▪ Resetting and controlling totalizers</li> </ul>
Setup		<b>"Maintenance" role</b> Commissioning: <ul style="list-style-type: none"> <li>▪ Configuration of the measurement</li> <li>▪ Configuration of the inputs and outputs</li> <li>▪ Configuration of the communication interface</li> </ul>	Wizards for fast commissioning: <ul style="list-style-type: none"> <li>▪ Setting the system units</li> <li>▪ Configuration of the communication interface</li> <li>▪ Defining the medium</li> <li>▪ Displaying the I/O/configuration</li> <li>▪ Configuring the inputs</li> <li>▪ Configuring the outputs</li> <li>▪ Configuration of the operational display</li> <li>▪ Setting the low flow cut off</li> <li>▪ Configuring partial and empty pipe detection</li> </ul> Advanced setup <ul style="list-style-type: none"> <li>▪ For more customized configuration of the measurement (adaptation to special measuring conditions)</li> <li>▪ Configuration of totalizers</li> <li>▪ Configuring the WLAN settings</li> <li>▪ Administration (define access code, reset measuring device)</li> </ul>
Diagnostics		<b>"Maintenance" role</b> Fault elimination: <ul style="list-style-type: none"> <li>▪ Diagnostics and elimination of process and device errors</li> <li>▪ Measured value simulation</li> </ul>	Contains all parameters for error detection and analyzing process and device errors: <ul style="list-style-type: none"> <li>▪ Diagnostic list Contains up to 5 currently pending diagnostic messages.</li> <li>▪ Event logbook Contains event messages that have occurred.</li> <li>▪ Device information Contains information for identifying the device.</li> <li>▪ Measured values Contains all current measured values.</li> <li>▪ <b>Data logging</b> submenu with "Extended HistoROM" order option Storage and visualization of measured values</li> <li>▪ Heartbeat The functionality of the device is checked on demand and the verification results are documented.</li> <li>▪ Simulation Is used to simulate measured values or output values.</li> </ul>

Menu/parameter		User role and tasks	Content/meaning
Expert	function-oriented	<p>Tasks that require detailed knowledge of the function of the device:</p> <ul style="list-style-type: none"> <li>▪ Commissioning measurements under difficult conditions</li> <li>▪ Optimal adaptation of the measurement to difficult conditions</li> <li>▪ Detailed configuration of the communication interface</li> <li>▪ Error diagnostics in difficult cases</li> </ul>	<p>Contains all the parameters of the device and makes it possible to access these parameters directly using an access code. The structure of this menu is based on the function blocks of the device:</p> <ul style="list-style-type: none"> <li>▪ System Contains all higher-order device parameters which do not concern the measurement or the communication interface.</li> <li>▪ Sensor Configuration of the measurement.</li> <li>▪ Input Configuration of the status input.</li> <li>▪ Output Configuration of the analog current outputs as well as the pulse/frequency and switch output.</li> <li>▪ Communication Configuration of the digital communication interface and the Web server.</li> <li>▪ Application Configuration of the functions that go beyond the actual measurement (e.g. totalizer).</li> <li>▪ Diagnostics Error detection and analysis of process and device errors and for device simulation and Heartbeat Technology.</li> </ul>

### 8.3 Access to the operating menu via the local display

#### 8.3.1 Operational display

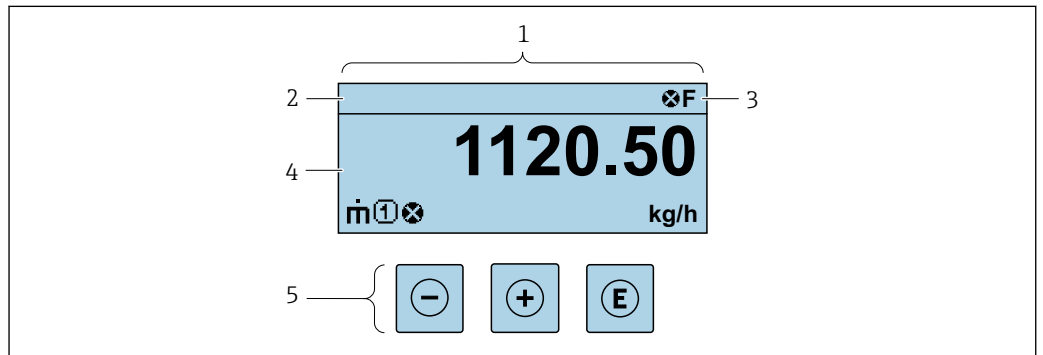





A0029348

- 1 Operational display
- 2 Device tag
- 3 Status area
- 4 Display area for measured values (4-line)
- 5 Operating elements → 57

### Status area

The following symbols appear in the status area of the operational display at the top right:







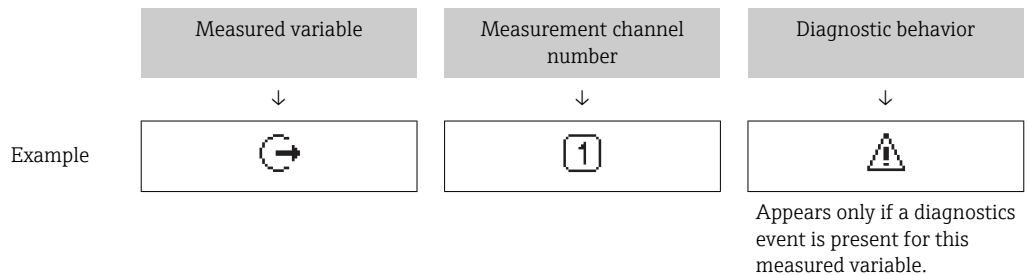

- Status signals → ⓘ 157
  - **F**: Failure
  - **C**: Function check
  - **S**: Out of specification
  - **M**: Maintenance required
- Diagnostic behavior → ⓘ 158
  - : Alarm
  - : Warning
  - : Locking (the device is locked via the hardware )
  - : Communication (communication via remote operation is active)

### Display area

In the display area, each measured value is prefaced by certain symbol types for further description:



### Measured values

Symbol	Meaning
	Mass flow
	<ul style="list-style-type: none"> <li>▪ Volume flow</li> <li>▪ Corrected volume flow</li> </ul>
	<ul style="list-style-type: none"> <li>▪ Density</li> <li>▪ Reference density</li> </ul>
	Temperature
	Totalizer  The measurement channel number indicates which of the three totalizers is displayed.
	Output  The measurement channel number indicates which of the outputs is displayed.
	Status input

Measurement channel numbers

Symbol	Meaning
	Measurement channel 1 to 4
The measurement channel number is displayed only if more than one channel is present for the same measured variable type (e.g. Totalizer 1 to 3).	

Diagnostic behavior

The diagnostic behavior pertains to a diagnostic event that is relevant to the displayed measured variable. For information on the symbols → 158

The number and display format of the measured values can be configured via the **Format display** parameter (→ 111).



8.3.2 Navigation view

In the submenu	In the wizard
A0013993-EN	A0013995-EN
<p>1 Navigation view                  2 Navigation path to current position                  3 Status area                  4 Display area for navigation                  5 Operating elements →  57</p>	

Navigation path

The navigation path - displayed at the top left in the navigation view - consists of the following elements:



	<ul style="list-style-type: none"> <li>In the submenu: Display symbol for menu</li> <li>In the wizard: Display symbol for wizard</li> </ul>	Omission symbol for operating menu levels in between	Name of current <ul style="list-style-type: none"> <li>Submenu</li> <li>Wizard</li> <li>Parameters</li> </ul>
	↓	↓	↓
Examples		/.. /	Display
		/.. /	Display

 For more information about the icons in the menu, refer to the "Display area" section →  54

### Status area





The following appears in the status area of the navigation view in the top right corner:

- In the submenu
  - The direct access code for the parameter you are navigating to (e.g. 0022-1)
  - If a diagnostic event is present, the diagnostic behavior and status signal
- In the wizard
  - If a diagnostic event is present, the diagnostic behavior and status signal





-  ▪ For information on the diagnostic behavior and status signal →  157
- For information on the function and entry of the direct access code →  60

### Display area

#### Menus

Symbol	Meaning
	<b>Operation</b> Appears: <ul style="list-style-type: none"> <li>▪ In the menu next to the "Operation" selection</li> <li>▪ At the left in the navigation path in the <b>Operation</b> menu</li> </ul>
	<b>Setup</b> Appears: <ul style="list-style-type: none"> <li>▪ In the menu next to the "Setup" selection</li> <li>▪ At the left in the navigation path in the <b>Setup</b> menu</li> </ul>
	<b>Diagnostics</b> Appears: <ul style="list-style-type: none"> <li>▪ In the menu next to the "Diagnostics" selection</li> <li>▪ At the left in the navigation path in the <b>Diagnostics</b> menu</li> </ul>
	<b>Expert</b> Appears: <ul style="list-style-type: none"> <li>▪ In the menu next to the "Expert" selection</li> <li>▪ At the left in the navigation path in the <b>Expert</b> menu</li> </ul>



#### Submenus, wizards, parameters

Symbol	Meaning
	Submenu
	Wizard
	Parameters within a wizard  No display symbol exists for parameters in submenus.

#### Locking

Symbol	Meaning
	<b>Parameter locked</b> When displayed in front of a parameter name, indicates that the parameter is locked. <ul style="list-style-type: none"> <li>▪ By a user-specific access code</li> <li>▪ By the hardware write protection switch</li> </ul>

*Wizard operation*

Symbol	Meaning
	Switches to the previous parameter.
	Confirms the parameter value and switches to the next parameter.
	Opens the editing view of the parameter.

### 8.3.3 Editing view

**Numeric editor**

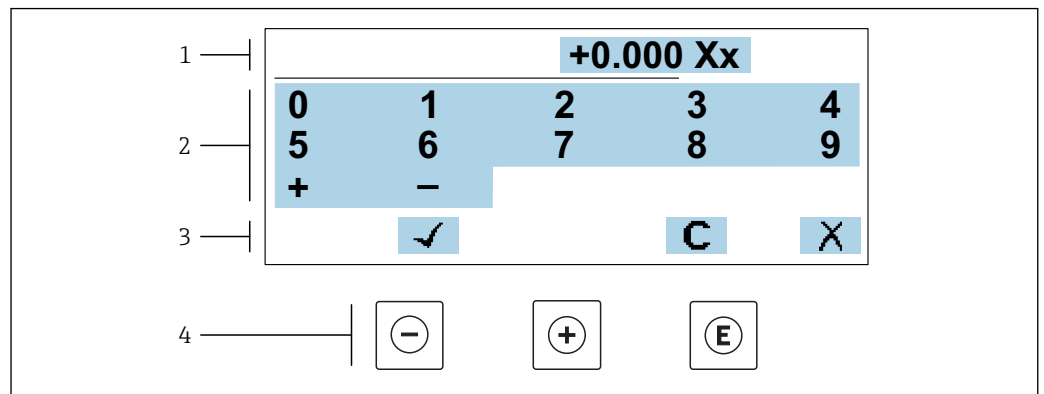

A0034250

19 For entering values in parameters (e.g. limit values)

- 1 Entry display area
- 2 Input screen
- 3 Confirm, delete or reject entry
- 4 Operating elements

**Text editor**

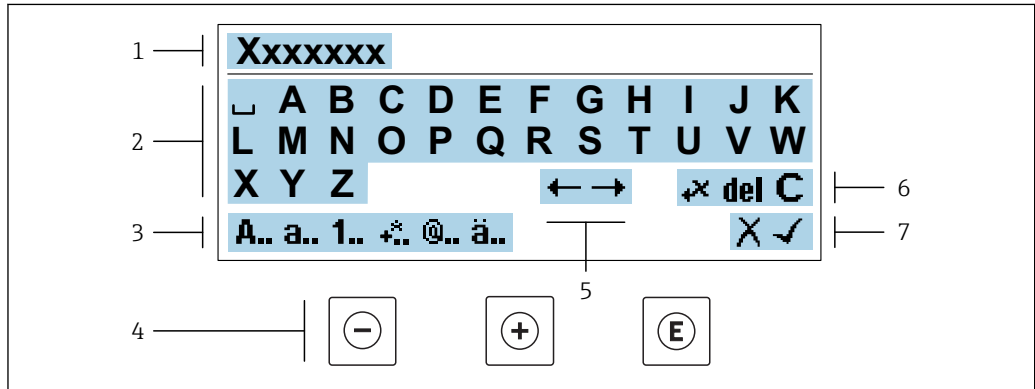

A0034114

20 For entering text in parameters (e.g. tag name)

- 1 Entry display area
- 2 Current input screen
- 3 Change input screen
- 4 Operating elements
- 5 Move entry position
- 6 Delete entry
- 7 Reject or confirm entry

*Using the operating elements in the editing view*





Operating key(s)	Meaning
	<b>Minus key</b> Move the entry position to the left.
	<b>Plus key</b> Move the entry position to the right.
	<b>Enter key</b> <ul style="list-style-type: none"> <li>▪ Press the key briefly: confirm your selection.</li> <li>▪ Press the key for 2 s: confirm the entry.</li> </ul>
	<b>Escape key combination (press keys simultaneously)</b> Close the editing view without accepting the changes.

*Input screens*



Symbol	Meaning
<b>A..</b>	Upper case
<b>a..</b>	Lower case
<b>1..</b>	Numbers
<b>+*</b>	Punctuation marks and special characters: = + - * / <sup>2</sup> <sup>3</sup> ¼ ½ ¾ ( ) [ ] < > { }
<b>@..</b>	Punctuation marks and special characters: ' " ^ . , ; : ? ! % μ ° € \$ £ ¥ \$ @ # / \   ~ & _
<b>ä..</b>	Umlauts and accents





Controlling data entries

Symbol	Meaning
	Move entry position
	Reject entry
	Confirm entry
	Delete character immediately to the left of the entry position
<b>del</b>	Delete character immediately to the right of the entry position
<b>C</b>	Clear all the characters entered

8.3.4 Operating elements

Operating key(s)	Meaning
	<p><b>Minus key</b></p> <p><i>In a menu, submenu</i> Moves the selection bar upwards in a picklist.</p> <p><i>With a Wizard</i> Confirms the parameter value and goes to the previous parameter.</p> <p><i>With a text and numeric editor</i> Move the entry position to the left.</p>
	<p><b>Plus key</b></p> <p><i>In a menu, submenu</i> Moves the selection bar downwards in a picklist.</p> <p><i>With a Wizard</i> Confirms the parameter value and goes to the next parameter.</p> <p><i>With a text and numeric editor</i> Move the entry position to the right.</p>
	<p><b>Enter key</b></p> <p><i>For operational display</i> Pressing the key briefly opens the operating menu.</p> <p><i>In a menu, submenu</i></p> <ul style="list-style-type: none"> <li>▪ Pressing the key briefly:             <ul style="list-style-type: none"> <li>▪ Opens the selected menu, submenu or parameter.</li> <li>▪ Starts the wizard.</li> <li>▪ If help text is open, closes the help text of the parameter.</li> </ul> </li> <li>▪ Pressing the key for 2 s for parameter: If present, opens the help text for the function of the parameter.</li> </ul> <p><i>With a Wizard</i> Opens the editing view of the parameter.</p> <p><i>With a text and numeric editor</i></p> <ul style="list-style-type: none"> <li>▪ Press the key briefly: confirm your selection.</li> <li>▪ Press the key for 2 s: confirm the entry.</li> </ul>

Operating key(s)	Meaning
	<p><b>Escape key combination (press keys simultaneously)</b></p> <p><i>In a menu, submenu</i></p> <ul style="list-style-type: none"> <li>▪ Pressing the key briefly:                     <ul style="list-style-type: none"> <li>▪ Exits the current menu level and takes you to the next higher level.</li> <li>▪ If help text is open, closes the help text of the parameter.</li> </ul> </li> <li>▪ Pressing the key for 2 s returns you to the operational display ("home position").</li> </ul> <p><i>With a Wizard</i> Exits the wizard and takes you to the next higher level.</p> <p><i>With a text and numeric editor</i> Close the editing view without accepting the changes.</p>
	<p><b>Minus/Enter key combination (press the keys simultaneously)</b></p> <ul style="list-style-type: none"> <li>▪ If the keypad lock is active: Press the key for 3 s: deactivate the keypad lock.</li> <li>▪ If the keypad lock is not active: Press the key for 3 s: the context menu opens along with the option for activating the keypad lock.</li> </ul>



### 8.3.5 Opening the context menu

Using the context menu, the user can call up the following menus quickly and directly from the operational display:

- Setup
- Data backup
- Simulation



#### Calling up and closing the context menu

The user is in the operational display.

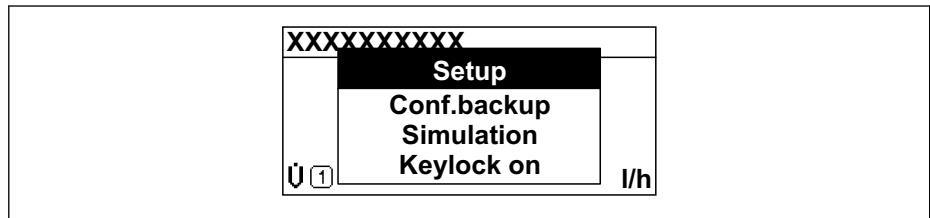

1. Press the  and  keys for longer than 3 seconds.
  - ↳ The context menu opens.



A0034608-EN

2. Press  +  simultaneously.
  - ↳ The context menu is closed and the operational display appears.

#### Calling up the menu via the context menu

1. Open the context menu.
2. Press  to navigate to the desired menu.
3. Press  to confirm the selection.
  - ↳ The selected menu opens.

### 8.3.6 Navigating and selecting from list

Different operating elements are used to navigate through the operating menu. The navigation path is displayed on the left in the header. Icons are displayed in front of the individual menus. These icons are also shown in the header during navigation.

**i** For an explanation of the navigation view with symbols and operating elements → 53

**Example: Setting the number of displayed measured values to "2 values"**

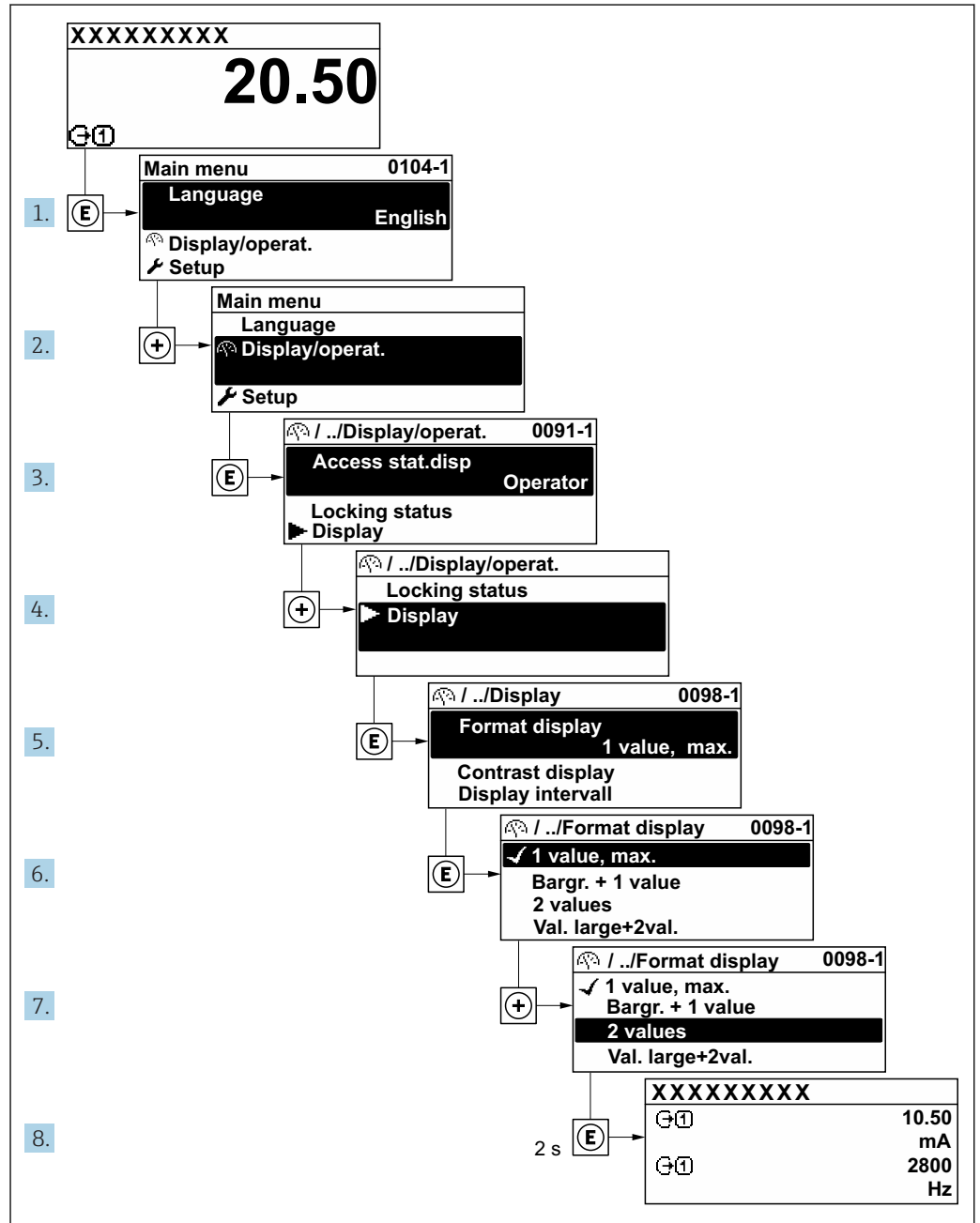

A0029562-EN

### 8.3.7 Calling the parameter directly

A parameter number is assigned to every parameter to be able to access a parameter directly via the onsite display. Entering this access code in the **Direct access** parameter calls up the desired parameter directly.

#### Navigation path

Expert → Direct access

The direct access code consists of a 5-digit number (at maximum) and the channel number, which identifies the channel of a process variable: e.g. 00914-2. In the navigation view, this appears on the right-hand side in the header of the selected parameter.

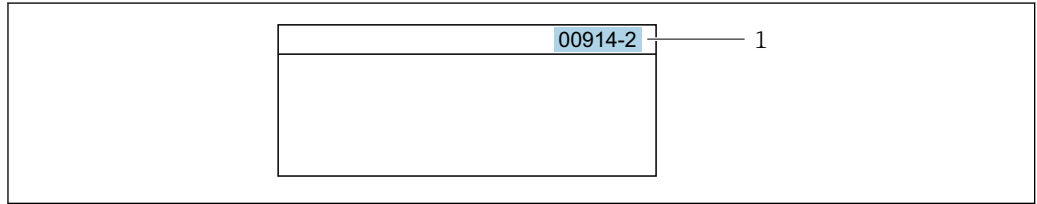

A0029414

1 Direct access code

Note the following when entering the direct access code:

- The leading zeros in the direct access code do not have to be entered.  
Example: Enter "914" instead of "00914"
- If no channel number is entered, channel 1 is accessed automatically.  
Example: Enter 00914 → **Assign process variable** parameter
- If a different channel is accessed: Enter the direct access code with the corresponding channel number.  
Example: Enter 00914-2 → **Assign process variable** parameter



For the direct access codes of the individual parameters, see the "Description of Device Parameters" document for the device

### 8.3.8 Calling up help text

Help text is available for some parameters and can be called up from the navigation view. The help text provides a brief explanation of the parameter function and thereby supports swift and safe commissioning.

#### Calling up and closing the help text

The user is in the navigation view and the selection bar is on a parameter.

1. Press for 2 s.
  - ↳ The help text for the selected parameter opens.

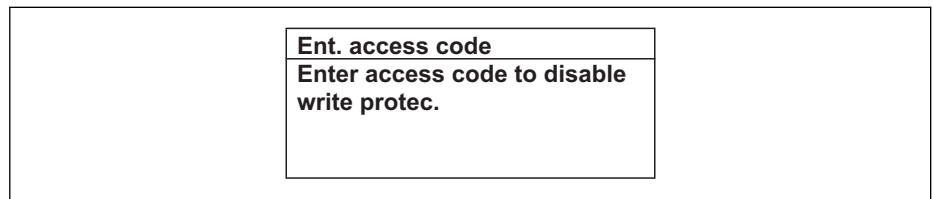

A0014002-EN

21 Example: Help text for parameter "Enter access code"

2. Press + simultaneously.
  - ↳ The help text is closed.

### 8.3.9 Changing the parameters



Parameters can be changed via the numeric editor or text editor.

- Numeric editor: Change values in a parameter, e.g. specifications for limit values.
- Text editor: Enter text in a parameter, e.g. tag name.

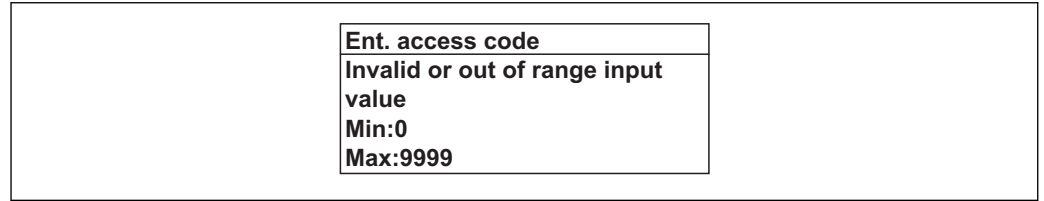
A message is displayed if the value entered is outside the permitted value range.



A0014049-EN

 For a description of the editing view - consisting of the text editor and numeric editor - with symbols →  55, for a description of the operating elements →  57

### 8.3.10 User roles and related access authorization

The two user roles "Operator" and "Maintenance" have different write access to the parameters if the customer defines a user-specific access code. This protects the device configuration via the local display from unauthorized access →  136.

#### Defining access authorization for user roles

An access code is not yet defined when the device is delivered from the factory. Access authorization (read and write access) to the device is not restricted and corresponds to the "Maintenance" user role.

- ▶ Define the access code.
  - ↳ The "Operator" user role is redefined in addition to the "Maintenance" user role. Access authorization differs for the two user roles.

#### Access authorization to parameters: "Maintenance" user role

Access code status	Read access	Write access
An access code has not yet been defined (factory setting).	✓	✓
After an access code has been defined.	✓	✓ <sup>1)</sup>

1) The user only has write access after entering the access code.



#### Access authorization to parameters: "Operator" user role

Access code status	Read access	Write access
After an access code has been defined.	✓	-- <sup>1)</sup>



1) Despite the defined access code, certain parameters can always be modified and thus are excepted from the write protection, as they do not affect the measurement. Refer to the "Write protection via access code" section

 The user role with which the user is currently logged on is indicated by the **Access status** parameter. Navigation path: Operation → Access status

### 8.3.11 Disabling write protection via access code

If the -symbol appears on the local display in front of a parameter, the parameter is write-protected by a user-specific access code and its value cannot be changed at the moment using local operation →  136.

Parameter write protection via local operation can be disabled by entering the user-specific access code in the **Enter access code** parameter (→  117) via the respective access option.

1. After you press , the input prompt for the access code appears.
2. Enter the access code.
  - ↳ The -symbol in front of the parameters disappears; all previously write-protected parameters are now re-enabled.

### 8.3.12 Enabling and disabling the keypad lock



The keypad lock makes it possible to block access to the entire operating menu via local operation. As a result, it is no longer possible to navigate through the operating menu or change the values of individual parameters. Users can only read the measured values on the operational display.

The keypad lock is switched on and off via the context menu.

#### Switching on the keypad lock



-  The keypad lock is switched on automatically:
  - If the device has not been operated via the display for > 1 minute.
  - Each time the device is restarted.

#### To activate the keylock manually:

1. The device is in the measured value display.  
Press the  and  keys for 3 seconds.  
↳ A context menu appears.
2. In the context menu select the **Keylock on** option.  
↳ The keypad lock is switched on.

-  If the user attempts to access the operating menu while the keypad lock is active, the **Keylock on** message appears.

#### Switching off the keypad lock

- ▶ The keypad lock is switched on.  
Press the  and  keys for 3 seconds.  
↳ The keypad lock is switched off.



## 8.4 Access to the operating menu via the Web browser

### 8.4.1 Function range

Thanks to the integrated Web server, the device can be operated and configured via a Web browser and via a service interface (CDI-RJ45) or via a WLAN interface. The structure of the operating menu is the same as for the local display. In addition to the measured values, status information on the device is also displayed and allows the user to monitor the status

of the device. Furthermore the device data can be managed and the network parameters can be configured.

A device that has a WLAN interface (can be ordered as an option) is required for the WLAN connection: order code for "Display; operation", option G "4-line, illuminated; touch control + WLAN". The device acts as an Access Point and enables communication by computer or a mobile handheld terminal.

 For additional information on the Web server, refer to the Special Documentation for the device →  221

### 8.4.2 Prerequisites

#### Computer hardware



Hardware	Interface	
	CDI-RJ45	WLAN
Interface	The computer must have an RJ45 interface.	The operating unit must have a WLAN interface.
Connection	Standard Ethernet cable with RJ45 connector.	Connection via Wireless LAN.
Screen	Recommended size: ≥12" (depends on the screen resolution)	

#### Computer software

Software	Interface	
	CDI-RJ45	WLAN
Recommended operating systems	<ul style="list-style-type: none"> <li>▪ Microsoft Windows 7 or higher.</li> <li>▪ Mobile operating systems:                             <ul style="list-style-type: none"> <li>▪ iOS</li> <li>▪ Android</li> </ul> </li> </ul>  Microsoft Windows XP is supported.	
Web browsers supported	<ul style="list-style-type: none"> <li>▪ Microsoft Internet Explorer 8 or higher</li> <li>▪ Microsoft Edge</li> <li>▪ Mozilla Firefox</li> <li>▪ Google Chrome</li> <li>▪ Safari</li> </ul>	



#### Computer settings

Settings	Interface	
	CDI-RJ45	WLAN
User rights	Appropriate user rights (e.g. administrator rights) for TCP/IP and proxy server settings are necessary (for adjusting the IP address, subnet mask etc.).	
Proxy server settings of the Web browser	The Web browser setting <i>Use a Proxy Server for Your LAN</i> must be <b>deselected</b> .	



Settings	Interface	
	CDI-RJ45	WLAN
JavaScript	JavaScript must be enabled.  If JavaScript cannot be enabled: enter <code>http://192.168.1.212/basic.html</code> in the address line of the Web browser. A fully functional but simplified version of the operating menu structure starts in the Web browser.   When installing a new firmware version: To enable correct data display, clear the temporary memory (cache) of the Web browser under <b>Internet options</b> .	
Network connections	Only the active network connections to the measuring device should be used. Switch off all other network connections such as WLAN.	
	Switch off all other network connections such as WLAN.	Switch off all other network connections.

 In the event of connection problems: →  154

*Measuring device: Via CDI-RJ45 service interface*

Device	CDI-RJ45 service interface
Measuring device	The measuring device has an RJ45 interface.
Web server	Web server must be enabled; factory setting: ON  For information on enabling the Web server →  68

*Measuring device: via WLAN interface*

Device	WLAN interface
Measuring device	The measuring device has a WLAN antenna: <ul style="list-style-type: none"> <li>▪ Transmitter with integrated WLAN antenna</li> <li>▪ Transmitter with external WLAN antenna</li> </ul>
Web server	Web server and WLAN must be enabled; factory setting: ON  For information on enabling the Web server →  68

### 8.4.3 Establishing a connection

#### Via service interface (CDI-RJ45)

*Preparing the measuring device*

1. Depending on the housing version:  
 Release the securing clamp or securing screw of the housing cover.
2. Depending on the housing version:  
 Unscrew or open the housing cover.
3. The location of the connection socket depends on the measuring device and the communication protocol:  
 Connect the computer to the RJ45 connector via the standard Ethernet connecting cable .



*Configuring the Internet protocol of the computer*

The following information refers to the default Ethernet settings of the device.

IP address of the device: 192.168.1.212 (factory setting)

1. Switch on the measuring device.
2. Connect to the computer using a cable →  70.
3. If a 2nd network card is not used, close all the applications on the notebook.
  - ↳ Applications requiring Internet or a network, such as e-mail, SAP applications, Internet or Windows Explorer.
4. Close any open Internet browsers.
5. Configure the properties of the Internet protocol (TCP/IP) as defined in the table:

<b>IP address</b>	192.168.1.XXX; for XXX all numerical sequences except: 0, 212 and 255 → e.g. 192.168.1.213
<b>Subnet mask</b>	255.255.255.0
<b>Default gateway</b>	192.168.1.212 or leave cells empty

**Via WLAN interface***Configuring the Internet protocol of the mobile terminal***NOTICE**

**If the WLAN connection is lost during the configuration, settings made may be lost.**

- ▶ Make sure that the WLAN connection is not disconnected while configuring the device.

**NOTICE**

**In principle, avoid simultaneous access to the measuring device via the service interface (CDI-RJ45) and the WLAN interface from the same mobile terminal. This could cause a network conflict.**

- ▶ Only activate one service interface (CDI-RJ45 service interface or WLAN interface).
- ▶ If simultaneous communication is necessary: configure different IP address ranges, e.g. 192.168.0.1 (WLAN interface) and 192.168.1.212 (CDI-RJ45 service interface).



*Preparing the mobile terminal*

- ▶ Enable WLAN reception on the mobile terminal.

*Establishing a connection from the mobile terminal to the measuring device*

1. In the WLAN settings of the mobile terminal:  
Select the measuring device using the SSID (e.g. EH\_Promass\_300\_A802000).
2. If necessary, select the WPA2 encryption method.

3. Enter the password: serial number of the measuring device ex-works (e.g. L100A802000).
  - ↳ LED on display module flashes: it is now possible to operate the measuring device with the Web browser, FieldCare or DeviceCare.

-  The serial number can be found on the nameplate.
-  To ensure the safe and swift assignment of the WLAN network to the measuring point, it is advisable to change the SSID name. It should be possible to clearly assign the new SSID name to the measuring point (e.g. tag name) because it is displayed as the WLAN network.

*Disconnecting*

- ▶ After configuring the device:  
Terminate the WLAN connection between the operating unit and measuring device.

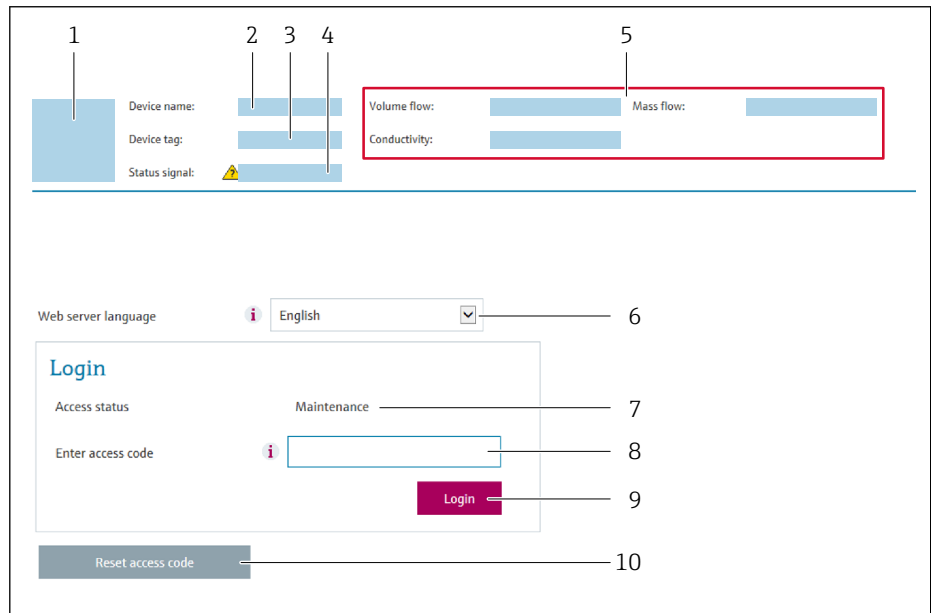

**Starting the Web browser**

1. Start the Web browser on the computer.
2. Enter the IP address of the Web server in the address line of the Web browser: 192.168.1.212
  - ↳ The login page appears.



A0029417

- 1 Picture of device
- 2 Device name
- 3 Device tag
- 4 Status signal
- 5 Current measured values
- 6 Operating language
- 7 User role
- 8 Access code
- 9 Login
- 10 Reset access code (→  132)

-  If a login page does not appear, or if the page is incomplete →  154

### 8.4.4 Logging on

1. Select the preferred operating language for the Web browser.
2. Enter the user-specific access code.
3. Press **OK** to confirm your entry.

<b>Access code</b>	0000 (factory setting); can be changed by customer
--------------------	--

**i** If no action is performed for 10 minutes, the Web browser automatically returns to the login page.

### 8.4.5 User interface

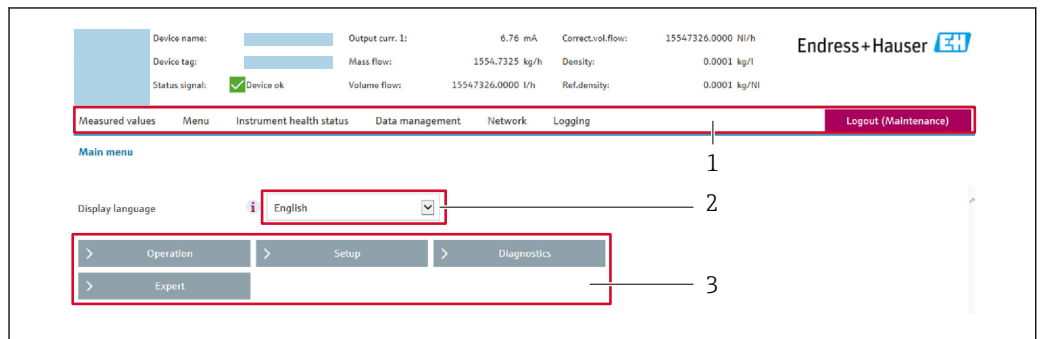

- 1 *Function row*
- 2 *Local display language*
- 3 *Navigation area*

#### Header

The following information appears in the header:

- Device name
- Device tag
- Device status with status signal → 160
- Current measured values

#### Function row

Functions	Meaning
Measured values	Displays the measured values of the measuring device
Menu	<ul style="list-style-type: none"> <li>■ Access to the operating menu from the measuring device</li> <li>■ The structure of the operating menu is the same as for the local display</li> </ul> <p><b>i</b> For detailed information on the structure of the operating menu, see the Operating Instructions for the measuring device</p>
Device status	Displays the diagnostic messages currently pending, listed in order of priority

Functions	Meaning
Data management	Data exchange between PC and measuring device: <ul style="list-style-type: none"> <li>▪ Device configuration:                             <ul style="list-style-type: none"> <li>▪ Load settings from the device (XML format, save configuration)</li> <li>▪ Save settings to the device (XML format, restore configuration)</li> </ul> </li> <li>▪ Logbook - Export Event logbook (.csv file)</li> <li>▪ Documents - Export documents:                             <ul style="list-style-type: none"> <li>▪ Export backup data record (.csv file, create documentation of the measuring point configuration)</li> <li>▪ Verification report (PDF file, only available with the "Heartbeat Verification" application package)</li> </ul> </li> <li>▪ Firmware update - Flashing a firmware version</li> </ul>
Network configuration	Configuration and checking of all the parameters required for establishing the connection to the measuring device: <ul style="list-style-type: none"> <li>▪ Network settings (e.g. IP address, MAC address)</li> <li>▪ Device information (e.g. serial number, firmware version)</li> </ul>
Logout	End the operation and call up the login page

**Navigation area**

If a function is selected in the function bar, the submenus of the function open in the navigation area. The user can now navigate through the menu structure.

**Working area**

Depending on the selected function and the related submenus, various actions can be performed in this area:

- Configuring parameters
- Reading measured values
- Calling up help text
- Starting an upload/download

**8.4.6 Disabling the Web server**

The Web server of the measuring device can be switched on and off as required using the **Web server functionality** parameter.

**Navigation**

"Expert" menu → Communication → Web server

**Parameter overview with brief description**

Parameter	Description	Selection	Factory setting
Web server functionality	Switch the Web server on and off.	<ul style="list-style-type: none"> <li>▪ Off</li> <li>▪ HTML Off</li> <li>▪ On</li> </ul>	On

### Function scope of the "Web server functionality" parameter

Option	Description
Off	<ul style="list-style-type: none"> <li>▪ The web server is completely disabled.</li> <li>▪ Port 80 is locked.</li> </ul>
On	<ul style="list-style-type: none"> <li>▪ The complete functionality of the web server is available.</li> <li>▪ JavaScript is used.</li> <li>▪ The password is transferred in an encrypted state.</li> <li>▪ Any change to the password is also transferred in an encrypted state.</li> </ul>

#### Enabling the Web server

If the Web server is disabled it can only be re-enabled with the **Web server functionality** parameter via the following operating options:

- Via local display
- Via Bedientool "FieldCare"
- Via "DeviceCare" operating tool

#### 8.4.7 Logging out

 Before logging out, perform a data backup via the **Data management** function (upload configuration from device) if necessary.

1. Select the **Logout** entry in the function row.  
↳ The home page with the Login box appears.
2. Close the Web browser.
3. If no longer needed:  
Reset modified properties of the Internet protocol (TCP/IP) →  65.

### 8.5 Access to the operating menu via the operating tool

The structure of the operating menu in the operating tools is the same as for operation via the local display.

#### 8.5.1 Connecting the operating tool

##### Via Modbus RS485 protocol

This communication interface is available in device versions with a Modbus-RS485 output.

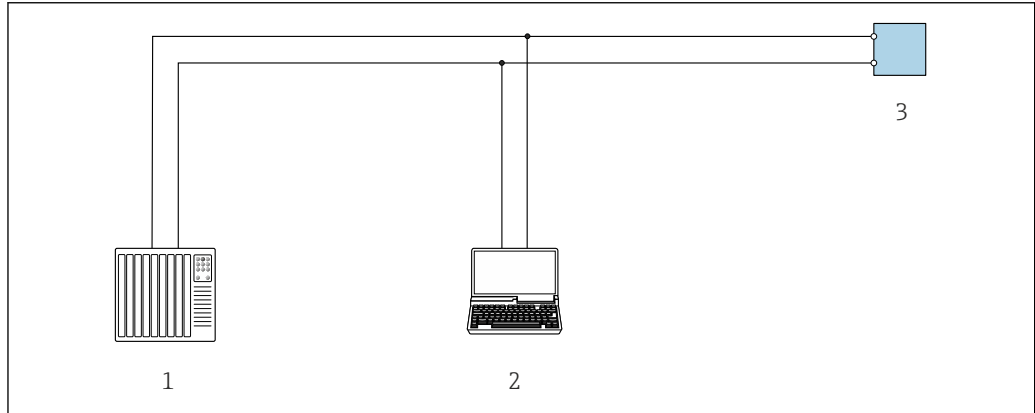

A0029437

22 Options for remote operation via Modbus-RS485 protocol (active)

- 1 Control system (e.g. PLC)
- 2 Computer with Web browser (e.g. Internet Explorer) for accessing the integrated device Web server or with operating tool (e.g. FieldCare, DeviceCare) with COM DTM "CDI Communication TCP/IP" or Modbus DTM
- 3 Transmitter

### Service interface

Via service interface (CDI-RJ45)

A point-to-point connection can be established to configure the device onsite. With the housing open, the connection is established directly via the service interface (CDI-RJ45) of the device.

**i** An adapter for RJ45 and the M12 connector is optionally available:  
Order code for "Accessories", option **NB**: "Adapter RJ45 M12 (service interface)"

The adapter connects the service interface (CDI-RJ45) to an M12 connector mounted in the cable entry. Therefore the connection to the service interface can be established via an M12 connector without opening the device.

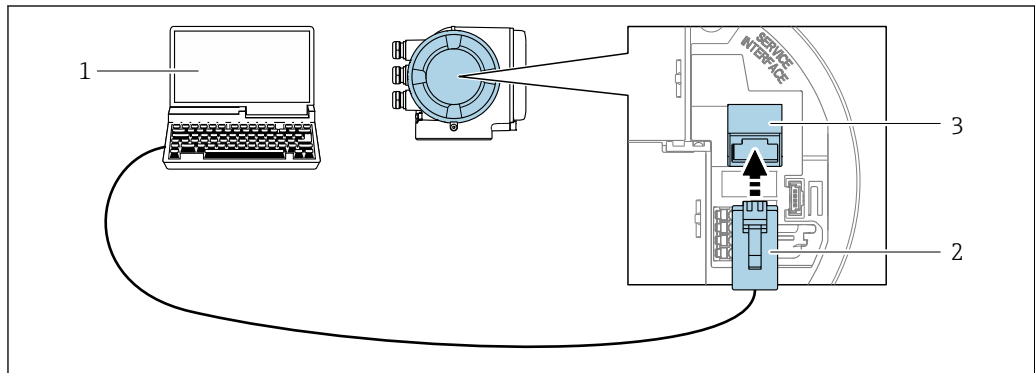

A0027563

23 Connection via service interface (CDI-RJ45)

- 1 Computer with Web browser (e.g. Microsoft Internet Explorer, Microsoft Edge) for accessing the integrated device Web server or with "FieldCare", "DeviceCare" operating tool with COM DTM "CDI Communication TCP/IP" or Modbus DTM
- 2 Standard Ethernet connecting cable with RJ45 connector
- 3 Service interface (CDI-RJ45) of the measuring device with access to the integrated Web server

Via WLAN interface

The optional WLAN interface is available on the following device version:  
 Order code for "Display; operation", option G "4-line, illuminated; touch control + WLAN"

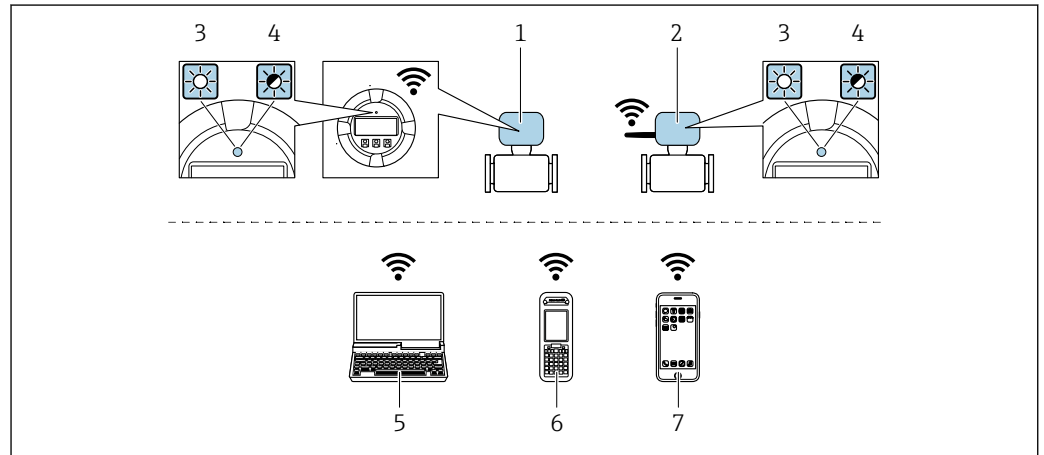

- 1 Transmitter with integrated WLAN antenna
- 2 Transmitter with external WLAN antenna
- 3 LED lit constantly: WLAN reception is enabled on measuring device
- 4 LED flashing: WLAN connection established between operating unit and measuring device
- 5 Computer with WLAN interface and Web browser (e.g. Microsoft Internet Explorer, Microsoft Edge) for accessing the integrated device Web server or with operating tool (e.g. FieldCare, DeviceCare)
- 6 Mobile handheld terminal with WLAN interface and Web browser (e.g. Microsoft Internet Explorer, Microsoft Edge) for accessing the integrated device Web server or operating tool (e.g. FieldCare, DeviceCare)
- 7 Smart phone or tablet (e.g. Field Xpert SMT70)

Function	WLAN: IEEE 802.11 b/g (2.4 GHz)
Encryption	WPA2-PSK AES-128 (in accordance with IEEE 802.11i)
Configurable WLAN channels	1 to 11
Degree of protection	IP67
Available antennas	<ul style="list-style-type: none"> <li>▪ Internal antenna</li> <li>▪ External antenna (optional)</li> </ul> In the event of poor transmission/reception conditions at the place of installation.  Only one antenna active in each case!
Range	<ul style="list-style-type: none"> <li>▪ Internal antenna: typically 10 m (32 ft)</li> <li>▪ External antenna: typically 50 m (164 ft)</li> </ul>
Materials (external antenna)	<ul style="list-style-type: none"> <li>▪ Antenna: ASA plastic (acrylic ester-styrene-acrylonitrile) and nickel-plated brass</li> <li>▪ Adapter: Stainless steel and nickel-plated brass</li> <li>▪ Cable: Polyethylene</li> <li>▪ Connector: Nickel-plated brass</li> <li>▪ Angle bracket: Stainless steel</li> </ul>

Configuring the Internet protocol of the mobile terminal

**NOTICE**

**If the WLAN connection is lost during the configuration, settings made may be lost.**

- ▶ Make sure that the WLAN connection is not disconnected while configuring the device.

**NOTICE**

**In principle, avoid simultaneous access to the measuring device via the service interface (CDI-RJ45) and the WLAN interface from the same mobile terminal. This could cause a network conflict.**

- ▶ Only activate one service interface (CDI-RJ45 service interface or WLAN interface).
- ▶ If simultaneous communication is necessary: configure different IP address ranges, e.g. 192.168.0.1 (WLAN interface) and 192.168.1.212 (CDI-RJ45 service interface).

*Preparing the mobile terminal*

- ▶ Enable WLAN reception on the mobile terminal.

*Establishing a connection from the mobile terminal to the measuring device*

1. In the WLAN settings of the mobile terminal:  
Select the measuring device using the SSID (e.g. EH\_Promass\_300\_A802000).
2. If necessary, select the WPA2 encryption method.
3. Enter the password: serial number of the measuring device ex-works (e.g. L100A802000).
  - ↳ LED on display module flashes: it is now possible to operate the measuring device with the Web browser, FieldCare or DeviceCare.



The serial number can be found on the nameplate.



To ensure the safe and swift assignment of the WLAN network to the measuring point, it is advisable to change the SSID name. It should be possible to clearly assign the new SSID name to the measuring point (e.g. tag name) because it is displayed as the WLAN network.

*Disconnecting*

- ▶ After configuring the device:  
Terminate the WLAN connection between the operating unit and measuring device.

## 8.5.2 FieldCare

### Function scope

FDT-based plant asset management tool from Endress+Hauser. It can configure all smart field devices in a system and helps you manage them. By using the status information, it is also a simple but effective way of checking their status and condition.

Access is via:

- CDI-RJ45 service interface → 70
- WLAN interface → 71

Typical functions:

- Configuring parameters of transmitters
- Loading and saving device data (upload/download)
- Documentation of the measuring point
- Visualization of the measured value memory (line recorder) and event logbook



For additional information about FieldCare, see Operating Instructions BA00027S and BA00059S



### Source for device description files

See information → 75

### Establishing a connection

For additional information, see Operating Instructions BA00027S and BA00059S

### User interface

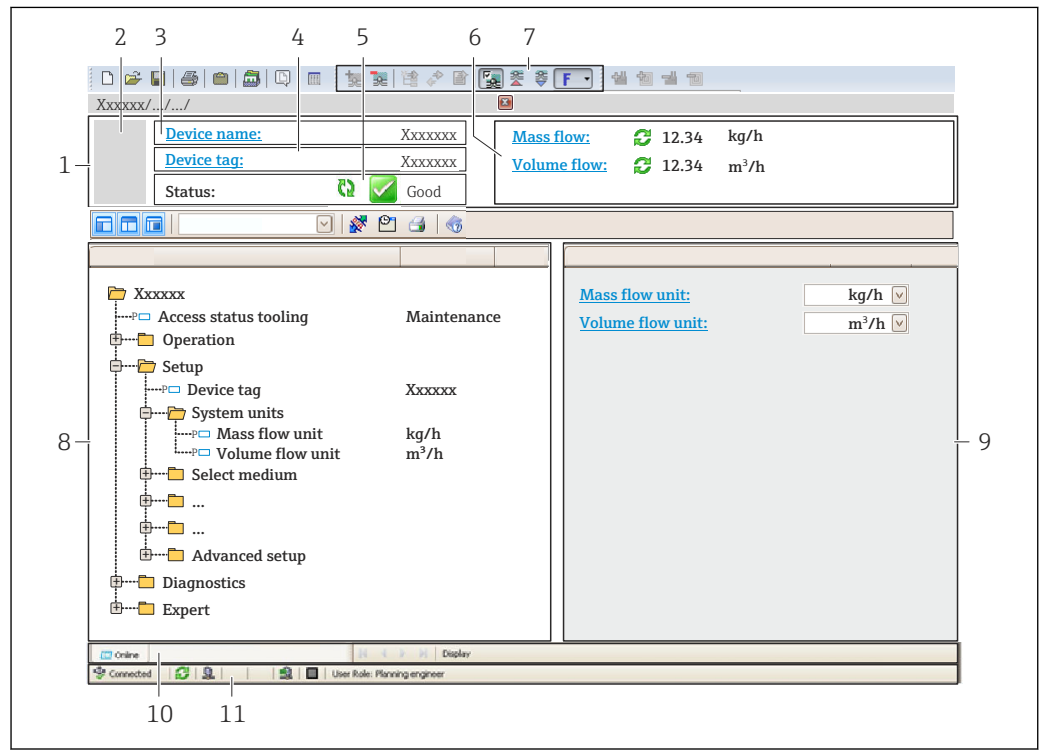

- 1 Header
- 2 Picture of device
- 3 Device name
- 4 Device tag
- 5 Status area with status signal → 160
- 6 Display area for current measured values
- 7 Edit toolbar with additional functions such as save/restore, event list and create documentation
- 8 Navigation area with operating menu structure
- 9 Working area
- 10 Range of action
- 11 Status area

## 8.5.3 DeviceCare

### Function scope

Tool to connect and configure Endress+Hauser field devices.

The fastest way to configure Endress+Hauser field devices is with the dedicated "DeviceCare" tool. Together with the device type managers (DTMs) it presents a convenient, comprehensive solution.



For details, see Innovation Brochure IN01047S

### **Source for device description files**



See information →  75

## 9 System integration

### 9.1 Overview of device description files

#### 9.1.1 Current version data for the device

Firmware version	01.05.zz	<ul style="list-style-type: none"> <li>▪ On the title page of the Operating Instructions</li> <li>▪ On the transmitter nameplate</li> <li>▪ Firmware version Diagnostics → Device information → Firmware version</li> </ul>
Release date of firmware version	08.2019	---

 For an overview of the different firmware versions for the device →  175

#### 9.1.2 Operating tools

The suitable device description file for the individual operating tools is listed in the table below, along with information on where the file can be acquired.

Operating tool via service interface (CDI) or Modbus interface	Sources for obtaining device descriptions
FieldCare	<ul style="list-style-type: none"> <li>▪ <a href="http://www.endress.com">www.endress.com</a> → Download Area</li> <li>▪ CD-ROM (contact Endress+Hauser)</li> <li>▪ DVD (contact Endress+Hauser)</li> </ul>
DeviceCare	<ul style="list-style-type: none"> <li>▪ <a href="http://www.endress.com">www.endress.com</a> → Download Area</li> <li>▪ CD-ROM (contact Endress+Hauser)</li> <li>▪ DVD (contact Endress+Hauser)</li> </ul>

## 9.2 Compatibility with earlier model



If the device is replaced, the measuring device Promass 300 supports the compatibility of the Modbus registers for the process variables and the diagnostic information with the previous model Promass 83. It is not necessary to change the engineering parameters in the automation system.

*Compatible Modbus registers: process variables*

Process variable	Compatible Modbus registers
Mass flow	2007
Volume flow	2009
Corrected volume flow	2011
Density	2013
Reference density	2015
Temperature	2017
Totalizer 1	2610
Totalizer 2	2810
Totalizer 3	3010

*Compatible Modbus registers: diagnostic information*



Diagnostic information	Compatible Modbus registers
Diagnostic code (data type: String), e.g. F270	6821
Diagnostic number (data type: Integer), e.g. 270	6859



 The Modbus registers are compatible but the diagnostic numbers are not. Overview of the new diagnostic numbers →  163.

## 9.3 Modbus RS485 information

### 9.3.1 Function codes



Function codes are used to define which read or write action is carried out via the Modbus protocol. The measuring device supports the following function codes:

Code	Name	Description	Application
03	Read holding register	<p>Master reads one or more Modbus registers from the device. A maximum of 125 consecutive registers can be read with 1 telegram: 1 register = 2 bytes</p> <p> The measuring device does not make a distinction between function codes 03 and 04; these codes therefore yield the same result.</p>	<p>Read device parameters with read and write access</p> <p>Example: Read mass flow</p>
04	Read input register	<p>Master reads one or more Modbus registers from the device. A maximum of 125 consecutive registers can be read with 1 telegram: 1 register = 2 bytes</p> <p> The measuring device does not make a distinction between function codes 03 and 04; these codes therefore yield the same result.</p>	<p>Read device parameters with read access</p> <p>Example: Read totalizer value</p>
06	Write single registers	<p>Master writes a new value to <b>one</b> Modbus register of the measuring device.</p> <p> Use function code 16 to write multiple registers with just 1 telegram.</p>	<p>Write only 1 device parameter</p> <p>Example: reset totalizer</p>
08	Diagnostics	<p>Master checks the communication connection to the measuring device. The following "Diagnostics codes" are supported:</p> <ul style="list-style-type: none"> <li>▪ Sub-function 00 = Return query data (loopback test)</li> <li>▪ Sub-function 02 = Return diagnostics register</li> </ul>	

Code	Name	Description	Application
16	Write multiple registers	<p>Master writes a new value to multiple Modbus registers of the device. A maximum of 120 consecutive registers can be written with 1 telegram.</p> <p> If the required device parameters are not available as a group, yet must nevertheless be addressed with a single telegram, use Modbus data map →  79</p>	<p>Write multiple device parameters</p> <p>Example:</p> <ul style="list-style-type: none"> <li>▪ Mass flow unit</li> <li>▪ Mass unit</li> </ul>
23	Read/Write multiple registers	<p>Master reads and writes a maximum of 118 Modbus registers of the measuring device simultaneously with 1 telegram. Write access is executed <b>before</b> read access.</p>	<p>Write and read multiple device parameters</p> <p>Example:</p> <ul style="list-style-type: none"> <li>▪ Read mass flow</li> <li>▪ Reset totalizer</li> </ul>

 Broadcast messages are only allowed with function codes 06, 16 and 23.

### 9.3.2 Register information

 For an overview of device parameters with their respective Modbus register information, please refer to the "Modbus RS485 register information" section in the "Description of device parameters" documentation →  220.

### 9.3.3 Response time

Response time of the measuring device to the request telegram of the Modbus master: typically 3 to 5 ms

### 9.3.4 Data types

The measuring device supports the following data types:

<b>FLOAT</b> (floating point number IEEE 754) Data length = 4 bytes (2 registers)			
Byte 3	Byte 2	Byte 1	Byte 0
SEEEEEEE	EMMMMMMM	MMMMMMMM	MMMMMMMM
S = sign, E = exponent, M = mantissa			

<b>INTEGER</b> Data length = 2 bytes (1 register)	
Byte 1	Byte 0
Most significant byte (MSB)	Least significant byte (LSB)

<b>STRING</b>				
Data length = depends on the device parameter, e.g. presentation of a device parameter with a data length = 18 bytes (9 registers)				
Byte 17	Byte 16	...	Byte 1	Byte 0
Most significant byte (MSB)		...		Least significant byte (LSB)

### 9.3.5 Byte transmission sequence

Byte addressing, i.e. the transmission sequence of the bytes, is not specified in the Modbus specification. For this reason, it is important to coordinate or match the addressing method between the master and slave during commissioning. This can be configured in the measuring device using the **Byte order** parameter.

The bytes are transmitted depending on the selection in the **Byte order** parameter:

<b>FLOAT</b>				
	Sequence			
Options	1.	2.	3.	4.
1 - 0 - 3 - 2 *	Byte 1 (MMMMMMMM)	Byte 0 (MMMMMMMM)	Byte 3 (SEEEEEEE)	Byte 2 (EMMMMMMM)
0 - 1 - 2 - 3	Byte 0 (MMMMMMMM)	Byte 1 (MMMMMMMM)	Byte 2 (EMMMMMMM)	Byte 3 (SEEEEEEE)
2 - 3 - 0 - 1	Byte 2 (EMMMMMMM)	Byte 3 (SEEEEEEE)	Byte 0 (MMMMMMMM)	Byte 1 (MMMMMMMM)
3 - 2 - 1 - 0	Byte 3 (SEEEEEEE)	Byte 2 (EMMMMMMM)	Byte 1 (MMMMMMMM)	Byte 0 (MMMMMMMM)

\* = factory setting, S = sign, E = exponent, M = mantissa

<b>INTEGER</b>		
	Sequence	
Options	1.	2.
1 - 0 - 3 - 2 * 3 - 2 - 1 - 0	Byte 1 (MSB)	Byte 0 (LSB)
0 - 1 - 2 - 3 2 - 3 - 0 - 1	Byte 0 (LSB)	Byte 1 (MSB)

\* = factory setting, MSB = most significant byte, LSB = least significant byte

<b>STRING</b>					
Presentation taking the example of a device parameter with a data length of 18 bytes.					
	Sequence				
Options	1.	2.	...	17.	18.
1 - 0 - 3 - 2 * 3 - 2 - 1 - 0	Byte 17 (MSB)	Byte 16	...	Byte 1	Byte 0 (LSB)
0 - 1 - 2 - 3 2 - 3 - 0 - 1	Byte 16	Byte 17 (MSB)	...	Byte 0 (LSB)	Byte 1

\* = factory setting, MSB = most significant byte, LSB = least significant byte

### 9.3.6 Modbus data map

#### Function of the Modbus data map



The device offers a special memory area, the Modbus data map (for a maximum of 16 device parameters), to allow users to call up multiple device parameters via Modbus RS485 and not only individual device parameters or a group of consecutive device parameters.

Grouping of device parameters is flexible and the Modbus master can read or write to the entire data block simultaneously with a single request telegram.

#### Structure of the Modbus data map

The Modbus data map consists of two data sets:

- Scan list: Configuration area  
The device parameters to be grouped are defined in a list in that their Modbus RS485 register addresses are entered in the list.
- Data area  
The measuring device reads out the register addresses entered in the scan list cyclically and writes the associated device data (values) to the data area.

 For an overview of device parameters with their respective Modbus register information, please refer to the "Modbus RS485 register information" section in the "Description of device parameters" documentation →  220.

#### Scan list configuration

For configuration, the Modbus RS485 register addresses of the device parameters to be grouped must be entered in the scan list. Please note the following basic requirements of the scan list:

<b>Max. entries</b>	16 device parameters
<b>Supported device parameters</b>	Only parameters with the following characteristics are supported: <ul style="list-style-type: none"> <li>■ Access type: read or write access</li> <li>■ Data type: float or integer</li> </ul>

#### Configuring the scan list via FieldCare or DeviceCare

Carried out using the operating menu of the measuring device:  
Expert → Communication → Modbus data map → Scan list register 0 to 15

Scan list	
No.	Configuration register
0	Scan list register 0
...	...
15	Scan list register 15

*Configuring the scan list via Modbus RS485*

Carried out using register addresses 5001 - 5016

Scan list			
No.	Modbus RS485 register	Data type	Configuration register
0	5001	Integer	Scan list register 0
...	...	Integer	...
15	5016	Integer	Scan list register 15

**Reading out data via Modbus RS485**

The Modbus master accesses the data area of the Modbus data map to read out the current values of the device parameters defined in the scan list.

<b>Master access to data area</b>	Via register addresses 5051-5081
-----------------------------------	----------------------------------

Data area				
Device parameter value	Modbus RS485 register		Data type*	Access**
	Start register	End register (Float only)		
Value of scan list register 0	5051	5052	Integer/float	Read/write
Value of scan list register 1	5053	5054	Integer/float	Read/write
Value of scan list register ...	...	...	...	...
Value of scan list register 15	5081	5082	Integer/float	Read/write



\* Data type depends on the device parameters entered in the scan list.  
 \*\* Data access depends on the device parameters entered in the scan list. If the device parameter entered supports read and write access, the parameter can also be accessed via the data area.



## 10 Commissioning

### 10.1 Function check

Before commissioning the measuring device:

- ▶ Make sure that the post-installation and post-connection checks have been performed.
  - "Post-installation check" checklist →  32
  - "Post-connection check" checklist →  46

### 10.2 Setting the operating language

Factory setting: English or ordered local language

The operating language can be set in FieldCare or DeviceCare: Operation → Display language

### 10.3 Configuring the measuring device

- The **Setup** menu with its guided wizards contains all the parameters needed for standard operation.
- Navigation to the **Setup** menu

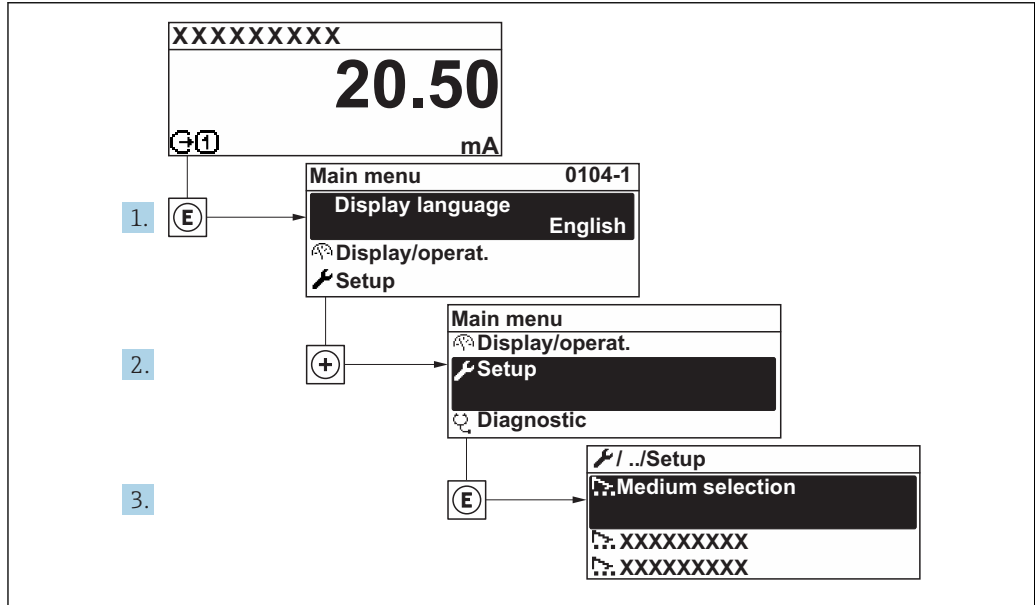

24 Taking the example of the local display

**i** The number of submenus and parameters can vary depending on the device version. Certain submenus and parameters in these submenus are not described in the Operation Instructions. Instead a description is provided in the Special Documentation for the device (→ "Supplementary documentation" section).

🔧 Setup	
Device tag	
▶ System units	→ 83
▶ Communication	→ 85
▶ Medium selection	→ 87
▶ I/O configuration	→ 89
▶ Current input 1 to n	→ 89
▶ Status input 1 to n	→ 91
▶ Current output 1 to n	→ 92
▶ Pulse/frequency/switch output 1 to n	→ 96
▶ Relay output 1 to n	→ 105

▶ Double pulse output	→ 108
▶ Display	→ 109
▶ Low flow cut off	→ 114
▶ Partially filled pipe detection	→ 115
▶ Advanced setup	→ 116

### 10.3.1 Defining the tag name

To enable fast identification of the measuring point within the system, you can enter a unique designation using the **Device tag** parameter and thus change the factory setting.

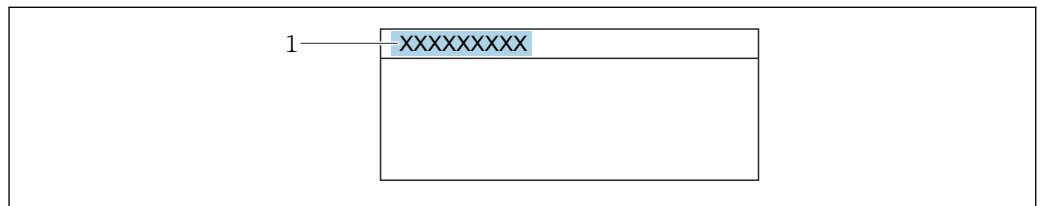

25 Header of the operational display with tag name

1 Tag name

**i** Enter the tag name in the "FieldCare" operating tool → 73

#### Navigation

"Setup" menu → Device tag

#### Parameter overview with brief description

Parameter	Description	User entry	Factory setting
Device tag	Enter the name for the measuring point.	Max. 32 characters, such as letters, numbers or special characters (e.g. @, %, /).	Promag

### 10.3.2 Setting the system units

In the **System units** submenu the units of all the measured values can be set.

**i** The number of submenus and parameters can vary depending on the device version. Certain submenus and parameters in these submenus are not described in the Operation Instructions. Instead a description is provided in the Special Documentation for the device (→ "Supplementary documentation" section).

**Navigation**

"Setup" menu → System units

► System units	
Mass flow unit	→ 84
Mass unit	→ 84
Volume flow unit	→ 84
Volume unit	→ 84
Corrected volume flow unit	→ 85
Corrected volume unit	→ 85
Density unit	→ 85
Reference density unit	→ 85
Temperature unit	→ 85
Pressure unit	→ 85

**Parameter overview with brief description**

Parameter	Description	Selection	Factory setting
Mass flow unit	Select mass flow unit. <i>Result</i> The selected unit applies for: <ul style="list-style-type: none"> <li>▪ Output</li> <li>▪ Low flow cut off</li> <li>▪ Simulation process variable</li> </ul>	Unit choose list	Country-specific: <ul style="list-style-type: none"> <li>▪ kg/h</li> <li>▪ lb/min</li> </ul>
Mass unit	Select mass unit.	Unit choose list	Country-specific: <ul style="list-style-type: none"> <li>▪ kg</li> <li>▪ lb</li> </ul>
Volume flow unit	Select volume flow unit. <i>Result</i> The selected unit applies for: <ul style="list-style-type: none"> <li>▪ Output</li> <li>▪ Low flow cut off</li> <li>▪ Simulation process variable</li> </ul>	Unit choose list	Country-specific: <ul style="list-style-type: none"> <li>▪ l/h</li> <li>▪ gal/min (us)</li> </ul>
Volume unit	Select volume unit.	Unit choose list	Country-specific: <ul style="list-style-type: none"> <li>▪ 1 (DN &gt; 150 (6"): m<sup>3</sup>)</li> <li>▪ gal (us)</li> </ul>

Parameter	Description	Selection	Factory setting
Corrected volume flow unit	Select corrected volume flow unit. <i>Result</i> The selected unit applies for: <b>Corrected volume flow</b> parameter (→ ⓘ 141)	Unit choose list	Country-specific: <ul style="list-style-type: none"> <li>▪ NI/h</li> <li>▪ Sft<sup>3</sup>/min</li> </ul>
Corrected volume unit	Select corrected volume unit.	Unit choose list	Country-specific: <ul style="list-style-type: none"> <li>▪ NI</li> <li>▪ Sft<sup>3</sup></li> </ul>
Density unit	Select density unit. <i>Result</i> The selected unit applies for: <ul style="list-style-type: none"> <li>▪ Output</li> <li>▪ Simulation process variable</li> <li>▪ Density adjustment (<b>Expert</b> menu)</li> </ul>	Unit choose list	Country-specific: <ul style="list-style-type: none"> <li>▪ kg/l</li> <li>▪ lb/ft<sup>3</sup></li> </ul>
Reference density unit	Select reference density unit.	Unit choose list	Country-dependent <ul style="list-style-type: none"> <li>▪ kg/NI</li> <li>▪ lb/Sft<sup>3</sup></li> </ul>
Temperature unit	Select temperature unit. <i>Result</i> The selected unit applies for: <ul style="list-style-type: none"> <li>▪ <b>Electronic temperature</b> parameter (6053)</li> <li>▪ <b>Maximum value</b> parameter (6051)</li> <li>▪ <b>Minimum value</b> parameter (6052)</li> <li>▪ <b>External temperature</b> parameter (6080)</li> <li>▪ <b>Maximum value</b> parameter (6108)</li> <li>▪ <b>Minimum value</b> parameter (6109)</li> <li>▪ <b>Carrier pipe temperature</b> parameter (6027)</li> <li>▪ <b>Maximum value</b> parameter (6029)</li> <li>▪ <b>Minimum value</b> parameter (6030)</li> <li>▪ <b>Reference temperature</b> parameter (1816)</li> <li>▪ <b>Temperature</b> parameter</li> </ul>	Unit choose list	Country-specific: <ul style="list-style-type: none"> <li>▪ °C</li> <li>▪ °F</li> </ul>
Pressure unit	Select process pressure unit. <i>Result</i> The unit is taken from: <ul style="list-style-type: none"> <li>▪ <b>Pressure value</b> parameter (→ ⓘ 88)</li> <li>▪ <b>External pressure</b> parameter (→ ⓘ 88)</li> <li>▪ Pressure value</li> </ul>	Unit choose list	Country-specific: <ul style="list-style-type: none"> <li>▪ bar a</li> <li>▪ psi a</li> </ul>

### 10.3.3 Configuring the communication interface

The **Communication** submenu guides you systematically through all the parameters that have to be configured for selecting and setting the communication interface.

**Navigation**

"Setup" menu → Communication

► Communication	
Bus address	→ 86
Baudrate	→ 86
Data transfer mode	→ 86
Parity	→ 86
Byte order	→ 86
Failure mode	→ 86

**Parameter overview with brief description**

Parameter	Description	User entry / Selection	Factory setting
Bus address	Enter device address.	1 to 247	247
Baudrate	Define data transfer speed.	<ul style="list-style-type: none"> <li>■ 1200 BAUD</li> <li>■ 2400 BAUD</li> <li>■ 4800 BAUD</li> <li>■ 9600 BAUD</li> <li>■ 19200 BAUD</li> <li>■ 38400 BAUD</li> <li>■ 57600 BAUD</li> <li>■ 115200 BAUD</li> </ul>	19200 BAUD
Data transfer mode	Select data transfer mode.	<ul style="list-style-type: none"> <li>■ ASCII</li> <li>■ RTU</li> </ul>	RTU
Parity	Select parity bits.	Picklist <b>ASCII</b> option: <ul style="list-style-type: none"> <li>■ 0 = <b>Even</b> option</li> <li>■ 1 = <b>Odd</b> option</li> </ul> Picklist <b>RTU</b> option: <ul style="list-style-type: none"> <li>■ 0 = <b>Even</b> option</li> <li>■ 1 = <b>Odd</b> option</li> <li>■ 2 = <b>None / 1 stop bit</b> option</li> <li>■ 3 = <b>None / 2 stop bits</b> option</li> </ul>	Even
Byte order	Select byte transmission sequence.	<ul style="list-style-type: none"> <li>■ 0-1-2-3</li> <li>■ 3-2-1-0</li> <li>■ 1-0-3-2</li> <li>■ 2-3-0-1</li> </ul>	1-0-3-2
Failure mode	Select measured value output behavior when a diagnostic message occurs via Modbus communication. NaN <sup>1)</sup>	<ul style="list-style-type: none"> <li>■ NaN value</li> <li>■ Last valid value</li> </ul>	NaN value

1) Not a Number

### 10.3.4 Selecting and setting the medium

The **Select medium** wizard submenu contains parameters that must be configured in order to select and set the medium.

#### Navigation

"Setup" menu → Select medium

► Medium selection	
Select medium	→ ⓘ 88
Select gas type	→ ⓘ 88
Reference sound velocity	→ ⓘ 88
Temperature coefficient sound velocity	→ ⓘ 88
Pressure compensation	→ ⓘ 88
Pressure value	→ ⓘ 88
External pressure	→ ⓘ 88

## Parameter overview with brief description

Parameter	Prerequisite	Description	Selection / User entry	Factory setting
Select medium	–	Select medium type.	<ul style="list-style-type: none"> <li>■ Liquid</li> <li>■ Gas</li> </ul>	Liquid
Select gas type	The <b>Gas</b> option is selected in the <b>Select medium</b> parameter.	Select measured gas type.	<ul style="list-style-type: none"> <li>■ Air</li> <li>■ Ammonia NH3</li> <li>■ Argon Ar</li> <li>■ Sulfur hexafluoride SF6</li> <li>■ Oxygen O2</li> <li>■ Ozone O3</li> <li>■ Nitrogen oxide NOx</li> <li>■ Nitrogen N2</li> <li>■ Nitrous oxide N2O</li> <li>■ Methane CH4</li> <li>■ Hydrogen H2</li> <li>■ Helium He</li> <li>■ Hydrogen chloride HCl</li> <li>■ Hydrogen sulfide H2S</li> <li>■ Ethylene C2H4</li> <li>■ Carbon dioxide CO2</li> <li>■ Carbon monoxide CO</li> <li>■ Chlorine Cl2</li> <li>■ Butane C4H10</li> <li>■ Propane C3H8</li> <li>■ Propylene C3H6</li> <li>■ Ethane C2H6</li> <li>■ Others</li> </ul>	Methane CH4
Reference sound velocity	In the <b>Select gas type</b> parameter, the <b>Others</b> option is selected.	Enter sound velocity of gas at 0 °C (32 °F).	1 to 99999.9999 m/s	415.0 m/s
Temperature coefficient sound velocity	The <b>Others</b> option is selected in the <b>Select gas type</b> parameter.	Enter temperature coefficient for the gas sound velocity.	Positive floating-point number	0 (m/s)/K
Pressure compensation	–	Select pressure compensation type.	<ul style="list-style-type: none"> <li>■ Off</li> <li>■ Fixed value</li> <li>■ External value</li> <li>■ Current input 1 *</li> <li>■ Current input 2 *</li> </ul>	Off
Pressure value	The <b>Fixed value</b> option or the <b>Current input 1...n</b> option is selected in the <b>Pressure compensation</b> parameter.	Enter process pressure to be used for pressure correction.	Positive floating-point number	1.01325 bar
External pressure	The <b>Fixed value</b> option or the <b>Current input 1...n</b> option is selected in the <b>Pressure compensation</b> parameter.	Shows the external process pressure value.	Positive floating-point number	1.01325 bar

\* Visibility depends on order options or device settings



### 10.3.5 Displaying the I/O configuration

The **I/O configuration** submenu guides the user systematically through all the parameters in which the configuration of the I/O modules is displayed.

#### Navigation

"Setup" menu → I/O configuration

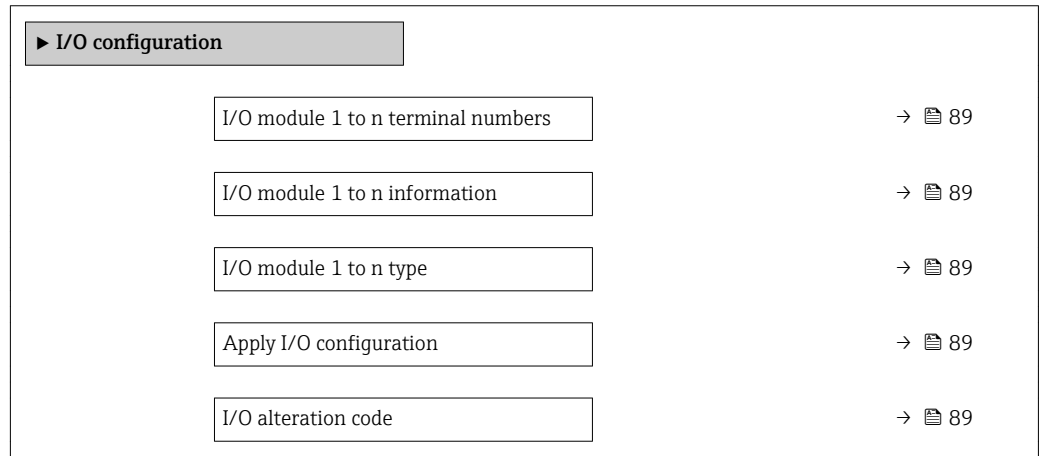

#### Parameter overview with brief description

Parameter	Description	User interface / Selection / User entry	Factory setting
I/O module 1 to n terminal numbers	Shows the terminal numbers used by the I/O module.	<ul style="list-style-type: none"> <li>▪ Not used</li> <li>▪ 26-27 (I/O 1)</li> <li>▪ 24-25 (I/O 2)</li> <li>▪ 22-23 (I/O 3)</li> </ul>	–
I/O module 1 to n information	Shows information of the plugged I/O module.	<ul style="list-style-type: none"> <li>▪ Not plugged</li> <li>▪ Invalid</li> <li>▪ Not configurable</li> <li>▪ Configurable</li> <li>▪ MODBUS</li> </ul>	–
I/O module 1 to n type	Shows the I/O module type.	<ul style="list-style-type: none"> <li>▪ Off</li> <li>▪ Current output *</li> <li>▪ Current input *</li> <li>▪ Status input *</li> <li>▪ Pulse/frequency/switch output *</li> <li>▪ Double pulse output *</li> <li>▪ Relay output *</li> </ul>	Off
Apply I/O configuration	Apply parameterization of the freely configurable I/O module.	<ul style="list-style-type: none"> <li>▪ No</li> <li>▪ Yes</li> </ul>	No
I/O alteration code	Enter the code in order to change the I/O configuration.	Positive integer	0

\* Visibility depends on order options or device settings

### 10.3.6 Configuring the current input

The **"Current input" wizard** guides the user systematically through all the parameters that have to be set for configuring the current input.

**Navigation**

"Setup" menu → Current input

► Current input 1 to n		
Terminal number		→ 90
Signal mode		→ 90
0/4 mA value		→ 90
20 mA value		→ 90
Current span		→ 90
Failure mode		→ 91
Failure value		→ 91

**Parameter overview with brief description**

Parameter	Prerequisite	Description	User interface / Selection / User entry	Factory setting
Terminal number	–	Shows the terminal numbers used by the current input module.	<ul style="list-style-type: none"> <li>▪ Not used</li> <li>▪ 24-25 (I/O 2)</li> <li>▪ 22-23 (I/O 3)</li> </ul>	–
Signal mode	The measuring device is <b>not</b> approved for use in the hazardous area with type of protection Ex-i.	Select the signal mode for the current input.	<ul style="list-style-type: none"> <li>▪ Passive</li> <li>▪ Active *</li> </ul>	Active
0/4 mA value	–	Enter 4 mA value.	Signed floating-point number	0
20 mA value	–	Enter 20 mA value.	Signed floating-point number	Depends on country and nominal diameter
Current span	–	Select current range for process value output and upper/lower level for alarm signal.	<ul style="list-style-type: none"> <li>▪ 4...20 mA (4...20.5 mA)</li> <li>▪ 4...20 mA NAMUR (3.8...20.5 mA)</li> <li>▪ 4...20 mA US (3.9...20.8 mA)</li> <li>▪ 0...20 mA (0...20.5 mA)</li> </ul>	Country-specific: <ul style="list-style-type: none"> <li>▪ 4...20 mA NAMUR (3.8...20.5 mA)</li> <li>▪ 4...20 mA US (3.9...20.8 mA)</li> </ul>

Parameter	Prerequisite	Description	User interface / Selection / User entry	Factory setting
Failure mode	-	Define input behavior in alarm condition.	<ul style="list-style-type: none"> <li>▪ Alarm</li> <li>▪ Last valid value</li> <li>▪ Defined value</li> </ul>	Alarm
Failure value	In the <b>Failure mode</b> parameter, the <b>Defined value</b> option is selected.	Enter value to be used by the device if input value from external device is missing.	Signed floating-point number	0

\* Visibility depends on order options or device settings

### 10.3.7 Configuring the status input

The **Status input** submenu guides the user systematically through all the parameters that have to be set for configuring the status input.

#### Navigation

"Setup" menu → Status input

▶ Status input 1 to n

Assign status input	→ ⓘ 91
Terminal number	→ ⓘ 91
Active level	→ ⓘ 92
Terminal number	→ ⓘ 91
Response time status input	→ ⓘ 92
Terminal number	→ ⓘ 91

#### Parameter overview with brief description

Parameter	Description	User interface / Selection / User entry	Factory setting
Terminal number	Shows the terminal numbers used by the status input module.	<ul style="list-style-type: none"> <li>▪ Not used</li> <li>▪ 24-25 (I/O 2)</li> <li>▪ 22-23 (I/O 3)</li> </ul>	-
Assign status input	Select function for the status input.	<ul style="list-style-type: none"> <li>▪ Off</li> <li>▪ Reset totalizer 1</li> <li>▪ Reset totalizer 2</li> <li>▪ Reset totalizer 3</li> <li>▪ Reset all totalizers</li> <li>▪ Flow override</li> <li>▪ Zero point adjustment</li> </ul>	Off

Parameter	Description	User interface / Selection / User entry	Factory setting
Active level	Define input signal level at which the assigned function is triggered.	<ul style="list-style-type: none"> <li>■ High</li> <li>■ Low</li> </ul>	High
Response time status input	Define the minimum amount of time the input signal level must be present before the selected function is triggered.	5 to 200 ms	50 ms

### 10.3.8 Configuring the current output

The **Current output** wizard guides you systematically through all the parameters that have to be set for configuring the current output.

#### Navigation





"Setup" menu → Current output

► Current output 1 to n	
Terminal number	→ 92
Signal mode	→ 92
Assign current output 1 to n	→ 93
Current span	→ 94
0/4 mA value	→ 94
20 mA value	→ 94
Fixed current	→ 94
Damping output 1 to n	→ 94
Failure mode	→ 95
Failure current	→ 95

#### Parameter overview with brief description

Parameter	Prerequisite	Description	User interface / Selection / User entry	Factory setting
Terminal number	–	Shows the terminal numbers used by the current output module.	<ul style="list-style-type: none"> <li>■ Not used</li> <li>■ 24-25 (I/O 2)</li> <li>■ 22-23 (I/O 3)</li> </ul>	–
Signal mode	–	Select the signal mode for the current output.	<ul style="list-style-type: none"> <li>■ Active *</li> <li>■ Passive *</li> </ul>	Active

Parameter	Prerequisite	Description	User interface / Selection / User entry	Factory setting
Assign current output 1 to n	-	Select process variable for current output.	<ul style="list-style-type: none"> <li>▪ Off*</li> <li>▪ Mass flow</li> <li>▪ Volume flow</li> <li>▪ Corrected volume flow*</li> <li>▪ Target mass flow*</li> <li>▪ Carrier mass flow*</li> <li>▪ Target volume flow*</li> <li>▪ Carrier volume flow*</li> <li>▪ Target corrected volume flow*</li> <li>▪ Carrier corrected volume flow*</li> <li>▪ Density</li> <li>▪ Reference density*</li> <li>▪ Reference density alternative*</li> <li>▪ GSV flow*</li> <li>▪ GSV flow alternative*</li> <li>▪ NSV flow*</li> <li>▪ NSV flow alternative*</li> <li>▪ S&amp;W volume flow*</li> <li>▪ Water cut*</li> <li>▪ Oil density*</li> <li>▪ Water density*</li> <li>▪ Oil mass flow*</li> <li>▪ Water mass flow*</li> <li>▪ Oil volume flow*</li> <li>▪ Water volume flow*</li> <li>▪ Oil corrected volume flow*</li> <li>▪ Water corrected volume flow*</li> <li>▪ Concentration*</li> <li>▪ Temperature</li> <li>▪ Carrier pipe temperature*</li> <li>▪ Electronic temperature</li> <li>▪ Oscillation frequency 0</li> <li>▪ Oscillation amplitude 0*</li> <li>▪ Frequency fluctuation 0*</li> <li>▪ Oscillation damping 0*</li> <li>▪ Oscillation damping fluctuation 0*</li> <li>▪ Signal asymmetry*</li> <li>▪ Exciter current 0*</li> <li>▪ HBSI*</li> <li>▪ Pressure*</li> <li>▪ Application specific output 0*</li> </ul>	Mass flow

Parameter	Prerequisite	Description	User interface / Selection / User entry	Factory setting
			<ul style="list-style-type: none"> <li>■ Application specific output 1 *</li> <li>■ Index inhomogeneous medium</li> <li>■ Index suspended bubbles *</li> </ul>	
Current span	–	Select current range for process value output and upper/lower level for alarm signal.	<ul style="list-style-type: none"> <li>■ 4...20 mA NAMUR (3.8...20.5 mA)</li> <li>■ 4...20 mA US (3.9...20.8 mA)</li> <li>■ 4...20 mA (4... 20.5 mA)</li> <li>■ 0...20 mA (0... 20.5 mA)</li> <li>■ Fixed current</li> </ul>	Country-specific: <ul style="list-style-type: none"> <li>■ 4...20 mA NAMUR (3.8...20.5 mA)</li> <li>■ 4...20 mA US (3.9...20.8 mA)</li> </ul>
0/4 mA value	In the <b>Current span</b> parameter (→  94), one of the following options is selected: <ul style="list-style-type: none"> <li>■ 4...20 mA NAMUR (3.8...20.5 mA)</li> <li>■ 4...20 mA US (3.9...20.8 mA)</li> <li>■ 4...20 mA (4... 20.5 mA)</li> <li>■ 0...20 mA (0... 20.5 mA)</li> </ul>	Enter 4 mA value.	Signed floating-point number	Country-specific: <ul style="list-style-type: none"> <li>■ 0 kg/h</li> <li>■ 0 lb/min</li> </ul>
20 mA value	One of the following options is selected in the <b>Current span</b> parameter (→  94): <ul style="list-style-type: none"> <li>■ 4...20 mA NAMUR (3.8...20.5 mA)</li> <li>■ 4...20 mA US (3.9...20.8 mA)</li> <li>■ 4...20 mA (4... 20.5 mA)</li> <li>■ 0...20 mA (0... 20.5 mA)</li> </ul>	Enter 20 mA value.	Signed floating-point number	Depends on country and nominal diameter
Fixed current	The <b>Fixed current</b> option is selected in the <b>Current span</b> parameter (→  94).	Defines the fixed output current.	0 to 22.5 mA	22.5 mA
Damping output 1 to n	A process variable is selected in the <b>Assign current output</b> parameter (→  93) and one of the following options is selected in the <b>Current span</b> parameter (→  94): <ul style="list-style-type: none"> <li>■ 4...20 mA NAMUR (3.8...20.5 mA)</li> <li>■ 4...20 mA US (3.9...20.8 mA)</li> <li>■ 4...20 mA (4... 20.5 mA)</li> <li>■ 0...20 mA (0... 20.5 mA)</li> </ul>	Set reaction time for output signal to fluctuations in the measured value.	0.0 to 999.9 s	1.0 s

Parameter	Prerequisite	Description	User interface / Selection / User entry	Factory setting
Failure mode	A process variable is selected in the <b>Assign current output</b> parameter (→ 93) and one of the following options is selected in the <b>Current span</b> parameter (→ 94): <ul style="list-style-type: none"> <li>▪ 4...20 mA NAMUR (3.8...20.5 mA)</li> <li>▪ 4...20 mA US (3.9...20.8 mA)</li> <li>▪ 4...20 mA (4... 20.5 mA)</li> <li>▪ 0...20 mA (0... 20.5 mA)</li> </ul>	Define output behavior in alarm condition.	<ul style="list-style-type: none"> <li>▪ Min.</li> <li>▪ Max.</li> <li>▪ Last valid value</li> <li>▪ Actual value</li> <li>▪ Defined value</li> </ul>	Max.
Failure current	The <b>Defined value</b> option is selected in the <b>Failure mode</b> parameter.	Enter current output value in alarm condition.	0 to 22.5 mA	22.5 mA

\* Visibility depends on order options or device settings

### 10.3.9 Configuring the pulse/frequency/switch output

The **Pulse/frequency/switch output** wizard guides you systematically through all the parameters that can be set for configuring the selected output type.

#### Navigation

"Setup" menu → Advanced setup → Pulse/frequency/switch output

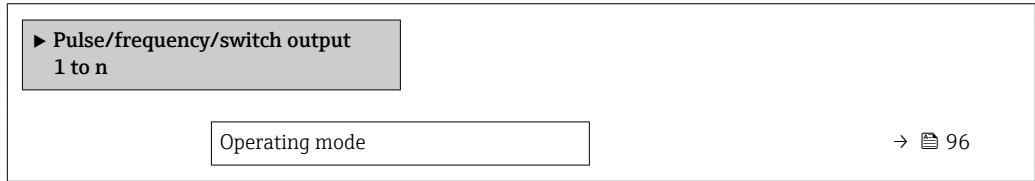

#### Parameter overview with brief description

Parameter	Description	Selection	Factory setting
Operating mode	Define the output as a pulse, frequency or switch output.	<ul style="list-style-type: none"> <li>■ Pulse</li> <li>■ Frequency</li> <li>■ Switch</li> </ul>	Pulse

#### Configuring the pulse output

#### Navigation

"Setup" menu → Pulse/frequency/switch output

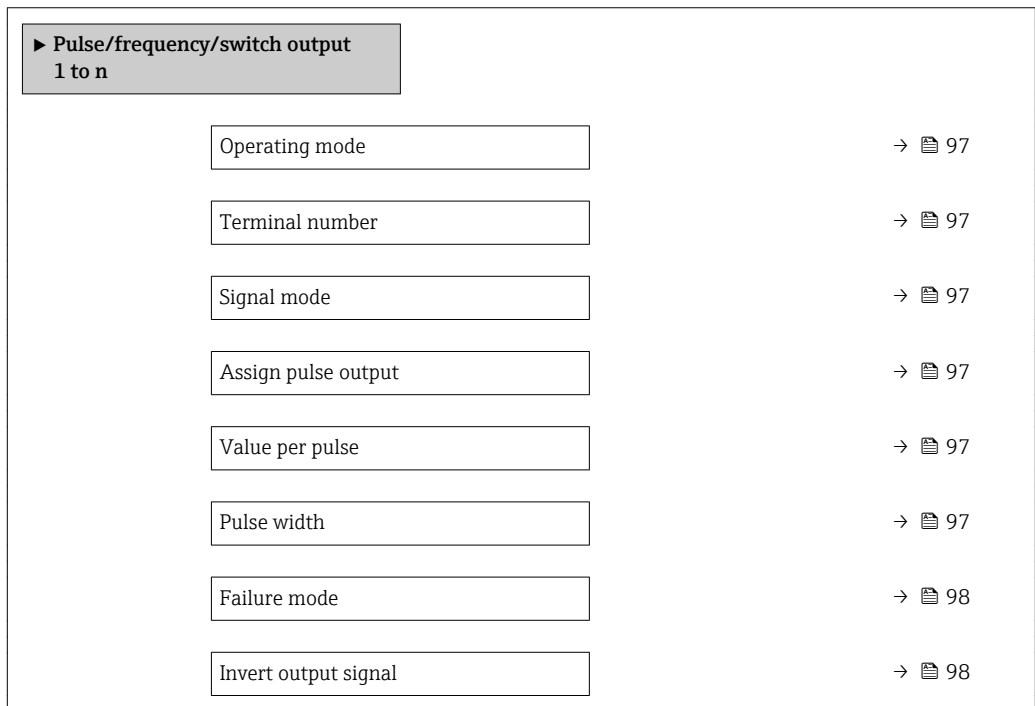



## Parameter overview with brief description

Parameter	Prerequisite	Description	Selection / User interface / User entry	Factory setting
Operating mode	–	Define the output as a pulse, frequency or switch output.	<ul style="list-style-type: none"> <li>▪ Pulse</li> <li>▪ Frequency</li> <li>▪ Switch</li> </ul>	Pulse
Terminal number	–	Shows the terminal numbers used by the PFS output module.	<ul style="list-style-type: none"> <li>▪ Not used</li> <li>▪ 24-25 (I/O 2)</li> <li>▪ 22-23 (I/O 3)</li> </ul>	–
Signal mode	–	Select the signal mode for the PFS output.	<ul style="list-style-type: none"> <li>▪ Passive</li> <li>▪ Active</li> <li>▪ Passive NAMUR</li> </ul>	Passive
Assign pulse output 1 to n	The <b>Pulse</b> option is selected in the <b>Operating mode</b> parameter parameter.	Select process variable for pulse output.	<ul style="list-style-type: none"> <li>▪ Off</li> <li>▪ Mass flow</li> <li>▪ Volume flow</li> <li>▪ Corrected volume flow<sup>*</sup></li> <li>▪ Target mass flow<sup>*</sup></li> <li>▪ Carrier mass flow<sup>*</sup></li> <li>▪ Target volume flow<sup>*</sup></li> <li>▪ Carrier volume flow<sup>*</sup></li> <li>▪ Target corrected volume flow<sup>*</sup></li> <li>▪ Carrier corrected volume flow<sup>*</sup></li> <li>▪ GSV flow<sup>*</sup></li> <li>▪ GSV flow alternative<sup>*</sup></li> <li>▪ NSV flow<sup>*</sup></li> <li>▪ NSV flow alternative<sup>*</sup></li> <li>▪ S&amp;W volume flow<sup>*</sup></li> <li>▪ Oil mass flow<sup>*</sup></li> <li>▪ Water mass flow<sup>*</sup></li> <li>▪ Oil volume flow<sup>*</sup></li> <li>▪ Water volume flow<sup>*</sup></li> <li>▪ Oil corrected volume flow<sup>*</sup></li> <li>▪ Water corrected volume flow<sup>*</sup></li> </ul>	Off
Pulse scaling	The <b>Pulse</b> option is selected in the <b>Operating mode</b> parameter (→ 96) and a process variable is selected in the <b>Assign pulse output</b> parameter (→ 97).	Enter quantity for measured value at which a pulse is output.	Positive floating point number	Depends on country and nominal diameter
Pulse width	The <b>Pulse</b> option is selected in the <b>Operating mode</b> parameter (→ 96) and a process variable is selected in the <b>Assign pulse output</b> parameter (→ 97).	Define time width of the output pulse.	0.05 to 2 000 ms	100 ms

Parameter	Prerequisite	Description	Selection / User interface / User entry	Factory setting
Failure mode	The <b>Pulse</b> option is selected in the <b>Operating mode</b> parameter (→ 96) and a process variable is selected in the <b>Assign pulse output</b> parameter (→ 97).	Define output behavior in alarm condition.	<ul style="list-style-type: none"> <li>■ Actual value</li> <li>■ No pulses</li> </ul>	No pulses
Invert output signal	–	Invert the output signal.	<ul style="list-style-type: none"> <li>■ No</li> <li>■ Yes</li> </ul>	No

\* Visibility depends on order options or device settings

## Configuring the frequency output

### Navigation

"Setup" menu → Pulse/frequency/switch output

► Pulse/frequency/switch output 1 to n	
Operating mode	→ 99
Terminal number	→ 99
Signal mode	→ 99
Assign frequency output	→ 100
Minimum frequency value	→ 101
Maximum frequency value	→ 101
Measuring value at minimum frequency	→ 101
Measuring value at maximum frequency	→ 101
Failure mode	→ 101
Failure frequency	→ 101
Invert output signal	→ 101

### Parameter overview with brief description

Parameter	Prerequisite	Description	Selection / User interface / User entry	Factory setting
Operating mode	–	Define the output as a pulse, frequency or switch output.	<ul style="list-style-type: none"> <li>▪ Pulse</li> <li>▪ Frequency</li> <li>▪ Switch</li> </ul>	Pulse
Terminal number	–	Shows the terminal numbers used by the PFS output module.	<ul style="list-style-type: none"> <li>▪ Not used</li> <li>▪ 24-25 (I/O 2)</li> <li>▪ 22-23 (I/O 3)</li> </ul>	–
Signal mode	–	Select the signal mode for the PFS output.	<ul style="list-style-type: none"> <li>▪ Passive</li> <li>▪ Active</li> <li>▪ Passive NAMUR</li> </ul>	Passive

Parameter	Prerequisite	Description	Selection / User interface / User entry	Factory setting
Assign frequency output	The <b>Frequency</b> option is selected in the <b>Operating mode</b> parameter (→ 96).	Select process variable for frequency output.	<ul style="list-style-type: none"> <li>■ Off</li> <li>■ Mass flow</li> <li>■ Volume flow</li> <li>■ Corrected volume flow</li> <li>■ Target mass flow *</li> <li>■ Carrier mass flow *</li> <li>■ Target volume flow *</li> <li>■ Carrier volume flow *</li> <li>■ Target corrected volume flow *</li> <li>■ Carrier corrected volume flow *</li> <li>■ Density</li> <li>■ Reference density</li> <li>■ Reference density alternative *</li> <li>■ GSV flow *</li> <li>■ GSV flow alternative *</li> <li>■ NSV flow *</li> <li>■ NSV flow alternative *</li> <li>■ S&amp;W volume flow *</li> <li>■ Water cut *</li> <li>■ Oil density *</li> <li>■ Water density *</li> <li>■ Oil mass flow</li> <li>■ Water mass flow *</li> <li>■ Oil volume flow *</li> <li>■ Water volume flow *</li> <li>■ Oil corrected volume flow *</li> <li>■ Water corrected volume flow *</li> <li>■ Concentration *</li> <li>■ Temperature</li> <li>■ Carrier pipe temperature *</li> <li>■ Electronic temperature</li> <li>■ Oscillation frequency 0</li> <li>■ Oscillation amplitude 0 *</li> <li>■ Frequency fluctuation 0 *</li> <li>■ Oscillation damping 0 *</li> <li>■ Oscillation damping fluctuation 0 *</li> <li>■ Signal asymmetry *</li> <li>■ Exciter current 0 *</li> <li>■ HBSI *</li> <li>■ Pressure</li> <li>■ Application specific output 0 *</li> </ul>	Off

Parameter	Prerequisite	Description	Selection / User interface / User entry	Factory setting
			<ul style="list-style-type: none"> <li>▪ Application specific output 1 *</li> <li>▪ Index inhomogeneous medium</li> <li>▪ Index suspended bubbles *</li> </ul>	
Minimum frequency value	The <b>Frequency</b> option is selected in the <b>Operating mode</b> parameter (→ 96) and a process variable is selected in the <b>Assign frequency output</b> parameter (→ 100).	Enter minimum frequency.	0.0 to 10 000.0 Hz	0.0 Hz
Maximum frequency value	The <b>Frequency</b> option is selected in the <b>Operating mode</b> parameter (→ 96) and a process variable is selected in the <b>Assign frequency output</b> parameter (→ 100).	Enter maximum frequency.	0.0 to 10 000.0 Hz	10 000.0 Hz
Measuring value at minimum frequency	The <b>Frequency</b> option is selected in the <b>Operating mode</b> parameter (→ 96) and a process variable is selected in the <b>Assign frequency output</b> parameter (→ 100).	Enter measured value for minimum frequency.	Signed floating-point number	Depends on country and nominal diameter
Measuring value at maximum frequency	The <b>Frequency</b> option is selected in the <b>Operating mode</b> parameter (→ 96) and a process variable is selected in the <b>Assign frequency output</b> parameter (→ 100).	Enter measured value for maximum frequency.	Signed floating-point number	Depends on country and nominal diameter
Failure mode	The <b>Frequency</b> option is selected in the <b>Operating mode</b> parameter (→ 96) and a process variable is selected in the <b>Assign frequency output</b> parameter (→ 100).	Define output behavior in alarm condition.	<ul style="list-style-type: none"> <li>▪ Actual value</li> <li>▪ Defined value</li> <li>▪ 0 Hz</li> </ul>	0 Hz
Failure frequency	The <b>Frequency</b> option is selected in the <b>Operating mode</b> parameter (→ 96) and a process variable is selected in the <b>Assign frequency output</b> parameter (→ 100).	Enter frequency output value in alarm condition.	0.0 to 12 500.0 Hz	0.0 Hz
Invert output signal	–	Invert the output signal.	<ul style="list-style-type: none"> <li>▪ No</li> <li>▪ Yes</li> </ul>	No

\* Visibility depends on order options or device settings

### Configuring the switch output

#### Navigation

"Setup" menu → Pulse/frequency/switch output

**► Pulse/frequency/switch output**  
 1 to n

Operating mode	→  102
Terminal number	→  102
Signal mode	→  103
Switch output function	→  103
Assign diagnostic behavior	→  103
Assign limit	→  104
Assign flow direction check	→  104
Assign status	→  105
Switch-on value	→  105
Switch-off value	→  105
Switch-on delay	→  105
Switch-off delay	→  105
Failure mode	→  105
Invert output signal	→  105

#### Parameter overview with brief description

Parameter	Prerequisite	Description	Selection / User interface / User entry	Factory setting
Operating mode	–	Define the output as a pulse, frequency or switch output.	<ul style="list-style-type: none"> <li>■ Pulse</li> <li>■ Frequency</li> <li>■ Switch</li> </ul>	Pulse
Terminal number	–	Shows the terminal numbers used by the PFS output module.	<ul style="list-style-type: none"> <li>■ Not used</li> <li>■ 24-25 (I/O 2)</li> <li>■ 22-23 (I/O 3)</li> </ul>	–

Parameter	Prerequisite	Description	Selection / User interface / User entry	Factory setting
Signal mode	–	Select the signal mode for the PFS output.	<ul style="list-style-type: none"> <li>▪ Passive</li> <li>▪ Active</li> <li>▪ Passive NAMUR</li> </ul>	Passive
Switch output function	The <b>Switch</b> option is selected in the <b>Operating mode</b> parameter.	Select function for switch output.	<ul style="list-style-type: none"> <li>▪ Off</li> <li>▪ On</li> <li>▪ Diagnostic behavior</li> <li>▪ Limit</li> <li>▪ Flow direction check</li> <li>▪ Status</li> </ul>	Off
Assign diagnostic behavior	<ul style="list-style-type: none"> <li>▪ In the <b>Operating mode</b> parameter, the <b>Switch</b> option is selected.</li> <li>▪ In the <b>Switch output function</b> parameter, the <b>Diagnostic behavior</b> option is selected.</li> </ul>	Select diagnostic behavior for switch output.	<ul style="list-style-type: none"> <li>▪ Alarm</li> <li>▪ Alarm or warning</li> <li>▪ Warning</li> </ul>	Alarm

Parameter	Prerequisite	Description	Selection / User interface / User entry	Factory setting
Assign limit	<ul style="list-style-type: none"> <li>▪ The <b>Switch</b> option is selected in the <b>Operating mode</b> parameter.</li> <li>▪ The <b>Limit</b> option is selected in the <b>Switch output function</b> parameter.</li> </ul>	Select process variable for limit function.	<ul style="list-style-type: none"> <li>▪ Mass flow</li> <li>▪ Volume flow</li> <li>▪ Corrected volume flow *</li> <li>▪ Target mass flow *</li> <li>▪ Carrier mass flow *</li> <li>▪ Target volume flow *</li> <li>▪ Carrier volume flow *</li> <li>▪ Target corrected volume flow *</li> <li>▪ Carrier corrected volume flow *</li> <li>▪ Density</li> <li>▪ Reference density *</li> <li>▪ Reference density alternative *</li> <li>▪ GSV flow *</li> <li>▪ GSV flow alternative *</li> <li>▪ NSV flow *</li> <li>▪ NSV flow alternative *</li> <li>▪ S&amp;W volume flow *</li> <li>▪ Water cut *</li> <li>▪ Oil density *</li> <li>▪ Water density *</li> <li>▪ Oil mass flow *</li> <li>▪ Water mass flow *</li> <li>▪ Oil volume flow *</li> <li>▪ Water volume flow *</li> <li>▪ Oil corrected volume flow *</li> <li>▪ Water corrected volume flow *</li> <li>▪ Concentration *</li> <li>▪ Temperature</li> <li>▪ Totalizer 1</li> <li>▪ Totalizer 2</li> <li>▪ Totalizer 3</li> <li>▪ Oscillation damping</li> <li>▪ Pressure</li> <li>▪ Application specific output 0 *</li> <li>▪ Application specific output 1 *</li> <li>▪ Index inhomogeneous medium</li> <li>▪ Index suspended bubbles *</li> </ul>	Mass flow
Assign flow direction check	<ul style="list-style-type: none"> <li>▪ The <b>Switch</b> option is selected in the <b>Operating mode</b> parameter.</li> <li>▪ The <b>Flow direction check</b> option is selected in the <b>Switch output function</b> parameter.</li> </ul>	Select process variable for flow direction monitoring.	<ul style="list-style-type: none"> <li>▪ Off</li> <li>▪ Volume flow</li> <li>▪ Mass flow</li> <li>▪ Corrected volume flow *</li> </ul>	Mass flow



Parameter	Prerequisite	Description	Selection / User interface / User entry	Factory setting
Assign status	<ul style="list-style-type: none"> <li>The <b>Switch</b> option is selected in the <b>Operating mode</b> parameter.</li> <li>The <b>Status</b> option is selected in the <b>Switch output function</b> parameter.</li> </ul>	Select device status for switch output.	<ul style="list-style-type: none"> <li>Partially filled pipe detection</li> <li>Low flow cut off</li> </ul>	Partially filled pipe detection
Switch-on value	<ul style="list-style-type: none"> <li>The <b>Switch</b> option is selected in the <b>Operating mode</b> parameter.</li> <li>The <b>Limit</b> option is selected in the <b>Switch output function</b> parameter.</li> </ul>	Enter measured value for the switch-on point.	Signed floating-point number	Country-specific: <ul style="list-style-type: none"> <li>0 kg/h</li> <li>0 lb/min</li> </ul>
Switch-off value	<ul style="list-style-type: none"> <li>The <b>Switch</b> option is selected in the <b>Operating mode</b> parameter.</li> <li>The <b>Limit</b> option is selected in the <b>Switch output function</b> parameter.</li> </ul>	Enter measured value for the switch-off point.	Signed floating-point number	Country-specific: <ul style="list-style-type: none"> <li>0 kg/h</li> <li>0 lb/min</li> </ul>
Switch-on delay	<ul style="list-style-type: none"> <li>The <b>Switch</b> option is selected in the <b>Operating mode</b> parameter.</li> <li>The <b>Limit</b> option is selected in the <b>Switch output function</b> parameter.</li> </ul>	Define delay for the switch-on of status output.	0.0 to 100.0 s	0.0 s
Switch-off delay	<ul style="list-style-type: none"> <li>The <b>Switch</b> option is selected in the <b>Operating mode</b> parameter.</li> <li>The <b>Limit</b> option is selected in the <b>Switch output function</b> parameter.</li> </ul>	Define delay for the switch-off of status output.	0.0 to 100.0 s	0.0 s
Failure mode	–	Define output behavior in alarm condition.	<ul style="list-style-type: none"> <li>Actual status</li> <li>Open</li> <li>Closed</li> </ul>	Open
Invert output signal	–	Invert the output signal.	<ul style="list-style-type: none"> <li>No</li> <li>Yes</li> </ul>	No

\* Visibility depends on order options or device settings

### 10.3.10 Configuring the relay output

The **Relay output** wizard guides the user systematically through all the parameters that have to be set for configuring the relay output.

#### Navigation

"Setup" menu → Relay output 1 to n







▶ RelaisOutput 1 to n

Switch output function

→ 106

Assign flow direction check

→ 106

Assign limit	→  107
Assign diagnostic behavior	→  107
Assign status	→  107
Switch-off value	→  108
Switch-on value	→  108
Failure mode	→  108

### Parameter overview with brief description

Parameter	Prerequisite	Description	Selection / User interface / User entry	Factory setting
Relay output function	–	Select the function for the relay output.	<ul style="list-style-type: none"> <li>■ Closed</li> <li>■ Open</li> <li>■ Diagnostic behavior</li> <li>■ Limit</li> <li>■ Flow direction check</li> <li>■ Digital Output</li> </ul>	Closed
Terminal number	–	Shows the terminal numbers used by the relay output module.	<ul style="list-style-type: none"> <li>■ Not used</li> <li>■ 24-25 (I/O 2)</li> <li>■ 22-23 (I/O 3)</li> </ul>	–
Assign flow direction check	In the <b>Relay output function</b> parameter, the <b>Flow direction check</b> option is selected.	Select process variable for flow direction monitoring.	<ul style="list-style-type: none"> <li>■ Off</li> <li>■ Volume flow</li> <li>■ Mass flow</li> <li>■ Corrected volume flow<sup>*</sup></li> </ul>	Mass flow

Parameter	Prerequisite	Description	Selection / User interface / User entry	Factory setting
Assign limit	The <b>Limit</b> option is selected in the <b>Relay output function</b> parameter.	Select process variable for limit function.	<ul style="list-style-type: none"> <li>▪ Mass flow</li> <li>▪ Volume flow</li> <li>▪ Corrected volume flow<sup>*</sup></li> <li>▪ Target mass flow<sup>*</sup></li> <li>▪ Carrier mass flow<sup>*</sup></li> <li>▪ Target volume flow<sup>*</sup></li> <li>▪ Carrier volume flow<sup>*</sup></li> <li>▪ Target corrected volume flow<sup>*</sup></li> <li>▪ Carrier corrected volume flow<sup>*</sup></li> <li>▪ Density</li> <li>▪ Reference density<sup>*</sup></li> <li>▪ Reference density alternative<sup>*</sup></li> <li>▪ GSV flow<sup>*</sup></li> <li>▪ GSV flow alternative<sup>*</sup></li> <li>▪ NSV flow<sup>*</sup></li> <li>▪ NSV flow alternative<sup>*</sup></li> <li>▪ S&amp;W volume flow<sup>*</sup></li> <li>▪ Water cut<sup>*</sup></li> <li>▪ Oil density<sup>*</sup></li> <li>▪ Water density<sup>*</sup></li> <li>▪ Oil mass flow<sup>*</sup></li> <li>▪ Water mass flow<sup>*</sup></li> <li>▪ Oil volume flow<sup>*</sup></li> <li>▪ Water volume flow<sup>*</sup></li> <li>▪ Oil corrected volume flow<sup>*</sup></li> <li>▪ Water corrected volume flow<sup>*</sup></li> <li>▪ Concentration<sup>*</sup></li> <li>▪ Temperature</li> <li>▪ Totalizer 1</li> <li>▪ Totalizer 2</li> <li>▪ Totalizer 3</li> <li>▪ Oscillation damping</li> <li>▪ Pressure</li> <li>▪ Application specific output 0<sup>*</sup></li> <li>▪ Application specific output 1<sup>*</sup></li> <li>▪ Index inhomogeneous medium</li> <li>▪ Index suspended bubbles<sup>*</sup></li> </ul>	Mass flow
Assign diagnostic behavior	In the <b>Relay output function</b> parameter, the <b>Diagnostic behavior</b> option is selected.	Select diagnostic behavior for switch output.	<ul style="list-style-type: none"> <li>▪ Alarm</li> <li>▪ Alarm or warning</li> <li>▪ Warning</li> </ul>	Alarm
Assign status	In the <b>Relay output function</b> parameter, the <b>Digital Output</b> option is selected.	Select device status for switch output.	<ul style="list-style-type: none"> <li>▪ Partially filled pipe detection</li> <li>▪ Low flow cut off</li> </ul>	Partially filled pipe detection

Parameter	Prerequisite	Description	Selection / User interface / User entry	Factory setting
Switch-off value	In the <b>Relay output function</b> parameter, the <b>Limit</b> option is selected.	Enter measured value for the switch-off point.	Signed floating-point number	Country-specific: ■ 0 kg/h ■ 0 lb/min
Switch-off delay	In the <b>Relay output function</b> parameter, the <b>Limit</b> option is selected.	Define delay for the switch-off of status output.	0.0 to 100.0 s	0.0 s
Switch-on value	The <b>Limit</b> option is selected in the <b>Relay output function</b> parameter.	Enter measured value for the switch-on point.	Signed floating-point number	Country-specific: ■ 0 kg/h ■ 0 lb/min
Switch-on delay	In the <b>Relay output function</b> parameter, the <b>Limit</b> option is selected.	Define delay for the switch-on of status output.	0.0 to 100.0 s	0.0 s
Failure mode	–	Define output behavior in alarm condition.	<ul style="list-style-type: none"> <li>■ Actual status</li> <li>■ Open</li> <li>■ Closed</li> </ul>	Open

\* Visibility depends on order options or device settings

### 10.3.11 Configuring the double pulse output

The **Double pulse output** submenu guides the user systematically through all the parameters that have to be set for configuring the double pulse output.

#### Navigation

"Setup" menu → Double pulse output

► Double pulse output	
Master terminal number	→ ⓘ 109
Slave terminal number	→ ⓘ 109
Signal mode	→ ⓘ 109
Assign pulse output 1	→ ⓘ 109
Measuring mode	→ ⓘ 109
Value per pulse	→ ⓘ 109
Pulse width	→ ⓘ 109
Failure mode	→ ⓘ 109
Invert output signal	→ ⓘ 109

### Parameter overview with brief description

Parameter	Description	Selection / User interface / User entry	Factory setting
Signal mode	Select the signal mode for the double pulse output.	<ul style="list-style-type: none"> <li>■ Passive</li> <li>■ Active</li> <li>■ Passive NAMUR</li> </ul>	Passive
Master terminal number	Shows the terminal numbers used by the master of the double pulse output module.	<ul style="list-style-type: none"> <li>■ Not used</li> <li>■ 24-25 (I/O 2)</li> <li>■ 22-23 (I/O 3)</li> </ul>	–
Slave terminal number	Shows the terminal numbers used by the slave of the double pulse output module.	<ul style="list-style-type: none"> <li>■ Not used</li> <li>■ 24-25 (I/O 2)</li> <li>■ 22-23 (I/O 3)</li> </ul>	–
Assign pulse output 1	Select process variable for pulse output.	<ul style="list-style-type: none"> <li>■ Off</li> <li>■ Mass flow</li> <li>■ Volume flow</li> <li>■ Corrected volume flow *</li> <li>■ Target mass flow *</li> <li>■ Carrier mass flow *</li> <li>■ Target volume flow *</li> <li>■ Carrier volume flow *</li> <li>■ Target corrected volume flow *</li> <li>■ Carrier corrected volume flow *</li> <li>■ GSV flow *</li> <li>■ GSV flow alternative *</li> <li>■ NSV flow *</li> <li>■ NSV flow alternative *</li> <li>■ S&amp;W volume flow *</li> <li>■ Oil mass flow *</li> <li>■ Water mass flow *</li> <li>■ Oil volume flow *</li> <li>■ Water volume flow *</li> <li>■ Oil corrected volume flow *</li> <li>■ Water corrected volume flow *</li> </ul>	Off
Measuring mode	Select measuring mode for pulse output.	<ul style="list-style-type: none"> <li>■ Forward flow</li> <li>■ Forward/Reverse flow</li> <li>■ Reverse flow</li> <li>■ Reverse flow compensation</li> </ul>	Forward flow
Value per pulse	Enter measured value at which a pulse is output.	Signed floating-point number	Depends on country and nominal diameter
Pulse width	Define time width of the output pulse.	0.5 to 2 000 ms	0.5 ms
Failure mode	Define output behavior in alarm condition.	<ul style="list-style-type: none"> <li>■ Actual value</li> <li>■ No pulses</li> </ul>	No pulses
Invert output signal	Invert the output signal.	<ul style="list-style-type: none"> <li>■ No</li> <li>■ Yes</li> </ul>	No

\* Visibility depends on order options or device settings

### 10.3.12 Configuring the local display

The **Display** wizard guides you systematically through all the parameters that can be configured for configuring the local display.

**Navigation**

"Setup" menu → Display



► Display	
Format display	→ 111
Value 1 display	→ 112
0% bargraph value 1	→ 113
100% bargraph value 1	→ 113
Value 2 display	→ 113
Value 3 display	→ 113
0% bargraph value 3	→ 113
100% bargraph value 3	→ 113
Value 4 display	→ 113

**Parameter overview with brief description**

<b>Parameter</b>	<b>Prerequisite</b>	<b>Description</b>	<b>Selection / User entry</b>	<b>Factory setting</b>
Format display	A local display is provided.	Select how measured values are shown on the display.	<ul style="list-style-type: none"><li>▪ 1 value, max. size</li><li>▪ 1 bargraph + 1 value</li><li>▪ 2 values</li><li>▪ 1 value large + 2 values</li><li>▪ 4 values</li></ul>	1 value, max. size

Parameter	Prerequisite	Description	Selection / User entry	Factory setting
Value 1 display	A local display is provided.	Select the measured value that is shown on the local display.	<ul style="list-style-type: none"> <li>■ Mass flow</li> <li>■ Volume flow</li> <li>■ Corrected volume flow *</li> <li>■ Target mass flow *</li> <li>■ Carrier mass flow *</li> <li>■ Target volume flow *</li> <li>■ Carrier volume flow *</li> <li>■ Target corrected volume flow *</li> <li>■ Carrier corrected volume flow *</li> <li>■ Density</li> <li>■ Reference density *</li> <li>■ Reference density alternative *</li> <li>■ GSV flow *</li> <li>■ GSV flow alternative *</li> <li>■ NSV flow *</li> <li>■ NSV flow alternative *</li> <li>■ S&amp;W volume flow *</li> <li>■ Water cut *</li> <li>■ Oil density *</li> <li>■ Water density *</li> <li>■ Oil mass flow *</li> <li>■ Water mass flow *</li> <li>■ Oil volume flow *</li> <li>■ Water volume flow *</li> <li>■ Oil corrected volume flow *</li> <li>■ Water corrected volume flow *</li> <li>■ Weighted density average *</li> <li>■ Weighted temperature average *</li> <li>■ Concentration *</li> <li>■ Temperature</li> <li>■ Carrier pipe temperature *</li> <li>■ Electronic temperature</li> <li>■ Oscillation frequency 0</li> <li>■ Oscillation amplitude 0 *</li> <li>■ Frequency fluctuation 0 *</li> <li>■ Oscillation damping 0 *</li> <li>■ Oscillation damping fluctuation 0 *</li> <li>■ Signal asymmetry *</li> <li>■ Exciter current 0 *</li> <li>■ Totalizer 1</li> <li>■ Totalizer 2</li> </ul>	Mass flow



Parameter	Prerequisite	Description	Selection / User entry	Factory setting
			<ul style="list-style-type: none"> <li>▪ Totalizer 3</li> <li>▪ Current output 1 *</li> <li>▪ Current output 2 *</li> <li>▪ Pressure</li> <li>▪ Application specific output 1 *</li> <li>▪ Index inhomogeneous medium</li> <li>▪ Application specific output 0 *</li> <li>▪ Index suspended bubbles*</li> </ul>	
0% bargraph value 1	A local display is provided.	Enter 0% value for bar graph display.	Signed floating-point number	Country-specific: <ul style="list-style-type: none"> <li>▪ 0 kg/h</li> <li>▪ 0 lb/min</li> </ul>
100% bargraph value 1	A local display is provided.	Enter 100% value for bar graph display.	Signed floating-point number	Depends on country and nominal diameter
Value 2 display	A local display is provided.	Select the measured value that is shown on the local display.	For the picklist, see the <b>Value 2 display</b> parameter (→  113)	None
Value 3 display	A local display is provided.	Select the measured value that is shown on the local display.	For the picklist, see the <b>Value 2 display</b> parameter (→  113)	None
0% bargraph value 3	A selection was made in the <b>Value 3 display</b> parameter.	Enter 0% value for bar graph display.	Signed floating-point number	Country-specific: <ul style="list-style-type: none"> <li>▪ 0 kg/h</li> <li>▪ 0 lb/min</li> </ul>
100% bargraph value 3	A selection was made in the <b>Value 3 display</b> parameter.	Enter 100% value for bar graph display.	Signed floating-point number	0
Value 4 display	A local display is provided.	Select the measured value that is shown on the local display.	For the picklist, see the <b>Value 2 display</b> parameter (→  113)	None





\* Visibility depends on order options or device settings

### 10.3.13 Configuring the low flow cut off



The **Low flow cut off** wizard systematically guides the user through all the parameters that must be set to configure low flow cut off.

#### Navigation

"Setup" menu → Low flow cut off

► Low flow cut off	
Assign process variable	→  114
On value low flow cutoff	→  114
Off value low flow cutoff	→  114
Pressure shock suppression	→  114

#### Parameter overview with brief description

Parameter	Prerequisite	Description	Selection / User entry	Factory setting
Assign process variable	–	Select process variable for low flow cut off.	<ul style="list-style-type: none"> <li>■ Off</li> <li>■ Mass flow</li> <li>■ Volume flow</li> <li>■ Corrected volume flow<sup>*</sup></li> </ul>	Mass flow
On value low flow cutoff	A process variable is selected in the <b>Assign process variable</b> parameter (→  114).	Enter on value for low flow cut off.	Positive floating-point number	Depends on country and nominal diameter
Off value low flow cutoff	A process variable is selected in the <b>Assign process variable</b> parameter (→  114).	Enter off value for low flow cut off.	0 to 100.0 %	50 %
Pressure shock suppression	A process variable is selected in the <b>Assign process variable</b> parameter (→  114).	Enter time frame for signal suppression (= active pressure shock suppression).	0 to 100 s	0 s





\* Visibility depends on order options or device settings

### 10.3.14 Configuring the partial filled pipe detection



The **Partial filled pipe detection** wizard guides you systematically through all parameters that have to be set for configuring the monitoring of the pipe filling.

#### Navigation

"Setup" menu → Partially filled pipe detection

▶ Partially filled pipe detection	
Assign process variable	→  115
Low value partial filled pipe detection	→  115
High value partial filled pipe detection	→  115
Response time part. filled pipe detect.	→  115

#### Parameter overview with brief description

Parameter	Prerequisite	Description	Selection / User entry	Factory setting
Assign process variable	–	Select process variable for partially filled pipe detection.	<ul style="list-style-type: none"> <li>▪ Off</li> <li>▪ Density</li> <li>▪ Reference density</li> </ul>	Off
Low value partial filled pipe detection	A process variable is selected in the <b>Assign process variable</b> parameter (→  115).	Enter lower limit value for deactivating partially filled pipe detection.	Signed floating-point number	200
High value partial filled pipe detection	A process variable is selected in the <b>Assign process variable</b> parameter (→  115).	Enter upper limit value for deactivating partially filled pipe detection.	Signed floating-point number	6000
Response time part. filled pipe detect.	A process variable is selected in the <b>Assign process variable</b> parameter (→  115).	Enter time before diagnostic message is displayed for partially filled pipe detection.	0 to 100 s	1 s

## 10.4 Advanced settings

The **Advanced setup** submenu together with its submenus contains parameters for specific settings.

*Navigation to the "Advanced setup" submenu*

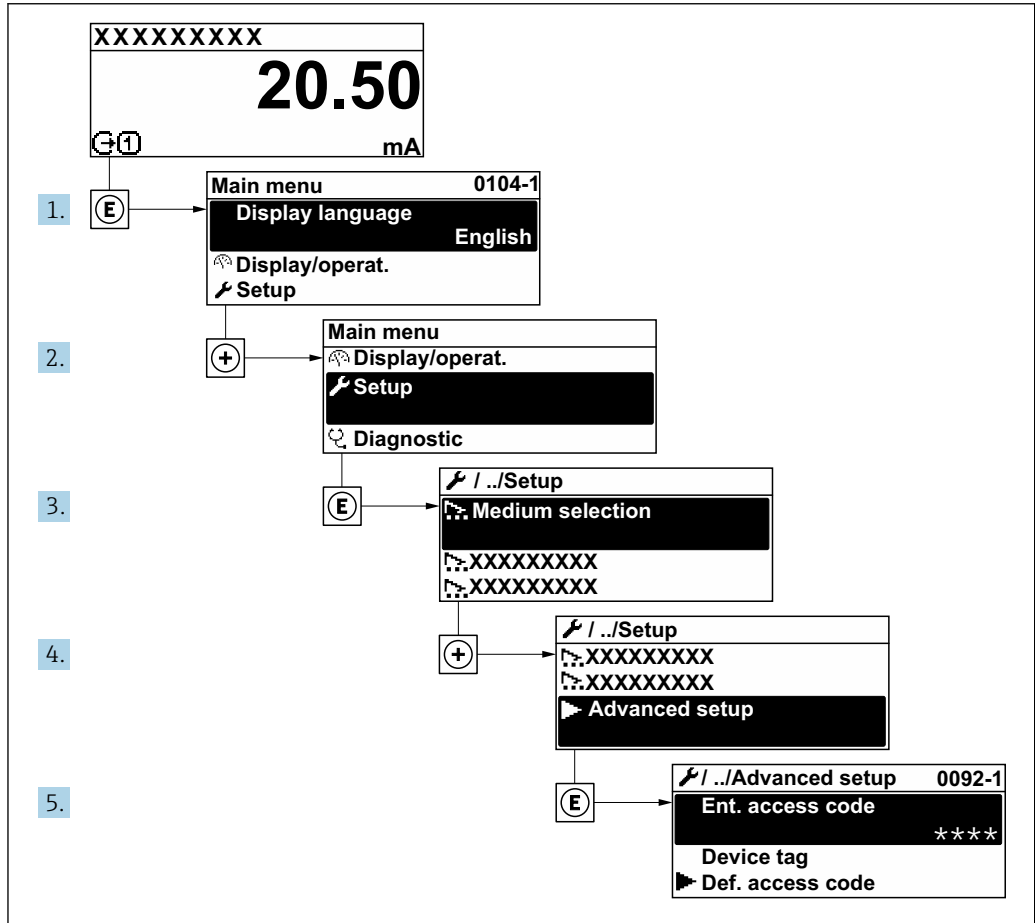

A0032223-EN

**i** The number of submenus and parameters can vary depending on the device version. Certain submenus and parameters in these submenus are not described in the Operation Instructions. Instead a description is provided in the Special Documentation for the device (→ "Supplementary documentation" section).

### Navigation

"Setup" menu → Advanced setup

▶ <b>Advanced setup</b>	
Enter access code	→ 117
▶ <b>Calculated values</b>	→ 117
▶ <b>Sensor adjustment</b>	→ 118

▶ Totalizer 1 to n	→ 📄 119
▶ Custody transfer activation	
▶ Custody transfer deactivation	
▶ Display	→ 📄 122
▶ WLAN settings	→ 📄 127
▶ Concentration	
▶ Heartbeat setup	
▶ Configuration backup	→ 📄 129
▶ Administration	→ 📄 130

### 10.4.1 Using the parameter to enter the access code

#### Navigation

"Setup" menu → Advanced setup

#### Parameter overview with brief description

Parameter	Description	User entry
Enter access code	Enter access code to disable write protection of parameters.	Max. 16-digit character string comprising numbers, letters and special characters





### 10.4.2 Calculated values

The **Calculated values** submenu contains parameters for calculating the corrected volume flow.

#### Navigation

"Setup" menu → Advanced setup → Calculated values

▶ Calculated values	
▶ Corrected volume flow calculation	
Corrected volume flow calculation	→ 📄 118
External reference density	→ 📄 118

Fixed reference density	→  118
Reference temperature	→  118
Linear expansion coefficient	→  118
Square expansion coefficient	→  118

### Parameter overview with brief description

Parameter	Prerequisite	Description	Selection / User interface / User entry	Factory setting
Corrected volume flow calculation	–	Select reference density for calculating the corrected volume flow.	<ul style="list-style-type: none"> <li>■ Fixed reference density</li> <li>■ Calculated reference density</li> <li>■ Current input 1<sup>*</sup></li> <li>■ Current input 2<sup>*</sup></li> </ul>	Calculated reference density
External reference density	In the <b>Corrected volume flow calculation</b> parameter, the <b>External reference density</b> option is selected.	Shows external reference density.	Floating point number with sign	–
Fixed reference density	The <b>Fixed reference density</b> option is selected in the <b>Corrected volume flow calculation</b> parameter.	Enter fixed value for reference density.	Positive floating-point number	1 kg/Nl
Reference temperature	The <b>Calculated reference density</b> option is selected in the <b>Corrected volume flow calculation</b> parameter.	Enter reference temperature for calculating the reference density.	–273.15 to 99 999 °C	Country-specific: <ul style="list-style-type: none"> <li>■ +20 °C</li> <li>■ +68 °F</li> </ul>
Linear expansion coefficient	The <b>Calculated reference density</b> option is selected in the <b>Corrected volume flow calculation</b> parameter.	Enter linear, medium-specific expansion coefficient for calculating the reference density.	Signed floating-point number	0.0 1/K
Square expansion coefficient	The <b>Calculated reference density</b> option is selected in the <b>Corrected volume flow calculation</b> parameter.	For media with a non-linear expansion pattern: enter the quadratic, medium-specific expansion coefficient for calculating the reference density.	Signed floating-point number	0.0 1/K <sup>2</sup>

\* Visibility depends on order options or device settings

### 10.4.3 Carrying out a sensor adjustment

The **Sensor adjustment** submenu contains parameters that pertain to the functionality of the sensor.

**Navigation**

"Setup" menu → Advanced setup → Sensor adjustment

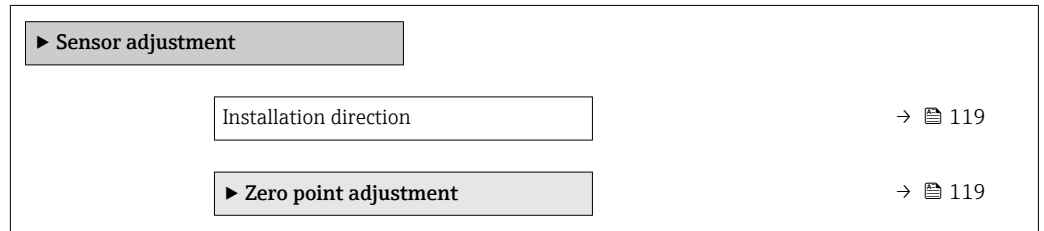

**Parameter overview with brief description**

Parameter	Description	Selection	Factory setting
Installation direction	Set sign of flow direction to match the direction of the arrow on the sensor.	<ul style="list-style-type: none"> <li>▪ Flow in arrow direction</li> <li>▪ Flow against arrow direction</li> </ul>	Flow in arrow direction

**Zero point adjustment**

All measuring devices are calibrated in accordance with state-of-the-art technology. Calibration takes place under reference conditions → 196. Therefore, a zero point adjustment in the field is generally not required.

Experience shows that zero point adjustment is advisable only in special cases:

- To achieve maximum measuring accuracy even with low flow rates.
- Under extreme process or operating conditions (e.g. very high process temperatures or very high-viscosity fluids).

**Navigation**

"Setup" menu → Advanced setup → Sensor adjustment → Zero point adjustment

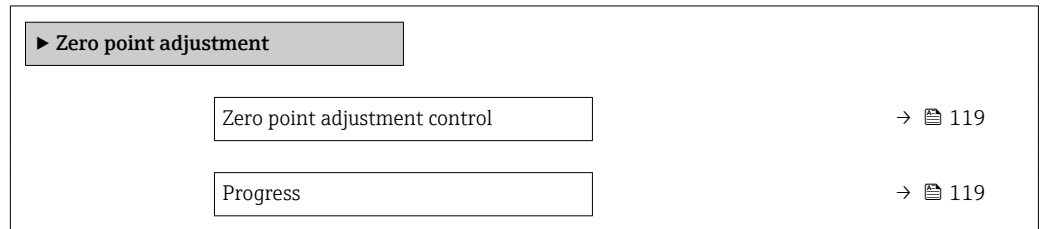

**Parameter overview with brief description**

Parameter	Description	Selection / User interface	Factory setting
Zero point adjustment control	Start zero point adjustment.	<ul style="list-style-type: none"> <li>▪ Cancel</li> <li>▪ Start</li> </ul>	Cancel
Progress	Shows the progress of the process.	0 to 100 %	-

**10.4.4 Configuring the totalizer**

In the "Totalizer 1 to n" submenu the individual totalizer can be configured.

**Navigation**



"Setup" menu → Advanced setup → Totalizer 1 to n

▶ <b>Totalizer 1 to n</b>	
Assign process variable	→ 120
Unit totalizer 1 to n	→ 120
Totalizer operation mode	→ 121
Failure mode	→ 121

**Parameter overview with brief description**

Parameter	Prerequisite	Description	Selection	Factory setting
Assign process variable	-	Select process variable for totalizer.	<ul style="list-style-type: none"> <li>■ Off</li> <li>■ Mass flow</li> <li>■ Volume flow</li> <li>■ Corrected volume flow*</li> <li>■ Target mass flow*</li> <li>■ Carrier mass flow*</li> <li>■ Target volume flow*</li> <li>■ Carrier volume flow*</li> <li>■ Target corrected volume flow*</li> <li>■ Carrier corrected volume flow*</li> <li>■ GSV flow*</li> <li>■ GSV flow alternative*</li> <li>■ NSV flow*</li> <li>■ NSV flow alternative*</li> <li>■ S&amp;W volume flow*</li> <li>■ Oil mass flow*</li> <li>■ Water mass flow*</li> <li>■ Oil volume flow*</li> <li>■ Water volume flow*</li> <li>■ Oil corrected volume flow*</li> <li>■ Water corrected volume flow*</li> </ul>	Mass flow
Unit totalizer 1 to n	A process variable is selected in the <b>Assign process variable</b> parameter (→ 120) of the <b>Totalizer 1 to n</b> submenu.	Select process variable totalizer unit.	Unit choose list	Country-specific: <ul style="list-style-type: none"> <li>■ kg</li> <li>■ lb</li> </ul>



Parameter	Prerequisite	Description	Selection	Factory setting
Totalizer operation mode	A process variable is selected in the <b>Assign process variable</b> parameter (→  120) of the <b>Totalizer 1 to n</b> submenu.	Select totalizer calculation mode.	<ul style="list-style-type: none"> <li>▪ Net flow total</li> <li>▪ Forward flow total</li> <li>▪ Reverse flow total</li> </ul>	Net flow total
Failure mode	A process variable is selected in the <b>Assign process variable</b> parameter (→  120) of the <b>Totalizer 1 to n</b> submenu.	Define totalizer behavior in alarm condition.	<ul style="list-style-type: none"> <li>▪ Stop</li> <li>▪ Actual value</li> <li>▪ Last valid value</li> </ul>	Stop

\* Visibility depends on order options or device settings



## 10.4.5 Carrying out additional display configurations

In the **Display** submenu you can set all the parameters associated with the configuration of the local display.

### Navigation

"Setup" menu → Advanced setup → Display



► Display	
Format display	→ 124
Value 1 display	→ 125
0% bargraph value 1	→ 126
100% bargraph value 1	→ 126
Decimal places 1	→ 126
Value 2 display	→ 126
Decimal places 2	→ 126
Value 3 display	→ 126
0% bargraph value 3	→ 126
100% bargraph value 3	→ 126
Decimal places 3	→ 126
Value 4 display	→ 126
Decimal places 4	→ 126
Display language	→ 127
Display interval	→ 127
Display damping	→ 127
Header	→ 127
Header text	→ 127

Separator	→  127
Backlight	→  127

**Parameter overview with brief description**

Parameter	Prerequisite	Description	Selection / User entry	Factory setting
Format display	A local display is provided.	Select how measured values are shown on the display.	<ul style="list-style-type: none"><li>■ 1 value, max. size</li><li>■ 1 bargraph + 1 value</li><li>■ 2 values</li><li>■ 1 value large + 2 values</li><li>■ 4 values</li></ul>	1 value, max. size

Parameter	Prerequisite	Description	Selection / User entry	Factory setting
Value 1 display	A local display is provided.	Select the measured value that is shown on the local display.	<ul style="list-style-type: none"> <li>■ Mass flow</li> <li>■ Volume flow</li> <li>■ Corrected volume flow*</li> <li>■ Target mass flow*</li> <li>■ Carrier mass flow*</li> <li>■ Target volume flow*</li> <li>■ Carrier volume flow*</li> <li>■ Target corrected volume flow*</li> <li>■ Carrier corrected volume flow*</li> <li>■ Density</li> <li>■ Reference density*</li> <li>■ Reference density alternative*</li> <li>■ GSV flow*</li> <li>■ GSV flow alternative*</li> <li>■ NSV flow*</li> <li>■ NSV flow alternative*</li> <li>■ S&amp;W volume flow*</li> <li>■ Water cut*</li> <li>■ Oil density*</li> <li>■ Water density*</li> <li>■ Oil mass flow*</li> <li>■ Water mass flow*</li> <li>■ Oil volume flow*</li> <li>■ Water volume flow*</li> <li>■ Oil corrected volume flow*</li> <li>■ Water corrected volume flow*</li> <li>■ Weighted density average*</li> <li>■ Weighted temperature average*</li> <li>■ Concentration*</li> <li>■ Temperature</li> <li>■ Carrier pipe temperature*</li> <li>■ Electronic temperature</li> <li>■ Oscillation frequency 0</li> <li>■ Oscillation amplitude 0*</li> <li>■ Frequency fluctuation 0*</li> <li>■ Oscillation damping 0*</li> <li>■ Oscillation damping fluctuation 0*</li> <li>■ Signal asymmetry*</li> <li>■ Exciter current 0*</li> <li>■ Totalizer 1</li> <li>■ Totalizer 2</li> </ul>	Mass flow

Parameter	Prerequisite	Description	Selection / User entry	Factory setting
			<ul style="list-style-type: none"> <li>■ Totalizer 3</li> <li>■ Current output 1 *</li> <li>■ Current output 2 *</li> <li>■ Pressure</li> <li>■ Application specific output 1 *</li> <li>■ Index inhomogeneous medium</li> <li>■ Application specific output 0 *</li> <li>■ Index suspended bubbles *</li> </ul>	
0% bargraph value 1	A local display is provided.	Enter 0% value for bar graph display.	Signed floating-point number	Country-specific: <ul style="list-style-type: none"> <li>■ 0 kg/h</li> <li>■ 0 lb/min</li> </ul>
100% bargraph value 1	A local display is provided.	Enter 100% value for bar graph display.	Signed floating-point number	Depends on country and nominal diameter
Decimal places 1	A measured value is specified in the <b>Value 1 display</b> parameter.	Select the number of decimal places for the display value.	<ul style="list-style-type: none"> <li>■ x</li> <li>■ x.x</li> <li>■ x.xx</li> <li>■ x.xxx</li> <li>■ x.xxxx</li> </ul>	x.xx
Value 2 display	A local display is provided.	Select the measured value that is shown on the local display.	For the picklist, see the <b>Value 2 display</b> parameter (→  113)	None
Decimal places 2	A measured value is specified in the <b>Value 2 display</b> parameter.	Select the number of decimal places for the display value.	<ul style="list-style-type: none"> <li>■ x</li> <li>■ x.x</li> <li>■ x.xx</li> <li>■ x.xxx</li> <li>■ x.xxxx</li> </ul>	x.xx
Value 3 display	A local display is provided.	Select the measured value that is shown on the local display.	For the picklist, see the <b>Value 2 display</b> parameter (→  113)	None
0% bargraph value 3	A selection was made in the <b>Value 3 display</b> parameter.	Enter 0% value for bar graph display.	Signed floating-point number	Country-specific: <ul style="list-style-type: none"> <li>■ 0 kg/h</li> <li>■ 0 lb/min</li> </ul>
100% bargraph value 3	A selection was made in the <b>Value 3 display</b> parameter.	Enter 100% value for bar graph display.	Signed floating-point number	0
Decimal places 3	A measured value is specified in the <b>Value 3 display</b> parameter.	Select the number of decimal places for the display value.	<ul style="list-style-type: none"> <li>■ x</li> <li>■ x.x</li> <li>■ x.xx</li> <li>■ x.xxx</li> <li>■ x.xxxx</li> </ul>	x.xx
Value 4 display	A local display is provided.	Select the measured value that is shown on the local display.	For the picklist, see the <b>Value 2 display</b> parameter (→  113)	None
Decimal places 4	A measured value is specified in the <b>Value 4 display</b> parameter.	Select the number of decimal places for the display value.	<ul style="list-style-type: none"> <li>■ x</li> <li>■ x.x</li> <li>■ x.xx</li> <li>■ x.xxx</li> <li>■ x.xxxx</li> </ul>	x.xx

Parameter	Prerequisite	Description	Selection / User entry	Factory setting
Display language	A local display is provided.	Set display language.	<ul style="list-style-type: none"> <li>▪ English</li> <li>▪ Deutsch</li> <li>▪ Français</li> <li>▪ Español</li> <li>▪ Italiano</li> <li>▪ Nederlands</li> <li>▪ Portuguesa</li> <li>▪ Polski</li> <li>▪ русский язык (Russian)</li> <li>▪ Svenska</li> <li>▪ Türkçe</li> <li>▪ 中文 (Chinese)</li> <li>▪ 日本語 (Japanese)</li> <li>▪ 한국어 (Korean)</li> <li>▪ العربية (Arabic) *</li> <li>▪ Bahasa Indonesia</li> <li>▪ ภาษาไทย (Thai) *</li> <li>▪ tiếng Việt (Vietnamese)</li> <li>▪ čeština (Czech)</li> </ul>	English (alternatively, the ordered language is preset in the device)
Display interval	A local display is provided.	Set time measured values are shown on display if display alternates between values.	1 to 10 s	5 s
Display damping	A local display is provided.	Set display reaction time to fluctuations in the measured value.	0.0 to 999.9 s	0.0 s
Header	A local display is provided.	Select header contents on local display.	<ul style="list-style-type: none"> <li>▪ Device tag</li> <li>▪ Free text</li> </ul>	Device tag
Header text	In the <b>Header</b> parameter, the <b>Free text</b> option is selected.	Enter display header text.	Max. 12 characters such as letters, numbers or special characters (e.g. @, %, /)	-----
Separator	A local display is provided.	Select decimal separator for displaying numerical values.	<ul style="list-style-type: none"> <li>▪ . (point)</li> <li>▪ , (comma)</li> </ul>	. (point)
Backlight	One of the following conditions is met: <ul style="list-style-type: none"> <li>▪ Order code for "Display; operation", option <b>F</b> "4-line, illum.; touch control"</li> <li>▪ Order code for "Display; operation", option <b>G</b> "4-line, illum.; touch control +WLAN"</li> <li>▪ Order code for "Display; operation", option <b>O</b> "Separate 4-line display, illum.; 10m/30ft cable; touch control"</li> </ul>	Switch the local display backlight on and off.	<ul style="list-style-type: none"> <li>▪ Disable</li> <li>▪ Enable</li> </ul>	Enable

\* Visibility depends on order options or device settings

### 10.4.6 WLAN configuration

The **WLAN Settings** submenu guides the user systematically through all the parameters that have to be set for the WLAN configuration.

**Navigation**

"Setup" menu → Advanced setup → WLAN Settings

▶ **WLAN settings**

WLAN IP address	→ ⓘ 128
Security type	→ ⓘ 128
WLAN passphrase	→ ⓘ 128
Assign SSID name	→ ⓘ 128
SSID name	→ ⓘ 129
Apply changes	→ ⓘ 129

**Parameter overview with brief description**

Parameter	Prerequisite	Description	User entry / Selection	Factory setting
WLAN IP address	–	Enter IP address of the WLAN interface of the device.	4 octet: 0 to 255 (in the particular octet)	192.168.1.212
Network security	–	Select the security type of the WLAN network.	<ul style="list-style-type: none"> <li>■ Unsecured</li> <li>■ WPA2-PSK</li> <li>■ EAP-PEAP with MSCHAPv2 *</li> <li>■ EAP-PEAP MSCHAPv2 no server authentic. *</li> <li>■ EAP-TLS *</li> </ul>	WPA2-PSK
WLAN passphrase	The <b>WPA2-PSK</b> option is selected in the <b>Security type</b> parameter.	Enter the network key (8 to 32 characters). The network key supplied with the device should be changed during commissioning for security reasons.	8 to 32-digit character string comprising numbers, letters and special characters (without spaces)	Serial number of the measuring device (e.g. L100A802000)
Assign SSID name	–	Select which name will be used for SSID: device tag or user-defined name.	<ul style="list-style-type: none"> <li>■ Device tag</li> <li>■ User-defined</li> </ul>	User-defined



Parameter	Prerequisite	Description	User entry / Selection	Factory setting
SSID name	<ul style="list-style-type: none"> <li>The <b>User-defined</b> option is selected in the <b>Assign SSID name</b> parameter.</li> <li>The <b>WLAN access point</b> option is selected in the <b>WLAN mode</b> parameter.</li> </ul>	Enter the user-defined SSID name (max. 32 characters).  The user-defined SSID name may only be assigned once. If the SSID name is assigned more than once, the devices can interfere with one another.	Max. 32-digit character string comprising numbers, letters and special characters	EH_device designation_last 7 digits of the serial number (e.g. EH_Promass_300_A802000)
Apply changes	-	Use changed WLAN settings.	<ul style="list-style-type: none"> <li>Cancel</li> <li>Ok</li> </ul>	Cancel

\* Visibility depends on order options or device settings

### 10.4.7 Configuration management

After commissioning, you can save the current device configuration or restore the previous device configuration.

You can do so using the **Configuration management** parameter and the related options found in the **Configuration backup** submenu.

#### Navigation

"Setup" menu → Advanced setup → Configuration backup

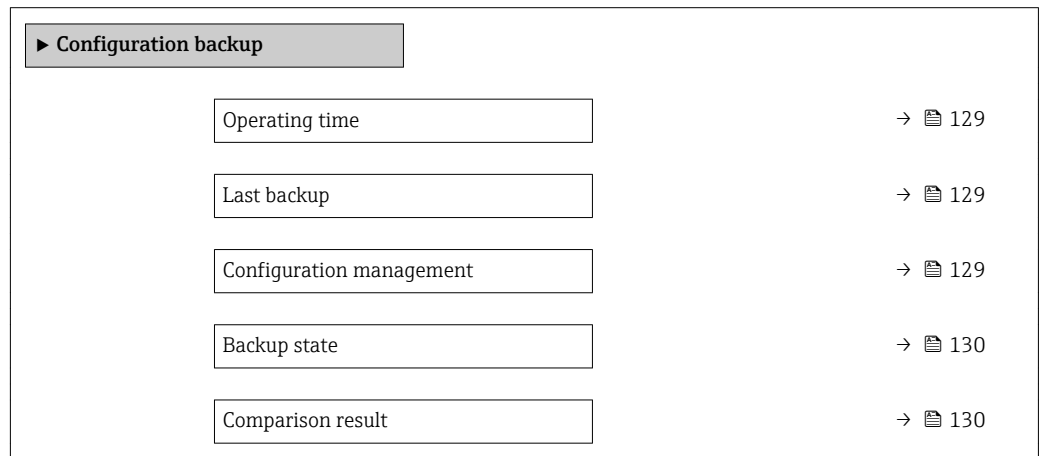

#### Parameter overview with brief description

Parameter	Description	User interface / Selection	Factory setting
Operating time	Indicates how long the device has been in operation.	Days (d), hours (h), minutes (m) and seconds (s)	-
Last backup	Shows when the last data backup was saved to HistoROM backup.	Days (d), hours (h), minutes (m) and seconds (s)	-
Configuration management	Select action for managing the device data in the HistoROM backup.	<ul style="list-style-type: none"> <li>Cancel</li> <li>Execute backup</li> <li>Restore *</li> <li>Compare *</li> <li>Clear backup data</li> </ul>	Cancel

Parameter	Description	User interface / Selection	Factory setting
Backup state	Shows the current status of data saving or restoring.	<ul style="list-style-type: none"> <li>■ None</li> <li>■ Backup in progress</li> <li>■ Restoring in progress</li> <li>■ Delete in progress</li> <li>■ Compare in progress</li> <li>■ Restoring failed</li> <li>■ Backup failed</li> </ul>	None
Comparison result	Comparison of current device data with HistoROM backup.	<ul style="list-style-type: none"> <li>■ Settings identical</li> <li>■ Settings not identical</li> <li>■ No backup available</li> <li>■ Backup settings corrupt</li> <li>■ Check not done</li> <li>■ Dataset incompatible</li> </ul>	Check not done

\* Visibility depends on order options or device settings

### Function scope of the "Configuration management" parameter

Options	Description
Cancel	No action is executed and the user exits the parameter.
Execute backup	A backup copy of the current device configuration is saved from the HistoROM backup to the memory of the device. The backup copy includes the transmitter data of the device.
Restore	The last backup copy of the device configuration is restored from the device memory to the device's HistoROM backup. The backup copy includes the transmitter data of the device.
Compare	The device configuration saved in the device memory is compared with the current device configuration of the HistoROM backup.
Clear backup data	The backup copy of the device configuration is deleted from the memory of the device.



#### *HistoROM backup*

A HistoROM is a "non-volatile" device memory in the form of an EEPROM.



While this action is in progress, the configuration cannot be edited via the local display and a message on the processing status appears on the display.

## 10.4.8 Using parameters for device administration

The **Administration** submenu systematically guides the user through all the parameters that can be used for device administration purposes.

### Navigation

"Setup" menu → Advanced setup → Administration

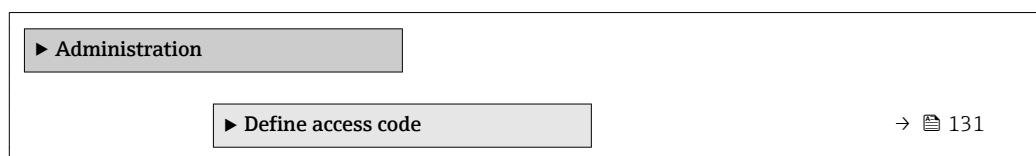

<b>▶ Reset access code</b>	→ 📄 131
Device reset	→ 📄 132

### Using the parameter to define the access code

#### Navigation

"Setup" menu → Advanced setup → Administration → Define access code

<b>▶ Define access code</b>	
Define access code	→ 📄 131
Confirm access code	→ 📄 131

### Parameter overview with brief description

Parameter	Description	User entry
Define access code	Restrict write-access to parameters to protect the configuration of the device against unintentional changes.	Max. 16-digit character string comprising numbers, letters and special characters
Confirm access code	Confirm the entered access code.	Max. 16-digit character string comprising numbers, letters and special characters

### Using the parameter to reset the access code

#### Navigation

"Setup" menu → Advanced setup → Administration → Reset access code

<b>▶ Reset access code</b>	
Operating time	→ 📄 132
Reset access code	→ 📄 132

### Parameter overview with brief description

Parameter	Description	User interface / User entry	Factory setting
Operating time	Indicates how long the device has been in operation.	Days (d), hours (h), minutes (m) and seconds (s)	-
Reset access code	Reset access code to factory settings.  For a reset code, contact your Endress+Hauser service organization. The reset code can only be entered via: <ul style="list-style-type: none"> <li>▪ Web browser</li> <li>▪ DeviceCare, FieldCare (via service interface CDI-RJ45)</li> <li>▪ Fieldbus</li> </ul>	Character string comprising numbers, letters and special characters	0x00

### Using the parameter to reset the device

#### Navigation

"Setup" menu → Advanced setup → Administration

### Parameter overview with brief description

Parameter	Description	Selection	Factory setting
Device reset	Reset the device configuration - either entirely or in part - to a defined state.	<ul style="list-style-type: none"> <li>▪ Cancel</li> <li>▪ To delivery settings</li> <li>▪ Restart device</li> <li>▪ Restore S-DAT backup *</li> </ul>	Cancel

\* Visibility depends on order options or device settings

## 10.5 Simulation

The **Simulation** submenu enables you to simulate, without a real flow situation, various process variables in the process and the device alarm mode and to verify downstream signal chains (switching valves or closed-control loops).

#### Navigation



"Diagnostics" menu → Simulation

► Simulation	
Assign simulation process variable	→ ⓘ 134
Process variable value	→ ⓘ 134
Current input 1 to n simulation	→ ⓘ 134
Value current input 1 to n	→ ⓘ 134
Status input simulation 1 to n	→ ⓘ 134

Input signal level 1 to n	→ 134
Current output 1 to n simulation	→ 134
Value current output 1 to n	→ 135
Frequency output simulation 1 to n	→ 135
Frequency value 1 to n	→ 135
Pulse output simulation 1 to n	→ 135
Pulse value 1 to n	→ 135
Switch output simulation 1 to n	→ 135
Switch status 1 to n	→ 135
Relay output 1 to n simulation	→ 135
Switch status 1 to n	→ 135
Pulse output simulation	→ 135
Pulse value	→ 135
Device alarm simulation	→ 135
Diagnostic event category	→ 135
Diagnostic event simulation	→ 136

## Parameter overview with brief description

Parameter	Prerequisite	Description	Selection / User entry / User interface	Factory setting
Assign simulation process variable	–	Select a process variable for the simulation process that is activated.	<ul style="list-style-type: none"> <li>■ Off</li> <li>■ Mass flow</li> <li>■ Volume flow</li> <li>■ Corrected volume flow<sup>*</sup></li> <li>■ Target mass flow<sup>*</sup></li> <li>■ Carrier mass flow<sup>*</sup></li> <li>■ Target volume flow<sup>*</sup></li> <li>■ Carrier volume flow<sup>*</sup></li> <li>■ Target corrected volume flow<sup>*</sup></li> <li>■ Carrier corrected volume flow<sup>*</sup></li> <li>■ Density</li> <li>■ Reference density<sup>*</sup></li> <li>■ Reference density alternative<sup>*</sup></li> <li>■ GSV flow<sup>*</sup></li> <li>■ GSV flow alternative<sup>*</sup></li> <li>■ NSV flow<sup>*</sup></li> <li>■ NSV flow alternative<sup>*</sup></li> <li>■ S&amp;W volume flow<sup>*</sup></li> <li>■ Water cut<sup>*</sup></li> <li>■ Oil density<sup>*</sup></li> <li>■ Water density<sup>*</sup></li> <li>■ Oil mass flow<sup>*</sup></li> <li>■ Water mass flow<sup>*</sup></li> <li>■ Oil volume flow<sup>*</sup></li> <li>■ Water volume flow<sup>*</sup></li> <li>■ Oil corrected volume flow<sup>*</sup></li> <li>■ Water corrected volume flow<sup>*</sup></li> <li>■ Temperature<sup>*</sup></li> <li>■ Concentration<sup>*</sup></li> </ul>	Off
Process variable value	A process variable is selected in the <b>Assign simulation process variable</b> parameter (→  134).	Enter the simulation value for the selected process variable.	Depends on the process variable selected	0
Status input simulation 1 to n	–	Switch simulation of the status input on and off.	<ul style="list-style-type: none"> <li>■ Off</li> <li>■ On</li> </ul>	Off
Input signal level 1 to n	In the <b>Status input simulation</b> parameter, the <b>On</b> option is selected.	Select the signal level for the simulation of the status input.	<ul style="list-style-type: none"> <li>■ High</li> <li>■ Low</li> </ul>	High
Current input 1 to n simulation	–	Switch simulation of the current input on and off.	<ul style="list-style-type: none"> <li>■ Off</li> <li>■ On</li> </ul>	Off
Value current input 1 to n	In the <b>Current input 1 to n simulation</b> parameter, the <b>On</b> option is selected.	Enter the current value for simulation.	0 to 22.5 mA	0 mA
Current output 1 to n simulation	–	Switch the simulation of the current output on and off.	<ul style="list-style-type: none"> <li>■ Off</li> <li>■ On</li> </ul>	Off



Parameter	Prerequisite	Description	Selection / User entry / User interface	Factory setting
Value current output 1 to n	In the <b>Current output 1 to n simulation</b> parameter, the <b>On</b> option is selected.	Enter the current value for simulation.	3.59 to 22.5 mA	3.59 mA
Frequency output simulation 1 to n	In the <b>Operating mode</b> parameter, the <b>Frequency</b> option is selected.	Switch the simulation of the frequency output on and off.	<ul style="list-style-type: none"> <li>▪ Off</li> <li>▪ On</li> </ul>	Off
Frequency value 1 to n	In the <b>Frequency output simulation 1 to n</b> parameter, the <b>On</b> option is selected.	Enter the frequency value for the simulation.	0.0 to 12 500.0 Hz	0.0 Hz
Pulse output simulation 1 to n	In the <b>Operating mode</b> parameter, the <b>Pulse</b> option is selected.	Set and switch off the pulse output simulation.  For <b>Fixed value</b> option: <b>Pulse width</b> parameter (→ 97) defines the pulse width of the pulses output.	<ul style="list-style-type: none"> <li>▪ Off</li> <li>▪ Fixed value</li> <li>▪ Down-counting value</li> </ul>	Off
Pulse value 1 to n	In the <b>Pulse output simulation 1 to n</b> parameter, the <b>Down-counting value</b> option is selected.	Enter the number of pulses for simulation.	0 to 65 535	0
Switch output simulation 1 to n	In the <b>Operating mode</b> parameter, the <b>Switch</b> option is selected.	Switch the simulation of the switch output on and off.	<ul style="list-style-type: none"> <li>▪ Off</li> <li>▪ On</li> </ul>	Off
Switch status 1 to n	–	Select the status of the status output for the simulation.	<ul style="list-style-type: none"> <li>▪ Open</li> <li>▪ Closed</li> </ul>	Open
Relay output 1 to n simulation	–	Switch simulation of the relay output on and off.	<ul style="list-style-type: none"> <li>▪ Off</li> <li>▪ On</li> </ul>	Off
Switch status 1 to n	The <b>On</b> option is selected in the <b>Switch output simulation 1 to n</b> parameter parameter.	Select status of the relay output for the simulation.	<ul style="list-style-type: none"> <li>▪ Open</li> <li>▪ Closed</li> </ul>	Open
Pulse output simulation	–	Set and switch off the pulse output simulation.  For <b>Fixed value</b> option: <b>Pulse width</b> parameter defines the pulse width of the pulses output.	<ul style="list-style-type: none"> <li>▪ Off</li> <li>▪ Fixed value</li> <li>▪ Down-counting value</li> </ul>	Off
Pulse value	In the <b>Pulse output simulation</b> parameter, the <b>Down-counting value</b> option is selected.	Set and switch off the pulse output simulation.	0 to 65 535	0
Device alarm simulation	–	Switch the device alarm on and off.	<ul style="list-style-type: none"> <li>▪ Off</li> <li>▪ On</li> </ul>	Off
Diagnostic event category	–	Select a diagnostic event category.	<ul style="list-style-type: none"> <li>▪ Sensor</li> <li>▪ Electronics</li> <li>▪ Configuration</li> <li>▪ Process</li> </ul>	Process

Parameter	Prerequisite	Description	Selection / User entry / User interface	Factory setting
Diagnostic event simulation	–	Select a diagnostic event to simulate this event.	<ul style="list-style-type: none"> <li>▪ Off</li> <li>▪ Diagnostic event picklist (depends on the category selected)</li> </ul>	Off
Logging interval	–	Define the logging interval tlog for data logging. This value defines the time interval between the individual data points in the memory.	1.0 to 3 600.0 s	–

\* Visibility depends on order options or device settings

## 10.6 Protecting settings from unauthorized access

The following write protection options exist in order to protect the configuration of the measuring device from unintentional modification:



- Protect access to parameters via access code →  136
- Protect access to local operation via key locking →  62
- Protect access to measuring device via write protection switch →  137

### 10.6.1 Write protection via access code



The effects of the user-specific access code are as follows:

- Via local operation, the parameters for the measuring device configuration are write-protected and their values can no longer be changed.
- Device access is protected via the Web browser, as are the parameters for the measuring device configuration.
- Device access is protected via FieldCare or DeviceCare (via CDI-RJ45 service interface), as are the parameters for the measuring device configuration.

#### Defining the access code via local display

1. Navigate to the **Define access code** parameter (→  131).
2. Define a max. 16-digit character string comprising numbers, letters and special characters as the access code.
3. Enter the access code again in the **Confirm access code** parameter (→  131) to confirm the code.
  - ↳ The -symbol appears in front of all write-protected parameters.

The device automatically locks the write-protected parameters again if a key is not pressed for 10 minutes in the navigation and editing view. The device locks the write-protected parameters automatically after 60 s if the user skips back to the operational display mode from the navigation and editing view.

-  ▪ If parameter write protection is activated via an access code, it can also only be deactivated via this access code →  62.
- The user role with which the user is currently logged on via the local display →  61 is indicated by the **Access status** parameter. Navigation path: Operation → Access status



### Parameters which can always be modified via the local display

Certain parameters that do not affect the measurement are excepted from parameter write protection via the local display. Despite the user-specific access code, they can always be modified, even if the other parameters are locked.

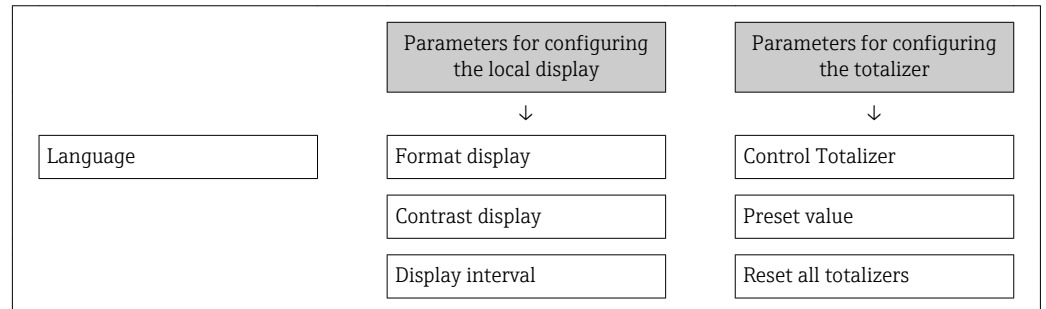

### Defining the access code via the Web browser

1. Navigate to the **Define access code** parameter (→ ⓘ 131).
2. Define a max. 16-digit numeric code as an access code.
3. Enter the access code again in the **Confirm access code** parameter (→ ⓘ 131) to confirm the code.
  - ↳ The Web browser switches to the login page.

**i** If no action is performed for 10 minutes, the Web browser automatically returns to the login page.

- i**
  - If parameter write protection is activated via an access code, it can also only be deactivated via this access code → ⓘ 62.
  - The user role with which the user is currently logged on via Web browser is indicated by the **Access status** parameter. Navigation path: Operation → Access status

### Resetting the access code

If you misplace the user-specific access code, it is possible to reset the code to the factory setting. A reset code must be entered for this purpose. The user-specific access code can then be defined again afterwards.

#### Via Web browser, FieldCare, DeviceCare (via CDI-RJ45 service interface), fieldbus

**i** For a reset code, contact your Endress+Hauser service organization.

1. Navigate to the **Reset access code** parameter (→ ⓘ 132).
2. Enter the reset code.
  - ↳ The access code has been reset to the factory setting **0000**. It can be redefined → ⓘ 136.

### 10.6.2 Write protection via write protection switch

Unlike parameter write protection via a user-specific access code, this allows write access to the entire operating menu - except for the **"Contrast display" parameter** - to be locked.

The parameter values are now read only and cannot be edited any more (exception "**Contrast display**" parameter):

- Via local display
- Via MODBUS RS485 protocol

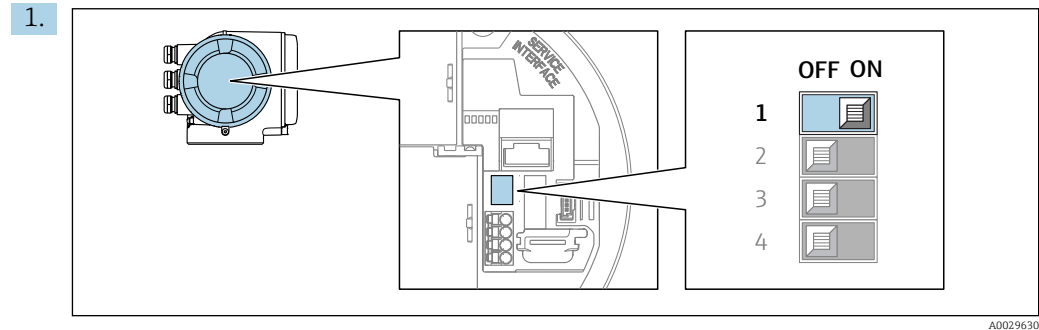

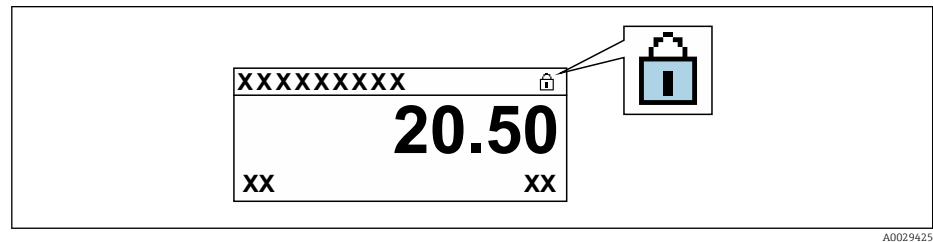

Setting the write protection (WP) switch on the main electronics module to the **ON** position enables hardware write protection.

- ↳ In the **Locking status** parameter the **Hardware locked** option is displayed →  139. In addition, on the local display the -symbol appears in front of the parameters in the header of the operational display and in the navigation view.



2. Setting the write protection (WP) switch on the main electronics module to the **OFF** position (factory setting) disables hardware write protection.

- ↳ No option is displayed in the **Locking status** parameter →  139. On the local display, the -symbol disappears from in front of the parameters in the header of the operational display and in the navigation view.





## 11 Operation

### 11.1 Reading the device locking status

Device active write protection: **Locking status** parameter



Operation → Locking status

*Function scope of the "Locking status" parameter*

Options	Description
None	The access status displayed in the <b>Access status</b> parameter applies →  61. Only appears on local display.
Hardware locked	The DIP switch for hardware locking is activated on the PCB board. This locks write access to the parameters (e.g. via local display or operating tool) →  137.
Custody transfer active	The DIP switch for custody transfer mode is activated on the PCB board. This locks write access to all the parameters (e.g. via local display or operating tool).  For detailed information on custody transfer mode, see the Special Documentation for the device
CT active - defined parameters	The DIP switch for custody transfer mode is activated on the PCB board. This locks write access to the defined parameters (e.g. via local display or operating tool).  For detailed information on custody transfer mode, see the Special Documentation for the device
Temporarily locked	Write access to the parameters is temporarily locked on account of internal processes running in the device (e.g. data upload/download, reset etc.). Once the internal processing has been completed, the parameters can be changed once again.



### 11.2 Adjusting the operating language

 Detailed information:

- To configure the operating language →  81
- For information on the operating languages supported by the measuring device →  210

### 11.3 Configuring the display

Detailed information:

- On the basic settings for the local display →  109
- On the advanced settings for the local display →  122

### 11.4 Reading measured values

With the **Measured values** submenu, it is possible to read all the measured values.

**Navigation**

"Diagnostics" menu → Measured values

► Measured values	
► Measured variables	→ 140
► Input values	→ 142
► Output values	→ 144
► Totalizer	→ 142

**11.4.1 "Measured variables" submenu**









The **Measured variables** submenu contains all the parameters needed to display the current measured values for each process variable.





**Navigation**

"Diagnostics" menu → Measured values → Measured variables

► Measured variables	
Mass flow	→ 141
Volume flow	→ 141
Corrected volume flow	→ 141
Density	→ 141
Reference density	→ 141
Temperature	→ 141
Pressure value	→ 141
Concentration	→ 141
Target mass flow	→ 142
Carrier mass flow	→ 142

## Parameter overview with brief description

Parameter	Prerequisite	Description	User interface
Mass flow	–	Displays the mass flow that is currently measured. <i>Dependency</i> The unit is taken from the <b>Mass flow unit</b> parameter (→  84).	Signed floating-point number
Volume flow	–	Displays the volume flow currently calculated. <i>Dependency</i> The unit is taken from the <b>Volume flow unit</b> parameter (→  84).	Signed floating-point number
Corrected volume flow	–	Displays the corrected volume flow that is currently calculated. <i>Dependency</i> The unit is taken from the <b>Corrected volume flow unit</b> parameter (→  85).	Signed floating-point number
Density	–	Shows the density currently measured. <i>Dependency</i> The unit is taken from the <b>Density unit</b> parameter (→  85).	Signed floating-point number
Reference density	–	Displays the reference density that is currently calculated. <i>Dependency</i> The unit is taken from the <b>Reference density unit</b> parameter (→  85).	Signed floating-point number
Temperature	–	Shows the medium temperature currently measured. <i>Dependency</i> The unit is taken from the <b>Temperature unit</b> parameter (→  85).	Signed floating-point number
Pressure value	–	Displays either a fixed or external pressure value. <i>Dependency</i> The unit is taken from the <b>Pressure unit</b> parameter (→  85).	Signed floating-point number
Concentration	For the following order code: Order code for "Application package", option <b>ED</b> "Concentration"  The software options currently enabled are displayed in the <b>Software option overview</b> parameter.	Displays the concentration that is currently calculated. <i>Dependency</i> The unit is taken from the <b>Concentration unit</b> parameter.	Signed floating-point number



Parameter	Prerequisite	Description	User interface
Target mass flow	With the following conditions: Order code for "Application package", option <b>ED</b> "Concentration"  The software options currently enabled are displayed in the <b>Software option overview</b> parameter.	Displays the mass flow that is currently measured for the target medium. <i>Dependency</i> The unit is taken from the <b>Mass flow unit</b> parameter (→  84).	Signed floating-point number
Carrier mass flow	With the following conditions: Order code for "Application package", option <b>ED</b> "Concentration"  The software options currently enabled are displayed in the <b>Software option overview</b> parameter.	Displays the mass flow that is currently measured for the carrier medium. <i>Dependency</i> The unit is taken from the <b>Mass flow unit</b> parameter (→  84).	Signed floating-point number

### 11.4.2 "Totalizer" submenu



The **Totalizer** submenu contains all the parameters needed to display the current measured values for every totalizer.

#### Navigation

"Diagnostics" menu → Measured values → Totalizer

<p>► <b>Totalizer</b></p> <p>Totalizer value 1 to n →  142</p> <p>Totalizer overflow 1 to n →  142</p>
--

#### Parameter overview with brief description

Parameter	Prerequisite	Description	User interface
Totalizer value 1 to n	A process variable is selected in the <b>Assign process variable</b> parameter (→  120) of the <b>Totalizer 1 to n</b> submenu.	Displays the current totalizer counter value.	Signed floating-point number
Totalizer overflow 1 to n	A process variable is selected in the <b>Assign process variable</b> parameter (→  120) of the <b>Totalizer 1 to n</b> submenu.	Displays the current totalizer overflow.	Integer with sign

### 11.4.3 "Input values" submenu

The **Input values** submenu guides you systematically to the individual input values.

**Navigation**

"Diagnostics" menu → Measured values → Input values

▶ Input values

▶ Current input 1 to n

→ 📄 143

▶ Status input 1 to n

→ 📄 143

**Input values of current input**

The **Current input 1 to n** submenu contains all the parameters needed to display the current measured values for every current input.

**Navigation**

"Diagnostics" menu → Measured values → Input values → Current input 1 to n

▶ Current input 1 to n

Measured values 1 to n

→ 📄 143

Measured current 1 to n

→ 📄 143

**Parameter overview with brief description**

Parameter	Description	User interface
Measured values 1 to n	Displays the current input value.	Signed floating-point number
Measured current 1 to n	Displays the current value of the current input.	0 to 22.5 mA

**Input values of status input**

The **Status input 1 to n** submenu contains all the parameters needed to display the current measured values for every status input.

**Navigation**

"Diagnostics" menu → Measured values → Input values → Status input 1 to n

▶ Status input 1 to n

Value status input

→ 📄 144

**Parameter overview with brief description**

Parameter	Description	User interface
Value status input	Shows the current input signal level.	<ul style="list-style-type: none"> <li>■ High</li> <li>■ Low</li> </ul>

**11.4.4 Output values**

The **Output values** submenu contains all the parameters needed to display the current measured values for every output.

**Navigation**

"Diagnostics" menu → Measured values → Output values

▶ **Output values**

▶ **Current output 1 to n** →  144

▶ **Pulse/frequency/switch output 1 to n** →  145

▶ **Relay output 1 to n** →  145

▶ **Double pulse output** →  146

**Output values of current output**

The **Value current output** submenu contains all the parameters needed to display the current measured values for every current output.

**Navigation**

"Diagnostics" menu → Measured values → Output values → Value current output 1 to n

▶ **Current output 1 to n**

Output current 1 to n →  144

Measured current 1 to n →  144

**Parameter overview with brief description**

Parameter	Description	User interface
Output current 1	Displays the current value currently calculated for the current output.	3.59 to 22.5 mA
Measured current	Displays the current value currently measured for the current output.	0 to 30 mA



### Output values for pulse/frequency/switch output

The **Pulse/frequency/switch output 1 to n** submenu contains all the parameters needed to display the current measured values for every pulse/frequency/switch output.

#### Navigation

"Diagnostics" menu → Measured values → Output values → Pulse/frequency/switch output 1 to n

▶ Pulse/frequency/switch output 1 to n

Output frequency 1 to n	→  145
Pulse output 1 to n	→  145
Switch status 1 to n	→  145

### Parameter overview with brief description

Parameter	Prerequisite	Description	User interface
Output frequency 1 to n	In the <b>Operating mode</b> parameter, the <b>Frequency</b> option is selected.	Displays the value currently measured for the frequency output.	0.0 to 12 500.0 Hz
Pulse output 1 to n	The <b>Pulse</b> option is selected in the <b>Operating mode</b> parameter parameter.	Displays the pulse frequency currently output.	Positive floating-point number
Switch status 1 to n	The <b>Switch</b> option is selected in the <b>Operating mode</b> parameter.	Displays the current switch output status.	<ul style="list-style-type: none"> <li>▪ Open</li> <li>▪ Closed</li> </ul>

### Output values for relay output

The **Relay output 1 to n** submenu contains all the parameters needed to display the current measured values for every relay output.

#### Navigation

"Diagnostics" menu → Measured values → Output values → Relay output 1 to n

▶ Relay output 1 to n

Switch status	→  146
Switch cycles	→  146
Max. switch cycles number	→  146

### Parameter overview with brief description

Parameter	Description	User interface
Switch status	Shows the current relay switch status.	<ul style="list-style-type: none"> <li>▪ Open</li> <li>▪ Closed</li> </ul>
Switch cycles	Shows number of all performed switch cycles.	Positive integer
Max. switch cycles number	Shows the maximal number of guaranteed switch cycles.	Positive integer

### Output values for double pulse output

The **Double pulse output** submenu contains all the parameters needed to display the current measured values for every double pulse output.

#### Navigation

"Diagnostics" menu → Measured values → Output values → Double pulse output

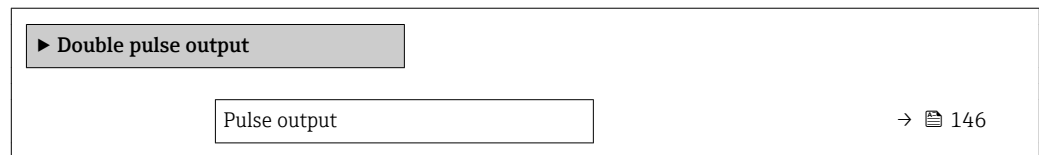

### Parameter overview with brief description

Parameter	Description	User interface
Pulse output	Shows the currently output pulse frequency.	Positive floating-point number

## 11.5 Adapting the measuring device to the process conditions

The following are available for this purpose:

- Basic settings using the **Setup** menu (→ 📄 81)
- Advanced settings using the **Advanced setup** submenu (→ 📄 116)

## 11.6 Performing a totalizer reset

The totalizers are reset in the **Operation** submenu:

- Control Totalizer
- Reset all totalizers

#### Navigation

"Operation" menu → Totalizer handling

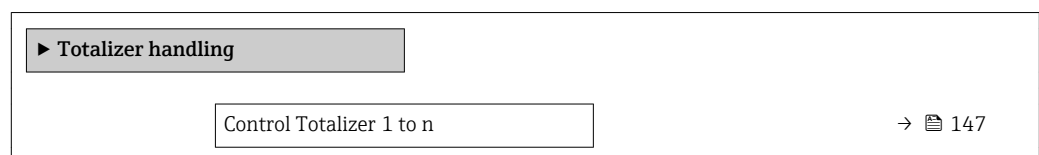

Preset value 1 to n	→  147
Reset all totalizers	→  147

**Parameter overview with brief description**

Parameter	Prerequisite	Description	Selection / User entry	Factory setting
Control Totalizer 1 to n	A process variable is selected in the <b>Assign process variable</b> parameter (→  120) of the <b>Totalizer 1 to n</b> submenu.	Control totalizer value.	<ul style="list-style-type: none"> <li>■ Totalize</li> <li>■ Reset + hold *</li> <li>■ Preset + hold *</li> <li>■ Reset + totalize</li> <li>■ Preset + totalize *</li> <li>■ Hold *</li> </ul>	Totalize
Preset value 1 to n	A process variable is selected in the <b>Assign process variable</b> parameter (→  120) of the <b>Totalizer 1 to n</b> submenu.	Specify start value for totalizer. <i>Dependency</i> The unit of the selected process variable is specified for the totalizer in the <b>Unit totalizer</b> parameter (→  120).	Signed floating-point number	Country-specific: <ul style="list-style-type: none"> <li>■ 0 kg</li> <li>■ 0 lb</li> </ul>
Reset all totalizers	–	Reset all totalizers to 0 and start.	<ul style="list-style-type: none"> <li>■ Cancel</li> <li>■ Reset + totalize</li> </ul>	Cancel

\* Visibility depends on order options or device settings

**11.6.1 Function scope of the "Control Totalizer" parameter**



Options	Description
Totalize	The totalizer is started or continues running.
Reset + hold	The totaling process is stopped and the totalizer is reset to 0.
Preset + hold	The totaling process is stopped and the totalizer is set to its defined start value from the <b>Preset value</b> parameter.
Reset + totalize	The totalizer is reset to 0 and the totaling process is restarted.
Preset + totalize	The totalizer is set to the defined start value from the <b>Preset value</b> parameter and the totaling process is restarted.
Hold	Totalizing is stopped.

**11.6.2 Function scope of the "Reset all totalizers" parameter**

Options	Description
Cancel	No action is executed and the user exits the parameter.
Reset + totalize	Resets all totalizers to 0 and restarts the totaling process. This deletes all the flow values previously totalized.

## 11.7 Showing data logging

The **Extended HistoROM** application package must be enabled in the device (order option) for the **Data logging** submenu to appear. This contains all the parameters for the measured value history.

-  Data logging is also available via:
  - Plant Asset Management Tool FieldCare →  72.
  - Web browser

### Function range

- A total of 1000 measured values can be stored
- 4 logging channels
- Adjustable logging interval for data logging
- Displays the measured value trend for each logging channel in the form of a chart

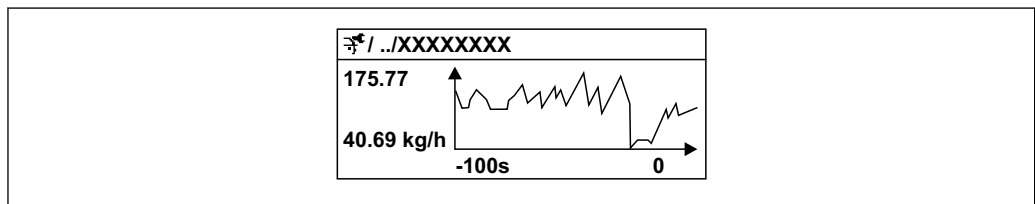

A0016357

 26 Chart of a measured value trend







- x-axis: depending on the number of channels selected displays 250 to 1000 measured values of a process variable.
- y-axis: displays the approximate measured value span and constantly adapts this to the ongoing measurement.

-  If the length of the logging interval or the assignment of the process variables to the channels is changed, the content of the data logging is deleted.

### Navigation

"Diagnostics" menu → Data logging







▶ **Data logging**

Assign channel 1	→  150
Assign channel 2	→  151
Assign channel 3	→  151
Assign channel 4	→  151
Logging interval	→  151
Clear logging data	→  151
Data logging	→  151

Logging delay	→ 📄 151
Data logging control	→ 📄 151
Data logging status	→ 📄 152
Entire logging duration	→ 📄 152
▶ Display channel 1	
▶ Display channel 2	
▶ Display channel 3	
▶ Display channel 4	

Parameter overview with brief description

Parameter	Prerequisite	Description	Selection / User entry / User interface	Factory setting
Assign channel 1	The <b>Extended HistoROM</b> application package is available.	Assign process variable to logging channel.	<ul style="list-style-type: none"> <li>■ Off</li> <li>■ Mass flow</li> <li>■ Volume flow</li> <li>■ Corrected volume flow *</li> <li>■ Target mass flow *</li> <li>■ Carrier mass flow *</li> <li>■ Target volume flow *</li> <li>■ Carrier volume flow *</li> <li>■ Target corrected volume flow *</li> <li>■ Carrier corrected volume flow *</li> <li>■ Density</li> <li>■ Reference density *</li> <li>■ Reference density alternative *</li> <li>■ GSV flow *</li> <li>■ GSV flow alternative *</li> <li>■ NSV flow *</li> <li>■ NSV flow alternative *</li> <li>■ S&amp;W volume flow *</li> <li>■ Water cut *</li> <li>■ Oil density *</li> <li>■ Water density *</li> <li>■ Oil mass flow *</li> <li>■ Water mass flow *</li> <li>■ Oil volume flow *</li> <li>■ Water volume flow *</li> <li>■ Oil corrected volume flow *</li> <li>■ Water corrected volume flow *</li> <li>■ Concentration *</li> <li>■ Temperature</li> <li>■ Carrier pipe temperature *</li> <li>■ Electronic temperature</li> <li>■ Oscillation frequency 0</li> <li>■ Oscillation amplitude *</li> <li>■ Frequency fluctuation 0 *</li> <li>■ Oscillation damping 0 *</li> <li>■ Oscillation damping fluctuation 0 *</li> <li>■ Signal asymmetry *</li> <li>■ Exciter current 0 *</li> <li>■ HBSI *</li> <li>■ Current output 1 *</li> <li>■ Current output 2 *</li> </ul>	Off

Parameter	Prerequisite	Description	Selection / User entry / User interface	Factory setting
			<ul style="list-style-type: none"> <li>▪ Current output 3 *</li> <li>▪ Current output 4 *</li> <li>▪ Pressure</li> <li>▪ Application specific output 1 *</li> <li>▪ Index inhomogeneous medium</li> <li>▪ Application specific output 0 *</li> <li>▪ Index suspended bubbles *</li> </ul>	
Assign channel 2	<p>The <b>Extended HistoROM</b> application package is available.</p> <p> The software options currently enabled are displayed in the <b>Software option overview</b> parameter.</p>	Assign process variable to logging channel.	Picklist, see <b>Assign channel 1</b> parameter (→  150)	Off
Assign channel 3	<p>The <b>Extended HistoROM</b> application package is available.</p> <p> The software options currently enabled are displayed in the <b>Software option overview</b> parameter.</p>	Assign process variable to logging channel.	Picklist, see <b>Assign channel 1</b> parameter (→  150)	Off
Assign channel 4	<p>The <b>Extended HistoROM</b> application package is available.</p> <p> The software options currently enabled are displayed in the <b>Software option overview</b> parameter.</p>	Assign process variable to logging channel.	Picklist, see <b>Assign channel 1</b> parameter (→  150)	Off
Logging interval	The <b>Extended HistoROM</b> application package is available.	Define the logging interval for data logging. This value defines the time interval between the individual data points in the memory.	0.1 to 3 600.0 s	1.0 s
Clear logging data	The <b>Extended HistoROM</b> application package is available.	Clear the entire logging data.	<ul style="list-style-type: none"> <li>▪ Cancel</li> <li>▪ Clear data</li> </ul>	Cancel
Data logging	–	Select the data logging method.	<ul style="list-style-type: none"> <li>▪ Overwriting</li> <li>▪ Not overwriting</li> </ul>	Overwriting
Logging delay	In the <b>Data logging</b> parameter, the <b>Not overwriting</b> option is selected.	Enter the time delay for measured value logging.	0 to 999 h	0 h
Data logging control	In the <b>Data logging</b> parameter, the <b>Not overwriting</b> option is selected.	Start and stop measured value logging.	<ul style="list-style-type: none"> <li>▪ None</li> <li>▪ Delete + start</li> <li>▪ Stop</li> </ul>	None

Parameter	Prerequisite	Description	Selection / User entry / User interface	Factory setting
Data logging status	In the <b>Data logging</b> parameter, the <b>Not overwriting</b> option is selected.	Displays the measured value logging status.	<ul style="list-style-type: none"> <li>■ Done</li> <li>■ Delay active</li> <li>■ Active</li> <li>■ Stopped</li> </ul>	Done
Entire logging duration	In the <b>Data logging</b> parameter, the <b>Not overwriting</b> option is selected.	Displays the total logging duration.	Positive floating-point number	0 s













\* Visibility depends on order options or device settings



## 12 Diagnostics and troubleshooting

### 12.1 General troubleshooting

For local display

Error	Possible causes	Solution
Local display dark and no output signals	Supply voltage does not match the value indicated on the nameplate.	Apply the correct supply voltage →  37.
Local display dark and no output signals	The polarity of the supply voltage is wrong.	Correct the polarity.
Local display dark and no output signals	No contact between connecting cables and terminals.	Check the connection of the cables and correct if necessary.
Local display dark and no output signals	Terminals are not plugged into the I/O electronics module correctly. Terminals are not plugged into the main electronics module correctly.	Check terminals.
Local display dark and no output signals	I/O electronics module is defective. Main electronics module is defective.	Order spare part →  179.
Local display is dark, but signal output is within the valid range	Display is set too bright or too dark.	<ul style="list-style-type: none"> <li>▪ Set the display brighter by simultaneously pressing  + .</li> <li>▪ Set the display darker by simultaneously pressing  + .</li> </ul>
Local display is dark, but signal output is within the valid range	The cable of the display module is not plugged in correctly.	Insert the plug correctly into the main electronics module and display module.
Local display is dark, but signal output is within the valid range	Display module is defective.	Order spare part →  179.
Backlighting of local display is red	Diagnostic event with "Alarm" diagnostic behavior has occurred.	Take remedial measures →  163
Text on local display appears in a foreign language and cannot be understood.	Incorrect operating language is configured.	<ol style="list-style-type: none"> <li>1. Press  +  for 2 s ("home position").</li> <li>2. Press .</li> <li>3. Set the desired language in the <b>Display language</b> parameter (→  127).</li> </ol>
Message on local display: "Communication Error" "Check Electronics"	Communication between the display module and the electronics is interrupted.	<ul style="list-style-type: none"> <li>▪ Check the cable and the connector between the main electronics module and display module.</li> <li>▪ Order spare part →  179.</li> </ul>

*For output signals*

Error	Possible causes	Solution
Signal output outside the valid range	Main electronics module is defective.	Order spare part → 179.
Device shows correct value on local display, but signal output is incorrect, though in the valid range.	Configuration error	Check and correct the parameter configuration.
Device measures incorrectly.	Configuration error or device is operated outside the application.	1. Check and correct parameter configuration. 2. Observe limit values specified in the "Technical Data".

*For access*

Error	Possible causes	Solution
No write access to parameters	Hardware write protection enabled	Set the write protection switch on main electronics module to the <b>OFF</b> position → 137.
No write access to parameters	Current user role has limited access authorization	1. Check user role → 61. 2. Enter correct customer-specific access code → 62.
No connection via Modbus RS485	Modbus RS485 bus cable connected incorrectly	Check terminal assignment → 36.
No connection via Modbus RS485	Modbus RS485 cable incorrectly terminated	Check terminating resistor → 45.
No connection via Modbus RS485	Incorrect settings for the communication interface	Check the Modbus RS485 configuration → 85.
Not connecting to Web server	Web server disabled	Using the "FieldCare" or "DeviceCare" operating tool, check whether the Web server of the measuring device is enabled, and enable it if necessary → 68.
	Incorrect setting for the Ethernet interface of the computer	1. Check the properties of the Internet protocol (TCP/IP) → 64 → 65. 2. Check the network settings with the IT manager.
Not connecting to Web server	Incorrect IP address	Check the IP address: 192.168.1.212 → 64 → 65
Not connecting to Web server	Incorrect WLAN access data	<ul style="list-style-type: none"> <li>▪ Check WLAN network status.</li> <li>▪ Log on to the device again using WLAN access data.</li> <li>▪ Verify that WLAN is enabled on the measuring device and operating device → 64.</li> </ul>
	WLAN communication disabled	–
Not connecting to Web server, FieldCare or DeviceCare	No WLAN network available	<ul style="list-style-type: none"> <li>▪ Check if WLAN reception is present: LED on display module is lit blue</li> <li>▪ Check if WLAN connection is enabled: LED on display module flashes blue</li> <li>▪ Switch on instrument function.</li> </ul>

Error	Possible causes	Solution
Network connection not present or unstable	WLAN network is weak.	<ul style="list-style-type: none"> <li>▪ Operating device is outside of reception range: Check network status on operating device.</li> <li>▪ To improve network performance, use an external WLAN antenna.</li> </ul>
	Parallel WLAN and Ethernet communication	<ul style="list-style-type: none"> <li>▪ Check network settings.</li> <li>▪ Temporarily enable only the WLAN as an interface.</li> </ul>
Web browser frozen and operation no longer possible	Data transfer active	Wait until data transfer or current action is finished.
	Connection lost	<ol style="list-style-type: none"> <li>1. Check cable connection and power supply.</li> <li>2. Refresh the Web browser and restart if necessary.</li> </ol>
Content of Web browser incomplete or difficult to read	Not using optimum version of Web server.	<ol style="list-style-type: none"> <li>1. Use the correct Web browser version → 63.</li> <li>2. Clear the Web browser cache and restart the Web browser.</li> </ol>
	Unsuitable view settings.	Change the font size/display ratio of the Web browser.
No or incomplete display of contents in the Web browser	<ul style="list-style-type: none"> <li>▪ JavaScript not enabled</li> <li>▪ JavaScript cannot be enabled</li> </ul>	<ol style="list-style-type: none"> <li>1. Enable JavaScript.</li> <li>2. Enter <code>http://XXX.XXX.X.XXX/basic.html</code> as the IP address.</li> </ol>
Operation with FieldCare or DeviceCare via CDI-RJ45 service interface (port 8000)	Firewall of computer or network is preventing communication	Depending on the settings of the firewall used on the computer or in the network, the firewall must be adapted or disabled to allow FieldCare/DeviceCare access.
Flashing of firmware with FieldCare or DeviceCare via CDI-RJ45 service interface (via port 8000 or TFTP ports)	Firewall of computer or network is preventing communication	Depending on the settings of the firewall used on the computer or in the network, the firewall must be adapted or disabled to allow FieldCare/DeviceCare access.

## 12.2 Diagnostic information via light emitting diodes

### 12.2.1 Transmitter

Different LEDs in the transmitter provide information on the device status.

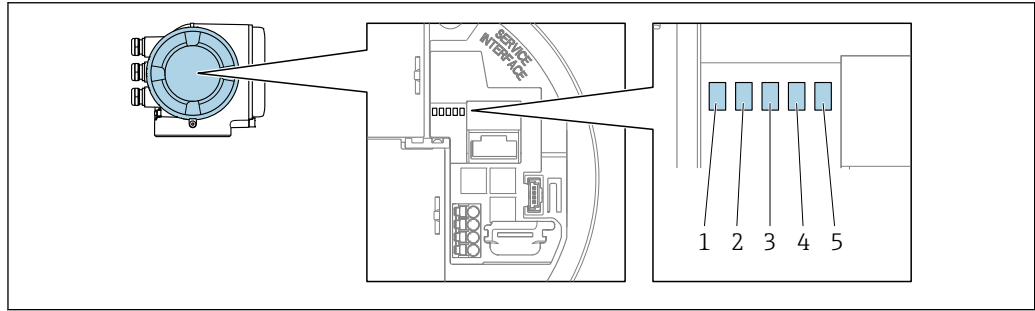

A0029629

- 1 Supply voltage
- 2 Device status
- 3 Not used
- 4 Communication
- 5 Service interface (CDI) active

LED	Color	Meaning
1 Supply voltage	Off	Supply voltage is off or too low.
	Green	Supply voltage is ok.
2 Device status (normal operation)	Off	Firmware error
	Green	Device status is ok.
	Flashing green	Device is not configured.
	Red	A diagnostic event with "Alarm" diagnostic behavior has occurred.
	Flashing red	A diagnostic event with "Warning" diagnostic behavior has occurred.
2 Device status (during start-up)	Flashes red slowly	If > 30 seconds: problem with the boot loader.
	Flashes red quickly	If > 30 seconds: compatibility problem when reading the firmware.
3 Not used	-	-
4 Communication	Off	Communication not active.
	White	Communication active.
5 Service interface (CDI)	Off	Not connected or no connection established.
	Yellow	Connected and connection established.
	Flashing yellow	Service interface active.

## 12.3 Diagnostic information on local display

### 12.3.1 Diagnostic message

Faults detected by the self-monitoring system of the measuring device are displayed as a diagnostic message in alternation with the operational display.

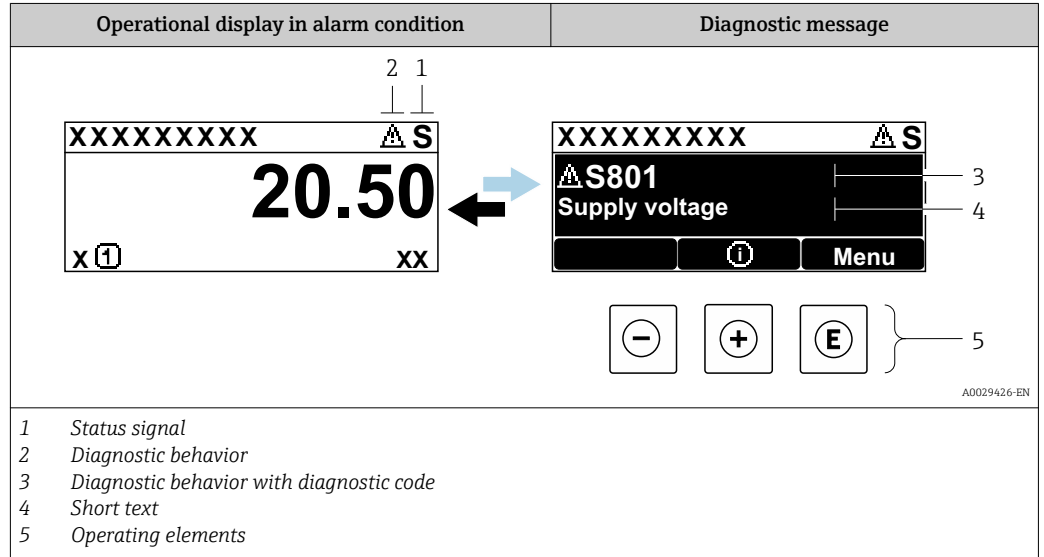

If two or more diagnostic events are pending simultaneously, only the message of the diagnostic event with the highest priority is shown.

- i** Other diagnostic events that have occurred can be displayed in the **Diagnostics** menu:
  - Via parameter → 168
  - Via submenus → 169



#### Status signals

The status signals provide information on the state and reliability of the device by categorizing the cause of the diagnostic information (diagnostic event).

- i** The status signals are categorized according to VDI/VDE 2650 and NAMUR Recommendation NE 107: F = Failure, C = Function Check, S = Out of Specification, M = Maintenance Required

Symbol	Meaning
<b>F</b>	<b>Failure</b> A device error has occurred. The measured value is no longer valid.
<b>C</b>	<b>Function check</b> The device is in service mode (e.g. during a simulation).
<b>S</b>	<b>Out of specification</b> The device is operated: Outside its technical specification limits (e.g. outside the process temperature range)
<b>M</b>	<b>Maintenance required</b> Maintenance is required. The measured value remains valid.

**Diagnostic behavior**



Symbol	Meaning
	<b>Alarm</b> <ul style="list-style-type: none"> <li>Measurement is interrupted.</li> <li>Signal outputs and totalizers assume the defined alarm condition.</li> <li>A diagnostic message is generated.</li> </ul>
	<b>Warning</b> Measurement is resumed. The signal outputs and totalizers are not affected. A diagnostic message is generated.

**Diagnostic information**

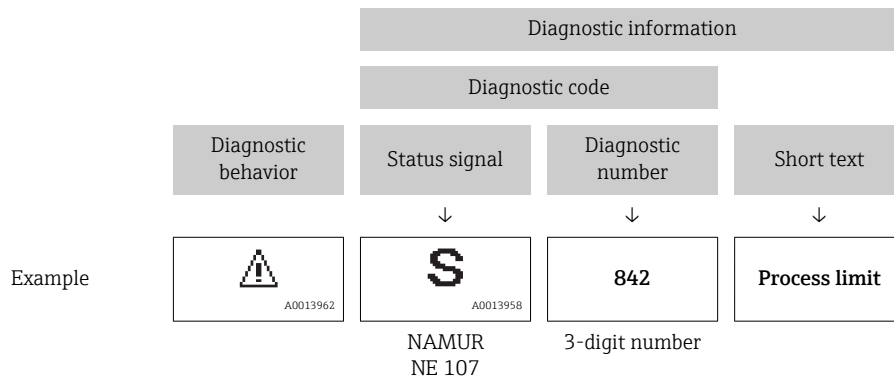
The fault can be identified using the diagnostic information. The short text helps you by providing information about the fault. In addition, the corresponding symbol for the diagnostic behavior is displayed in front of the diagnostic information on the local display.



**Operating elements**

Key	Meaning
	<b>Plus key</b> <i>In a menu, submenu</i> Opens the message about remedy information.
	<b>Enter key</b> <i>In a menu, submenu</i> Opens the operating menu.

### 12.3.2 Calling up remedial measures

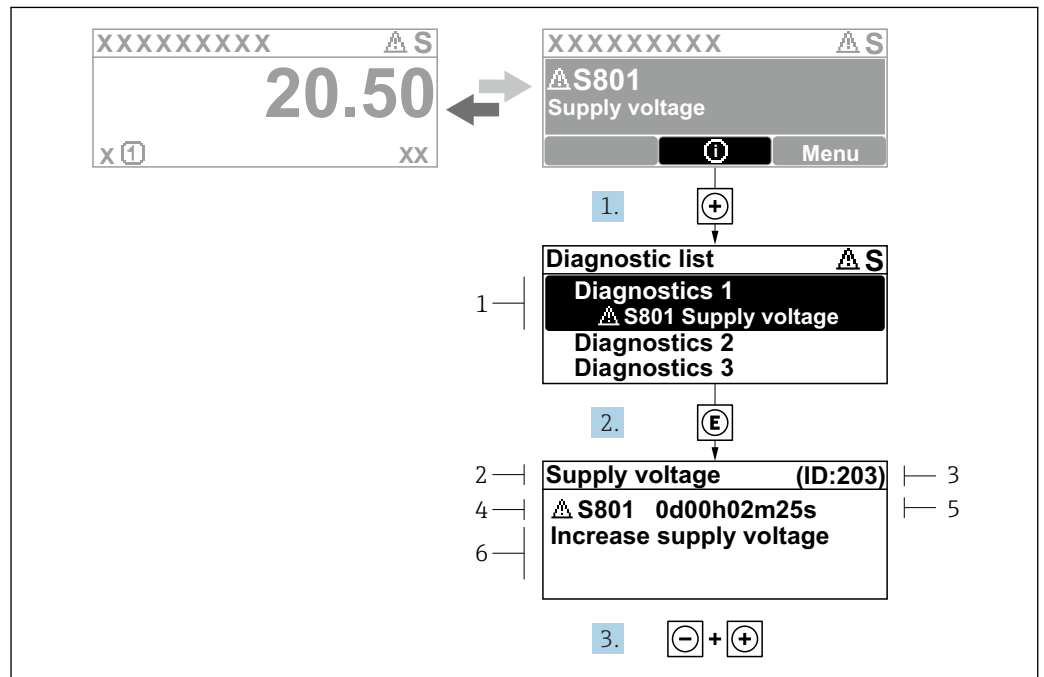

A0029431-EN

27 Message about remedial measures

- 1 Diagnostic information
- 2 Short text
- 3 Service ID
- 4 Diagnostic behavior with diagnostic code
- 5 Operation time of occurrence
- 6 Remedial measures

1. The user is in the diagnostic message.  
Press **+** (Ⓛ symbol).  
↳ The **Diagnostic list** submenu opens.
2. Select the desired diagnostic event with **+** or **-** and press **E** .  
↳ The message about the remedial measures opens.
3. Press **-** + **+** simultaneously.  
↳ The message about the remedial measures closes.

The user is in the **Diagnostics** menu at an entry for a diagnostics event, e.g. in the **Diagnostic list** submenu or **Previous diagnostics** parameter.

1. Press **E**.  
↳ The message for the remedial measures for the selected diagnostic event opens.
2. Press **-** + **+** simultaneously.  
↳ The message for the remedial measures closes.

## 12.4 Diagnostic information in the Web browser

### 12.4.1 Diagnostic options

Any faults detected by the measuring device are displayed in the Web browser on the home page once the user has logged on.

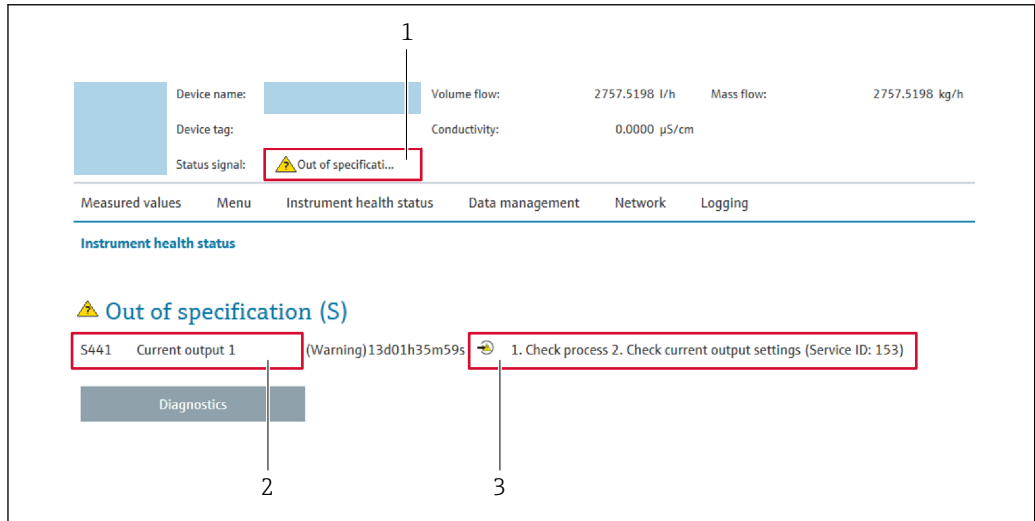

A0031056

- 1 Status area with status signal
- 2 Diagnostic information
- 3 Remedy information with Service ID

**i** In addition, diagnostic events which have occurred can be shown in the **Diagnostics** menu:

- Via parameter → 168
- Via submenu → 169

### Status signals

The status signals provide information on the state and reliability of the device by categorizing the cause of the diagnostic information (diagnostic event).

Symbol	Meaning
	<b>Failure</b> A device error has occurred. The measured value is no longer valid.
	<b>Function check</b> The device is in service mode (e.g. during a simulation).
	<b>Out of specification</b> The device is operated: Outside its technical specification limits (e.g. outside the process temperature range)
	<b>Maintenance required</b> Maintenance is required. The measured value is still valid.

**i** The status signals are categorized in accordance with VDI/VDE 2650 and NAMUR Recommendation NE 107.



### 12.4.2 Calling up remedy information

Remedy information is provided for every diagnostic event to ensure that problems can be rectified quickly. These measures are displayed in red along with the diagnostic event and the related diagnostic information.

## 12.5 Diagnostic information in FieldCare or DeviceCare

### 12.5.1 Diagnostic options

Any faults detected by the measuring device are displayed on the home page of the operating tool once the connection has been established.

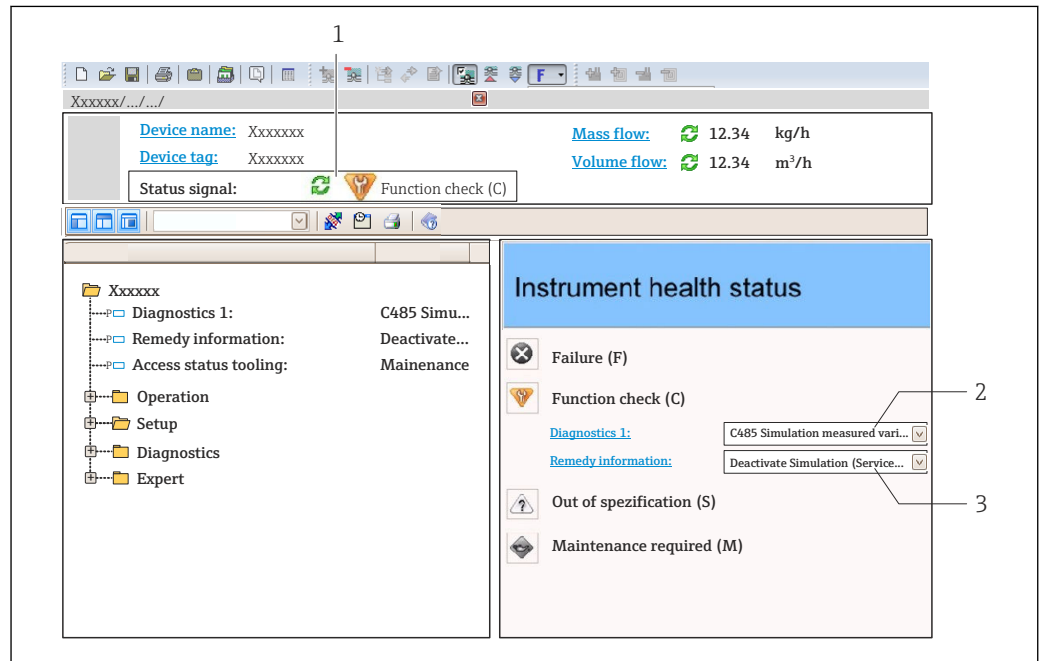

- 1 Status area with status signal → 157
- 2 Diagnostic information → 158
- 3 Remedy information with Service ID

**i** In addition, diagnostic events which have occurred can be shown in the **Diagnostics** menu:

- Via parameter → 168
- Via submenu → 169

### Diagnostic information

The fault can be identified using the diagnostic information. The short text helps you by providing information about the fault. In addition, the corresponding symbol for the diagnostic behavior is displayed in front of the diagnostic information on the local display.

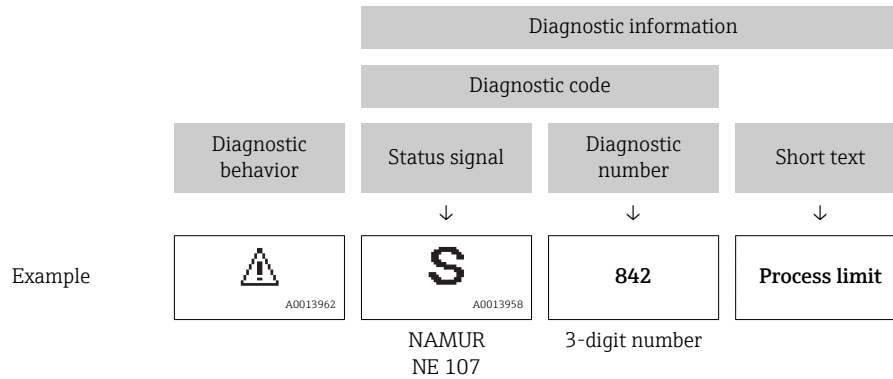

## 12.5.2 Calling up remedy information

Remedy information is provided for every diagnostic event to ensure that problems can be rectified quickly:

- On the home page  
Remedy information is displayed in a separate field below the diagnostics information.
- In the **Diagnostics** menu  
Remedy information can be called up in the working area of the user interface.

The user is in the **Diagnostics** menu.



1. Call up the desired parameter.
2. On the right in the working area, mouse over the parameter.
  - ↳ A tool tip with remedy information for the diagnostic event appears.

## 12.6 Diagnostic information via communication interface

### 12.6.1 Reading out diagnostic information

Diagnostic information can be read out via Modbus RS485 register addresses.

- Via register address **6821** (data type = string): diagnosis code, e.g. F270
- Via register address **6859** (data type = integer): diagnosis number, e.g. 270

 For an overview of diagnostic events with diagnosis number and diagnosis code  
→  163

### 12.6.2 Configuring error response mode

The error response mode for Modbus RS485 communication can be configured in the **Communication** submenu using 2 parameters.

#### Navigation path

Setup → Communication

*Parameter overview with brief description*

Parameters	Description	Selection	Factory setting
Failure mode	<p>Select measured value output behavior when a diagnostic message occurs via Modbus communication.</p> <p><b>i</b> This effect of this parameter depends on the option selected in the <b>Assign diagnostic behavior</b> parameter.</p>	<ul style="list-style-type: none"> <li>▪ NaN value</li> <li>▪ Last valid value</li> </ul> <p><b>i</b> NaN ≙ not a number</p>	NaN value

## 12.7 Adapting the diagnostic information

### 12.7.1 Adapting the diagnostic behavior

Each item of diagnostic information is assigned a specific diagnostic behavior at the factory. The user can change this assignment for specific diagnostic information in the **Diagnostic behavior** submenu.

Expert → System → Diagnostic handling → Diagnostic behavior

You can assign the following options to the diagnostic number as the diagnostic behavior:

Options	Description
Alarm	The device stops measurement. The measured value output via Modbus RS485 and the totalizers assume the defined alarm condition. A diagnostic message is generated. The background lighting changes to red.
Warning	The device continues to measure. The measured value output via Modbus RS485 and the totalizers are not affected. A diagnostic message is generated.
Logbook entry only	The device continues to measure. The diagnostic message is displayed only in the <b>Event logbook</b> submenu ( <b>Event list</b> submenu) and is not displayed in alternation with the operational display.
Off	The diagnostic event is ignored, and no diagnostic message is generated or entered.

## 12.8 Overview of diagnostic information

**i** The amount of diagnostic information and the number of measured variables affected increase if the measuring device has one or more application packages.

**i** In the case of some items of diagnostic information, the diagnostic behavior can be changed. Change the diagnostic information →  163

Diagnostic number	Short text	Remedy instructions	Status signal [from the factory]	Diagnostic behavior [from the factory]
<b>Diagnostic of sensor</b>				
022	Temperature sensor defective	1. Check or replace sensor electronic module (ISEM) 2. If available: Check connection cable between sensor and transmitter 3. Replace sensor	F	Alarm
046	Sensor limit exceeded	1. Inspect sensor 2. Check process condition	S	Warning <sup>1)</sup>
062	Sensor connection faulty	1. Check or replace sensor electronic module (ISEM) 2. If available: Check connection cable between sensor and transmitter 3. Replace sensor	F	Alarm
063	Exciter current faulty	1. Check or replace sensor electronic module (ISEM) 2. If available: Check connection cable between sensor and transmitter 3. Replace sensor	S	Alarm
082	Data storage	1. Check module connections 2. Change electronic modules	F	Alarm
083	Memory content	1. Restart device 2. Restore HistoROM S-DAT backup ('Device reset' parameter) 3. Replace HistoROM S-DAT	F	Alarm
140	Sensor signal asymmetrical	1. Check or replace sensor electronic module (ISEM) 2. If available: Check connection cable between sensor and transmitter 3. Replace sensor	S	Alarm <sup>1)</sup>
144	Measurement error too high	1. Check or change sensor 2. Check process conditions	F	Alarm <sup>1)</sup>
<b>Diagnostic of electronic</b>				
201	Device failure	Restart device	F	Alarm
242	Software incompatible	1. Check software 2. Flash or change main electronics module	F	Alarm
252	Modules incompatible	1. Check electronic modules 2. Check if correct modules are available (e.g. NEx, Ex) 3. Replace electronic modules	F	Alarm
252	Modules incompatible	1. Check if correct electronic modul is plugged 2. Replace electronic module	F	Alarm
262	Sensor electronic connection faulty	1. Check or replace connection cable between sensor electronic module (ISEM) and main electronics 2. Check or replace ISEM or main electronics	F	Alarm
270	Main electronic failure	Change main electronic module	F	Alarm
271	Main electronic failure	1. Restart device 2. Change main electronic module	F	Alarm

Diagnostic number	Short text	Remedy instructions	Status signal [from the factory]	Diagnostic behavior [from the factory]
272	Main electronic failure	Restart device	F	Alarm
273	Main electronic failure	Change electronic	F	Alarm
275	I/O module 1 to n defective	Change I/O module	F	Alarm
276	I/O module 1 to n faulty	1. Restart device 2. Change I/O module	F	Alarm
283	Memory content	Reset device	F	Alarm
283	Memory content	Restart device	F	Alarm
302	Device verification active	Device verification active, please wait.	C	Warning
303	I/O 1 to n configuration changed	1. Apply I/O module configuration (parameter 'Apply I/O configuration') 2. Afterwards reload device description and check wiring	M	Warning
311	Electronic failure	1. Do not reset device 2. Contact service	M	Warning
332	Writing in HistoROM backup failed	Replace user interface board Ex d/XP: replace transmitter	F	Alarm
361	I/O module 1 to n faulty	1. Restart device 2. Check electronic modules 3. Change I/O Modul or main electronics	F	Alarm
372	Sensor electronic (ISEM) faulty	1. Restart device 2. Check if failure recurs 3. Replace sensor electronic module (ISEM)	F	Alarm
373	Sensor electronic (ISEM) faulty	Transfer data or reset device	F	Alarm
374	Sensor electronic (ISEM) faulty	1. Restart device 2. Check if failure recurs 3. Replace sensor electronic module (ISEM)	S	Warning <sup>1)</sup>
375	I/O- 1 to n communication failed	1. Restart device 2. Check if failure recurs 3. Replace module rack inclusive electronic modules	F	Alarm
378	Supply voltage ISEM faulty	Check supply voltage to the ISEM	F	Alarm
382	Data storage	1. Insert T-DAT 2. Replace T-DAT	F	Alarm
383	Memory content	1. Restart device 2. Delete T-DAT via 'Reset device' parameter 3. Replace T-DAT	F	Alarm
387	HistoROM data faulty	Contact service organization	F	Alarm
<b>Diagnostic of configuration</b>				
330	Flash file invalid	1. Update firmware of device 2. Restart device	M	Warning

Diagnostic number	Short text	Remedy instructions	Status signal [from the factory]	Diagnostic behavior [from the factory]
331	Firmware update failed	1. Update firmware of device 2. Restart device	F	Warning
410	Data transfer	1. Check connection 2. Retry data transfer	F	Alarm
412	Processing download	Download active, please wait	C	Warning
431	Trim 1 to n	Carry out trim	C	Warning
437	Configuration incompatible	Restart device	F	Alarm
438	Dataset	1. Check data set file 2. Check device configuration 3. Up- and download new configuration	M	Warning
441	Current output 1 to n	1. Check process 2. Check current output settings	S	Warning <sup>1)</sup>
442	Frequency output 1 to n	1. Check process	S	Warning <sup>1)</sup>
442	Frequency output 1 to n	2. Check frequency output settings	S	Warning
443	Pulse output 1 to n	1. Check process 2. Check pulse output settings	S	Warning <sup>1)</sup>
444	Current input 1 to n	1. Check process 2. Check current input settings	S	Warning <sup>1)</sup>
453	Flow override	Deactivate flow override	C	Warning
484	Failure mode simulation	Deactivate simulation	C	Alarm
485	Measured variable simulation	Deactivate simulation	C	Warning
486	Current input 1 to n simulation	Deactivate simulation	C	Warning
491	Current output 1 to n simulation	Deactivate simulation	C	Warning
492	Simulation frequency output 1 to n	Deactivate simulation frequency output	C	Warning
493	Simulation pulse output 1 to n	Deactivate simulation pulse output	C	Warning
494	Switch output simulation 1 to n	Deactivate simulation switch output	C	Warning
495	Diagnostic event simulation	Deactivate simulation	C	Warning
496	Status input simulation	Deactivate simulation status input	C	Warning
502	CT activation/ deactivation failed	Follow the sequence of the custody transfer activation/deactivation: First authorized user login, then set the DIP switch on the main electronic module	C	Warning
520	I/O 1 to n hardware configuration invalid	1. Check I/O hardware configuration 2. Replace wrong I/O module 3. Plug the module of double pulse output on correct slot	F	Alarm





Diagnostic number	Short text	Remedy instructions	Status signal [from the factory]	Diagnostic behavior [from the factory]
528	Concentration calculation not possible	Out of valid range of the selected calculation algorithm 1. Check concentration settings 2. Check measured values, e.g. density or temperature	S	Alarm
529	Concentration calculation not accurate	Out of valid range of the selected calculation algorithm 1. Check concentration settings 2. Check measured values, e.g. density or temperature	S	Warning
537	Configuration	1. Check IP addresses in network 2. Change IP address	F	Warning
540	Custody transfer mode failed	1. Power off device and toggle DIP switch 2. Deactivate custody transfer mode 3. Reactivate custody transfer mode 4. Check electronic components	F	Alarm
543	Double pulse output	1. Check process 2. Check pulse output settings	S	Warning
593	Double pulse output simulation	Deactivate simulation pulse output	C	Warning
594	Relay output simulation	Deactivate simulation switch output	C	Warning
599	Custody transfer logbook full	1. Deactivate custody transfer mode 2. Clear custody transfer logbook (all 30 entries) 3. Activate custody transfer mode	F	Warning
<b>Diagnostic of process</b>				
803	Current loop	1. Check wiring 2. Change I/O module	F	Alarm
830	Sensor temperature too high	Reduce ambient temp. around the sensor housing	S	Warning <sup>1)</sup>
831	Sensor temperature too low	Increase ambient temp. around the sensor housing	S	Warning <sup>1)</sup>
832	Electronic temperature too high	Reduce ambient temperature	S	Warning <sup>1)</sup>
833	Electronic temperature too low	Increase ambient temperature	S	Warning <sup>1)</sup>
834	Process temperature too high	Reduce process temperature	S	Warning <sup>1)</sup>
835	Process temperature too low	Increase process temperature	S	Warning <sup>1)</sup>
842	Process limit	Low flow cut off active! 1. Check low flow cut off configuration	S	Warning <sup>1)</sup>
862	Partly filled pipe	1. Check for gas in process 2. Adjust detection limits	S	Warning <sup>1)</sup>
882	Input signal	1. Check input configuration 2. Check external device or process conditions	F	Alarm



Diagnostic number	Short text	Remedy instructions	Status signal [from the factory]	Diagnostic behavior [from the factory]
910	Tubes not oscillating	1. Check electronic 2. Inspect sensor	F	Alarm
912	Medium inhomogeneous	1. Check process cond. 2. Increase system pressure	S	Warning <sup>1)</sup>
913	Medium unsuitable	1. Check process conditions 2. Check electronic modules or sensor	S	Warning <sup>1)</sup>
941	API temperature out of specification	1. Check process temperature with selected API commodity group 2. Check API related parameters	S	Warning <sup>1)</sup>
942	API density out of specification	1. Check process density with selected API commodity group 2. Check API related parameters	S	Warning <sup>1)</sup>
943	API pressure out of specification	1. Check process pressure with selected API commodity group 2. Check API related parameters	S	Warning <sup>1)</sup>
944	Monitoring failed	Check process conditions for Heartbeat Monitoring	S	Warning <sup>1)</sup>
948	Oscillation damping too high	Check process conditions	S	Warning <sup>1)</sup>

1) Diagnostic behavior can be changed.

## 12.9 Pending diagnostic events



The **Diagnostics** menu allows the user to view the current diagnostic event and the previous diagnostic event separately.

-  To call up the measures to rectify a diagnostic event:
- Via local display →  159
  - Via Web browser →  161
  - Via "FieldCare" operating tool →  162
  - Via "DeviceCare" operating tool →  162

-  Other pending diagnostic events can be displayed in the **Diagnostic list** submenu →  169

### Navigation

"Diagnostics" menu

 <b>Diagnostics</b>	
Actual diagnostics	→  169
Previous diagnostics	→  169



Operating time from restart	→  169
Operating time	→  169

### Parameter overview with brief description

Parameter	Prerequisite	Description	User interface
Actual diagnostics	A diagnostic event has occurred.	Shows the current occurred diagnostic event along with its diagnostic information. If two or more messages occur simultaneously, the message with the highest priority is shown on the display.	Symbol for diagnostic behavior, diagnostic code and short message.
Previous diagnostics	Two diagnostic events have already occurred.	Shows the diagnostic event that occurred prior to the current diagnostic event along with its diagnostic information.	Symbol for diagnostic behavior, diagnostic code and short message.
Operating time from restart	-	Shows the time the device has been in operation since the last device restart.	Days (d), hours (h), minutes (m) and seconds (s)
Operating time	-	Indicates how long the device has been in operation.	Days (d), hours (h), minutes (m) and seconds (s)

## 12.10 Diagnostic list

Up to 5 currently pending diagnostic events can be displayed in the **Diagnostic list** submenu along with the associated diagnostic information. If more than 5 diagnostic events are pending, the events with the highest priority are shown on the display.

### Navigation path

Diagnostics → Diagnostic list

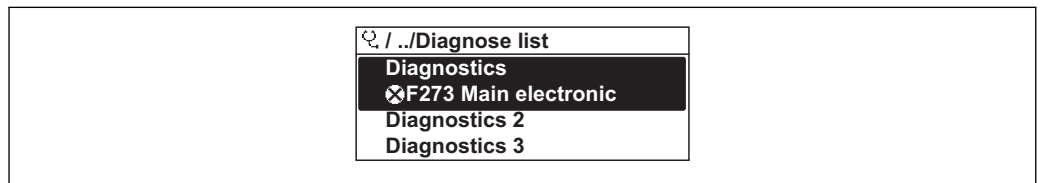

A0014006-EN

28 Taking the example of the local display

To call up the measures to rectify a diagnostic event:

- Via local display → 159
- Via Web browser → 161
- Via "FieldCare" operating tool → 162
- Via "DeviceCare" operating tool → 162

## 12.11 Event logbook

### 12.11.1 Reading out the event logbook

A chronological overview of the event messages that have occurred is provided in the **Events list** submenu.

#### Navigation path

**Diagnostics** menu → **Event logbook** submenu → Event list

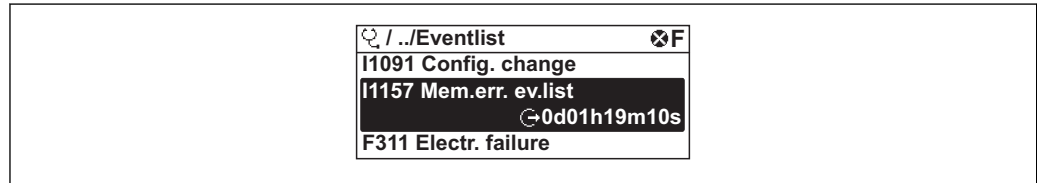

A0014008-EN

29 Taking the example of the local display

- A maximum of 20 event messages can be displayed in chronological order.
- If the **Extended HistoROM** application package (order option) is enabled in the device, the event list can contain up to 100 entries .

The event history includes entries for:

- Diagnostic events → 163
- Information events → 171

In addition to the operation time of its occurrence, each event is also assigned a symbol that indicates whether the event has occurred or is ended:

- Diagnostic event
  - : Occurrence of the event
  - : End of the event
- Information event
  - : Occurrence of the event

- To call up the measures to rectify a diagnostic event:
  - Via local display → 159
  - Via Web browser → 161
  - Via "FieldCare" operating tool → 162
  - Via "DeviceCare" operating tool → 162

- For filtering the displayed event messages → 170

### 12.11.2 Filtering the event logbook

Using the **Filter options** parameter you can define which category of event message is displayed in the **Events list** submenu.

#### Navigation path

**Diagnostics** → Event logbook → Filter options

#### Filter categories

- All
- Failure (F)
- Function check (C)
- Out of specification (S)
- Maintenance required (M)
- Information (I)

### 12.11.3 Overview of information events

Unlike a diagnostic event, an information event is displayed in the event logbook only and not in the diagnostic list.

Info number	Info name
I1000	----- (Device ok)
I1079	Sensor changed
I1089	Power on
I1090	Configuration reset
I1091	Configuration changed
I1092	HistoROM backup deleted
I1111	Density adjust failure
I1137	Electronic changed
I1151	History reset
I1155	Reset electronic temperature
I1156	Memory error trend
I1157	Memory error event list
I1209	Density adjustment ok
I1221	Zero point adjust failure
I1222	Zero point adjustment ok
I1256	Display: access status changed
I1278	I/O module restarted
I1335	Firmware changed
I1361	Web server: login failed
I1397	Fieldbus: access status changed
I1398	CDI: access status changed
I1444	Device verification passed
I1445	Device verification failed
I1447	Record application reference data
I1448	Application reference data recorded
I1449	Recording application ref. data failed
I1450	Monitoring off
I1451	Monitoring on
I1457	Measurement error verification failed
I1459	I/O module verification failed
I1460	HBSI verification failed
I1461	Sensor verification failed
I1462	Sensor electronic module verific. failed
I1512	Download started
I1513	Download finished
I1514	Upload started

Info number	Info name
I1515	Upload finished
I1517	Custody transfer active
I1518	Custody transfer inactive
I1618	I/O module 2 replaced
I1619	I/O module 3 replaced
I1621	I/O module 4 replaced
I1622	Calibration changed
I1624	Reset all totalizers
I1625	Write protection activated
I1626	Write protection deactivated
I1627	Web server: login successful
I1628	Display: login successful
I1629	CDI: login successful
I1631	Web server access changed
I1632	Display: login failed
I1633	CDI: login failed
I1634	Reset to factory settings
I1635	Reset to delivery settings
I1639	Max. switch cycles number reached
I1643	Custody transfer logbook cleared
I1649	Hardware write protection activated
I1650	Hardware write protection deactivated
I1651	Custody transfer parameter changed
I1712	New flash file received
I1725	Sensor electronic module (ISEM) changed
I1726	Configuration backup failed

## 12.12 Resetting the measuring device

Using the **Device reset** parameter (→  132) it is possible to reset the entire device configuration or some of the configuration to a defined state.

### 12.12.1 Function scope of the "Device reset" parameter

Options	Description
Cancel	No action is executed and the user exits the parameter.
To delivery settings	Every parameter for which a customer-specific default setting was ordered is reset to this customer-specific value. All other parameters are reset to the factory setting.









Options	Description
Restart device	The restart resets every parameter whose data are in the volatile memory (RAM) to the factory setting (e.g. measured value data). The device configuration remains unchanged.
Restore S-DAT backup	Restore the data that are saved on the S-DAT. The data record is restored from the electronics memory to the S-DAT.  This option is displayed only in an alarm condition.

## 12.13 Device information





The **Device information** submenu contains all parameters that display different information for device identification.

### Navigation

"Diagnostics" menu → Device information

► Device information	
Device tag	→  174
Serial number	→  174
Firmware version	→  174
Device name	→  174
Manufacturer	
Order code	→  174
Extended order code 1	→  174
Extended order code 2	→  174
Extended order code 3	→  174
ENP version	→  174

### Parameter overview with brief description

Parameter	Description	User interface	Factory setting
Device tag	Shows name of measuring point.	Max. 32 characters, such as letters, numbers or special characters (e.g. @, %, /).	Promass
Serial number	Shows the serial number of the measuring device.	Max. 11-digit character string comprising letters and numbers.	–
Firmware version	Shows the device firmware version installed.	Character string in the format xx.yy.zz	–
Device name	Shows the name of the transmitter.  The name can be found on the nameplate of the transmitter.	Promass 300/500	–
Order code	Shows the device order code.  The order code can be found on the nameplate of the sensor and transmitter in the "Order code" field.	Character string composed of letters, numbers and certain punctuation marks (e.g. /).	–
Extended order code 1	Shows the 1st part of the extended order code.  The extended order code can also be found on the nameplate of the sensor and transmitter in the "Ext. ord. cd." field.	Character string	–
Extended order code 2	Shows the 2nd part of the extended order code.  The extended order code can also be found on the nameplate of the sensor and transmitter in the "Ext. ord. cd." field.	Character string	–
Extended order code 3	Shows the 3rd part of the extended order code.  The extended order code can also be found on the nameplate of the sensor and transmitter in the "Ext. ord. cd." field.	Character string	–
ENP version	Shows the version of the electronic nameplate (ENP).	Character string	2.02.00

## 12.14 Firmware history

Release date	Firmware version	Order code for "Firmware version"	Firmware changes	Documentation type	Documentation
09.2019	01.05.zz	Option 64	<ul style="list-style-type: none"> <li>▪ Gas Fraction Handler Adaptive Filter, Gas Entrainment Index</li> <li>▪ Application-specific Input module</li> <li>▪ Upgrading of the Petroleum application package</li> </ul>	Operating Instructions	BA016680/06/EN/04.19
10.2018	01.02.zz	Option 65	<ul style="list-style-type: none"> <li>▪ Integration of "StdBarrelOil" and "MillionStdCubicFeetPerDay" units</li> <li>▪ Modification of the functionality in the "Weighted Averages" Flow Block:               <ul style="list-style-type: none"> <li>▪ Weighted density average</li> <li>▪ Weighted temperature average</li> </ul> </li> </ul>	Operating Instructions	BA016680/06/EN/03.18

Release date	Firmware version	Order code for "Firmware version"	Firmware changes	Documentation type	Documentation
10.2017	01.01.zz	Option 70	<ul style="list-style-type: none"> <li>▪ Petroleum new</li> <li>▪ Concentration update</li> <li>▪ Local display - enhanced performance and data entry via text editor</li> <li>▪ Optimized keypad lock for local display</li> <li>▪ Improvements and enhancements with regard to custody transfer measurement</li> <li>▪ Web server feature update               <ul style="list-style-type: none"> <li>▪ Support for trend data function</li> <li>▪ Heartbeat function enhanced to include detailed results (page 3/4 of the report)</li> </ul> </li> <li>▪ Device configuration as PDF (parameter log, similar to FDT print)</li> <li>▪ Network capability of Ethernet (service) interface</li> <li>▪ Comprehensive Heartbeat feature update</li> <li>▪ Local display - support for WLAN infrastructure mode</li> <li>▪ Implementation of reset code</li> </ul>	Operating Instructions	BA016680/06/EN/02.17
08.2016	01.00.zz	Option 76	Original firmware	Operating Instructions	BA016680/06/EN/01.16



It is possible to flash the firmware to the current version or the previous version using the service interface. For the compatibility of the firmware version, see the "Device history and compatibility" section → 177



 For the compatibility of the firmware version with the previous version, the installed device description files and operating tools, observe the information about the device in the "Manufacturer's information" document.

-  The manufacturer's information is available:
- In the Download Area of the Endress+Hauser web site: [www.endress.com](http://www.endress.com) → Downloads
  - Specify the following details:
    - Product root: e.g. 8F3B  
The product root is the first part of the order code: see the nameplate on the device.
    - Text search: Manufacturer's information
    - Media type: Documentation – Technical Documentation

## 12.15 Device history and compatibility

The device model is documented in the order code on the nameplate of the device (e.g. 8F3BXX-XXX...XXA1-XXXXXX).

Device model	Release	Change compared with earlier model	Compatibility with earlier model
A2	09.2019	I/O module with enhanced performance and functionality: see device firmware 01.05.zz →  175	No
A1	08.2016	-	-

## 13 Maintenance

### 13.1 Maintenance tasks

No special maintenance work is required.

#### 13.1.1 Exterior cleaning

When cleaning the exterior of measuring devices, always use cleaning agents that do not attack the surface of the housing or the seals.

#### 13.1.2 Interior cleaning

Observe the following points for CIP and SIP cleaning:

- Use only cleaning agents to which the process-wetted materials are adequately resistant.
- Observe the maximum permitted medium temperature for the measuring device  
→  202.

### 13.2 Measuring and test equipment

Endress+Hauser offers a wide variety of measuring and test equipment, such as W@M or device tests.

 Your Endress+Hauser Sales Center can provide detailed information on the services.

List of some of the measuring and testing equipment: →  181

### 13.3 Endress+Hauser services

Endress+Hauser offers a wide variety of services for maintenance such as recalibration, maintenance service or device tests.

 Your Endress+Hauser Sales Center can provide detailed information on the services.

## 14 Repair

### 14.1 General notes

#### 14.1.1 Repair and conversion concept

The Endress+Hauser repair and conversion concept provides for the following:



- The measuring devices have a modular design.
- Spare parts are grouped into logical kits with the associated Installation Instructions.
- Repairs are carried out by Endress+Hauser Service or by appropriately trained customers.
- Certified devices can only be converted to other certified devices by Endress+Hauser Service or at the factory.

#### 14.1.2 Notes for repair and conversion

For repair and modification of a measuring device, observe the following notes:

- ▶ Use only original Endress+Hauser spare parts.
- ▶ Carry out the repair according to the Installation Instructions.
- ▶ Observe the applicable standards, federal/national regulations, Ex documentation (XA) and certificates.
- ▶ Document every repair and each conversion and enter them into the *W@M* life cycle management database.

### 14.2 Spare parts

 Measuring device serial number:  
Can be read out via the **Serial number** parameter (→  174) in the **Device information** submenu.

### 14.3 Endress+Hauser services

Endress+Hauser offers a wide range of services.

 Your Endress+Hauser Sales Center can provide detailed information on the services.

### 14.4 Return

The requirements for safe device return can vary depending on the device type and national legislation.

1. Refer to the website for more information:  
<http://www.endress.com/support/return-material>
2. Return the device if repairs or a factory calibration are required, or if the wrong device was ordered or delivered.

## 14.5 Disposal

### 14.5.1 Removing the measuring device

1. Switch off the device.

**⚠ WARNING**

**Danger to persons from process conditions.**

- ▶ Beware of hazardous process conditions such as pressure in the measuring device, high temperatures or aggressive fluids.
2. Carry out the mounting and connection steps from the "Mounting the measuring device" and "Connecting the measuring device" sections in reverse order. Observe the safety instructions.

### 14.5.2 Disposing of the measuring device

**⚠ WARNING**

**Danger to personnel and environment from fluids that are hazardous to health.**

- ▶ Ensure that the measuring device and all cavities are free of fluid residues that are hazardous to health or the environment, e.g. substances that have permeated into crevices or diffused through plastic.

Observe the following notes during disposal:





- ▶ Observe valid federal/national regulations.
- ▶ Ensure proper separation and reuse of the device components.







## 15 Accessories

Various accessories, which can be ordered with the device or subsequently from Endress +Hauser, are available for the device. Detailed information on the order code in question is available from your local Endress+Hauser sales center or on the product page of the Endress+Hauser website: [www.endress.com](http://www.endress.com).



### 15.1 Device-specific accessories

#### 15.1.1 For the transmitter



Accessories	Description
Proline 300 transmitter	<p>Transmitter for replacement or storage. Use the order code to define the following specifications:</p> <ul style="list-style-type: none"> <li>▪ Approvals</li> <li>▪ Output</li> <li>▪ Input</li> <li>▪ Display/operation</li> <li>▪ Housing</li> <li>▪ Software</li> </ul> <p> Order code: O8X3BXX</p> <p> Installation Instructions EA01263D</p>
Remote display and operating module DKX001	<ul style="list-style-type: none"> <li>▪ If ordered directly with the measuring device: Order code for "Display; operation", option O "Remote display 4-line illum.; 10 m (30 ft) Cable; touch control"</li> <li>▪ If ordered separately: <ul style="list-style-type: none"> <li>▪ Measuring device: order code for "Display; operation", option M "W/o, prepared for remote display"</li> <li>▪ DKX001: Via the separate product structure DKX001</li> </ul> </li> <li>▪ If ordered subsequently: DKX001: Via the separate product structure DKX001</li> </ul> <p><b>Mounting bracket for DKX001</b></p> <ul style="list-style-type: none"> <li>▪ If ordered directly: order code for "Accessory enclosed", option RA "Mounting bracket, pipe 1 1/2"</li> <li>▪ If ordered subsequently: order number: 71340960</li> </ul> <p><b>Connecting cable (replacement cable)</b> Via the separate product structure: DKX002</p> <p> Further information on display and operating module DKX001 →  211.</p> <p> Special Documentation SD01763D</p>

External WLAN antenna	<p>External WLAN antenna with 1.5 m (59.1 in) connecting cable and two angle brackets. Order code for "Accessory enclosed", option P8 "Wireless antenna wide area".</p> <ul style="list-style-type: none"> <li> The external WLAN antenna is not suitable for use in hygienic applications.</li> <li>Further information on the WLAN interface →  71.</li> </ul> <p> Order number: 71351317</p> <p> Installation Instructions EA01238D</p>
Protective cover	<p>Is used to protect the measuring device from the effects of the weather: e.g. rainwater, excess heating from direct sunlight.</p> <p> Order number: 71343505</p> <p> Installation Instructions EA01160D</p>



### 15.1.2 For the sensor



Accessories	Description
Heating jacket	<p>Is used to stabilize the temperature of the fluids in the sensor. Water, water vapor and other non-corrosive liquids are permitted for use as fluids.</p> <p> If using oil as a heating medium, please consult with Endress+Hauser.</p> <p>Heating jackets cannot be used with sensors fitted with a rupture disk.</p> <ul style="list-style-type: none"> <li>▪ If ordered together with the measuring device: order code for "Enclosed accessories" <ul style="list-style-type: none"> <li>▪ Option RB "heating jacket, G 1/2" internal thread"</li> <li>▪ Option RC "heating jacket, G 3/4" internal thread"</li> <li>▪ Option RD "Heating jacket, NPT 1/2" internal thread"</li> <li>▪ Option RE "Heating jacket, NPT 3/4" internal thread"</li> </ul> </li> <li>▪ If ordered subsequently: Use the order code with the product root DK8003.</li> </ul> <p> Special Documentation SD02156D</p>

## 15.2 Service-specific accessories

Accessories	Description
Applicator	<p>Software for selecting and sizing Endress+Hauser measuring devices:</p> <ul style="list-style-type: none"> <li>Choice of measuring devices for industrial requirements</li> <li>Calculation of all the necessary data for identifying the optimum flowmeter: e.g. nominal diameter, pressure loss, flow velocity and accuracy.</li> <li>Graphic illustration of the calculation results</li> <li>Determination of the partial order code, administration, documentation and access to all project-related data and parameters over the entire life cycle of a project.</li> </ul> <p>Applicator is available:</p> <ul style="list-style-type: none"> <li>Via the Internet: <a href="https://portal.endress.com/webapp/applicator">https://portal.endress.com/webapp/applicator</a></li> <li>As a downloadable DVD for local PC installation.</li> </ul>
W@M	<p>W@M Life Cycle Management</p> <p>Improved productivity with information at your fingertips. Data relevant to a plant and its components is generated from the first stages of planning and during the asset's complete life cycle.</p> <p>W@M Life Cycle Management is an open and flexible information platform with online and on-site tools. Instant access for your staff to current, in-depth data shortens your plant's engineering time, speeds up procurement processes and increases plant uptime.</p> <p>Combined with the right services, W@M Life Cycle Management boosts productivity in every phase. For more information, visit <a href="http://www.endress.com/lifecyclemanagement">www.endress.com/lifecyclemanagement</a></p>
FieldCare	<p>FDT-based plant asset management tool from Endress+Hauser. It can configure all smart field units in your system and helps you manage them. By using the status information, it is also a simple but effective way of checking their status and condition.</p> <p> Operating Instructions BA00027S and BA00059S</p>
DeviceCare	<p>Tool to connect and configure Endress+Hauser field devices.</p> <p> Innovation brochure IN01047S</p>

## 15.3 System components

Accessories	Description
Memograph M graphic data manager	<p>The Memograph M graphic data manager provides information on all the relevant measured variables. Measured values are recorded correctly, limit values are monitored and measuring points analyzed. The data are stored in the 256 MB internal memory and also on a SD card or USB stick.</p> <p> <ul style="list-style-type: none"> <li>Technical Information TI00133R</li> <li>Operating Instructions BA00247R</li> </ul> </p>
Cerabar M	<p>The pressure transmitter for measuring the absolute and gauge pressure of gases, steam and liquids. It can be used to read in the operating pressure value.</p> <p> <ul style="list-style-type: none"> <li>Technical Information TI00426P and TI00436P</li> <li>Operating Instructions BA00200P and BA00382P</li> </ul> </p>

Accessories	Description
Cerabar S	<p>The pressure transmitter for measuring the absolute and gauge pressure of gases, steam and liquids. It can be used to read in the operating pressure value.</p> <p> <ul style="list-style-type: none"><li>▪ Technical Information TI00383P</li><li>▪ Operating Instructions BA00271P</li></ul></p>
iTEMP	<p>The temperature transmitters can be used in all applications and are suitable for the measurement of gases, steam and liquids. They can be used to read in the medium temperature.</p> <p> "Fields of Activity" document FA00006T</p>



## 16 Technical data

### 16.1 Application

The measuring device is suitable for flow measurement of liquids and gases only.

Depending on the version ordered, the measuring device can also measure potentially explosive, flammable, poisonous and oxidizing media.

To ensure that the device remains in proper operating condition for its service life, use the measuring device only for media against which the process-wetted materials are sufficiently resistant.

### 16.2 Function and system design

---

Measuring principle	Mass flow measurement based on the Coriolis measuring principle
---------------------	---

---

Measuring system	<p>The device consists of a transmitter and a sensor.</p> <p>The device is available as a compact version: The transmitter and sensor form a mechanical unit.</p> <p>For information on the structure of the device →  15</p>
------------------	--

## 16.3 Input

Measured variable

### Direct measured variables

- Mass flow
- Density
- Temperature

### Calculated measured variables

- Volume flow
- Corrected volume flow
- Reference density

Measuring range

### Measuring range for liquids

DN		Measuring range full scale values $\dot{m}_{\min(F)}$ to $\dot{m}_{\max(F)}$	
[mm]	[in]	[kg/h]	[lb/min]
8	$\frac{3}{8}$	0 to 2 000	0 to 73.50
15	$\frac{1}{2}$	0 to 6 500	0 to 238.9
25	1	0 to 18 000	0 to 661.5
40	$1\frac{1}{2}$	0 to 45 000	0 to 1 654
50	2	0 to 70 000	0 to 2 573
80	3	0 to 180 000	0 to 6 615
100	4	0 to 350 000	0 to 12 860
150	6	0 to 800 000	0 to 29 400
250	10	0 to 2 200 000	0 to 80 850

### Measuring range for gases

The full scale value depends on the density and the sound velocity of the gas used and can be calculated with the formula below:

$$\dot{m}_{\max(G)} = \text{minimum} (\dot{m}_{\max(F)} \cdot \rho_G \cdot x ; \rho_G \cdot c_G \cdot \pi/2 \cdot (d_i)^2 \cdot 3600)$$

$\dot{m}_{\max(G)}$	Maximum full scale value for gas [kg/h]
$\dot{m}_{\max(F)}$	Maximum full scale value for liquid [kg/h]
$\dot{m}_{\max(G)} < \dot{m}_{\max(F)}$	$\dot{m}_{\max(G)}$ can never be greater than $\dot{m}_{\max(F)}$
$\rho_G$	Gas density in [kg/m <sup>3</sup> ] at operating conditions
x	Constant dependent on nominal diameter
$c_G$	Sound velocity (gas) [m/s]
$d_i$	Measuring tube internal diameter [m]

DN		x
[mm]	[in]	[kg/m <sup>3</sup> ]
8	$\frac{3}{8}$	60
15	$\frac{1}{2}$	80
25	1	90
40	$1\frac{1}{2}$	90
50	2	90
80	3	110
100	4	130
150	6	200
250	10	200



### Calculation example for gas

- Sensor: Promass F, DN 50
- Gas: Air with a density of 60.3 kg/m<sup>3</sup> (at 20 °C and 50 bar)
- Measuring range (liquid): 70 000 kg/h
- x = 90 kg/m<sup>3</sup> (for Promass F, DN 50)

Maximum possible full scale value:

$$\dot{m}_{\max(G)} = \dot{m}_{\max(F)} \cdot \rho_G : x = 70\,000 \text{ kg/h} \cdot 60.3 \text{ kg/m}^3 : 90 \text{ kg/m}^3 = 46\,900 \text{ kg/h}$$

### Recommended measuring range

 Flow limit →  205

### Operable flow range

Over 1000 : 1.



Flow rates above the preset full scale value do not override the electronics unit, with the result that the totalizer values are registered correctly.

### Input signal

#### External measured values

To increase the accuracy of certain measured variables or to calculate the corrected volume flow for gases, the automation system can continuously write different measured values to the measuring device:

- Operating pressure to increase accuracy (Endress+Hauser recommends the use of a pressure measuring device for absolute pressure, e.g. Cerabar M or Cerabar S)
- Medium temperature to increase accuracy (e.g. iTEMP)
- Reference density for calculating the corrected volume flow for gases

 Various pressure transmitters and temperature measuring devices can be ordered from Endress+Hauser: see "Accessories" section →  183

It is recommended to read in external measured values to calculate the corrected volume flow.

#### Current input

The measured values are written from the automation system to the measuring device via the current input →  188.

*Digital communication*

The measured values are written from the automation system to the measuring device via Modbus RS485.

**Current input 0/4 to 20 mA**

<b>Current input</b>	0/4 to 20 mA (active/passive)
<b>Current span</b>	<ul style="list-style-type: none"> <li>▪ 4 to 20 mA (active)</li> <li>▪ 0/4 to 20 mA (passive)</li> </ul>
<b>Resolution</b>	1 µA
<b>Voltage drop</b>	Typically: 0.6 to 2 V for 3.6 to 22 mA (passive)
<b>Maximum input voltage</b>	≤ 30 V (passive)
<b>Open-circuit voltage</b>	≤ 28.8 V (active)
<b>Possible input variables</b>	<ul style="list-style-type: none"> <li>▪ Pressure</li> <li>▪ Temperature</li> <li>▪ Density</li> <li>▪</li> </ul>

**Status input**

<b>Maximum input values</b>	<ul style="list-style-type: none"> <li>▪ DC -3 to 30 V</li> <li>▪ If status input is active (ON): <math>R_i &gt; 3 \text{ k}\Omega</math></li> </ul>
<b>Response time</b>	Configurable: 5 to 200 ms
<b>Input signal level</b>	<ul style="list-style-type: none"> <li>▪ Low signal: DC -3 to +5 V</li> <li>▪ High signal: DC 12 to 30 V</li> </ul>
<b>Assignable functions</b>	<ul style="list-style-type: none"> <li>▪ Off</li> <li>▪ Reset the individual totalizers separately</li> <li>▪ Reset all totalizers</li> <li>▪ Flow override</li> </ul>

## 16.4 Output

Output signal

### Modbus RS485

<b>Physical interface</b>	RS485 in accordance with EIA/TIA-485 standard
<b>Terminating resistor</b>	Integrated, can be activated via DIP switches

### Current output 4 to 20 mA

<b>Signal mode</b>	Can be set to: <ul style="list-style-type: none"> <li>■ Active</li> <li>■ Passive</li> </ul>
<b>Current range</b>	Can be set to: <ul style="list-style-type: none"> <li>■ 4 to 20 mA NAMUR</li> <li>■ 4 to 20 mA US</li> <li>■ 4 to 20 mA</li> <li>■ 0 to 20 mA (only with signal mode active)</li> <li>■ Fixed current value</li> </ul>
<b>Maximum output values</b>	22.5 mA
<b>Open-circuit voltage</b>	DC 28.8 V (active)
<b>Maximum input voltage</b>	DC 30 V (passive)
<b>Load</b>	0 to 700 Ω
<b>Resolution</b>	0.38 μA
<b>Damping</b>	Configurable: 0 to 999 s
<b>Assignable measured variables</b>	<ul style="list-style-type: none"> <li>■ Mass flow</li> <li>■ Volume flow</li> <li>■ Corrected volume flow</li> <li>■ Density</li> <li>■ Reference density</li> <li>■ Temperature</li> <li>■ Electronics temperature</li> <li>■ Oscillation frequency 0</li> <li>■ Oscillation damping 0</li> <li>■ Signal asymmetry</li> <li>■ Exciter current 0</li> </ul> <p> The range of options increases if the measuring device has one or more application packages.</p>

### Pulse/frequency/switch output

<b>Function</b>	Can be set to pulse, frequency or switch output
<b>Version</b>	Open collector Can be set to: <ul style="list-style-type: none"> <li>■ Active</li> <li>■ Passive</li> <li>■ Passive NAMUR</li> </ul> <p> Ex-i, passive</p>
<b>Maximum input values</b>	DC 30 V, 250 mA (passive)
<b>Open-circuit voltage</b>	DC 28.8 V (active)

<b>Voltage drop</b>	For 22.5 mA: ≤ DC 2 V
<b>Pulse output</b>	
<b>Maximum input values</b>	DC 30 V, 250 mA (passive)
<b>Maximum output current</b>	22.5 mA (active)
<b>Open-circuit voltage</b>	DC 28.8 V (active)
<b>Pulse width</b>	Configurable: 0.05 to 2 000 ms
<b>Maximum pulse rate</b>	10 000 Impulse/s
<b>Pulse value</b>	Adjustable
<b>Assignable measured variables</b>	<ul style="list-style-type: none"> <li>▪ Mass flow</li> <li>▪ Volume flow</li> <li>▪ Corrected volume flow</li> </ul>
<b>Frequency output</b>	
<b>Maximum input values</b>	DC 30 V, 250 mA (passive)
<b>Maximum output current</b>	22.5 mA (active)
<b>Open-circuit voltage</b>	DC 28.8 V (active)
<b>Output frequency</b>	Adjustable: end value frequency 2 to 10 000 Hz ( $f_{max} = 12\,500$ Hz)
<b>Damping</b>	Configurable: 0 to 999 s
<b>Pulse/pause ratio</b>	1:1
<b>Assignable measured variables</b>	<ul style="list-style-type: none"> <li>▪ Mass flow</li> <li>▪ Volume flow</li> <li>▪ Corrected volume flow</li> <li>▪ Density</li> <li>▪ Reference density</li> <li>▪ Temperature</li> <li>▪ Electronics temperature</li> <li>▪ Oscillation frequency 0</li> <li>▪ Oscillation damping 0</li> <li>▪ Signal asymmetry</li> <li>▪ Exciter current 0</li> </ul> <p> The range of options increases if the measuring device has one or more application packages.</p>
<b>Switch output</b>	
<b>Maximum input values</b>	DC 30 V, 250 mA (passive)
<b>Open-circuit voltage</b>	DC 28.8 V (active)
<b>Switching behavior</b>	Binary, conductive or non-conductive
<b>Switching delay</b>	Configurable: 0 to 100 s

<b>Number of switching cycles</b>	Unlimited
<b>Assignable functions</b>	<ul style="list-style-type: none"> <li>■ Off</li> <li>■ On</li> <li>■ Diagnostic behavior</li> <li>■ Limit value <ul style="list-style-type: none"> <li>■ Mass flow</li> <li>■ Volume flow</li> <li>■ Corrected volume flow</li> </ul> </li> <li>■ Density</li> <li>■ Reference density</li> <li>■ Temperature</li> <li>■ Totalizer 1-3</li> <li>■ Flow direction monitoring</li> <li>■ Status <ul style="list-style-type: none"> <li>■ Partially filled pipe detection</li> <li>■ Low flow cut off</li> </ul> </li> </ul> <p> The range of options increases if the measuring device has one or more application packages.</p>

### Double pulse output

<b>Function</b>	Double pulse
<b>Version</b>	Open collector Can be set to: <ul style="list-style-type: none"> <li>■ Active</li> <li>■ Passive</li> <li>■ Passive NAMUR</li> </ul>
<b>Maximum input values</b>	DC 30 V, 250 mA (passive)
<b>Open-circuit voltage</b>	DC 28.8 V (active)
<b>Voltage drop</b>	For 22.5 mA: ≤ DC 2 V
<b>Output frequency</b>	Configurable: 0 to 1 000 Hz
<b>Damping</b>	Configurable: 0 to 999 s
<b>Pulse/pause ratio</b>	1:1
<b>Assignable measured variables</b>	<ul style="list-style-type: none"> <li>■ Mass flow</li> <li>■ Volume flow</li> <li>■ Corrected volume flow</li> <li>■ Density</li> <li>■ Reference density</li> <li>■ Temperature</li> </ul> <p> The range of options increases if the measuring device has one or more application packages.</p>

### Relay output

<b>Function</b>	Switch output
<b>Version</b>	Relay output, galvanically isolated
<b>Switching behavior</b>	Can be set to: <ul style="list-style-type: none"> <li>■ NO (normally open), factory setting</li> <li>■ NC (normally closed)</li> </ul>

<b>Maximum switching capacity (passive)</b>	<ul style="list-style-type: none"> <li>▪ DC 30 V, 0.1 A</li> <li>▪ AC 30 V, 0.5 A</li> </ul>
<b>Assignable functions</b>	<ul style="list-style-type: none"> <li>▪ Off</li> <li>▪ On</li> <li>▪ Diagnostic behavior</li> <li>▪ Limit value                             <ul style="list-style-type: none"> <li>▪ Mass flow</li> <li>▪ Volume flow</li> <li>▪ Corrected volume flow</li> <li>▪ Density</li> <li>▪ Reference density</li> <li>▪ Temperature</li> <li>▪ Totalizer 1-3</li> </ul> </li> <li>▪ Flow direction monitoring</li> <li>▪ Status                             <ul style="list-style-type: none"> <li>▪ Partially filled pipe detection</li> <li>▪ Low flow cut off</li> </ul> </li> </ul> <p> The range of options increases if the measuring device has one or more application packages.</p>

**User-configurable input/output**

**One** specific input or output is assigned to a user-configurable input/output (configurable I/O) during device commissioning.

The following inputs and outputs are available for assignment:

- Choice of current output: 4 to 20 mA (active), 0/4 to 20 mA (passive)
- Pulse/frequency/switch output
- Choice of current input: 4 to 20 mA (active), 0/4 to 20 mA (passive)
- Status input

Signal on alarm

Depending on the interface, failure information is displayed as follows:

**Modbus RS485**

<b>Failure mode</b>	Choose from: <ul style="list-style-type: none"> <li>▪ NaN value instead of current value</li> <li>▪ Last valid value</li> </ul>
---------------------	---

**Current output 0/4 to 20 mA**

*4 to 20 mA*

<b>Failure mode</b>	Choose from: <ul style="list-style-type: none"> <li>▪ 4 to 20 mA in accordance with NAMUR recommendation NE 43</li> <li>▪ 4 to 20 mA in accordance with US</li> <li>▪ Min. value: 3.59 mA</li> <li>▪ Max. value: 22.5 mA</li> <li>▪ Freely definable value between: 3.59 to 22.5 mA</li> <li>▪ Actual value</li> <li>▪ Last valid value</li> </ul>
---------------------	--

*0 to 20 mA*

<b>Failure mode</b>	Choose from: <ul style="list-style-type: none"> <li>▪ Maximum alarm: 22 mA</li> <li>▪ Freely definable value between: 0 to 20.5 mA</li> </ul>
---------------------	---



**Pulse/frequency/switch output**

Pulse output	
Failure mode	Choose from: <ul style="list-style-type: none"> <li>■ Actual value</li> <li>■ No pulses</li> </ul>
Frequency output	
Failure mode	Choose from: <ul style="list-style-type: none"> <li>■ Actual value</li> <li>■ 0 Hz</li> <li>■ Defined value (<math>f_{max} 2</math> to 12 500 Hz)</li> </ul>
Switch output	
Failure mode	Choose from: <ul style="list-style-type: none"> <li>■ Current status</li> <li>■ Open</li> <li>■ Closed</li> </ul>

**Relay output**

Failure mode	Choose from: <ul style="list-style-type: none"> <li>■ Current status</li> <li>■ Open</li> <li>■ Closed</li> </ul>
--------------	---

**Local display**

Plain text display	With information on cause and remedial measures
Backlight	Red backlighting indicates a device error.

 Status signal as per NAMUR recommendation NE 107

**Interface/protocol**



- Via digital communication:
  - Modbus RS485
- Via service interface
  - CDI-RJ45 service interface
  - WLAN interface

Plain text display	With information on cause and remedial measures
--------------------	---

**Web browser**

Plain text display	With information on cause and remedial measures
--------------------	---



**Light emitting diodes (LED)**

<b>Status information</b>	<p>Status indicated by various light emitting diodes</p> <p>The following information is displayed depending on the device version:</p> <ul style="list-style-type: none"> <li>▪ Supply voltage active</li> <li>▪ Data transmission active</li> <li>▪ Device alarm/error has occurred</li> </ul> <p> Diagnostic information via light emitting diodes →  155</p>
---------------------------	--

Low flow cut off                      The switch points for low flow cut off are user-selectable.

Galvanic isolation                      The outputs are galvanically isolated from one another and from earth (PE).

Protocol-specific data

<b>Protocol</b>	Modbus Applications Protocol Specification V1.1
<b>Response times</b>	<ul style="list-style-type: none"> <li>▪ Direct data access: typically 25 to 50 ms</li> <li>▪ Auto-scan buffer (data range): typically 3 to 5 ms</li> </ul>
<b>Device type</b>	Slave
<b>Slave address range</b>	1 to 247
<b>Broadcast address range</b>	0
<b>Function codes</b>	<ul style="list-style-type: none"> <li>▪ 03: Read holding register</li> <li>▪ 04: Read input register</li> <li>▪ 06: Write single registers</li> <li>▪ 08: Diagnostics</li> <li>▪ 16: Write multiple registers</li> <li>▪ 23: Read/write multiple registers</li> </ul>
<b>Broadcast messages</b>	<p>Supported by the following function codes:</p> <ul style="list-style-type: none"> <li>▪ 06: Write single registers</li> <li>▪ 16: Write multiple registers</li> <li>▪ 23: Read/write multiple registers</li> </ul>
<b>Supported baud rate</b>	<ul style="list-style-type: none"> <li>▪ 1 200 BAUD</li> <li>▪ 2 400 BAUD</li> <li>▪ 4 800 BAUD</li> <li>▪ 9 600 BAUD</li> <li>▪ 19 200 BAUD</li> <li>▪ 38 400 BAUD</li> <li>▪ 57 600 BAUD</li> <li>▪ 115 200 BAUD</li> </ul>
<b>Data transfer mode</b>	<ul style="list-style-type: none"> <li>▪ ASCII</li> <li>▪ RTU</li> </ul>
<b>Data access</b>	<p>Each device parameter can be accessed via Modbus RS485.</p> <p> For Modbus register information</p>
<b>Compatibility with earlier model</b>	<p>If the device is replaced, the measuring device Promass 300 supports the compatibility of the Modbus registers for the process variables and the diagnostic information with the previous model Promass 83. It is not necessary to change the engineering parameters in the automation system.</p>
<b>System integration</b>	<p>Information on system integration →  76.</p> <ul style="list-style-type: none"> <li>▪ Modbus RS485 information</li> <li>▪ Function codes</li> <li>▪ Register information</li> <li>▪ Response time</li> <li>▪ Modbus data map</li> </ul>

## 16.5 Power supply

Terminal assignment →  36

Supply voltage	Order code for "Power supply"		Terminal voltage	Frequency range
	Option D	DC24 V	±20%	–
Option E	AC100 to 240 V	–15...+10%	50/60 Hz	
Option I	DC24 V	±20%	–	
	AC100 to 240 V	–15...+10%	50/60 Hz	

Power consumption

### Transmitter

Max. 10 W (active power)

switch-on current	Max. 36 A (<5 ms) as per NAMUR Recommendation NE 21
-------------------	---

Current consumption

### Transmitter

- Max. 400 mA (24 V)
- Max. 200 mA (110 V, 50/60 Hz; 230 V, 50/60 Hz)

Power supply failure

- Totalizers stop at the last value measured.
- Depending on the device version, the configuration is retained in the device memory or in the pluggable data memory (HistoROM DAT).
- Error messages (incl. total operated hours) are stored.

Electrical connection →  37

Potential equalization →  40

terminals

Spring-loaded terminals: Suitable for strands and strands with ferrules.  
Conductor cross-section 0.2 to 2.5 mm<sup>2</sup> (24 to 12 AWG).

Cable entries



- Cable gland: M20 × 1.5 with cable Ø 6 to 12 mm (0.24 to 0.47 in)
- Thread for cable entry:
  - NPT ½"
  - G ½"
  - M20

Cable specification →  33

## 16.6 Performance characteristics

Reference operating conditions



- Error limits based on ISO 11631
- Water with +15 to +45 °C (+59 to +113 °F) at 2 to 6 bar (29 to 87 psi)
- Specifications as per calibration protocol
- Accuracy based on accredited calibration rigs that are traced to ISO 17025.

 To obtain measured errors, use the *Applicator* sizing tool →  183

Maximum measured error

o.r. = of reading; 1 g/cm<sup>3</sup> = 1 kg/l; T = medium temperature

### Base accuracy

 Design fundamentals →  200

#### *Mass flow and volume flow (liquids)*

±0.05 % o.r. (PremiumCal; order code for "Calibration flow", option D, for mass flow)  
±0.10 % o.r.

#### *Mass flow (cryogenic liquids)*

Order code for "Measuring tube material", option LA  
±0.35 % o.r.

#### *Mass flow (gases)*

±0.35 % o.r.

#### *Density (liquids)*

Under reference operating conditions [g/cm <sup>3</sup> ]	Standard density calibration <sup>1)</sup> [g/cm <sup>3</sup> ]	Wide-range Density specification <sup>2) 3)</sup> [g/cm <sup>3</sup> ]
±0.0005	±0.01	±0.001

- 1) Valid over the entire temperature and density range
- 2) Valid range for special density calibration: 0 to 2 g/cm<sup>3</sup>, +5 to +80 °C (+41 to +176 °F)
- 3) Order code for "Application package", option EE "Special density" only in combination with the order code for "Measuring tube mat., wetted surface", option BB, BF, HA, SA

#### *Density (cryogenic liquids)*

Order code for "Measuring tube material", option LA  
±0.05 g/cm<sup>3</sup>

#### *Temperature*

±0.5 °C ± 0.005 · T °C (±0.9 °F ± 0.003 · (T - 32) °F)

**Zero point stability**

DN		Zero point stability	
[mm]	[in]	[kg/h]	[lb/min]
8	$\frac{3}{8}$	0.030	0.001
15	$\frac{1}{2}$	0.200	0.007
25	1	0.540	0.019
40	$1\frac{1}{2}$	2.25	0.083
50	2	3.50	0.129
80	3	9.0	0.330
100	4	14.0	0.514
150	6	32.0	1.17
250	10	88.0	3.23

High-temperature version: order code for "Measuring tube material", option TS, TT, TU

DN		Zero point stability	
[mm]	[in]	[kg/h]	[lb/min]
15	$\frac{1}{2}$	0.3	0.011
25	1	1.8	0.0662
50	2	7	0.2573
80	3	18	0.6615
100	4	21	0.7718
150	6	48	1.764
250	10	132	4.851

For devices with low-temperature version, order code for "Measuring tube mat., wetted surface", option LA, please note the following:

**NOTICE**

**Zero point confirmation and zero point adjustment are difficult to carry out in the field due to the vaporization of the cryogenic liquid.**

- ▶ As a general rule, the factory-set zero point should not be changed. Please ensure that the medium is in the liquid phase if a zero point adjustment is to be carried out.

**Flow values**

Flow values as turndown parameter depending on nominal diameter.

SI units

DN	1:1	1:10	1:20	1:50	1:100	1:500
	[kg/h]	[kg/h]	[kg/h]	[kg/h]	[kg/h]	[kg/h]
8	2000	200	100	40	20	4
15	6500	650	325	130	65	13
25	18000	1800	900	360	180	36

DN	1:1	1:10	1:20	1:50	1:100	1:500
[mm]	[kg/h]	[kg/h]	[kg/h]	[kg/h]	[kg/h]	[kg/h]
40	45 000	4 500	2 250	900	450	90
50	70 000	7 000	3 500	1 400	700	140
80	180 000	18 000	9 000	3 600	1 800	360
100	350 000	35 000	17 500	7 000	3 500	700
150	800 000	80 000	40 000	16 000	8 000	1 600
250	2 200 000	220 000	110 000	44 000	22 000	4 400

*US units*

DN	1:1	1:10	1:20	1:50	1:100	1:500
[inch]	[lb/min]	[lb/min]	[lb/min]	[lb/min]	[lb/min]	[lb/min]
$\frac{3}{8}$	73.50	7.350	3.675	1.470	0.735	0.147
$\frac{1}{2}$	238.9	23.89	11.95	4.778	2.389	0.478
1	661.5	66.15	33.08	13.23	6.615	1.323
1½	1 654	165.4	82.70	33.08	16.54	3.308
2	2 573	257.3	128.7	51.46	25.73	5.146
3	6 615	661.5	330.8	132.3	66.15	13.23
4	12 860	1 286	643.0	257.2	128.6	25.72
6	29 400	2 940	1 470	588	294	58.80
10	80 850	8 085	4 043	1 617	808.5	161.7

**Accuracy of outputs**

The outputs have the following base accuracy specifications.

*Current output*

<b>Accuracy</b>	±5 µA
-----------------	-------

*Pulse/frequency output*



o.r. = of reading

<b>Accuracy</b>	Max. ±50 ppm o.r. (over the entire ambient temperature range)
-----------------	---

Repeatability

o.r. = of reading; 1 g/cm<sup>3</sup> = 1 kg/l; T = medium temperature

**Base repeatability**

 Design fundamentals →  200

*Mass flow and volume flow (liquids)*

±0.025 % o.r. (PremiumCal, for mass flow)  
 ±0.05 % o.r.

*Mass flow (cryogenic liquids)*

Order code for "Measuring tube material", option LA  
 ±0.175 % o.r.

*Mass flow (gases)*

±0.25 % o.r.

*Density (liquids)*

±0.00025 g/cm<sup>3</sup>

*Density (cryogenic liquids)*

Order code for "Measuring tube material", option LA  
 ±0.025 g/cm<sup>3</sup>

*Temperature*

±0.25 °C ± 0.0025 · T °C (±0.45 °F ± 0.0015 · (T-32) °F)

Response time

The response time depends on the configuration (damping).

Influence of ambient temperature

**Current output**

Temperature coefficient	Max. 1 µA/°C
-------------------------	--------------

**Pulse/frequency output**

Temperature coefficient	No additional effect. Included in accuracy.
-------------------------	---

Influence of medium temperature

**Mass flow and volume flow**

o.f.s. = of full scale value

When there is a difference between the temperature for zero point adjustment and the process temperature, the additional measured error of the sensor is typically ±0.0002 % o.f.s./°C (±0.0001 % o. f.s./°F).

The effect is reduced if zero point adjustment is performed at process temperature.

**Density**

When there is a difference between the density calibration temperature and the process temperature, the typical measured error of the sensor is

±0.00005 g/cm<sup>3</sup> /°C (±0.000025 g/cm<sup>3</sup> /°F). Field density calibration is possible.

**Wide-range density specification (special density calibration)**

If the process temperature is outside the valid range (→ ☰ 196) the measured error is ±0.00005 g/cm<sup>3</sup> /°C (±0.000025 g/cm<sup>3</sup> /°F)

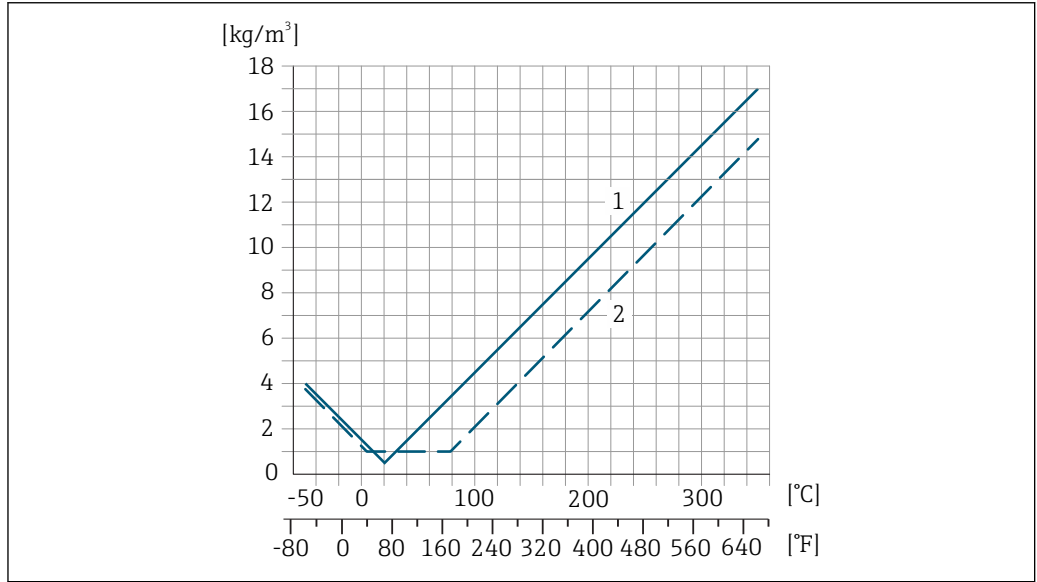

A0027453

- 1 Field density calibration, for example at +20 °C (+68 °F)
- 2 Special density calibration

**Temperature**

$$\pm 0.005 \cdot T \text{ } ^\circ\text{C} (\pm 0.005 \cdot (T - 32) \text{ } ^\circ\text{F})$$

**Influence of medium pressure**

The table below shows the effect on accuracy of mass flow due to a difference between calibration pressure and process pressure.

o.r. = of reading



- It is possible to compensate for the effect by:
  - Reading in the current pressure measured value via the current input.
  - Specifying a fixed value for the pressure in the device parameters.



Operating Instructions.

DN		[% o.r./bar]	[% o.r./psi]
[mm]	[in]		
8	3/8	no influence	
15	1/2	no influence	
25	1	no influence	
40	1 1/2	-0.003	-0.0002
50	2	-0.008	-0.0006
80	3	-0.009	-0.0006
100	4	-0.007	-0.0005
150	6	-0.009	-0.0006
250	10	-0.009	-0.0006

**Design fundamentals**

o.r. = of reading, o.f.s. = of full scale value

BaseAccu = base accuracy in % o.r., BaseRepeat = base repeatability in % o.r.



MeasValue = measured value; ZeroPoint = zero point stability

Calculation of the maximum measured error as a function of the flow rate

Flow rate	Maximum measured error in % o.r.
$\geq \frac{\text{ZeroPoint}}{\text{BaseAccu}} \cdot 100$ <small>A0021332</small>	$\pm \text{BaseAccu}$ <small>A0021339</small>
$< \frac{\text{ZeroPoint}}{\text{BaseAccu}} \cdot 100$ <small>A0021333</small>	$\pm \frac{\text{ZeroPoint}}{\text{MeasValue}} \cdot 100$ <small>A0021334</small>

Calculation of the maximum repeatability as a function of the flow rate

Flow rate	Maximum repeatability in % o.r.
$\geq \frac{1/2 \cdot \text{ZeroPoint}}{\text{BaseRepeat}} \cdot 100$ <small>A0021335</small>	$\pm \text{BaseRepeat}$ <small>A0021340</small>
$< \frac{1/2 \cdot \text{ZeroPoint}}{\text{BaseRepeat}} \cdot 100$ <small>A0021336</small>	$\pm 1/2 \cdot \frac{\text{ZeroPoint}}{\text{MeasValue}} \cdot 100$ <small>A0021337</small>

**Example for maximum measured error**

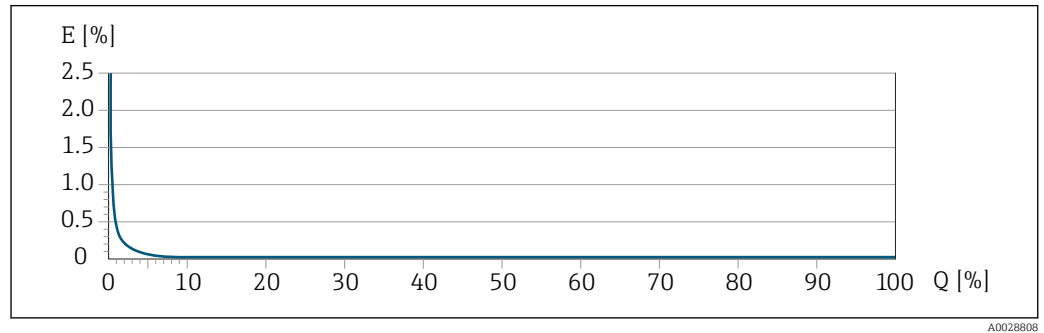

E Maximum measured error in % o.r. (example with PremiumCal)  
 Q Flow rate in % of maximum full scale value

## 16.7 Installation

"Mounting requirements" → 23

## 16.8 Environment

Ambient temperature range

→ 26 → 26

### Temperature tables

Observe the interdependencies between the permitted ambient and fluid temperatures when operating the device in hazardous areas.

For detailed information on the temperature tables, see the separate document entitled "Safety Instructions" (XA) for the device.

Storage temperature -50 to +80 °C (-58 to +176 °F)

Climate class DIN EN 60068-2-38 (test Z/AD)

Degree of protection **Measuring device**

- As standard: IP66/67, type 4X enclosure
- When housing is open: IP20, type 1 enclosure
- Display module: IP20, type 1 enclosure
- With the order code for "Sensor options", option CM: IP69 can also be ordered

**External WLAN antenna**  
IP67

Vibration- and shock-resistance **Vibration broad-band random, according to IEC 60068-2-6**

- 2 to 8.4 Hz, 3.5 mm peak
- 8.4 to 2 000 Hz, 1 g peak

**Vibration broad-band random, according to IEC 60068-2-64**

- 10 to 200 Hz, 0.003 g<sup>2</sup>/Hz
- 200 to 2 000 Hz, 0.001 g<sup>2</sup>/Hz
- Total: 1.54 g rms

**Shock half-sine, according to IEC 60068-2-27**  
6 ms 30 g

**Rough handling shocks, according to IEC 60068-2-31**

Mechanical load Never use the transmitter housing as a ladder or climbing aid.

Electromagnetic compatibility (EMC) As per IEC/EN 61326 and NAMUR Recommendation 21 (NE 21)



Details are provided in the Declaration of Conformity.

## 16.9 Process

Medium temperature range

Standard version	-50 to +150 °C (-58 to +302 °F)	Order code for "Measuring tube mat., wetted surface", option HA, SA, SB, SC
Extended temperature version	-50 to +240 °C (-58 to +464 °F)	Order code for "Measuring tube mat., wetted surface", option SD, SE, SF, TH

High-temperature version	-50 to +350 °C (-58 to +662 °F)	For nominal diameters DN 15 (½"), 25 (1"), 50 to 250 (2 to 10") Order code for "Measuring tube mat., wetted surface", option TS, TT, TU
Low-temperature version	-196 to +150 °C (-320 to +302 °F)  <b>NOTICE</b> <b>Material fatigue due to excessive temperature difference!</b> ▶ Maximum temperature difference of media used: 300 K	Order code for "Measuring tube mat., wetted surface", option LA

**Dependency of ambient temperature on medium temperature**

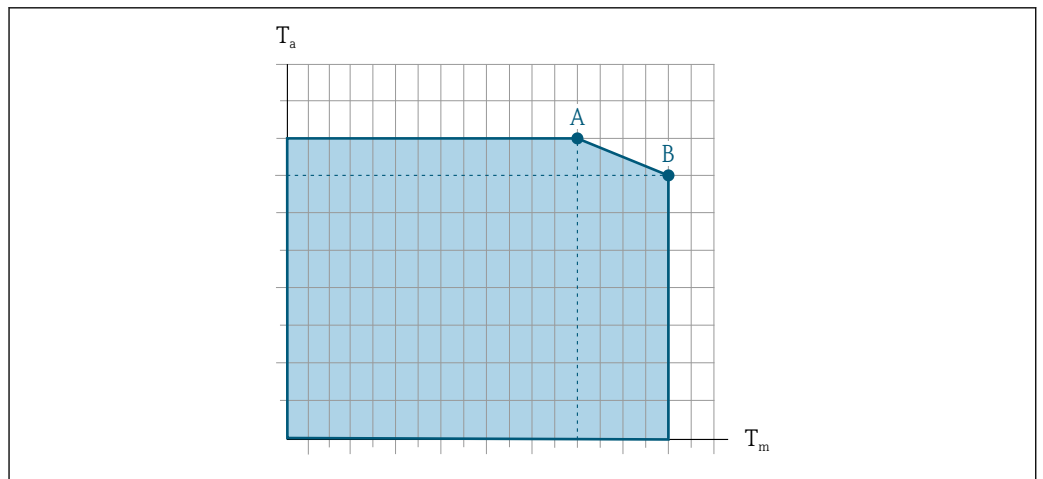

A0031121

30 Exemplary representation, values in the table below.

$T_a$  Ambient temperature range

$T_m$  Medium temperature

A Maximum permitted medium temperature  $T_m$  at  $T_{a,max} = 60\text{ °C}$  (140 °F); higher medium temperatures  $T_m$  require a reduced ambient temperature  $T_a$

B Maximum permitted ambient temperature  $T_a$  for the maximum specified medium temperature  $T_m$  of the sensor

**i** Values for devices used in the hazardous area:  
Separate Ex documentation (XA) for the device → 221.

Version	Not insulated				Insulated			
	A		B		A		B	
	T <sub>a</sub>	T <sub>m</sub>	T <sub>a</sub>	T <sub>m</sub>	T <sub>a</sub>	T <sub>m</sub>	T <sub>a</sub>	T <sub>m</sub>
Standard version	60 °C (140 °F)	150 °C (302 °F)	–	–	60 °C (140 °F)	110 °C (230 °F) <sup>1)</sup>	55 °C (131 °F)	150 °C (302 °F)
Extended temperature version	60 °C (140 °F)	160 °C (320 °F) <sup>2)</sup>	55 °C (131 °F)	240 °C (464 °F)	60 °C (140 °F)	110 °C (230 °F)	50 °C (122 °F) <sup>3)</sup>	240 °C (464 °F)
High-temperature version	60 °C (140 °F)	350 °C (662 °F)	–	–	60 °C (140 °F)	350 °C (662 °F)	–	–

- 1) The maximum permitted medium temperature allowed is, if the sensor is installed in such a way that the transmitter is not mounted above the sensor and free convection can occur on all sides: 150 °C (302 °F)
- 2) The maximum permitted medium temperature allowed is, if the sensor is installed in such a way that the transmitter is not mounted above the sensor and free convection can occur on all sides: 240 °C (464 °F)
- 3) The maximum permitted ambient temperature allowed is, if the sensor is installed in such a way that the transmitter is not mounted above the sensor and free convection can occur on all sides: 55 °C (131 °F)

Density 0 to 5 000 kg/m<sup>3</sup> (0 to 312 lb/cf)

Pressure-temperature ratings  An overview of the pressure-temperature ratings for the process connections is provided in the "Technical Information" document

Sensor housing

For standard versions with the temperature range –50 to +150 °C (–58 to +302 °F), the sensor housing is filled with dry nitrogen gas and protects the electronics and mechanics inside.

For all other temperature versions the sensor housing is filled with dry inert gas.

 If a measuring tube fails (e.g. due to process characteristics like corrosive or abrasive fluids), the fluid will initially be contained by the sensor housing.

In the event of a tube failure, the pressure level inside the sensor housing will rise according to the operating process pressure. If the user judges that the sensor housing pressure rating/burst pressure does not provide an adequate safety margin, the device can be fitted with a rupture disk. This prevents excessively high pressure from forming inside the sensor housing. Therefore, the use of a rupture disk is strongly recommended in applications involving high gas pressures, and particularly in applications in which the process pressure is greater than 2/3 of the sensor housing burst pressure.

If there is a need to drain the leaking medium into a discharge device, the sensor should be fitted with a rupture disk. Connect the discharge to the additional threaded connection .

If the sensor is to be purged with gas (gas detection), it should be equipped with purge connections.

 Do not open the purge connections unless the containment can be filled immediately with a dry, inert gas. Use only low pressure to purge. Maximum pressure: 5 bar (72.5 psi).

**Sensor housing nominal pressure rating and burst pressure**

The following sensor housing nominal pressure ratings/burst pressures are only valid for standard devices and/or devices equipped with closed purge connections (not opened/as delivered).

If a device fitted with purge connections (order code for "Sensor option", option CH "Purge connection") is connected to the purge system, the maximum nominal pressure is determined by the purge system itself or by the device, depending on which component has the lower nominal pressure classification.

If the device is fitted with a rupture disk (order code for "Sensor option", option CA "Rupture disk"), the rupture disk trigger pressure is decisive for the maximum nominal pressure .

The sensor housing burst pressure refers to a typical internal pressure which is reached prior to mechanical failure of the sensor housing and which was determined during type testing. The corresponding type test declaration can be ordered with the device (order code for "Additional approval", option LN "Sensor housing burst pressure, type test").

DN		Sensor housing nominal pressure (designed with a safety factor $\geq 4$ )		Sensor housing burst pressure	
[mm]	[in]	[bar]	[psi]	[bar]	[psi]
8	$\frac{3}{8}$	40	580	255	3 698
15	$\frac{1}{2}$	40	580	200	2 900
25	1	40	580	280	4 060
40	$1\frac{1}{2}$	40	580	180	2 610
50	2	40	580	195	2 828
80	3	25	362	105	1 522
100	4	16	232	85	1 232
150	6	16	232	80	1 160
250	10	10	145	57	826



For information on the dimensions: see the "Mechanical construction" section of the "Technical Information" document

#### Rupture disk

To increase the level of safety, a device version with a rupture disk with a trigger pressure of 10 to 15 bar (145 to 217.5 psi) can be used (order code for "Sensor option", option CA "rupture disk").

The use of rupture disks cannot be combined with the separately available heating jacket.



For information on the dimensions of the rupture disk: see the "Mechanical construction" section of the "Technical Information" document



#### Flow limit

Select the nominal diameter by optimizing between the required flow range and permissible pressure loss.





For an overview of the full scale values for the measuring range, see the "Measuring range" section → 186

- The minimum recommended full scale value is approx. 1/20 of the maximum full scale value
- In most applications, 20 to 50 % of the maximum full scale value can be considered ideal
- A low full scale value must be selected for abrasive media (such as liquids with entrained solids): flow velocity < 1 m/s (< 3 ft/s).
- For gas measurement the following rules apply:
  - The flow velocity in the measuring tubes should not exceed half the sound velocity (0.5 Mach).
  - The maximum mass flow depends on the density of the gas: formula →  186

 To calculate the flow limit, use the *Applicator* sizing tool →  183

Pressure loss

 To calculate the pressure loss, use the *Applicator* sizing tool →  183

Promass F with reduced pressure loss: order code for "Sensor option", option CE "Reduced pressure loss"

System pressure

→  26

## 16.10 Mechanical construction

Design, dimensions

 For the dimensions and installation lengths of the device, see the "Technical Information" document, "Mechanical construction" section.

Weight

All values (weight exclusive of packaging material) refer to devices with EN/DIN PN 40 flanges. Weight specifications including transmitter as per order code for "Housing", option A "Aluminum, coated".

Different values due to different transmitter versions:

- Transmitter version for the hazardous area  
(Order code for "Housing", option A "Aluminum, coated"; Ex d): +2 kg (+4.4 lbs)
- Cast transmitter version, stainless  
(Order code for "Housing", option L "Cast, stainless"): +6 kg (+13 lbs)
- Transmitter version for hygienic area  
(Order code for "Housing", option B "Stainless, hygienic"): +0.2 kg (+0.44 lbs)

### Weight in SI units

DN [mm]	Weight [kg]
8	11
15	12
25	14
40	19
50	30
80	55
100	96

DN [mm]	Weight [kg]
150	154
250	400

### Weight in US units

DN [in]	Weight [lbs]
3/8	24
1/2	26
1	31
1 1/2	42
2	66
3	121
4	212
6	340
10	882

### Materials

#### Transmitter housing

Order code for "Housing":

- Option **A** "Aluminum, coated": aluminum, AlSi10Mg, coated
- Option **B** "Stainless, hygienic": stainless steel, 1.4404 (316L)
- Option **L** "Cast, stainless": cast, stainless steel, 1.4409 (CF3M) similar to 316L

#### Window material

Order code for "Housing":

- Option **A** "Aluminum, coated": glass
- Option **B** "Stainless, hygienic": polycarbonate
- Option **L** "Cast, stainless": glass

#### Seals

Order code for "Housing":

- Option **B** "Stainless, hygienic": EPDM and silicone

**Cable entries/cable glands**

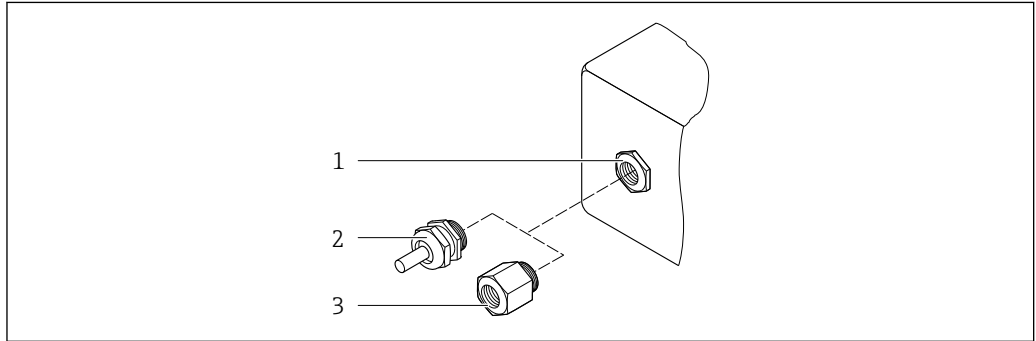

A0020640

31 Possible cable entries/cable glands

- 1 Female thread M20 × 1.5
- 2 Cable gland M20 × 1.5
- 3 Adapter for cable entry with internal thread G ½" or NPT ½"

Order code for "Housing", option A "Aluminum, coated"

The various cable entries are suitable for hazardous and non-hazardous areas.

Cable entry/cable gland	Material
Coupling M20 × 1.5	Non-Ex: plastic
	Z2, D2, Ex d/de: brass with plastic
Adapter for cable entry with internal thread G ½"	Nickel-plated brass
Adapter for cable entry with internal thread NPT ½"	

Order code for "Housing", option B "Stainless, hygienic"

The various cable entries are suitable for hazardous and non-hazardous areas.

Cable entry/cable gland	Material
Cable gland M20 × 1.5	Plastic
Adapter for cable entry with internal thread G ½"	Nickel-plated brass
Adapter for cable entry with internal thread NPT ½"	

Order code for "Housing", option L "Cast, stainless"

The various cable entries are suitable for hazardous and non-hazardous areas.

Cable entry/cable gland	Material
Cable gland M20 × 1.5	Stainless steel, 1.4404 (316L)
Adapter for cable entry with internal thread G ½"	
Adapter for cable entry with internal thread NPT ½"	

**Sensor housing**

**i** The material of the sensor housing depends on the option selected in the order code for "Measuring tube mat., wetted surface".



Order code for "Measuring tube mat., wetted surface"	Material
Option HA, SA, SD, TH	<ul style="list-style-type: none"> <li>■ Acid and alkali-resistant outer surface</li> <li>■ Stainless steel 1.4301 (304)</li> </ul>  With order code for "Sensor option", option <b>CC</b> "316L Sensor housing": stainless steel, 1.4404 (316L)
Option SB, SC, SE, SF	<ul style="list-style-type: none"> <li>■ Acid and alkali-resistant outer surface</li> <li>■ Stainless steel 1.4301 (304)</li> </ul>
Option TS, TT, TU, LA	<ul style="list-style-type: none"> <li>■ Acid and alkali-resistant outer surface</li> <li>■ Stainless steel, 1.4404 (316L)</li> </ul>

### Measuring tubes

- DN 8 to 100 (3/8 to 4"): stainless steel, 1.4539 (904L);  
Manifold: stainless steel, 1.4404 (316/316L)
- DN 150 (6"), DN 250 (10"): stainless steel, 1.4404 (316/316L);  
Manifold: stainless steel, 1.4404 (316/316L)
- DN 8 to 250 (3/8 to 10"): Alloy C22, 2.4602 (UNS N06022);  
Manifold: Alloy C22, 2.4602 (UNS N06022)

#### High-temperature version

DN 15 (1/2"), 25 (1"), 50 to 250 (2 to 10"):

- DN 15 to 100 (1/2 to 4"): stainless steel, 1.4539 (904L)
- DN 150 (6"), 250 (10"): stainless steel, 1.4404 (316/316L)
- DN 15 to 250 (1/2 to 10"): Alloy C22, 2.4602 (UNS N06022)



### Process connections

- Flanges according to EN 1092-1 (DIN2501) / according to ASME B 16.5 / as per JIS B2220:
  - Stainless steel, 1.4404 (F316/F316L)
  - Alloy C22, 2.4602 (UNS N06022)
  - Lap joint flanges: stainless steel, 1.4301 (F304); wetted parts Alloy C22
- All other process connections:  
Stainless steel, 1.4404 (316/316L)

#### High-temperature version

Flanges according to EN 1092-1 (DIN2501) / according to ASME B 16.5 / as per JIS B2220:

- DN 15 to 250 (1/2 to 10"): stainless steel, 1.4404 (316/316L)
- DN 15 to 250 (1/2 to 10"): Alloy C22, 2.4602 (UNS N06022)

 Available process connections →  210

### Seals

Welded process connections without internal seals

### Accessories

#### Protective cover

Stainless steel, 1.4404 (316L)

*External WLAN antenna*

- Antenna: ASA plastic (acrylic ester-styrene-acrylonitrile) and nickel-plated brass
- Adapter: Stainless steel and nickel-plated brass
- Cable: Polyethylene
- Plug: Nickel-plated brass
- Angle bracket: Stainless steel

## Process connections

- Fixed flange connections:
  - EN 1092-1 (DIN 2501) flange
  - EN 1092-1 (DIN 2512N) flange
  - Namur lengths in accordance with NE 132
  - ASME B16.5 flange
  - JIS B2220 flange
  - DIN 11864-2 Form A flange, DIN 11866 series A, flange with notch
- Clamp connections: Tri-Clamp (OD tubes), DIN 11866 series C
- Thread:
  - DIN 11851 thread, DIN 11866 series A
  - SMS 1145 thread
  - ISO 2853 thread, ISO 2037
  - DIN 11864-1 Form A thread, DIN 11866 series A
- VCO connections:
  - 8-VCO-4
  - 12-VCO-4



Process connection materials → 209

## Surface roughness

All data relate to parts in contact with fluid. The following surface roughness quality can be ordered.

- Not polished
- $Ra_{max} = 0.8 \mu\text{m}$  (32  $\mu\text{in}$ )
- $Ra_{max} = 0.4 \mu\text{m}$  (16  $\mu\text{in}$ )

**16.11 Human interface**

## Languages

Can be operated in the following languages:



- Via local operation  
English, German, French, Spanish, Italian, Dutch, Portuguese, Polish, Russian, Turkish, Chinese, Japanese, Korean, Bahasa (Indonesian), Vietnamese, Czech, Swedish
- Via Web browser  
English, German, French, Spanish, Italian, Dutch, Portuguese, Polish, Russian, Turkish, Chinese, Japanese, Korean, Bahasa (Indonesian), Vietnamese, Czech, Swedish
- Via "FieldCare", "DeviceCare" operating tool: English, German, French, Spanish, Italian, Chinese, Japanese

## Local operation

**Via display module**

Equipment:

- Order code for "Display; operation", option F "4-line, illuminated, graphic display; touch control"
- Order code for "Display; operation", option G "4-line, illuminated, graphic display; touch control + WLAN"

 Information about WLAN interface →  71

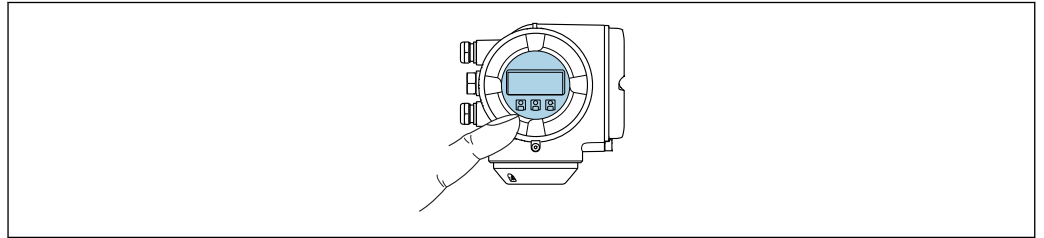



A0026785

 32 *Operation with touch control*



*Display elements*

- 4-line, illuminated, graphic display
- White background lighting; switches to red in event of device errors
- Format for displaying measured variables and status variables can be individually configured
- Permitted ambient temperature for the display:  $-20$  to  $+60$  °C ( $-4$  to  $+140$  °F)  
The readability of the display may be impaired at temperatures outside the temperature range.

*Operating elements*

- External operation via touch control (3 optical keys) without opening the housing: , , 
- Operating elements also accessible in the various zones of the hazardous area

**Via remote display and operating module DKX001**

 The remote display and operating module DKX001 is available as an optional extra →  181.

- The remote display and operating module DKX001 is only available for the following housing versions, order code for "Housing":
  - Option A "Aluminum, coated"
  - Option L "Cast, stainless"
- The measuring device is always supplied with a dummy cover when the remote display and operating module DKX001 is ordered directly with the measuring device. Display or operation at the transmitter is not possible in this case.
- If ordered subsequently, the remote display and operating module DKX001 may not be connected at the same time as the existing measuring device display module. Only one display or operation unit may be connected to the transmitter at any one time.

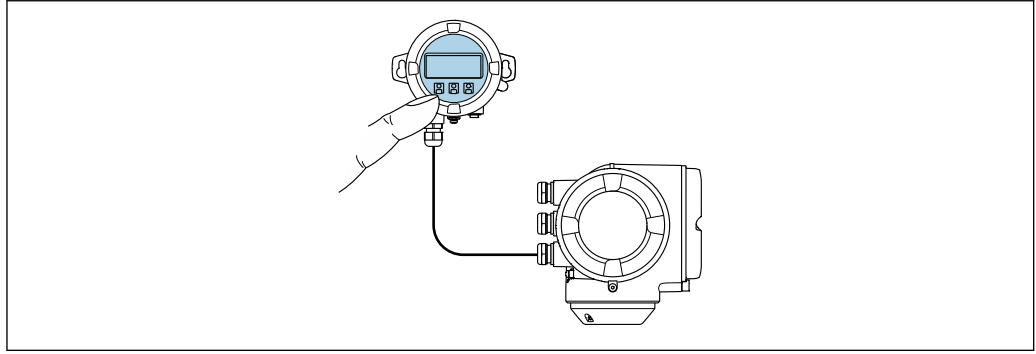

A0026786

33 Operation via remote display and operating module DKX001

*Display and operating elements*

The display and operating elements correspond to those of the display module → 211.

*Material*

The housing material of the display and operating module DKX001 depends on the choice of transmitter housing material.

Transmitter housing		Remote display and operating module
Order code for "Housing"	Material	Material
Option A "Aluminum, coated"	AlSi10Mg, coated	AlSi10Mg, coated
Option L "Cast, stainless"	Cast stainless steel, 1.4409 (CF3M) similar to 316L	1.4409 (CF3M)

*Cable entry*

Corresponds to the choice of transmitter housing, order code for "Electrical connection".

*Connecting cable*

→ 34

*Dimensions*





Information on the dimensions:

"Mechanical construction" section of the "Technical Information" document.

Remote operation → 69

Service interface → 70

Supported operating tools Different operating tools can be used for local or remote access to the measuring device. Depending on the operating tool used, access is possible with different operating units and via a variety of interfaces.

Supported operating tools	Operating unit	Interface	Additional information
Web browser	Notebook, PC or tablet with Web browser	<ul style="list-style-type: none"> <li>▪ CDI-RJ45 service interface</li> <li>▪ WLAN interface</li> </ul>	Special Documentation for device →  221
DeviceCare SFE100	Notebook, PC or tablet with Microsoft Windows system	<ul style="list-style-type: none"> <li>▪ CDI-RJ45 service interface</li> <li>▪ WLAN interface</li> <li>▪ Fieldbus protocol</li> </ul>	→  183
FieldCare SFE500	Notebook, PC or tablet with Microsoft Windows system	<ul style="list-style-type: none"> <li>▪ CDI-RJ45 service interface</li> <li>▪ WLAN interface</li> <li>▪ Fieldbus protocol</li> </ul>	→  183

 Other operating tools based on FDT technology with a device driver such as DTM/iDTM or DD/EDD can be used for device operation. These operating tools are available from the individual manufacturers. Integration into the following operating tools, among others, is supported:

- Field Device Manager (FDM) by Honeywell → [www.honeywellprocess.com](http://www.honeywellprocess.com)
- FieldMate by Yokogawa → [www.yokogawa.com](http://www.yokogawa.com)
- PACTWare → [www.pactware.com](http://www.pactware.com)

The associated device description files are available at: [www.endress.com](http://www.endress.com) → Downloads

### Web server



Thanks to the integrated Web server, the device can be operated and configured via a Web browser and via a service interface (CDI-RJ45) or via a WLAN interface. The structure of the operating menu is the same as for the local display. In addition to the measured values, status information on the device is also displayed and allows the user to monitor the status of the device. Furthermore the device data can be managed and the network parameters can be configured.

A device that has a WLAN interface (can be ordered as an option) is required for the WLAN connection: order code for "Display; operation", option G "4-line, illuminated; touch control + WLAN". The device acts as an Access Point and enables communication by computer or a mobile handheld terminal.

#### Supported functions

Data exchange between the operating unit (such as a notebook for example) and the measuring device:

- Upload the configuration from the measuring device (XML format, configuration backup)
- Save the configuration to the measuring device (XML format, restore configuration)
- Export event list (.csv file)
- Export parameter settings (.csv file or PDF file, document the measuring point configuration)
- Export the Heartbeat verification log (PDF file, only available with the "Heartbeat Verification" application package)
- Flash firmware version for device firmware upgrade, for instance
- Download driver for system integration
- Visualize up to 1000 saved measured values (only available with the **Extended HistoROM** application package →  219)

 Web server special documentation →  221

HistoROM data management

The measuring device features HistoROM data management. HistoROM data management comprises both the storage and import/export of key device and process data, making operation and servicing far more reliable, secure and efficient.

 When the device is delivered, the factory settings of the configuration data are stored as a backup in the device memory. This memory can be overwritten with an updated data record, for example after commissioning.

**Additional information on the data storage concept**

*There are different types of data storage units in which device data are stored and used by the device:*

	Device memory	T-DAT	S-DAT
<b>Available data</b>	<ul style="list-style-type: none"> <li>▪ Event logbook such as diagnostic events for example</li> <li>▪ Parameter data record backup</li> <li>▪ Device firmware package</li> </ul>	<ul style="list-style-type: none"> <li>▪ Measured value logging ("Extended HistoROM" order option)</li> <li>▪ Current parameter data record (used by firmware at run time)</li> <li>▪ Peakhold indicator (min/max values)</li> <li>▪ Totalizer values</li> </ul>	<ul style="list-style-type: none"> <li>▪ Sensor data: nominal diameter etc.</li> <li>▪ Serial number</li> <li>▪ Calibration data</li> <li>▪ Device configuration (e.g. SW options, fixed I/O or multi I/O)</li> </ul>
<b>Storage location</b>	Fixed on the user interface board in the connection compartment	Attachable to the user interface board in the connection compartment	In the sensor plug in the transmitter neck part

**Data backup**

**Automatic**

- The most important device data (sensor and transmitter) are automatically saved in the DAT modules
- If the transmitter or measuring device is replaced: once the T-DAT containing the previous device data has been exchanged, the new measuring device is ready for operation again immediately without any errors
- If the sensor is replaced: once the sensor has been replaced, new sensor data are transferred from the S-DAT in the measuring device and the measuring device is ready for operation again immediately without any errors
- If exchanging the electronics module (e.g. I/O electronics module): Once the electronics module has been replaced, the software of the module is compared against the current device firmware. The module software is upgraded or downgraded where necessary. The electronics module is available for use immediately afterwards and no compatibility problems occur.

**Manual**

Additional parameter data record (complete parameter settings) in the integrated device memory HistoROM backup for:

- Data backup function  
Backup and subsequent restoration of a device configuration in the device memory HistoROM backup
- Data comparison function  
Comparison of the current device configuration with the device configuration saved in the device memory HistoROM backup

**Data transfer**

**Manual**

Transfer of a device configuration to another device using the export function of the specific operating tool, e.g. with FieldCare, DeviceCare or Web server: to duplicate the configuration or to store in an archive (e.g. for backup purposes)

**Event list****Automatic**

- Chronological display of up to 20 event messages in the events list
- If the **Extended HistoROM** application package (order option) is enabled: up to 100 event messages are displayed in the events list along with a time stamp, plain text description and remedial measures
- The events list can be exported and displayed via a variety of interfaces and operating tools e.g. DeviceCare, FieldCare or Web server

**Data logging****Manual**

If the **Extended HistoROM** application package (order option) is enabled:

- Record up to 1 000 measured values via 1 to 4 channels
- User configurable recording interval
- Record up to 250 measured values via each of the 4 memory channels
- Export the measured value log via a variety of interfaces and operating tools e.g. FieldCare, DeviceCare or web server

## 16.12 Certificates and approvals



 Currently available certificates and approvals can be called up via the product configurator.

CE mark	<p>The device meets the legal requirements of the applicable EU Directives. These are listed in the corresponding EU Declaration of Conformity along with the standards applied.</p> <p>Endress+Hauser confirms successful testing of the device by affixing to it the CE mark.</p>
RCM-tick symbol	<p>The measuring system meets the EMC requirements of the "Australian Communications and Media Authority (ACMA)".</p>
Ex approval	<p>The devices are certified for use in hazardous areas and the relevant safety instructions are provided in the separate "Safety Instructions" (XA) document. Reference is made to this document on the nameplate.</p>

Sanitary compatibility	<ul style="list-style-type: none"> <li>■ 3-A approval                             <ul style="list-style-type: none"> <li>■ Only measuring devices with the order code for "Additional approval", option LP "3A" have 3-A approval.</li> <li>■ The 3-A approval refers to the measuring device.</li> <li>■ When installing the measuring device, ensure that no liquid can accumulate on the outside of the measuring device. Remote transmitters must be installed in accordance with the 3-A Standard.</li> <li>■ Accessories (e.g. heating jacket, weather protection cover, wall holder unit) must be installed in accordance with the 3-A Standard. Each accessory can be cleaned. Disassembly may be necessary under certain circumstances.</li> </ul> </li> <li>■ EHEDG-tested Only devices with the order code for "Additional approval", option LT "EHEDG" have been tested and meet the requirements of the EHEDG. To meet the requirements for EHEDG certification, the device must be used with process connections in accordance with the EHEDG position paper entitled "Easy Cleanable Pipe Couplings and Process Connections" (<a href="http://www.ehedg.org">www.ehedg.org</a>).</li> <li>■ FDA</li> <li>■ Food Contact Materials Regulation (EC) 1935/2004</li> </ul>
------------------------	---

Pharmaceutical compatibility	<ul style="list-style-type: none"> <li>■ FDA</li> <li>■ USP Class VI</li> <li>■ TSE/BSE Certificate of Suitability</li> <li>■ cGMP</li> </ul> <p> Devices with the order code "Test, Certificate", option JG "Conformity to cGMP derived requirements, declaration" meet the requirements of cGMP in regards of wetted parts surface finish, design, FDA 21 CFR material compliance, USP Class VI testing, and TSE/BSE compliance.</p> <p>A serial number specific manufacturers declaration is delivered with the device.</p>
------------------------------	---

Pressure Equipment Directive	<ul style="list-style-type: none"> <li>■ With the identification PED/G1/x (x = category) on the sensor nameplate, Endress+Hauser confirms conformity with the "Essential Safety Requirements" specified in Appendix I of the Pressure Equipment Directive 2014/68/EU.</li> <li>■ Devices not bearing this marking (PED) are designed and manufactured according to good engineering practice. They meet the requirements of Article 4 paragraph 3 of the Pressure Equipment Directive 2014/68/EU. The range of application is indicated in tables 6 to 9 in Annex II of the Pressure Equipment Directive 2014/68/EU.</li> </ul>
------------------------------	---

Radio approval	<p>The measuring device has radio approval.</p> <p> For detailed information regarding radio approval, see Special Documentation →  221</p>
----------------	---

Measuring instrument approval	<p>The measuring device is (optionally) approved as a gas meter (MI-002) or component in measuring systems (MI-005) in service subject to legal metrological control in accordance with the European Measuring Instruments Directive 2004/22/EC (MID).</p> <p>The measuring device is qualified to OIML R117 or OIML R137 OIML R117 and has an OIML Certificate of Conformity (optional).</p>
-------------------------------	---



Additional certification

**Marine approval**

Currently valid certificates are available:

- In the Download Area of the Endress+Hauser Internet site: [www.endress.com](http://www.endress.com) → Downloads
- Specify the following details:  
Search area: Approval & Certificates → Marine

**CRN approval**

Some device versions have CRN approval. A CRN-approved process connection with a CSA approval must be ordered for a CRN-approved device.

**Tests and certificates**

- EN10204-3.1 material certificate, parts and sensor housing in contact with medium
- Pressure testing, internal procedure, inspection certificate
- PMI test (XRF), internal procedure, wetted parts, test report
- EN10204-2.1 confirmation of compliance with the order and EN10204-2.2 test report

*Testing of welded connections*

Option	Test standard				Component	
	ISO 23277 AL2x (PT) ISO 10675-1 AL1 (RT, DR)	ASME B31.3 NFS	ASME VIII Div.1 Appx. 4+8	NORSOK M-601	Measuring tube	Process connection
CF	x				PT	RT
KK		x			PT	RT
KP			x		PT	RT
KR				x	VT, PT	VT, RT
K1	x				PT	DR
K2		x			PT	DR
K3			x		PT	DR
K4				x	VT, PT	VT, DR

PT = penetrant testing, RT = radiographic testing, VT = visual testing, DR = digital radiography  
All options with test report

Other standards and guidelines

- EN 60529  
Degrees of protection provided by enclosures (IP code)
- IEC/EN 60068-2-6  
Environmental influences: Test procedure - Test Fc: vibrate (sinusoidal).
- IEC/EN 60068-2-31  
Environmental influences: Test procedure - Test Ec: shocks due to rough handling, primarily for devices.
- EN 61010-1  
Safety requirements for electrical equipment for measurement, control and laboratory use - general requirements
- IEC/EN 61326  
Emission in accordance with Class A requirements. Electromagnetic compatibility (EMC requirements).

- NAMUR NE 21  
Electromagnetic compatibility (EMC) of industrial process and laboratory control equipment
- NAMUR NE 32  
Data retention in the event of a power failure in field and control instruments with microprocessors
- NAMUR NE 43  
Standardization of the signal level for the breakdown information of digital transmitters with analog output signal.
- NAMUR NE 53  
Software of field devices and signal-processing devices with digital electronics
- NAMUR NE 80  
The application of the pressure equipment directive to process control devices
- NAMUR NE 105  
Specifications for integrating fieldbus devices in engineering tools for field devices
- NAMUR NE 107  
Self-monitoring and diagnosis of field devices
- NAMUR NE 131  
Requirements for field devices for standard applications
- NAMUR NE 132  
Coriolis mass meter
- NACE MR0103  
Materials resistant to sulfide stress cracking in corrosive petroleum refining environments.
- NACE MR0175/ISO 15156-1  
Materials for use in H<sub>2</sub>S-containing Environments in Oil and Gas Production.
- ETSI EN 300 328  
Guidelines for 2.4 GHz radio components.
- EN 301489  
Electromagnetic compatibility and radio spectrum matters (ERM).

## 16.13 Application packages

Many different application packages are available to enhance the functionality of the device. Such packages might be needed to address safety aspects or specific application requirements.

The application packages can be ordered with the device or subsequently from Endress+Hauser. Detailed information on the order code in question is available from your local Endress+Hauser sales center or on the product page of the Endress+Hauser website: [www.endress.com](http://www.endress.com).



Detailed information on the application packages:  
Special Documentation for the device →  221

Diagnostics functions	Package	Description
	Extended HistoROM	<p>Comprises extended functions concerning the event log and the activation of the measured value memory.</p> <p>Event log: Memory volume is extended from 20 message entries (standard version) to up to 100 entries.</p> <p>Data logging (line recorder):</p> <ul style="list-style-type: none"> <li>▪ Memory capacity for up to 1000 measured values is activated.</li> <li>▪ 250 measured values can be output via each of the 4 memory channels. The recording interval can be defined and configured by the user.</li> <li>▪ Measured value logs can be accessed via the local display or operating tool e.g. FieldCare, DeviceCare or Web server.</li> </ul>



Heartbeat Technology	Package	Description
	Heartbeat Verification +Monitoring	<p><b>Heartbeat Verification</b> Meets the requirement for traceable verification to DIN ISO 9001:2008 Chapter 7.6 a) "Control of monitoring and measuring equipment".</p> <ul style="list-style-type: none"> <li>▪ Functional testing in the installed state without interrupting the process.</li> <li>▪ Traceable verification results on request, including a report.</li> <li>▪ Simple testing process via local operation or other operating interfaces.</li> <li>▪ Clear measuring point assessment (pass/fail) with high test coverage within the framework of manufacturer specifications.</li> <li>▪ Extension of calibration intervals according to operator's risk assessment.</li> </ul> <p><b>Heartbeat Monitoring</b> Continuously supplies data, which are characteristic of the measuring principle, to an external condition monitoring system for the purpose of preventive maintenance or process analysis. These data enable the operator to:</p> <ul style="list-style-type: none"> <li>▪ Draw conclusions - using these data and other information - about the impact process influences (such as corrosion, abrasion, buildup etc.) have on the measuring performance over time.</li> <li>▪ Schedule servicing in time.</li> <li>▪ Monitor the process or product quality, e.g. gas pockets.</li> </ul>

Concentration	Package	Description
	Concentration	<p><b>Calculation and outputting of fluid concentrations</b></p> <p>The measured density is converted to the concentration of a substance of a binary mixture using the "Concentration" application package:</p> <ul style="list-style-type: none"> <li>▪ Choice of predefined fluids (e.g. various sugar solutions, acids, alkalis, salts, ethanol etc.)</li> <li>▪ Common or user-defined units (°Brix, °Plato, % mass, % volume, mol/l etc.) for standard applications.</li> <li>▪ Concentration calculation from user-defined tables.</li> </ul>

Special density	Package	Description
	Special density	<p>Many applications use density as a key measured value for monitoring quality or controlling processes. The device measures the density of the fluid as standard and makes this value available to the control system.</p> <p>The "Special Density" application package offers high-precision density measurement over a wide density and temperature range particularly for applications subject to varying process conditions.</p>

Petroleum	Package	Description
	Petroleum	The most important parameters for the Oil & Gas Industry can be calculated and displayed with this application package. <ul style="list-style-type: none"> <li>▪ Corrected volume flow and calculated reference density in accordance with the "API Manual of Petroleum Measurement Standards, Chapter 11.1"</li> <li>▪ Water content, based on density measurement</li> <li>▪ Weighted mean of the density and temperature</li> </ul>

## 16.14 Accessories

 Overview of accessories available for order →  181

## 16.15 Supplementary documentation

-  For an overview of the scope of the associated Technical Documentation, refer to the following:
- *W@M Device Viewer* ([www.endress.com/deviceviewer](http://www.endress.com/deviceviewer)): Enter the serial number from nameplate
  - *Endress+Hauser Operations App*: Enter the serial number from the nameplate or scan the 2D matrix code (QR code) on the nameplate

### Standard documentation **Brief Operating Instructions**

*Brief Operating Instructions for the sensor*

Measuring device	Documentation code
Proline Promass F	KA013570

*Brief Operating Instructions for transmitter*

Measuring device	Documentation code
Proline 300	KA013650

### Technical Information

Measuring device	Documentation code
Promass F 300	TI013200

### Description of Device Parameters

Measuring device	Documentation code
Promass 300	GP011060

Device-dependent  
additional documentation

### Safety instructions

Safety instructions for electrical equipment for hazardous areas.

Contents	Documentation code
ATEX/IECEX Ex d/Ex de	XA01405D
ATEX/IECEX Ex ec	XA01439D
cCSAus XP	XA01373D
cCSAus Ex d/ Ex de	XA01372D
cCSAus Ex nA	XA01507D
INMETRO Ex d/Ex de	XA01468D
INMETRO Ex ec	XA01470D
NEPSI Ex d/Ex de	XA01469D
NEPSI Ex nA	XA01471D
EAC Ex d/Ex de	XA01656D
EAC Ex nA	XA01657D
JPN Ex d	XA01778D

### Remote display and operating module DKX001

Contents	Documentation code
ATEX/IECEX Ex i	XA01494D
ATEX/IECEX Ex ec	XA01498D
cCSAus IS	XA01499D
cCSAus Ex nA	XA01513D
INMETRO Ex i	XA01500D
INMETRO Ex ec	XA01501D
NEPSI Ex i	XA01502D
NEPSI Ex nA	XA01503D

### Special Documentation

Contents	Documentation code
Information on the Pressure Equipment Directive	SD01614D
Remote display and operating module DKX001	SD01763D
Radio approvals for WLAN interface for A309/A310 display module	SD01793D
Web server	SD019110
Heartbeat Technology	SD019070
Concentration measurement	SD019090
Petroleum	SD021310
Custody transfer	SD01689D

### Installation Instructions

Content	Comment
Installation instructions for spare part sets and accessories	<ul style="list-style-type: none"><li data-bbox="764 317 1443 369">▪ Access the overview of all the available spare part sets via <i>W@M Device Viewer</i> → 📄 179</li><li data-bbox="764 369 1443 403">▪ Accessories available for order with Installation Instructions → 📄 181</li></ul>

# Index

## 0 ... 9

3-A approval . . . . . 216

## A

About this document . . . . . 6

Access authorization to parameters

    Read access . . . . . 61

    Write access . . . . . 61

Access code . . . . . 61

    Incorrect input . . . . . 61

Accuracy . . . . . 196

Adapting the diagnostic behavior . . . . . 163

Additional certification . . . . . 217

Ambient temperature

    Influence . . . . . 199

Application . . . . . 185

Application packages . . . . . 218

Applicator . . . . . 186

Approvals . . . . . 215

Auto scan buffer

    see Modbus RS485 Modbus data map

## C

Cable entries

    Technical data . . . . . 195

Cable entry

    Degree of protection . . . . . 46

CE mark . . . . . 12, 215

Certificates . . . . . 215

cGMP . . . . . 216

Check

    Installation . . . . . 32

Checklist

    Post-connection check . . . . . 46

    Post-installation check . . . . . 32

Cleaning

    Cleaning in place (CIP) . . . . . 178

    Exterior cleaning . . . . . 178

    Interior cleaning . . . . . 178

    Sterilization in place (SIP) . . . . . 178

Climate class . . . . . 202

Commissioning . . . . . 81

    Advanced settings . . . . . 116

    Configuring the measuring device . . . . . 81

Compatibility . . . . . 177

Configuring error response mode, Modbus RS485 . . . . . 162

Connecting cable . . . . . 33, 34

Connecting the measuring device . . . . . 37

Connecting the signal cables . . . . . 37

Connecting the supply voltage cables . . . . . 37

Connection

    see Electrical connection

Connection preparations . . . . . 36

Connection tools . . . . . 33

Context menu

    Calling up . . . . . 58

    Closing . . . . . 58

    Explanation . . . . . 58

Current consumption . . . . . 195

## D

Declaration of Conformity . . . . . 12

Define access code . . . . . 136, 137

Degree of protection . . . . . 46, 202

Density . . . . . 204

Design fundamentals

    Maximum measured error . . . . . 200

    Repeatability . . . . . 200

Designated use . . . . . 10

Device components . . . . . 15

Device description files . . . . . 75

Device documentation

    Supplementary documentation . . . . . 9

Device history . . . . . 177

Device locking, status . . . . . 139

Device name

    Sensor . . . . . 19

    Transmitter . . . . . 18

Device repair . . . . . 179

Device revision . . . . . 75

Device type ID . . . . . 75

DeviceCare . . . . . 73

    Device description file . . . . . 75

Diagnostic behavior

    Explanation . . . . . 158

    Symbols . . . . . 158

Diagnostic information

    Communication interface . . . . . 162

    Design, description . . . . . 158, 161

    DeviceCare . . . . . 161

    FieldCare . . . . . 161

    Light emitting diodes . . . . . 155

    Local display . . . . . 157

    Overview . . . . . 163

    Remedial measures . . . . . 163

    Web browser . . . . . 160

Diagnostic list . . . . . 169

Diagnostic message . . . . . 157

Diagnostics

    Symbols . . . . . 157

DIP switches

    see Write protection switch

Direct access . . . . . 60

Direct access code . . . . . 54

- Disabling write protection . . . . . 136
- Display
  - see Onsite display
- Display and operating module DKX001 . . . . . 211
- Display area
  - For operational display . . . . . 52
  - In the navigation view . . . . . 54
- Display values
  - For locking status . . . . . 139
- Disposal . . . . . 180
- Document
  - Function . . . . . 6
  - Symbols . . . . . 6
- Document function . . . . . 6
- Down pipe . . . . . 23
- E**
- Editing view . . . . . 55
  - Input screen . . . . . 56
  - Using operating elements . . . . . 56, 57
- EHDEG-certified . . . . . 216
- Electrical connection
  - Computer with Web browser (e.g. Internet Explorer) . . . . . 69
  - Degree of protection . . . . . 46
  - Measuring device . . . . . 33
  - Operating tool (e.g. FieldCare, DeviceCare, AMS Device Manager, SIMATIC PDM) . . . . . 69
  - Operating tools
    - Via Modbus RS485 protocol . . . . . 69
    - Via service interface (CDI-RJ45) . . . . . 70
    - Via WLAN interface . . . . . 71
  - Web server . . . . . 70
  - WLAN interface . . . . . 71
- Electromagnetic compatibility . . . . . 202
- Electronics module . . . . . 15
- Enabling write protection . . . . . 136
- Enabling/disabling the keypad lock . . . . . 62
- Endress+Hauser services
  - Maintenance . . . . . 178
  - Repair . . . . . 179
- Environment
  - Mechanical load . . . . . 202
  - Storage temperature . . . . . 202
  - Vibration- and shock-resistance . . . . . 202
- Error messages
  - see Diagnostic messages
- Event list . . . . . 170
- Event logbook . . . . . 170
- Ex approval . . . . . 215
- Extended order code
  - Sensor . . . . . 19
  - Transmitter . . . . . 18
- Exterior cleaning . . . . . 178
- F**
- FDA . . . . . 216
- Field of application
  - Residual risks . . . . . 11
- FieldCare . . . . . 72
  - Device description file . . . . . 75
  - Establishing a connection . . . . . 73
  - Function . . . . . 72
  - User interface . . . . . 73
- Filtering the event logbook . . . . . 170
- Firmware
  - Release date . . . . . 75
  - Version . . . . . 75
- Firmware history . . . . . 175
- Flow direction . . . . . 24, 30
- Flow limit . . . . . 205
- Food Contact Materials Regulation . . . . . 216
- Function check . . . . . 81
- Function codes . . . . . 76
- Functions
  - see Parameter
- G**
- Galvanic isolation . . . . . 194
- H**
- Hardware write protection . . . . . 137
- Help text
  - Calling up . . . . . 60
  - Closing . . . . . 60
  - Explanation . . . . . 60
- HistoROM . . . . . 129
- I**
- Identifying the measuring device . . . . . 17
- Incoming acceptance . . . . . 16
- Influence
  - Ambient temperature . . . . . 199
  - Medium pressure . . . . . 200
  - Medium temperature . . . . . 199
- Inlet runs . . . . . 25
- Input . . . . . 186
- Inspection
  - Received goods . . . . . 16
- Inspection check
  - Connection . . . . . 46
- Installation . . . . . 23
- Installation conditions
  - Down pipe . . . . . 23
  - Inlet and outlet runs . . . . . 25
  - Installation dimensions . . . . . 25
  - Mounting location . . . . . 23
  - Orientation . . . . . 24
  - Rupture disk . . . . . 28
  - Sensor heating . . . . . 27



- System pressure . . . . . 26
- Thermal insulation . . . . . 26
- Vibrations . . . . . 28
- Installation dimensions . . . . . 25
- Interior cleaning . . . . . 178
- L**
- Languages, operation options . . . . . 210
- Line recorder . . . . . 148
- Local display . . . . . 211
  - Navigation view . . . . . 53
  - see Diagnostic message
  - see In alarm condition
  - see Operational display
- Low flow cut off . . . . . 194
- M**
- Main electronics module . . . . . 15
- Maintenance tasks . . . . . 178
- Managing the device configuration . . . . . 129
- Manufacturer ID . . . . . 75
- Manufacturing date . . . . . 18, 19
- Materials . . . . . 207
- Maximum measured error . . . . . 196
- Measured values
  - see Process variables
- Measuring and test equipment . . . . . 178
- Measuring device
  - Configuration . . . . . 81
  - Conversion . . . . . 179
  - Disposal . . . . . 180
  - Mounting the sensor . . . . . 30
  - Preparing for electrical connection . . . . . 36
  - Preparing for mounting . . . . . 30
  - Removing . . . . . 180
  - Repairs . . . . . 179
  - Structure . . . . . 15
- Measuring instrument approval . . . . . 216
- Measuring principle . . . . . 185
- Measuring range
  - Calculation example for gas . . . . . 187
  - For gases . . . . . 186
  - For liquids . . . . . 186
- Measuring range, recommended . . . . . 205
- Measuring system . . . . . 185
- Mechanical load . . . . . 202
- Medium pressure
  - Influence . . . . . 200
- Medium temperature
  - Influence . . . . . 199
- Menu
  - Diagnostics . . . . . 168
  - Setup . . . . . 83
- Menus
  - For measuring device configuration . . . . . 81
  - For specific settings . . . . . 116
- Modbus RS485
  - Configuring error response mode . . . . . 162
  - Diagnostic information . . . . . 162
  - Function codes . . . . . 76
  - Modbus data map . . . . . 79
  - Read access . . . . . 76
  - Reading out data . . . . . 80
  - Register addresses . . . . . 77
  - Register information . . . . . 77
  - Response time . . . . . 77
  - Scan list . . . . . 79
  - Write access . . . . . 76
- Mounting dimensions
  - see Installation dimensions
- Mounting location . . . . . 23
- Mounting preparations . . . . . 30
- Mounting tools . . . . . 30
- N**
- Nameplate
  - Sensor . . . . . 19
  - Transmitter . . . . . 18
- Navigation path (navigation view) . . . . . 53
- Navigation view
  - In the submenu . . . . . 53
  - In the wizard . . . . . 53
- Numeric editor . . . . . 55
- O**
- Onsite display
  - Numeric editor . . . . . 55
  - Text editor . . . . . 56
- Operable flow range . . . . . 187
- Operating elements . . . . . 57, 158
- Operating keys
  - see Operating elements
- Operating menu
  - Menus, submenus . . . . . 48
  - Structure . . . . . 48
  - Submenus and user roles . . . . . 50
- Operating philosophy . . . . . 50
- Operation . . . . . 139
- Operation options . . . . . 47
- Operational display . . . . . 51
- Operational safety . . . . . 11
- Order code . . . . . 18, 19
- Orientation (vertical, horizontal) . . . . . 24
- Outlet runs . . . . . 25
- Output . . . . . 189
- Output signal . . . . . 189
- P**
- Packaging disposal . . . . . 22

- Parameter
    - Changing . . . . . 61
    - Entering values or text . . . . . 61
  - Parameter settings
    - Administration (Submenu) . . . . . 132
    - Advanced setup (Submenu) . . . . . 117
    - Calculated values (Submenu) . . . . . 117
    - Communication (Submenu) . . . . . 85
    - Configuration backup (Submenu) . . . . . 129
    - Current input . . . . . 89
    - Current input (Wizard) . . . . . 89
    - Current input 1 to n (Submenu) . . . . . 143
    - Current output . . . . . 92
    - Current output (Wizard) . . . . . 92
    - Data logging (Submenu) . . . . . 148
    - Define access code (Wizard) . . . . . 131
    - Device information (Submenu) . . . . . 173
    - Diagnostics (Menu) . . . . . 168
    - Display (Submenu) . . . . . 122
    - Display (Wizard) . . . . . 109
    - Double pulse output . . . . . 108
    - Double pulse output (Submenu) . . . . . 108, 146
    - I/O configuration . . . . . 89
    - I/O configuration (Submenu) . . . . . 89
    - Low flow cut off (Wizard) . . . . . 114
    - Measured variables (Submenu) . . . . . 140
    - Partially filled pipe detection (Wizard) . . . . . 115
    - Pulse/frequency/switch output . . . . . 96
    - Pulse/frequency/switch output (Wizard) 96, 98, 102
    - Pulse/frequency/switch output 1 to n (Submenu) 145
    - Relay output . . . . . 105
    - Relay output 1 to n (Submenu) . . . . . 145
    - Relay output 1 to n (Wizard) . . . . . 105
    - Reset access code (Submenu) . . . . . 131
    - Select medium (Wizard) . . . . . 87
    - Sensor adjustment (Submenu) . . . . . 118
    - Setup (Menu) . . . . . 83
    - Simulation (Submenu) . . . . . 132
    - Status input . . . . . 91
    - Status input (Submenu) . . . . . 91
    - Status input 1 to n (Submenu) . . . . . 143
    - System units (Submenu) . . . . . 83
    - Totalizer (Submenu) . . . . . 142
    - Totalizer 1 to n (Submenu) . . . . . 119
    - Totalizer handling (Submenu) . . . . . 146
    - Value current output 1 to n (Submenu) . . . . . 144
    - Web server (Submenu) . . . . . 68
    - WLAN Settings (Submenu) . . . . . 127
    - Zero point adjustment (Submenu) . . . . . 119
  - Performance characteristics . . . . . 196
  - Pharmaceutical compatibility . . . . . 216
  - Post-connection check (checklist) . . . . . 46
  - Post-installation check . . . . . 81
  - Post-installation check (checklist) . . . . . 32
  - Potential equalization . . . . . 40
  - Power consumption . . . . . 195
  - Power supply failure . . . . . 195
  - Pressure Equipment Directive . . . . . 216
  - Pressure loss . . . . . 206
  - Pressure-temperature ratings . . . . . 204
  - Process connections . . . . . 210
  - Process variables
    - Calculated . . . . . 186
    - Measured . . . . . 186
  - Product safety . . . . . 12
  - Protecting parameter settings . . . . . 136
- R**
- Radio approval . . . . . 216
  - RCM-tick symbol . . . . . 215
  - Read access . . . . . 61
  - Reading measured values . . . . . 139
  - Reading out diagnostic information, Modbus RS485 162
  - Recalibration . . . . . 178
  - Reference operating conditions . . . . . 196
  - Registered trademarks . . . . . 9
  - Remedial measures
    - Calling up . . . . . 159
    - Closing . . . . . 159
  - Remote operation . . . . . 212
  - Repair . . . . . 179
  - Repair of a device . . . . . 179
  - Repairs
    - Notes . . . . . 179
  - Repeatability . . . . . 198
  - Replacement
    - Device components . . . . . 179
  - Requirements for personnel . . . . . 10
  - Response time . . . . . 199
  - Return . . . . . 179
  - Rupture disk
    - Safety instructions . . . . . 28
    - Triggering pressure . . . . . 205
- S**
- Safety . . . . . 10
  - Sanitary compatibility . . . . . 216
  - Sensor
    - Mounting . . . . . 30
  - Sensor heating . . . . . 27
  - Sensor housing . . . . . 204
  - Serial number . . . . . 18, 19
  - Setting the operating language . . . . . 81
  - Settings
    - Adapting the measuring device to the process conditions . . . . . 146
    - Administration . . . . . 130
    - Advanced display configurations . . . . . 122
    - Communication interface . . . . . 85
    - Current input . . . . . 89

- Current output . . . . . 92
- Device reset . . . . . 172
- Double pulse output . . . . . 108
- I/O configuration . . . . . 89
- Local display . . . . . 109
- Low flow cut off . . . . . 114
- Managing the device configuration . . . . . 129
- Medium . . . . . 87
- Operating language . . . . . 81
- Partial filled pipe detection . . . . . 115
- Pulse output . . . . . 96
- Pulse/frequency/switch output . . . . . 96, 98
- Relay output . . . . . 105
- Resetting the totalizer . . . . . 146
- Sensor adjustment . . . . . 118
- Simulation . . . . . 132
- Status input . . . . . 91
- Switch output . . . . . 102
- System units . . . . . 83
- Tag name . . . . . 83
- Totalizer . . . . . 119
- Totalizer reset . . . . . 146
- WLAN . . . . . 127
- Showing data logging . . . . . 148
- Signal on alarm . . . . . 192
- Software release . . . . . 75
- Spare part . . . . . 179
- Spare parts . . . . . 179
- Special connection instructions . . . . . 41
- Special mounting instructions
  - Sanitary compatibility . . . . . 28
- Standards and guidelines . . . . . 217
- Status area
  - For operational display . . . . . 52
  - In the navigation view . . . . . 54
- Status signals . . . . . 157, 160
- Storage concept . . . . . 214
- Storage conditions . . . . . 21
- Storage temperature . . . . . 21
- Storage temperature range . . . . . 202
- Structure
  - Measuring device . . . . . 15
  - Operating menu . . . . . 48
- Submenu
  - Administration . . . . . 130, 132
  - Advanced setup . . . . . 116, 117
  - Calculated values . . . . . 117
  - Communication . . . . . 85
  - Configuration backup . . . . . 129
  - Current input 1 to n . . . . . 143
  - Data logging . . . . . 148
  - Device information . . . . . 173
  - Display . . . . . 122
  - Double pulse output . . . . . 108, 146
  - Event list . . . . . 170
  - I/O configuration . . . . . 89
  - Input values . . . . . 142
  - Measured values . . . . . 139
  - Measured variables . . . . . 140
  - Output values . . . . . 144
  - Overview . . . . . 50
  - Process variables . . . . . 117
  - Pulse/frequency/switch output 1 to n . . . . . 145
  - Relay output 1 to n . . . . . 145
  - Reset access code . . . . . 131
  - Sensor adjustment . . . . . 118
  - Simulation . . . . . 132
  - Status input . . . . . 91
  - Status input 1 to n . . . . . 143
  - System units . . . . . 83
  - Totalizer . . . . . 142
  - Totalizer 1 to n . . . . . 119
  - Totalizer handling . . . . . 146
  - Value current output 1 to n . . . . . 144
  - Web server . . . . . 68
  - WLAN Settings . . . . . 127
  - Zero point adjustment . . . . . 119
- Supply voltage . . . . . 195
- Surface roughness . . . . . 210
- Switch output . . . . . 191
- Symbols
  - Controlling data entries . . . . . 57
  - For communication . . . . . 52
  - For diagnostic behavior . . . . . 52
  - For locking . . . . . 52
  - For measured variable . . . . . 52
  - For measurement channel number . . . . . 52
  - For menus . . . . . 54
  - For parameters . . . . . 54
  - For status signal . . . . . 52
  - For submenu . . . . . 54
  - For wizard . . . . . 54
  - In the status area of the local display . . . . . 52
  - Input screen . . . . . 56
  - Operating elements . . . . . 56
- System design
  - Measuring system . . . . . 185
  - see Measuring device design
- System integration . . . . . 75
- System pressure . . . . . 26
- T**
  - Technical data, overview . . . . . 185
  - Temperature range
    - Ambient temperature range for display . . . . . 211
    - Medium temperature . . . . . 202
    - Storage temperature . . . . . 21
  - Terminal assignment . . . . . 36
  - terminals . . . . . 195
  - Tests and certificates . . . . . 217

- Text editor . . . . . 56
  - Thermal insulation . . . . . 26
  - Tool tip
    - see Help text
  - Tools
    - Electrical connection . . . . . 33
    - For mounting . . . . . 30
    - Transport . . . . . 21
  - Totalizer
    - Configuration . . . . . 119
  - Transmitter
    - Turning the display module . . . . . 31
    - Turning the housing . . . . . 31
  - Transporting the measuring device . . . . . 21
  - Troubleshooting
    - General . . . . . 153
  - TSE/BSE Certificate of Suitability . . . . . 216
  - Turning the display module . . . . . 31
  - Turning the electronics housing
    - see Turning the transmitter housing
  - Turning the transmitter housing . . . . . 31
- U**
- Use of the measuring device
    - Borderline cases . . . . . 10
    - Incorrect use . . . . . 10
    - see Designated use
  - User interface
    - Current diagnostic event . . . . . 168
    - Previous diagnostic event . . . . . 168
  - User roles . . . . . 50
  - USP Class VI . . . . . 216
- V**
- Version data for the device . . . . . 75
  - Vibration- and shock-resistance . . . . . 202
  - Vibrations . . . . . 28
- W**
- W@M . . . . . 178, 179
  - W@M Device Viewer . . . . . 17, 179
  - Weight
    - SI units . . . . . 206
    - Transport (notes) . . . . . 21
    - US units . . . . . 207
  - Wizard
    - Current input . . . . . 89
    - Current output . . . . . 92
    - Define access code . . . . . 131
    - Display . . . . . 109
    - Low flow cut off . . . . . 114
    - Partially filled pipe detection . . . . . 115
    - Pulse/frequency/switch output . . . . . 96, 98, 102
    - Relay output 1 to n . . . . . 105
    - Select medium . . . . . 87
  - WLAN settings . . . . . 127
  - Workplace safety . . . . . 11
  - Write access . . . . . 61
  - Write protection
    - Via access code . . . . . 136
    - Via write protection switch . . . . . 137
  - Write protection switch . . . . . 137



The specifications contained herein are subject to change without notice and any user of said specifications should verify from the manufacturer that the specifications are currently in effect. Otherwise, the manufacturer assumes no responsibility for the use of specifications which may have been changed and are no longer in effect.

**TechnipFMC.com**

© 2019 TechnipFMC plc. All rights reserved. BA01668O/06/EN/04.19

TechnipFMC  
Measurement Solutions, Inc.  
13460 Lockwood Road  
Building S01  
Houston, Texas 77044 USA  
P:+1 281.591.4000

USA Operation  
1602 Wagner Avenue  
Erie, Pennsylvania 16510 USA  
P:+1 814.898.5000

Germany Operation  
Smith Meter GmbH  
Regentstrasse 1  
25474 Ellerbek, Germany  
P:+49 4101 304.0