



R **A** **N** **G** **E** **R**

VALVE AMERICA

**API 6D TRUNNION MOUNTED
BALL VALVE**

ASME CLASS 150 - 2500#



CONTENTS

VALVE FEATURES	4
SEAT DESIGNS	6-7
PRODUCT RANGE API 6D FP AND RP	8
DESIGN AND TEST STANDARDS	8
CROSS SECTIONAL DRAWING & BOM	9-10
SIZES, DIMENSIONS & WEIGHTS	11-14
TOP WORKS	15-17
TORQUE VALUES	18
CV VALUES	19
PRESSURE & TEMPERATURE CHART FOR TYPICAL SEAT & SEAL MATERIALS	20
PART NUMBER CONFIGURATION	21



RANGER

VALVE AMERICA

Ranger Valve America Ltd. (Ranger™) is a specialized supplier of API 6D, API 600, API 6A and API 16C valves and flow control components, including industrial valves and wellhead equipment.

Ranger™ works closely with its partners and strives to exceed expectations.

Ranger™ works to provide a rigorous research and development program aimed at product design, innovation and validation. Ranger™ uses a full spectrum of inspection and test equipment to ensure that all products meet or exceed the quality standards, including:

- Mechanical: tensile, impact and hardness testing;
- NDE: PT, MT, UT
- Chemical: PMI
- Fugitive emission
- Shell type acceptance test(TAT).

As well, Ranger™ simulates various tests in critical and crucial working conditions to verify product performance.

FEATURES

The Ranger™ series of forged and cast trunnion ball valves have been engineered to meet both general and severe service applications and are appropriate for use in industries including petroleum, refining, transmission/pipeline, petro-chemical, and others. Ranger™ valves are designed in accordance with API 6D and CSA Z245.15, they are available in a variety of configurations and materials to meet your specific operational needs. Combined with our industry leading 48/24 month extended warranty, Ranger™ valves not only meet but exceed industry standards.

FEATURES

- Valve body, closures, ball and seat carriers are manufactured from forged steel to ensure high strength, dependable service life in high pressure or severe applications.
- Available seat configurations include self-relieving (single piston effect), DIB-1 (double piston effect) and DIB-2 (single piston one side, double piston one side) options.
- DIB-1 valves are provided with drilled, tapped, plugged ports for ease of thermal relief piping as necessary.
 - The primary seat design utilizes TEFLON, DEVLON or PEEK as standard dependent upon pressure class, the secondary metal seat ring will provide sealing should the primary be eliminated by fire per API 607.
 - All seat rings and O-rings include graphite secondary seals to achieve firesafe requirements for API 607.
 - All o-rings are meet anti-explosive decompression requirements.
- All sizes/ANSI classes are double block and bleed capable in accordance with API 6D.
- The drain valve can be utilized for block and bleed function or to check seat integrity during maintenance.
- All sizes/classes are provided with emergency stem and seat injection capabilities in the event of damage. Valves $\geq 16''$ are provided with 2 seat injection ports. Small bore valves $\leq 4''$ will be provided with center body cavity injection due to size constraints.
- The valves are hydro tested excluding the injection fittings as there is a buried check valve installed underneath the fittings in the valve body. Therefore, a damaged fitting can be replaced without the need to re-hydro test the valve shell (body integrity remains intact).
- Valve stems are anti-blowout, designed in accordance with API 6D to ensure body cavity pressure cannot eject stem.
- The design incorporates two springs to assure electric continuity between the stem/body/ball to eliminate static build-up.
- The mounting pad provided is standard to ISO 5211 for ease of automation.
- All valves are standard with a lockable handle or gear per API 608.



ADDITIONAL OPTIONS

- Ranger™ valves are available as standard with ASTM A105 or A350-LF2 bodies, 3MIL ENP or 316SS trim components and polymer seats. Alternate materials can be provided based upon application specifics.
- Cryogenic designs and test capabilities are available.
- For severe service (high temperature or abrasive media), metal seated design options can be provided.
- Valves are provided with factory enamel coating, custom coating or colors can be offered based upon specific needs.
- Additional testing or documentation is available and can be offered as required.



SELF-RELIEVING, DIB-1, AND DIB-2 SEAT DESIGN

SELF-RELIEVING (SINGLE PISTON EFFECT): For this design, the seat retains tight contact with the ball in one direction. The line pressures upstream and downstream act upon the back of the seat retainers to force each of the seat rings more tightly against the ball. In the event that the body cavity pressure exceeds either the upstream or downstream line pressure, the body pressure will create a thrust that will push the seat ring away from the ball and allow the pressure to equalize between the cavity and the line. This overpressure release can occur in either the full open or close valve position. This style of valve is fully bi-directional for installation.

PRESSURE ACTING UPSTREAM AND/OR DOWNSTREAM PRESSURE $B > A$
A=BODY CAVITY PRESSURE, B=LINE PRESSURE

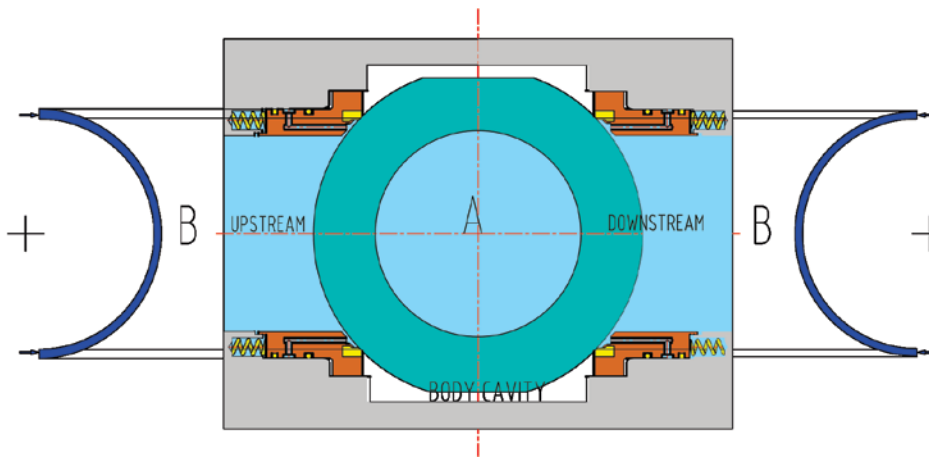

PRESSURE ACTING IN THE BODY CAVITY PRESSURE $A > B$
A=BODY CAVITY PRESSURE, B=LINE PRESSURE

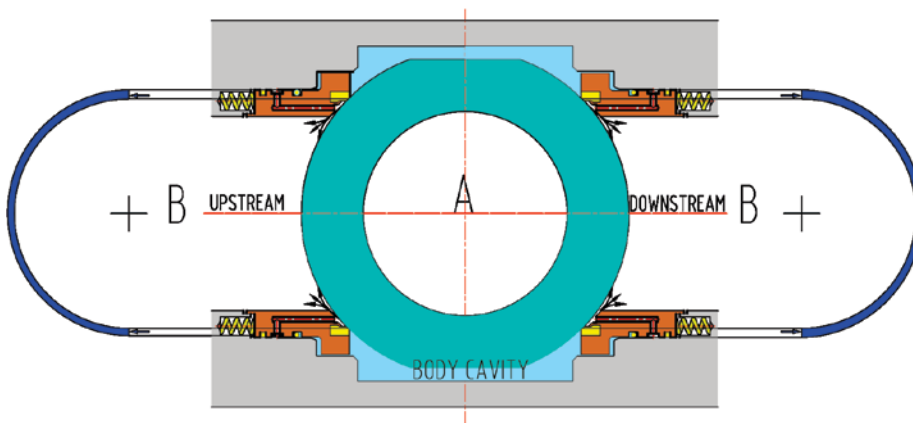

DIB-1 (DOUBLE PISTON EFFECT)

In the double piston effect design, the seat remains in tight contact with the ball in both directions. The line pressures upstream, downstream and in the body cavity will all act to increase the thrust forcing the seats into the ball. Therefore in full open or closed positions, the media in the body cavity will always be fully isolated from the line media. Dependent upon the application, this design of valve may require additional pressure relief devices to protect the valve in case of over-pressure of the body cavity. A common example of this

requirement would be a liquid service where the media is subject to thermal expansion. This valve is also fully bi-directional for installation purposes, though if provided with cavity pressure relief piped to the flange, the valve would need to be installed so the media pressure release discharges to the upstream or downstream side based upon site requirements.

PRESSURE ACTING UPSTREAM AND/OR DOWNSTREAM PRESSURE $B > A$
 A =BODY CAVITY PRESSURE, B =LINE PRESSURE

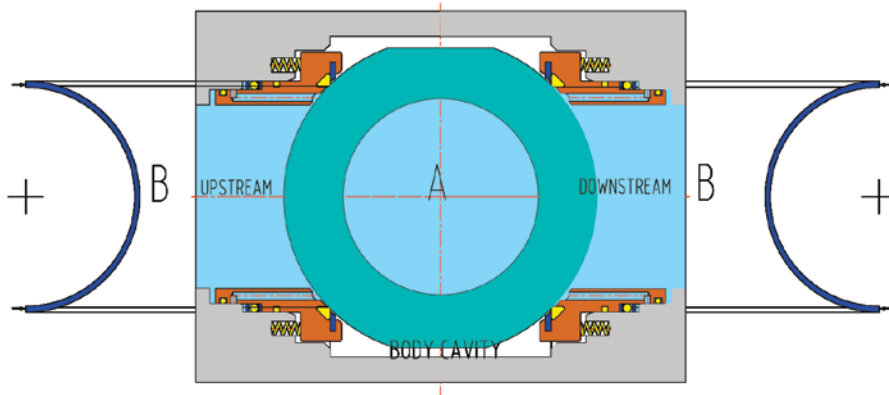

PRESSURE ACTING IN THE BODY CAVITY PRESSURE $A > B$
 A =BODY CAVITY PRESSURE, B =LINE PRESSURE

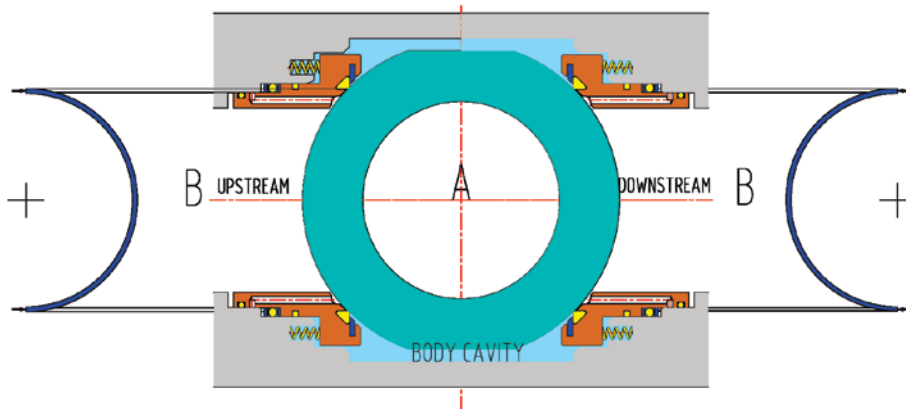

DIB-2 - SAFE RELIEVING (ONE SINGLE PISTON SEAT + ONE DOUBLE PISTON EFFECT SEAT)

The DIB-2 design incorporates one of each seat in the valve construction. This will create a unidirectional valve with the double piston effect seat typically protecting the downstream line. In the case of body cavity pressure exceeding the line pressure, the single piston effect seat will allow for

pressure to relieve (typically upstream) and equalize. There is no need to provide for additional pressure relief with this design, as it provides for the relief through the single piston effect seat.

PRODUCT RANGE API 6D FP & RP

SIZE	ANSI 150	ANSI 300	ANSI 600	ANSI 900	ANSI 1500	ANSI 2500
2	●	●	●	●	●	●
3	●	●	●	●	●	●
4	●	●	●	●	●	●
6	●	●	●	●	●	●
8	●	●	●	●	●	●
10	●	●	●	●	●	●
12	●	●	●	●	●	●
14	●	●	●	●	●	
16	●	●	●	●	●	
18	●	●	●	●	●	
20	●	●	●	●	●	
24	●	●	●	●	●	
28	●	●	●	●		
30	●	●	●	●		
32	●	●	●	●		
34	●	●	●			
36	●	●	●			
40	●	●	●			
42	●	●	●			
48	●	●	●			
56	●	●	●			



DESIGN & TEST STANDARDS

DESIGN	API 6D, CSAZ245.15, API 608, ISO 17292, CSA B51
PRESSURE/TEMPERATURE	ASME B16.34
FACE-TO-FACE	ASME B16.10
END FLANGES	RF/RTJ: ASME B16.5 >24": B16.47/MSS SP-44 BW: B16.25
FIRESAFE	API 607
SOUR SERVICE	NACE MR0175/ISO 15156
TOP FLANGE	ISO 5211
INSPECTION	API 598
TESTING	API 6D, CSA Z245.15 (includes both high and low pressure air seat test)
MARKING	MSS SP-25, API 6D, CSA Z245.15
QUALITY	MSS SP-55
DOCUMENTATION	BS EN 1020403.1

CROSS SECTIONAL DRAWING & BOM

NO.	NAME	ENP TRIM	SS316 TRIM
1	BODY	A350 LF2 CL 1	A350 LF2 CL 1
2	ENDCAP	A350 LF2 CL 1	A350 LF2 CL 1
3	BALL	A350 LF2 CL 1+0.075mm ENP	A182 F316
4	SEAT	A350 LF2 CL 1+0.075mm ENP	A182 F316
5	STEM	A29 4140+0.075mm ENP	A182 F316
6	SEATRING	DEVLON	DEVLON
7	UPPERCAP	A350 LF2 CL 1+0.075mm ENP	A350 LF2 CL 1+0.075mm ENP
8	TRUNNION	A350 LF2 CL 1+0.075mm ENP	A182 F316
9	LIMITSTOP P LATE	A350 LF2 CL 1	A350 LF2 CL 1
10	SEALANT INJECTION VALVE	A350 LF2 CL 1+0.03mm ENP	A350 LF2 CL 1+0.03mm ENP
11	DRAIN VALVE	A350 LF2 CL 1+0.03mm ENP	A350 LF2 CL 1+0.03mm ENP
12	SEALANT INJECTION VALVE	A350 LF2 CL 1+0.03mm ENP	A350 LF2 CL 1+0.03mm ENP
13	SEATSPRING	INCONEL X-750	INCONEL X-750
14	ANTISTATICSRING	A276 316	A276 316
15	FIRE SAFE GASKET	GRAPHITE+316SS	GRAPHITE+316SS
16	FIRE SAFE GASKET	GRAPHITE+316SS	GRAPHITE+316SS
17	FIRE SAFE GASKET	GRAPHITE+316SS	GRAPHITE+316SS
18	FIRE SAFE GASKET	GRAPHITE+316SS	GRAPHITE+316SS
19	FIRE SAFE GASKET	GRAPHITE+316SS	GRAPHITE+316SS
20	TRUNNION SEAL O-RING	HNBR-LT(AED)	HNBR-LT(AED)
21	BODY SEAL O-RING	HNBR-LT(AED)	HNBR-LT(AED)
22	SEAT SEAL O-RING	HNBR-LT(AED)	HNBR-LT(AED)
23	UPPERCAP SEAL O-RING	HNBR-LT(AED)	HNBR-LT(AED)
24	STEM SEAL O-RING	HNBR-LT(AED)	HNBR-LT(AED)
25	STUD	A320 L7M	A320 L7M
26	NUT	A194 7M	A194 7M
27	ALLEN HEAD BOLT	A320 L7M	A320 L7M
28	ALLEN HEAD BOLT	A320 L7M	A320 L7M
29	BEARING	AISI 1045+PTFE	AISI 1045+PTFE
30	BEARING	AISI 1045+PTFE	AISI 1045+PTFE
31	THRUST WASHER	RPTFE	RPTFE
32	SUPPORT FEET	A36	A36
33	CHECK VALVE	A350 LF2 CL 1+0.03mm ENP	A350 LF2 CL 1+0.03mm ENP
34	KEY	AISI 1045	AISI 1045
35	GEAR OPERATOR	ASSEMBLY	ASSEMBLY
36	PIN	AISI 1566	AISI 1566
37	PIN	AISI 1566	AISI 1566
38	STUD	A320 L7M	A320 L7M
39	NUT	A194 7M	A194 7M
40	VENT VALVE	A350 LF2 CL 1+0.03mm ENP	A350 LF2 CL 1+0.03mm ENP
41	LIFTING LUGS	A36	A36
42	ANTISTATICBALL	A276 316	A276 316
43	ALLEN HEAD BOLT	A320 L7M	A320 L7M
44	DRILLED, TAPPED AND PLUGGED PORT	* A350 LF2 CL 1+0.03mm ENP	A350 LF2 CL 1+0.03mm ENP
45	DRILLED, TAPPED AND PLUGGED PORT	* A350 LF2 CL 1+0.03mm ENP	A350 LF2 CL 1+0.03mm ENP

NOTE: OTHER MATERIALS AVAILABLE TO SUITSERVICE CONDITIONS.
* ON DIB-1 VALVES ONLY

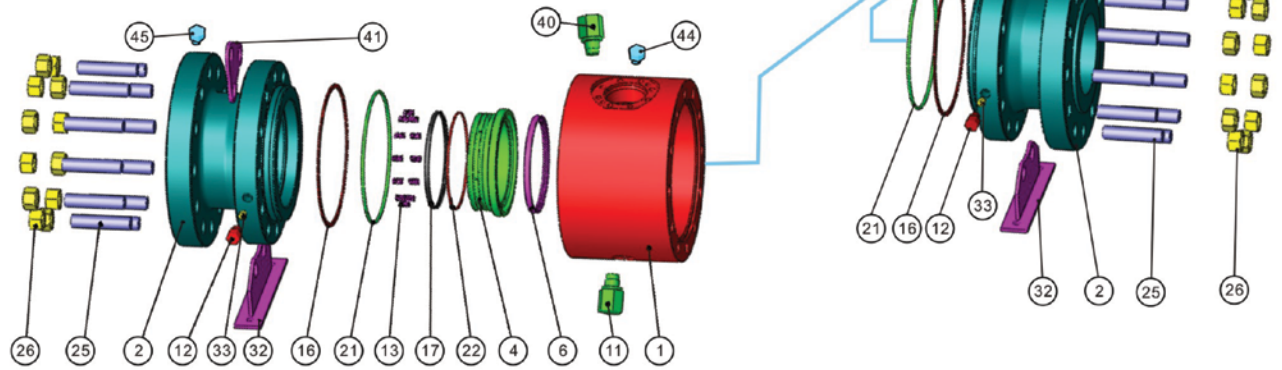
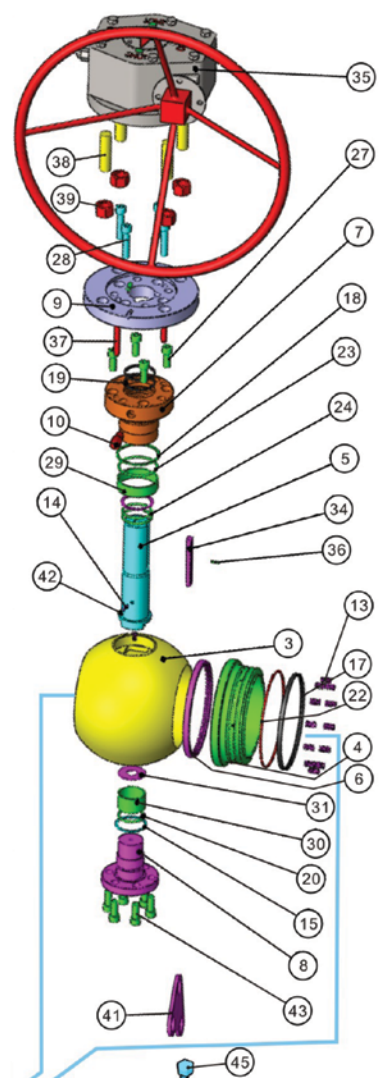

CROSS SECTIONAL DRAWING & BOM

NO.	NAME	ENP TRIM	SS316 TRIM
1	BODY	A350 LF2 CL 1	A350 LF2 CL 1
2	END CAP	A350 LF2 CL 1	A350 LF2 CL 1
3	BALL	A350 LF2 CL 1+0.075mm ENP	A182 F316
4	SEAT	A350 LF2 CL 1+0.075mm ENP	A182 F316
5	UPPER CAP	A350 LF2 CL 1+0.075mm ENP	A350 LF2 CL 1+0.075mm ENP
6	TRUNNION	A350 LF2 CL 1+0.075mm ENP	A182 F316
7	SEAT RING	RPTFE(15%~20% CF)	RPTFE(15%~20% CF)
8	STEM	A29 4140+0.075mm ENP	A182 F316
9	LIMIT STOP PLATE	A350 LF2 CL 1	A350 LF2 CL 1
10	LOCKING PLATE	A36+Zn	A36+Zn
11	LEVER HEAD	A216 WCB	A216+WCB
12	LEVER	AISI 1020	AISI 1020
13	INDICATING PLATE	A276 304	A276 304
14	KEY	AISI 1045	AISI 1045
15	FIRE SAFE GASKET	GRAPHITE+316SS	GRAPHITE+316SS
16	FIRE SAFE GASKET	GRAPHITE+316SS	GRAPHITE+316SS
17	FIRE SAFE GASKET	GRAPHITE+316SS	GRAPHITE+316SS
18	FIRE SAFE GASKET	GRAPHITE+316SS	GRAPHITE+316SS
19	FIRE SAFE PACKING	GRAPHITE+316SS	GRAPHITE+316SS
20	THRUST WASHER	RPTFE	RPTFE
21	ALLEN HEAD BOLT	A320 L7M	A320 L7M
22	ALLEN HEAD BOLT	A320 L7M	A320 L7M
23	ALLEN HEAD BOLT	A320 L7M	A320 L7M
24	HEX HEAD BOLT	304SS	304SS
25	HEX HEAD BOLT	304SS	304SS
26	NUT	A194 7M	A194 7M
27	STUD	A320 L7M	A320 L7M
28	PIN	AISI 1566	AISI 1566
29	PIN	AISI 1566	AISI 1566
30	TRUNNION SEAL O-RING	HNBR-LT(AED)	HNBR-LT(AED)
31	BODY SEAL O-RING	HNBR-LT(AED)	HNBR-LT(AED)
32	SEAT SEAL O-RING	HNBR-LT(AED)	HNBR-LT(AED)
33	UPPER CAP SEAL O-RING	HNBR-LT(AED)	HNBR-LT(AED)
34	STEM SEAL O-RING	HNBR-LT(AED)	HNBR-LT(AED)
35	BEARING	AISI 1045+PTFE	AISI 1045+PTFE
36	BEARING	AISI 1045+PTFE	AISI 1045+PTFE
37	SEAT SPRING	INCONEL X-750	INCONEL X-750
38	ANTISTATIC SPRING	A276 316	A276 316
39	DRAIN VALVE	A350 LF2 CL 1+0.03mm ENP	A350 LF2 CL 1+0.03mm ENP
40	SEALANT INJECTION VALVE	A350 LF2 CL 1+0.03mm ENP	A350 LF2 CL 1+0.03mm ENP
41	SEALANT INJECTION VALVE	A350 LF2 CL 1+0.03mm ENP	A350 LF2 CL 1+0.03mm ENP
42	CHECK VALVE	A350 LF2 CL 1+0.03mm ENP	A350 LF2 CL 1+0.03mm ENP
43	ANTISTATIC SPRING	A276 316	A276 316
44	ANTISTATIC BALL	A276 316	A276 316
45	WASHER	NYLON	NYLON
46	DRILLED, TAPPED AND PLUGGED PORT	* A350 LF2 CL 1+0.03mm ENP	A350 LF2 CL 1+0.03mm ENP
47	DRILLED, TAPPED AND PLUGGED PORT	* A350 LF2 CL 1+0.03mm ENP	A350 LF2 CL 1+0.03mm ENP

NOTE: OTHER MATERIALS AVAILABLE TO SUIT SERVICE CONDITIONS.
* ON DIB-1 VALVES ONLY

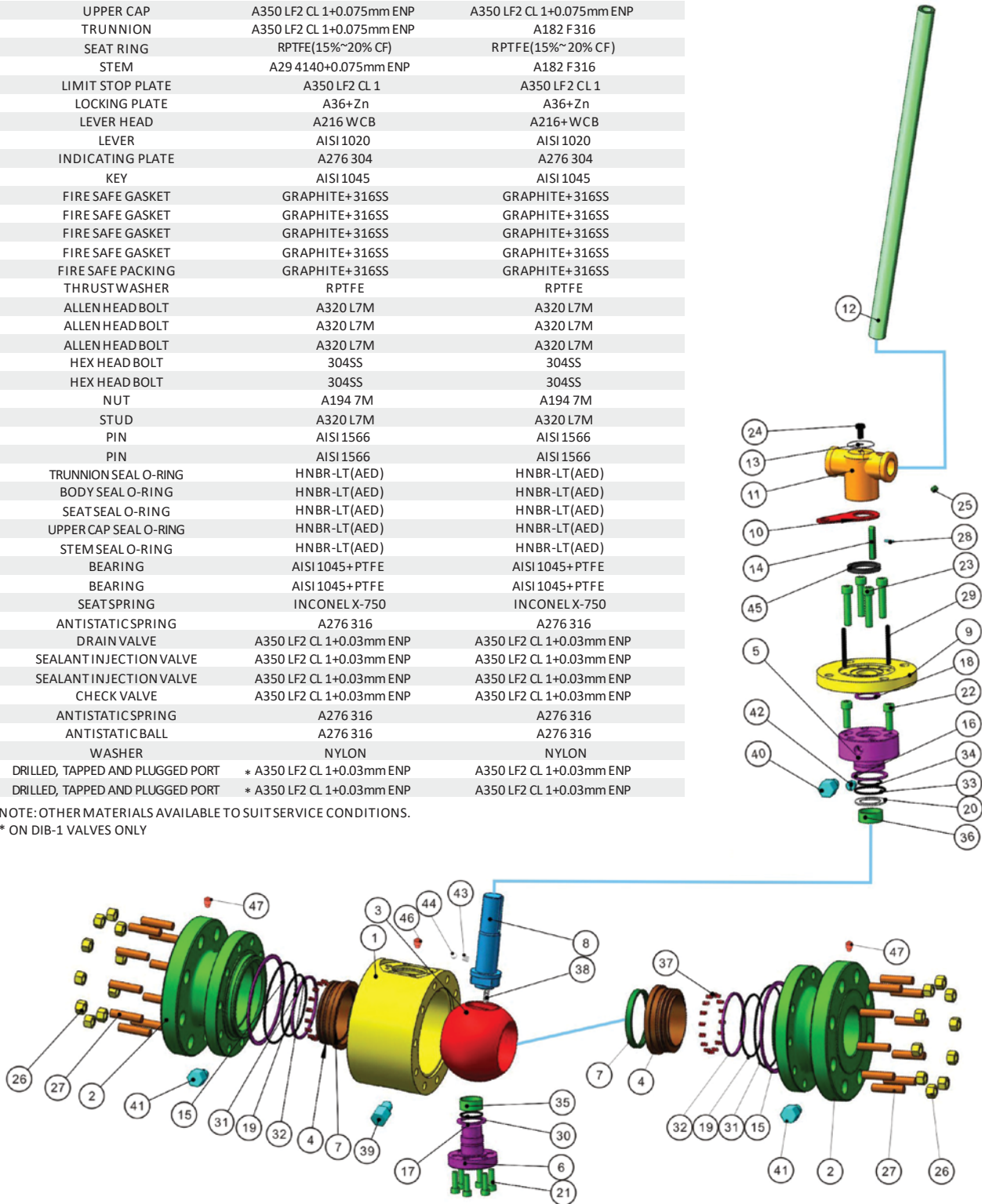

SIZES AND WEIGHTS

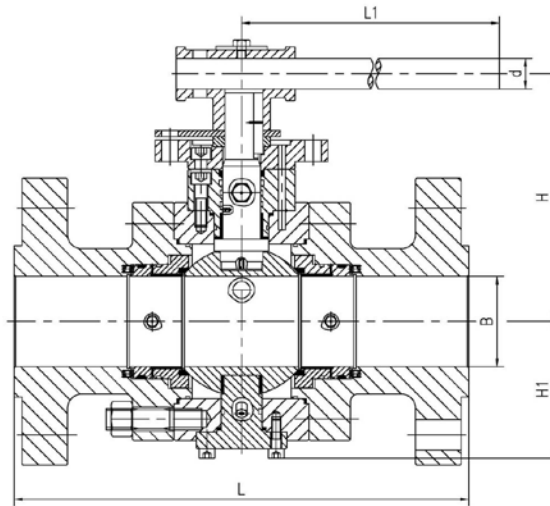

2" TO 6" LEVER OPERATED ASME CLASS 150-2500#

SIZE IN INCHES, DIMENSIONS IN INCHES

ASME	SIZE	B-Port	L-RF	L-RTJ	H	H1	L1	d	WT (POUNDS)
150	2x1-1/2	1.50	7.01	7.52	*	*	*	*	33
150	2	1.97	7.01	7.52	6.54	3.54	11.81	0.79	37
150	3x2	1.97	7.99	8.50	6.54	3.54	11.81	0.79	66
150	3	2.95	7.99	8.50	7.83	4.37	15.75	0.98	82
150	4x3	2.95	9.02	9.49	7.83	4.37	15.75	0.98	93
150	4	3.94	9.02	9.49	8.74	5.12	17.72	0.98	108
150	6x4	3.94	15.51	15.98	8.74	5.12	17.72	0.98	220
300	2x1-1/2	1.50	8.50	9.13	6.22	3.54	11.81	0.79	44
300	2	1.97	8.50	9.13	6.54	3.54	11.81	0.79	49
300	3x2	1.97	11.10	11.73	6.54	3.54	11.81	0.79	88
300	3	2.95	11.10	11.73	7.83	4.37	19.69	0.98	99
300	4x3	2.95	12.01	12.64	7.83	4.37	19.69	0.98	132
300	4	3.94	12.01	12.64	8.70	5.12	23.62	0.98	154
300	6x4	3.94	15.87	16.50	8.70	5.12	23.62	0.98	331
600	2x1-1/2	1.50	11.50	11.61	6.22	3.54	15.91	0.79	62
600	2	1.97	11.50	11.61	6.61	3.74	19.69	0.79	71
600	3x2	1.97	14.02	14.13	6.61	3.74	19.69	0.79	106
600	3	2.95	14.02	14.13	8.03	4.53	23.62	0.98	123
600	4x3	2.95	17.01	17.13	8.03	4.53	23.62	0.98	176
600	4	3.94	17.01	17.13	8.86	5.39	27.56	0.98	231
600	6x4	3.94	22.01	22.13	8.86	5.39	27.56	0.98	463
900	2x1-1/2	1.50	14.49	14.61	*	*	*	*	88
900	2	1.93	14.49	14.61	7.01	3.98	23.62	0.98	106
900	3x2	1.93	15.00	15.12	7.01	3.98	23.62	0.98	121
900	3	2.91	15.00	15.12	8.19	4.49	29.92	0.98	183
900	4x3	2.91	17.99	18.11	8.19	4.49	29.92	0.98	220
1500	2x1-1/2	1.50	14.49	14.61	7.20	4.09	19.69	0.98	99
1500	2	1.93	14.49	14.61	7.01	3.98	23.62	0.98	137
1500	3x2	1.93	18.50	18.62	7.01	3.98	23.62	0.98	243
1500	3	2.91	18.50	18.62	10.31	5.79	34.72	1.38	298
1500	4x3	2.91	21.50	21.61	10.31	5.79	34.72	1.38	331
2500	2	1.65	17.76	17.87	9.33	5.47	35.43	1.38	265
2500	3x2	1.65	22.76	22.99	9.33	5.47	35.43	1.38	401

Note: envelope dimensions remain the same independent of seat design.

* contact Ranger™ for details.

SIZES AND WEIGHTS

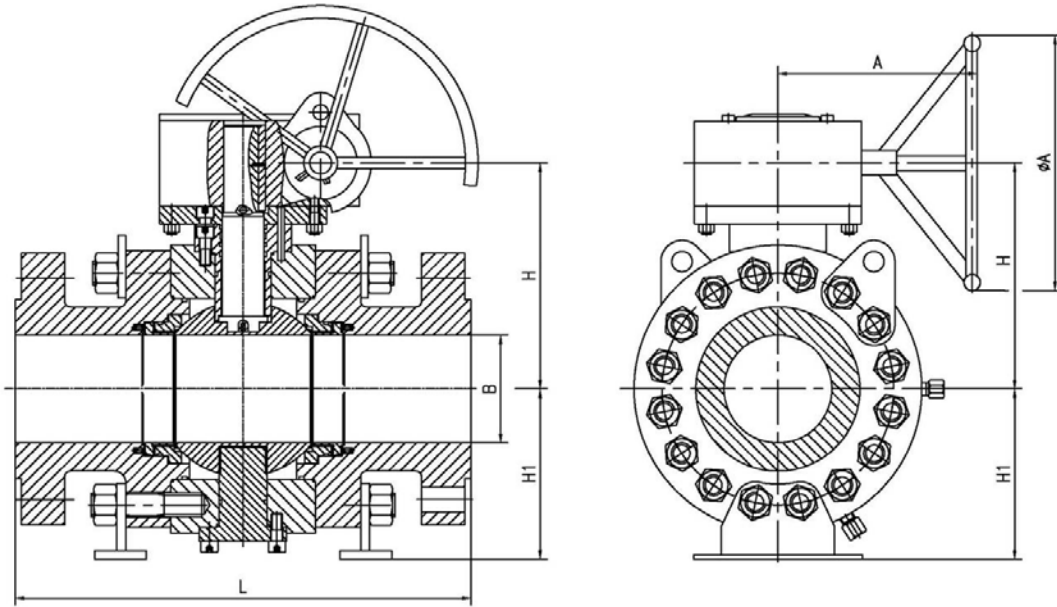

6" TO 48" GEAR OPERATED ASME CLASS 150#

SIZE IN INCHES, DIMENSIONS IN INCHES

ASME	SIZE	B-PORT	L-RF	L-RTJ	H	H1	A	DIA A	WT (POUNDS)
150	6	5.94	15.51	15.98	10.47	8.07	9.02	18.31	340
	8x6	5.94	17.99	18.50	10.47	8.07	9.02	18.31	481
150	8	7.95	17.99	18.50	12.40	9.57	14.17	23.62	595
	10x8	7.95	20.98	21.50	12.40	9.57	14.17	23.62	816
150	10	9.92	20.98	21.50	14.17	11.81	15.83	23.62	1019
	12x10	9.92	24.02	24.49	14.17	11.81	15.83	23.62	1179
150	12	11.93	24.02	24.49	15.47	13.19	15.83	23.62	1424
	14x12	11.93	27.01	27.52	15.47	13.19	15.83	23.62	1863
150	14	13.15	27.01	27.52	16.57	14.06	15.83	23.62	2112
	16x14	13.15	30.00	30.51	16.57	14.06	15.83	23.62	2557
150	16	15.16	30.00	30.51	21.65	16.14	20.47	23.62	2751
	18x16	15.16	34.02	34.49	21.65	16.14	20.47	23.62	2976
150	18	17.17	34.02	34.49	25.20	19.21	21.38	29.53	3175
	20x18	17.17	35.98	36.50	25.20	19.21	21.38	29.53	4079
150	20	19.17	35.98	36.50	*	*	*	*	4321
	24x20	19.17	42.01	42.52	*	*	*	*	5600
150	24	23.19	42.01	42.52	26.81	24.29	23.78	29.53	6195
	30x24	23.19	50.98	*	26.81	24.29	23.78	29.53	10031
150	30	28.94	50.98	*	*	*	*	*	10692
	36x30	28.94	60.00	*	*	*	*	*	*
150	36	34.41	60.00	*	*	*	*	*	19731
	42x36	34.41	73.03	*	*	*	*	*	*
150	42	40.16	73.03	*	*	*	*	*	31856
	48x42	40.16	84.02	*	*	*	*	*	*
150	48	45.91	84.02	*	*	*	*	*	47950

Note: envelope dimensions remain the same independent of seat design.
* contact Ranger™ for details.

SIZES AND WEIGHTS

6" TO 48" GEAR OPERATED ASME CLASS 300#

SIZE IN INCHES, DIMENSIONS IN INCHES

ASME	SIZE	B-PORT	L-RF	L-RTJ	H	H1	A	DIA A	WT (POUNDS)
300	6	5.94	15.87	16.50	10.47	8.07	9.02	18.31	386
	8x6	5.94	19.76	20.39	10.47	8.07	9.02	18.31	525
300	8	7.95	19.76	20.39	12.40	9.57	14.17	23.62	721
	10x8	7.95	22.36	22.99	12.40	9.57	14.17	23.62	842
300	10	9.92	22.36	22.99	14.17	11.81	15.83	23.62	1102
	12x10	9.92	25.51	26.14	14.17	11.81	15.83	23.62	1257
300	12	11.93	25.51	26.14	18.70	13.58	20.47	23.62	1620
	14x12	11.93	30.00	30.63	18.70	13.58	20.47	23.62	2161
300	14	13.15	30.00	30.63	20.67	15.28	20.47	23.62	2562
	16x14	13.15	32.99	33.62	20.67	15.28	20.47	23.62	2756
300	16	15.16	32.99	33.62	23.23	16.61	21.38	29.53	3289
	18x16	15.16	35.98	36.61	23.23	16.61	21.38	29.53	3571
300	18	17.17	35.98	36.61	25.16	19.21	21.38	29.53	3862
	20x18	17.17	39.02	39.76	25.16	19.21	21.38	29.53	4211
300	20	19.17	39.02	39.76	*	*	*	*	5941
	24x20	19.17	45.00	45.87	*	*	*	*	6305
300	24	23.19	45.00	45.87	27.76	23.62	25.28	29.53	7077
	30x24	23.19	55.00	55.98	27.76	23.62	25.28	29.53	10053
300	30	28.94	55.00	55.98	*	*	*	*	12324
	36x30	28.94	67.99	69.13	*	*	*	*	17315
300	36	34.41	67.99	69.13	*	*	*	*	22663
	42x36	34.41	82.01	*	*	*	*	*	*
300	42	40.16	82.01	*	*	*	*	*	35935
	48x42	40.16	85.43	*	*	*	*	*	*
300	48	45.91	85.43	*	*	*	*	*	53572

6" TO 48" GEAR OPERATED ASME CLASS 600#

SIZE IN INCHES, DIMENSIONS IN INCHES

ASME	SIZE	B-PORT	L-RF	L-RTJ	H	H1	A	DIA A	WT (POUNDS)
600	6	5.94	22.01	22.13	10.67	8.70	14.17	23.62	573
	8x6	5.94	25.98	26.14	10.67	8.70	14.17	23.62	842
600	8	7.95	25.98	26.14	13.19	11.02	15.83	23.62	1025
	10x8	7.95	30.98	31.14	13.19	11.02	15.83	23.62	1303
600	10	9.92	30.98	31.14	17.64	12.83	20.47	23.62	1653
	12x10	9.92	32.99	33.11	17.64	12.83	20.47	23.62	1887
600	12	11.93	32.99	33.11	20.47	13.98	21.38	29.53	2403
	14x12	11.93	35.00	35.12	20.47	13.98	21.38	29.53	2535
600	14	13.15	35.00	35.12	21.50	15.35	21.38	29.53	2943
	16x14	13.15	39.02	39.13	21.50	15.35	21.38	29.53	3439
600	16	15.16	39.02	39.13	20.12	16.54	23.78	29.53	3990
	18x16	15.16	42.99	43.11	20.12	16.54	23.78	29.53	5071
600	18	17.17	42.99	43.11	*	*	*	*	5512
	20x18	17.17	47.01	47.24	*	*	*	*	6063
600	20	19.17	47.01	47.24	26.14	21.38	25.98	29.53	6614
	24x20	19.17	55.00	55.39	26.14	21.38	25.98	29.53	9149
600	24	23.19	55.00	55.39	*	*	*	*	11023
	30x24	23.19	65.00	65.51	*	*	*	*	13448
600	30	28.94	65.00	65.51	*	*	*	*	16689
	36x30	28.94	82.01	82.64	*	*	*	*	20428
600	36	34.41	82.01	82.64	*	*	*	*	29828
	42x36	34.41	95.94	95.94	*	*	*	*	*
600	42	40.16	95.94	95.94	*	*	*	*	47597
	48x42	40.16	100.00	100.00	*	*	*	*	*
600	48	45.91	100.00	100.00	*	*	*	*	69555

Note: envelope dimensions remain the same independent of seat design.
 * contact Ranger™ for details

SIZES AND WEIGHTS

4" TO 30" GEAR OPERATED ASME CLASS 900#

SIZE IN INCHES, DIMENSIONS IN INCHES

ASME	SIZE	B-PORT	L-RF	L-RTJ	H	H1	A	DIA A	WT (POUNDS)
900	4	3.94	17.99	18.11	9.21	7.87	9.02	18.31	280
	6x4	3.94	24.02	24.13	9.21	7.87	9.02	18.31	529
900	6	5.91	24.02	24.13	11.14	9.53	15.83	23.62	672
	8x6	5.91	29.02	29.13	11.14	9.53	15.83	23.62	1058
900	8	7.91	29.02	29.13	16.54	11.14	20.47	23.62	1235
	10x8	7.91	32.99	33.11	16.54	11.14	20.47	23.62	1653
900	10	9.92	32.99	33.11	19.69	12.60	21.38	29.53	1892
	12x10	9.92	37.99	38.11	19.69	12.60	21.38	29.53	2315
900	12	11.93	37.99	38.11	18.39	13.98	23.78	29.53	2961
	14x12	11.93	40.51	40.87	18.39	13.98	23.78	29.53	3351
900	14	12.68	40.51	40.87	*	*	*	*	3549
	16x14	12.68	44.49	44.88	*	*	*	*	4079
900	16	14.69	44.49	44.88	22.56	18.78	25.31	29.53	5567
	18x16	14.69	47.99	48.50	*	*	*	*	5930
900	18	16.65	47.99	48.50	*	*	*	*	6327
	20x18	16.65	52.01	52.52	*	*	*	*	6504
900	20	18.54	52.01	52.52	*	*	*	*	7672
	24x20	18.54	60.98	61.73	*	*	*	*	7937
900	24	22.44	60.98	61.73	*	*	*	*	15498
	30x24	22.44	74.02	74.88	*	*	*	*	22487
900	30	28.03	74.02	74.88	*	*	*	*	27425

4" TO 30" GEAR OPERATED ASME CLASS 1500#

SIZE IN INCHES, DIMENSIONS IN INCHES

ASME	SIZE	B-PORT	L-RF	L-RTJ	L-WE	H	H1	A	DIA A	WT (POUNDS)
1500	4	3.94	21.50	21.61	21.50	10.28	8.23	14.17	23.62	430
	6x4	3.94	27.76	27.99	27.76	10.28	8.23	14.17	23.62	904
1500	6	5.67	27.76	27.99	27.76	16.89	10.63	20.47	23.62	1016
	8x6	5.67	32.76	33.11	32.76	16.89	10.63	20.47	23.62	1235
1500	8	7.56	32.76	33.11	32.76	20.04	12.60	21.38	29.53	1411
	10x8	7.56	39.02	39.41	39.02	20.04	12.60	21.38	29.53	2050
1500	10	9.41	39.02	39.41	39.02	18.94	15.04	23.78	29.53	2668
	12x10	9.41	44.49	45.12	44.49	18.94	15.04	23.78	29.53	2989
1500	12	11.30	44.49	45.12	44.49	*	*	*	*	3510
	14x12	11.30	49.49	50.24	49.49	*	*	*	*	4034
1500	14	12.40	49.49	50.24	49.49	*	*	*	*	4982
	16x14	12.40	54.49	55.35	54.49	*	*	*	*	5644
1500	16	14.17	54.49	55.35	54.49	*	*	*	*	8289
	18x16	14.17	60.51	61.38	60.51	*	*	*	*	12244
1500	18	15.98	60.51	61.38	60.51	*	*	*	*	14109
	20x18	15.98	65.51	66.38	65.51	*	*	*	*	16581
1500	20	17.87	65.51	66.38	65.51	*	*	*	*	17769
	24x20	17.87	76.54	77.64	*	*	*	*	*	24079
1500	24	21.50	76.54	77.64	*	*	*	*	*	32077

Note: envelope dimensions remain the same independent of seat design.

3" TO 12" GEAR OPERATED ASME CLASS 2500#

SIZE IN INCHES, DIMENSIONS IN INCHES

ASME	SIZE	B-PORT	L-RF	L-RTJ	L-WE	H	H1	A	DIA A	WT (POUNDS)
2500	3	2.44	22.76	22.99	22.76	9.88	7.36	14.17	23.62	474
	4x3	2.44	26.50	26.89	26.50	9.88	7.36	14.17	23.62	606
2500	4	3.43	26.50	26.89	26.50	11.34	9.45	15.83	23.62	858
	6x4	3.43	35.98	36.50	35.98	11.34	9.45	15.83	23.62	1160
2500	6	5.16	35.98	36.50	35.98	*	*	*	*	3360
	8x6	5.16	40.24	40.87	40.24	*	*	*	*	3578
2500	8	7.05	40.24	40.87	40.24	*	*	*	*	4145
	10x8	7.05	50.00	50.87	50.00	*	*	*	*	5337
2500	10	8.78	50.00	50.87	50.00	*	*	*	*	6922
	12x10	8.78	55.98	56.85	55.98	*	*	*	*	7795
2500	12	10.43	55.98	56.85	55.98	*	*	*	*	9392

Note: envelope dimensions remain the same independent of seat design.
* contact Ranger™ for details.

TOPWORKS DIMENSIONS

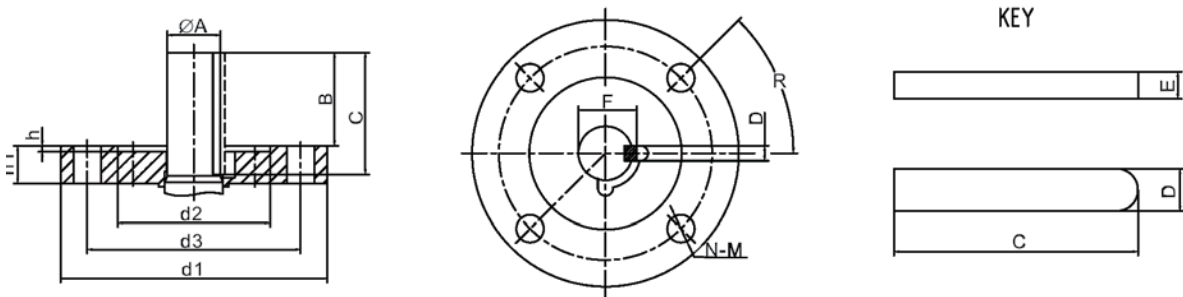

ASME CLASS 150 SIZE IN INCHES, DIMENSIONS IN INCHES

NPS	A	B	C	D	E	F	ISO	d1	d2	d3	N-M	h	h1	R
2"	1.02	1.38	1.77	0.31	0.28	1.14	F10	4.92	2.76	4.02	4- Φ 12	0.12	0.55	45°
3"	1.18	1.57	1.97	0.31	0.28	1.30	F12	5.91	3.35	4.92	4- Φ 14	0.12	0.67	45°
4"	1.38	1.61	2.20	0.39	0.31	1.50	F12	5.91	3.35	4.92	4- Φ 14	0.16	0.83	45°
6"	1.85	3.11	3.94	0.55	0.35	1.99	F16	8.27	5.12	6.50	4- Φ 22	0.24	0.96	45°
8"	2.05	3.46	4.33	0.63	0.39	2.20	F16	8.27	5.12	6.50	4- Φ 23	0.24	0.96	45°
10"	2.44	3.35	4.33	0.71	0.43	2.60	F25	11.81	7.87	10.00	8- Φ 18	0.24	0.98	22.5°
12"	2.44	3.46	4.33	0.71	0.43	2.60	F25	11.81	7.87	10.00	8- Φ 18	0.24	1.00	22.5°
14"	2.83	3.70	4.72	0.79	0.47	3.01	F25	11.81	7.87	10.00	8- Φ 18	0.24	0.98	22.5°
16"	2.83	4.57	5.51	0.79	0.47	3.01	F25	11.81	7.87	10.00	8- Φ 18	0.24	1.04	22.5°
18"	3.15	4.72	5.91	0.87	0.55	3.35	F25	11.81	7.87	10.00	8- Φ 18	0.24	1.10	22.5°
20"	3.54	4.72	5.91	0.98	0.55	3.74	F25	11.81	7.87	10.00	8- Φ 18	0.24	1.10	22.5°
24"	4.13	5.12	6.50	1.10	0.63	4.37	F30	13.78	9.06	11.73	8- Φ 22	0.24	0.98	22.5°
30"	*	*	*	*	*	*	*	*	*	*	*	*	*	*
36"	*	*	*	*	*	*	*	*	*	*	*	*	*	*
42"	*	*	*	*	*	*	*	*	*	*	*	*	*	*
48"	*	*	*	*	*	*	*	*	*	*	*	*	*	*

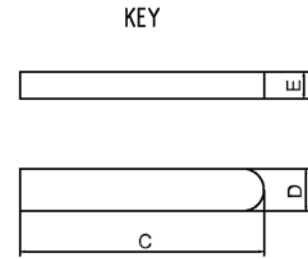
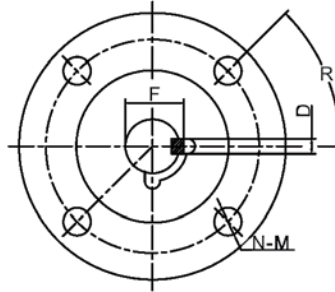
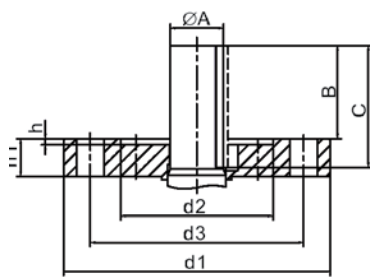

ASME CLASS 300 **SIZE IN INCHES, DIMENSIONS IN INCHES**

NPS	A	B	C	D	E	F	ISO	d1	d2	d3	N-M	h	h1	R
2x1 1/2"	0.79	1.16	1.57	0.24	0.24	0.89	F10	4.92	2.76	4.02	4-Φ12	*	0.55	45°
2"	1.02	1.38	1.77	0.31	0.28	1.14	F10	4.92	2.76	4.02	4-Φ12	0.12	0.55	45°
3"	1.18	1.57	1.97	0.31	0.28	1.30	F12	5.91	3.35	4.92	4-Φ14	0.12	0.67	45°
4"	1.38	1.61	2.20	0.39	0.31	1.50	F12	5.91	3.35	4.92	4-Φ14	0.16	0.79	45°
6"	1.85	3.11	3.94	0.55	0.35	1.99	F16	8.27	5.12	6.50	4-Φ22	0.24	0.96	45°
8"	2.05	3.46	4.33	0.63	0.39	2.20	F16	8.27	5.12	6.50	4-Φ23	0.24	0.96	45°
10"	2.44	3.35	4.33	0.71	0.43	2.60	F25	11.81	7.87	10.00	8-Φ18	0.24	0.98	22.5°
12"	2.44	3.46	4.33	0.71	0.43	2.60	F25	11.81	7.87	10.00	8-Φ18	0.24	1.00	22.5°
14"	2.83	3.94	5.12	0.79	0.47	3.01	F25	11.81	7.87	10.00	8-Φ18	0.24	1.18	22.5°
16"	2.83	4.57	5.51	0.79	0.47	3.01	F25	11.81	7.87	10.00	8-Φ18	0.24	1.04	22.5°
18"	3.15	4.33	5.51	0.87	0.55	3.35	F25	11.81	7.87	10.00	8-Φ18	0.24	1.10	22.5°
20"	*	*	*	*	*	*	*	*	*	*	*	*	*	*
24"	4.13	5.12	6.50	1.10	0.63	4.37	F35	16.34	10.24	14.02	8-Φ33	0.24	1.26	22.5°
30"	*	*	*	*	*	*	*	*	*	*	*	*	*	*
36"	*	*	*	*	*	*	*	*	*	*	*	*	*	*
42"	*	*	*	*	*	*	*	*	*	*	*	*	*	*
48"	*	*	*	*	*	*	*	*	*	*	*	*	*	*

ASME CLASS 600 **SIZE IN INCHES, DIMENSIONS IN INCHES**

NPS	A	B	C	D	E	F	ISO	d1	d2	d3	N-M	h	h1	R
2"	1.02	1.38	1.77	0.31	0.28	1.14	F10	4.92	2.76	4.02	4-Φ12	0.12	0.55	45°
3"	1.18	1.57	1.97	0.31	0.28	1.30	F12	5.91	3.35	4.92	4-Φ14	0.12	0.67	45°
4"	1.38	1.61	2.20	0.39	0.31	1.50	F12	5.91	3.35	4.92	4-Φ14	0.16	0.79	45°
6"	1.85	3.11	3.94	0.55	0.35	1.99	F16	8.27	5.12	6.50	4-Φ22	0.24	0.96	45°
8"	2.05	3.46	4.33	0.63	0.39	2.20	F25	11.81	7.87	10.00	8-Φ18	0.24	0.96	22.5°
10"	2.44	3.35	4.33	0.71	0.43	2.60	F25	11.81	7.87	10.00	8-Φ18	0.24	0.98	22.5°
12"	2.83	4.61	5.51	0.79	0.47	3.01	F25	11.81	7.87	10.00	8-Φ18	0.24	0.96	22.5°
14"	3.35	4.61	5.51	0.87	0.55	3.54	F30	13.78	9.06	11.73	8-Φ22	0.24	0.98	22.5°
16"	3.62	5.24	6.30	0.98	0.55	3.82	F30	13.78	9.06	11.73	8-Φ22	0.24	0.96	22.5°
18"	*	*	*	*	*	*	*	*	*	*	*	*	*	*
20"	4.33	5.12	6.50	1.10	0.63	4.57	F35	16.34	10.24	14.02	8-Φ33	0.24	1.77	22.5°
24"	*	*	*	*	*	*	*	*	*	*	*	*	*	*
30"	*	*	*	*	*	*	*	*	*	*	*	*	*	*
36"	*	*	*	*	*	*	*	*	*	*	*	*	*	*
42"	*	*	*	*	*	*	*	*	*	*	*	*	*	*
48"	*	*	*	*	*	*	*	*	*	*	*	*	*	*

Note: topworks dimensions remain the same independent of seat design.
 * contact Ranger™ for details.

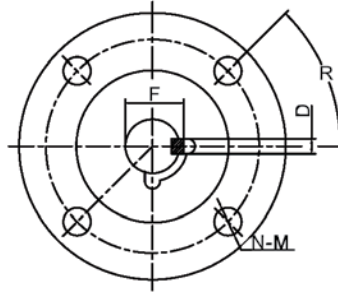
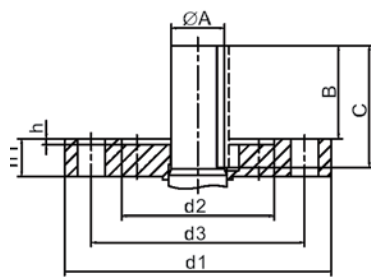

KEY

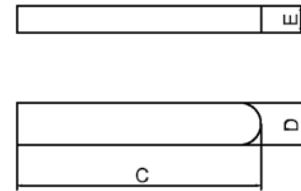

ASME CLASS 900

SIZE IN INCHES, DIMENSIONS IN INCHES

NPS	A	B	C	D	E	F	ISO	d1	d2	d3	N-M	h	h1	R
2"	1.02	1.42	1.97	0.31	0.28	1.14	F12	5.91	3.35	4.92	4-Φ14	0.16	0.91	45°
3"	1.18	1.61	2.17	0.31	0.28	1.30	F12	5.91	3.35	4.92	4-Φ14	0.16	0.94	45°
4"	1.38	2.40	3.15	0.39	0.31	1.50	F14	6.89	3.94	5.51	4-Φ18	0.20	0.98	45°
6"	1.85	3.07	3.94	0.55	0.35	1.99	F25	11.81	7.87	10.00	8-Φ18	0.24	1.10	22.5°
8"	2.83	3.07	3.94	0.79	0.47	3.01	F25	11.81	7.87	10.00	8-Φ18	0.24	1.22	22.5°
10"	2.83	2.99	3.94	0.79	0.47	3.01	F25	11.81	7.87	10.00	8-Φ18	0.24	0.98	22.5°
12"	3.54	4.72	5.91	0.98	0.55	3.74	F25	11.81	7.87	10.00	8-Φ18	0.24	0.98	22.5°
14"	*	*	*	*	*	*	*	*	*	*	*	*	*	*
16"	4.53	6.69	8.27	1.26	0.71	4.80	F35	16.34	10.24	14.02	8-Φ33	0.24	1.57	22.5°
18"	*	*	*	*	*	*	*	*	*	*	*	*	*	*
20"	*	*	*	*	*	*	*	*	*	*	*	*	*	*
24"	*	*	*	*	*	*	*	*	*	*	*	*	*	*
30"	*	*	*	*	*	*	*	*	*	*	*	*	*	*

ASME CLASS 1500

SIZE IN INCHES, DIMENSIONS IN INCHES

NPS	A	B	C	D	E	F	ISO	d1	d2	d3	N-M	h	h1	R
2"	1.02	1.42	1.97	0.31	0.28	1.14	F12	5.91	3.35	4.92	4-Φ14	0.16	0.91	45°
3"	1.50	2.40	2.95	0.39	0.31	1.61	F16	8.27	5.12	6.50	4-Φ22	*	1.14	45°
4"	1.85	3.11	3.94	0.55	0.35	1.99	F16	8.27	5.12	6.50	4-Φ22	0.24	1.24	45°
6"	2.24	3.27	4.13	0.63	0.39	2.40	F25	11.81	7.87	10.00	8-Φ18	0.24	1.57	22.5°
8"	3.15	4.72	5.87	0.87	0.55	3.35	F25	11.81	7.87	10.00	8-Φ18	0.24	1.71	22.5°
10"	3.74	5.12	6.30	0.98	0.55	3.94	F30	13.78	9.06	11.73	8-Φ23	0.24	1.79	22.5°
12"	*	*	*	*	*	*	*	*	*	*	*	*	*	*
16"	*	*	*	*	*	*	*	*	*	*	*	*	*	*
18"	*	*	*	*	*	*	*	*	*	*	*	*	*	*
20"	*	*	*	*	*	*	*	*	*	*	*	*	*	*
24"	*	*	*	*	*	*	*	*	*	*	*	*	*	*

ASME CLASS 2500

SIZE IN INCHES, DIMENSIONS IN INCHES

NPS	A	B	C	D	E	F	ISO	d1	d2	d3	N-M	h	h1	R
2"	1.38	1.69	2.36	0.39	0.31	1.50	F16	8.27	5.12	6.50	4-Φ22	*	1.18	45°
3"	1.65	2.68	3.54	0.47	0.31	1.77	F16	8.27	5.12	6.50	4-Φ22	0.24	1.22	45°
4"	2.05	3.11	3.94	0.63	0.39	2.20	F25	11.22	7.87	10.00	8-Φ18	0.24	1.38	22.5°
6"	*	*	*	*	*	*	*	*	*	*	*	*	*	*
8"	*	*	*	*	*	*	*	*	*	*	*	*	*	*
10"	*	*	*	*	*	*	*	*	*	*	*	*	*	*
12"	*	*	*	*	*	*	*	*	*	*	*	*	*	*

Note: topworks dimensions remain the same independent of seat design.

* contact Ranger™ for details.

TORQUE VALUES

SIZE (INCH)	OPEN TORQUE AT MAX. PRESSURE					
	150#	300#	600#	900#	1500#	2500#
1.5"	293	400	764	1156	1733	2302
2"	364	604	1200	1876	2044	3964
3"	480	764	1973	3244	4560	7129
4"	1004	1600	3493	5067	8364	14116
6"	2889	4640	7600	11778	21511	44000
8"	5440	10640	16400	27360	46356	69316
10"	8364	17662	23600	41804	88320	130951
12"	12160	20951	33404	68400	126000	272800
14"	15964	29796	52000	121600		
16"	25067	42240	70684	163404	240000	
18"	28000	47200	81840	202276	259138	
20"	37200	67600	102400	232000	500320	
24"	52453	99556	169964	360000	820000	
28"	91360	174400	267200	466400		
30"	109840	234160	337600	720000		
36"	193600	365280	521440			
42"	288400	611840	994960			
48"	318160	699680	1114400			

ADDITIONAL NOTES

1. Torque values above are for new valves in clean water service.
2. Torque values are in inch pound, and excluded a safety factor.
3. Required safety factor is 1.35.
4. For unclean service, an additional safety factor of 30% is required.
5. For dry gas service, an additional safety factor of 50% is required.
6. Torques reflect valve bore, for RP select appropriate bore size.
7. Torques above are based upon standard seat insert offerings. Class 150 & 300: PTFE; Class 600: DEVLON; and Class 2500: PEEK. Consult Ranger for torques for different seat materials.

CV VALUES

FULL BORE						
SIZE(IN)	150#	300#	600#	900#	1500#	2500#
2	647	647	647	599	582	412
3	2086	2086	2086	1932	1879	1268
4	2694	2694	2694	2494	2426	1766
6	6062	6062	6062	5612	5030	4004
8	10885	10885	10885	10077	8943	7476
10	17109	17109	17109	15840	13857	11603
12	24734	24734	24734	22990	19982	16385
14	30055	30055	30055	25862	24071	
16	39934	39934	39934	34703	31440	
18	51214	51214	51214	44630	39988	
20	63896	63896	63896	53333	50002	
24	96465	96465	96465	81039	72321	
30	145588	145588	145588	129948		
36	211092	211092	211092			
42	280946	280946	280946			
48	383846	383846	383846			

REDUCED BORE						
SIZE(IN)	150#	300#	600#	900#	1500#	2500#
2x1 1/2	306	306	306	306	306	300
3x2	377	377	377	377	377	347
4x3	1043	1043	1043	1043	1043	681
6x4	1587	1587	1587	1587	1353	953
8x6	4364	4364	4364	4364	4065	3197
10x8	7495	7495	7495	7495	6986	6057
12x10	13470	13470	13470	13470	12171	10999
14x12	24702	24702	24702	22276	20780	
16x14	27737	27737	27737	25275	24551	
18x16	34740	34740	34740	32387	31002	
20x18	47739	47739	47739	45666	41158	
24x20	49304	49304	49304	46021	43687	
30x28	96762	96762	96762	94231		
36x30	119199	119199	119199			
42x36	180836	180836	180836			
48x42	267636	267636	267636			

PRESSURE & TEMPERATURE CHART FOR TYPICAL SEAT & SEAL MATERIALS

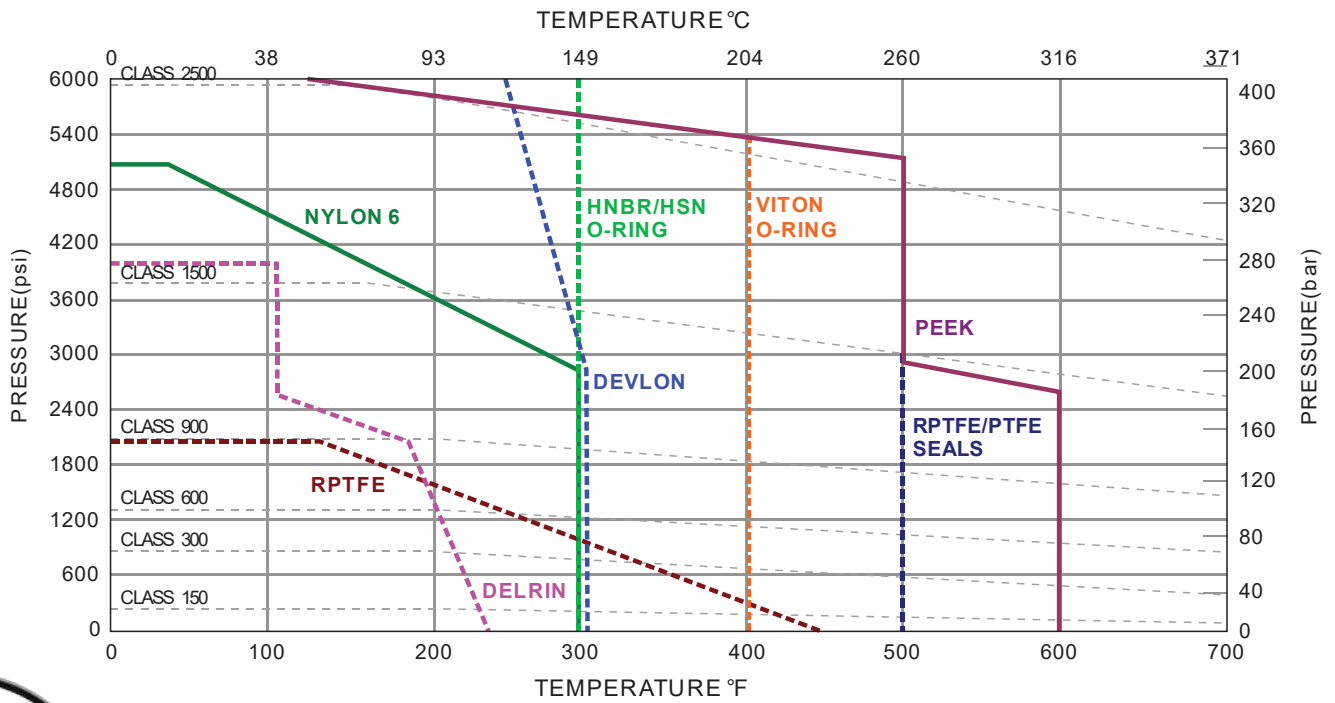

CONSULT ASME 16.34 FOR SPECIFIC MATERIAL PRESSURE/TEMPERATURE RATINGS.



PART NUMBER CONFIGURATION

T	B3	F	16	R	06	N	G	6	4	4	B	H
1	2	3	4	5	6	7	8	9	10	11	12	13

1-VALVE TYPE	2-BODY CONSTRUCTION	3-PORT TYPE
--------------	---------------------	-------------

T=Trunnion DBB
 T1=Trunnion DIB-1
 T2=Trunnion DIB-2
 F=Floating

B2=Bolted 2 piece
 B3=Bolted 3 piece
 TE=Top Entry
 WB=Welded Body

F=Full Bore
 R=Reduced Bore

4-NOMINAL SIZE

050=1/2"	30=3"	140=14"	280=28"
075=3/4"	40=4"	160=16"	300=30"
10=1"	60=6"	180=18"	320=32"
15=1 1/2"	80=8"	200=20"	360=36"
20=2"	100=10"	240=24"	420=42"
25=2 1/2"	120=12"	260=26"	480=48"

5-CONNECTION	6-PRESSURE	7-SERVICE
--------------	------------	-----------

R-RF
 B-BW
 J-RTJ

01=150
 03=300
 06=600
 09=900
 15=1500
 25=2500

L=Low Temp. NACE
 N=Regular Temp. NACE
 A=Corrosive NACE
 R=Regular Temp.
 O=Oxygen
 C=Cryogenic
 H=High Temp.

8-TOP WORKS	9-BODY MATERIAL	10-BALL MATERIAL
-------------	-----------------	------------------

G=Gear
 L=Lever
 B-Bare Stem
 A-Actuator

1=A216 WCB
 2=A105N
 3=LCC
 4=LF2
 5=CF8M
 6=F316
 7=Duplex
 8=Super Duplex
 X=Special

1=A105N+ENP
 2=LF2+ENP
 3=4140+ENP
 4=F316
 5=F6A
 6=F51
 7=F53
 8=F55
 X=Special

11-STEM MATERIAL	12-SEAT MATERIAL	13-SEAL MATERIAL
------------------	------------------	------------------

1=A105N+ENP
 2=LF2+ENP
 3=4140+ENP
 4=F316
 5=F6A
 6=F51
 7=F53
 8=F55
 X=Special

A=RPTFE
 B=Devlon V
 C=PEEK
 D=Nylon
 E=Delrin
 F=Metal
 X=Special

A=Viton GLT
 V=Viton
 H=HNBR
 L=HNBR-LT
 E=PTFE+Elgiloy Spring
 G=Graphite
 T=Teflon
 X=Special

RANGER
VALVE AMERICA