

The DuraGate™

Symmetrical Expanding Gate Valve



The DuraGate™ Symmetrical Expanding Gate Valve

After nearly two decades of manufacturing double block & bleed plug valves, Franklin introduces an innovative technology into the market with the DuraGate™ Symmetrical Expanding Gate Valve. The DuraGate™ is a fully opening non-thru-conduit, rising stem, compact expanding gate valve, perfect for installations with size constraints. The DuraGate is referred to as a Symmetrical Expanding Gate Valve (SEG®), as it is a Compact Expanding Gate Valve integrated with Symmetrical Sealing Technology (SST®). The new DuraGate's patented design solves several inherent issues with current industry offerings. Franklin now proudly offers the first truly bidirectional flow SEG®, with SST® technology, for extended service life in demanding applications.

The Duragate™ Symmetrical Expanding Gate valve meets all of the following product requirements:

- API 6D, DBB & DIB-1
- API 6FA (Firesafe)
- ISO 15848-1 (Emissions)
- Designed, assembled and tested in an API Q1/ISO 9001 compliant facility



PRODUCT PATENTS :
US 11209087
CA 3112291
TW 1754155
ZL 201880098141.8

Table of Contents

Company History	2
How the DuraGate™ Symmetrical Expanding Gate Valve Works	3
Features & Benefits	4
Applications	5
DuraGate™ Symmetrical Expanding Gate Valve - Internal View	6
Standard Materials of Construction G611, G621	7
Installation Considerations	8
G600 Series ANSI 150, 300 - Dimensions	9
G600 Series ANSI 150, 300 - Flow Coefficients (CV) and Torque & Turns	10
Differential Thermal Relief Systems	11
DTR - Standard Configuration	12
DTR - Line Relieving	13



Company History

Since 2005, Franklin Valve has been on a mission to supply the oil & gas industry with a quality product, while also leading the industry in customer service and delivery. In 2014 we moved into our current facility, allowing us to better leverage our large inventory and lean manufacturing practices while expanding on our Engineering and R&D capabilities, all with the goal of better serving customer needs.

As we've grown, our **Value Proposition** has remained the same: Franklin Valve offers the highest value on product quality and customer service while leveraging our large inventories to meet and exceed customer lead times. Franklin Valve is globally distributed, represented and approved with high profile end users and Original Equipment Manufacturers.

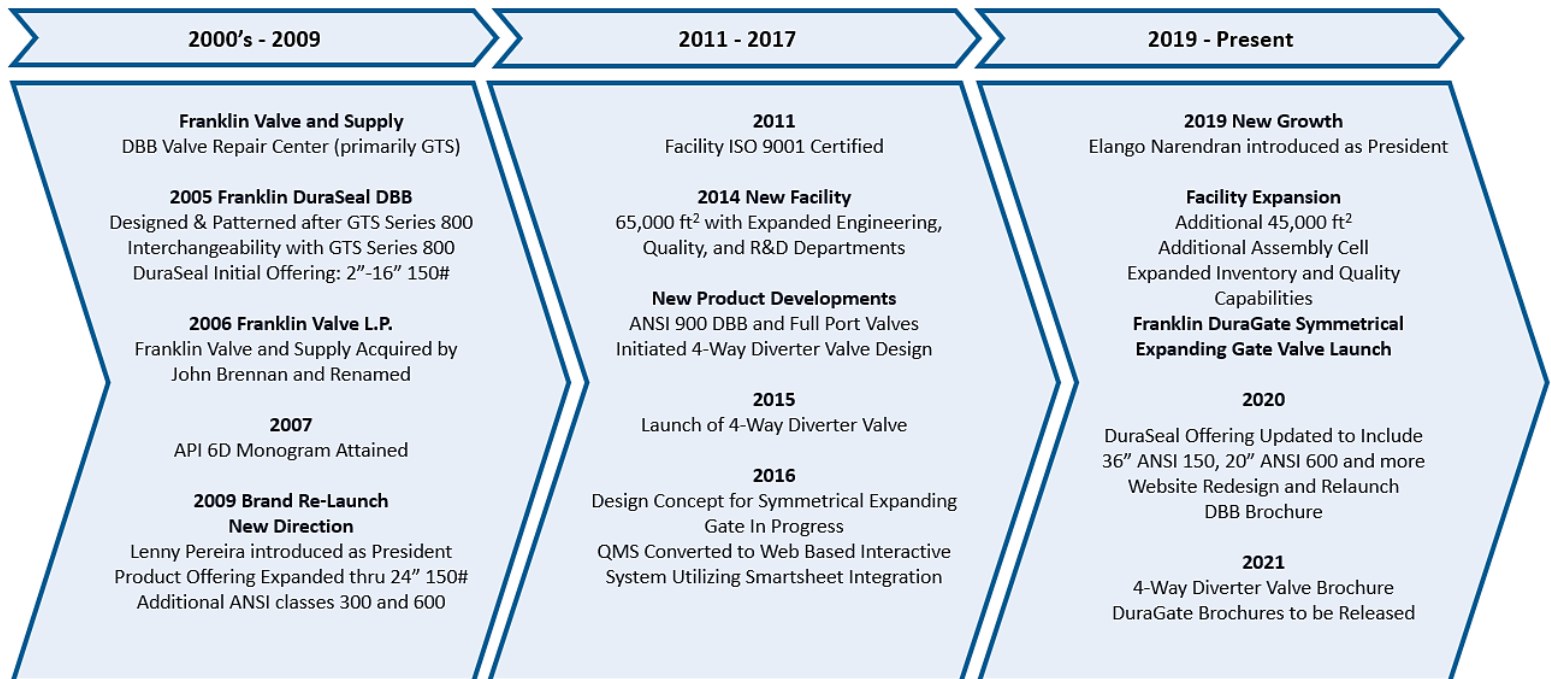

How the DuraGate™ Valve Works

Operation

The Franklin DuraGate™ Symmetrical Expanding Gate Valve is a resilient seated, compact expanding gate valve which utilizes a mechanical wedge action to perform seating and unseating functions.

Seating the gate valve, the gate and slip assembly is lowered until mechanical stops cause the assembly to begin lateral expansion. This continues until the elastomeric slip seals are compressed against the body sealing surface, creating a bubble tight seal.

Opening the valve, the central tapered gate is raised retracting the two slip seals via tapered dovetail connections. Only after the elastomeric slip seals are fully retracted from the body seat, will the closure member begin to rise up and out of the flow path.

This retraction protects the elastomeric seals from abrasion during travel, extending seal life. A patented internal centralizing mechanism ensures that full retraction is achieved even under maximum differential conditions. Additionally, while in the fully open position, the elastomer seals are positioned out of the flow path, protecting against trash and entrained solids that may be in the process fluid.

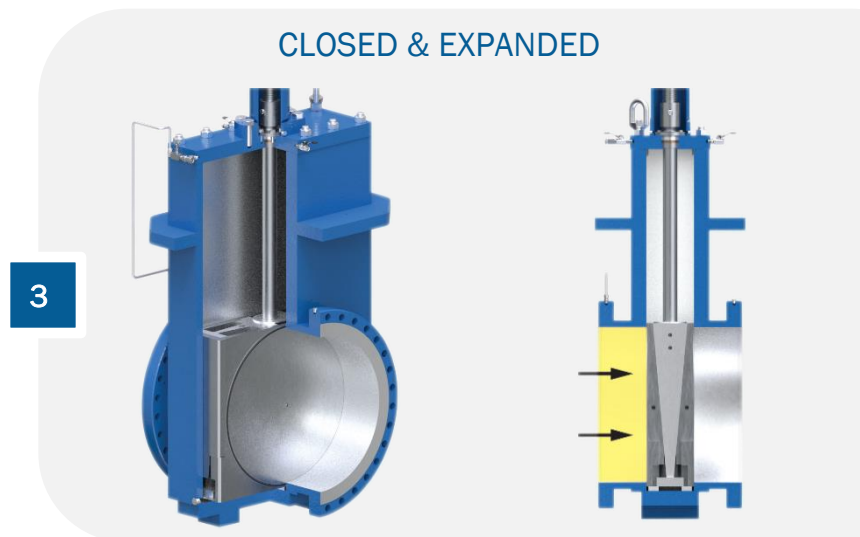
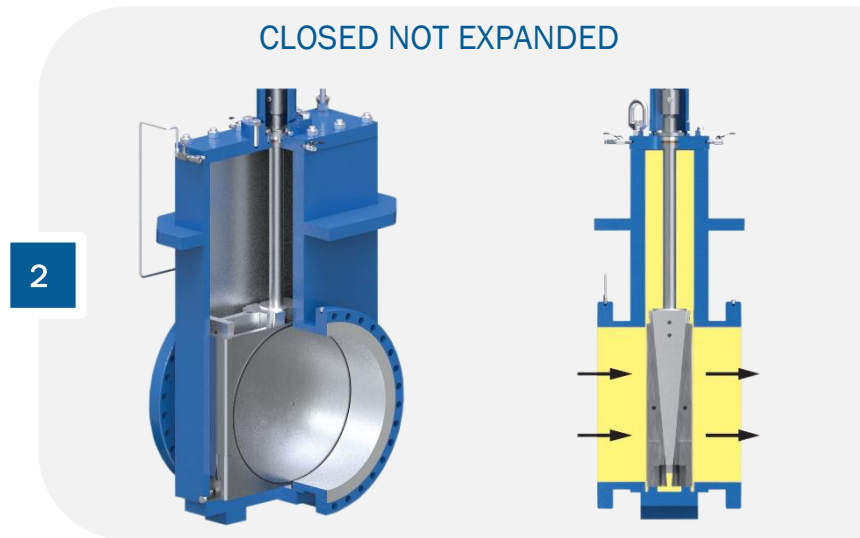
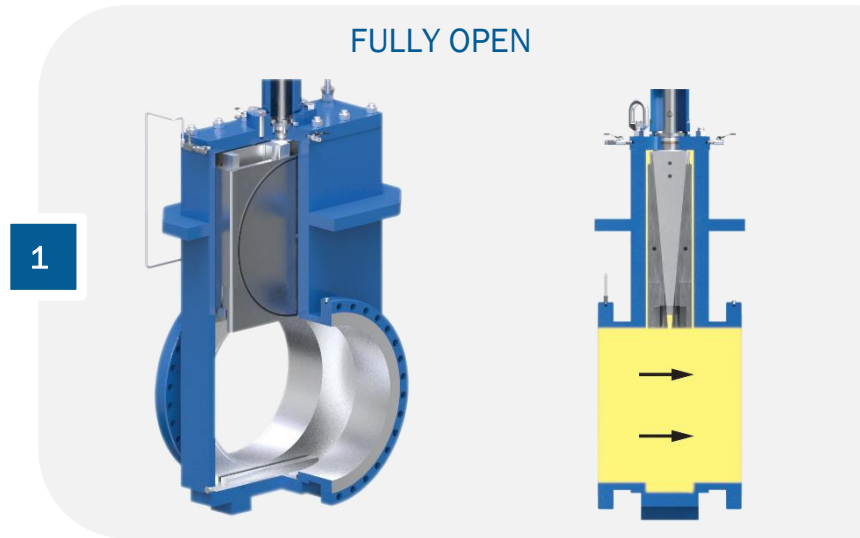

Features and Benefits



In-line Maintenance/Field Repairable

The Franklin DuraGate™ SEG® Valves are top entry and all internal components may be removed, repaired and installed without removing the body from the line.

Symmetrical Sealing Technology

The Franklin DuraGate™ patented Symmetrical Expanding Gate Valve allows for true bi-directional operation with no variance in operational requirements. Franklin's improved symmetrical design offers greater flexibility for more applications, resulting in lower inventory costs and better Return On Investment (ROI).

Improved Vertical Stability

Long stabilizing surfaces improves stability during travel and the safety and reliability for operations.

Drivetrain Strength

Designed to lead the industry in drive train strength, improving reliability and dependability in demanding actuated applications.

Compact Design

The Franklin DuraGate™ is a full opening, non-thru conduit valve. Providing superior CV values over reduced port valves, while also maintaining a compact profile perfect for optimization of space on skids and manifolds.

Reliable Bubble Tight Isolation

The Franklin DuraGate™ employs two independent bi-directional elastomer seals capable of providing consistent DBB/DIB-1 performance for critical product isolation applications. The expanding technology allows for consistent reliable isolation without the assistance of line pressure or internal springs.

Emergency Stem Sealant Injection

In critical service, powering down a line to repair a stem leak is not always immediately viable. The DuraGate™ comes standard with stem sealant injection ports and packing lantern ring to allow for fast and safe mitigation of stem leaks until maintenance can be scheduled.

Quality Manufacturing

The Franklin DuraGate™ Symmetrical Expanding Gate Valve is designed, inspected, assembled and tested in Houston, TX in an ISO 9001 certified and API Q1 compliant facility. All DuraGate™ valves come standard with an API 6D monogram nameplate, meaning every valve is tested and no batch testing is employed.

Applications

- Aviation Fueling Systems
- Bi-Directional Meter Prover
- Blending Units
- Custody Transfer Units
- Multi-Product Manifolds Terminals
- Offshore Platforms
- Prover Loops
- Tank Farms (Oil Depots)
- Terminals



DuraGate™ SEG® Valve Internal View

Easily automated with the choice of electric or hydraulic actuators. DuraGate™ SEG® Valve is available in a wide range of elastomer materials.

Applications

With bubble-tight fire-safe sealing integrity and the ability to double isolate and bleed DIB-1 from a single valve, the DuraGate™ is an excellent choice for applications that require frequent isolation and testing of gas or liquids.

- Product manifolds
- Measurement units
- Isolation of processing equipment
- Loading Racks and Tank Isolation

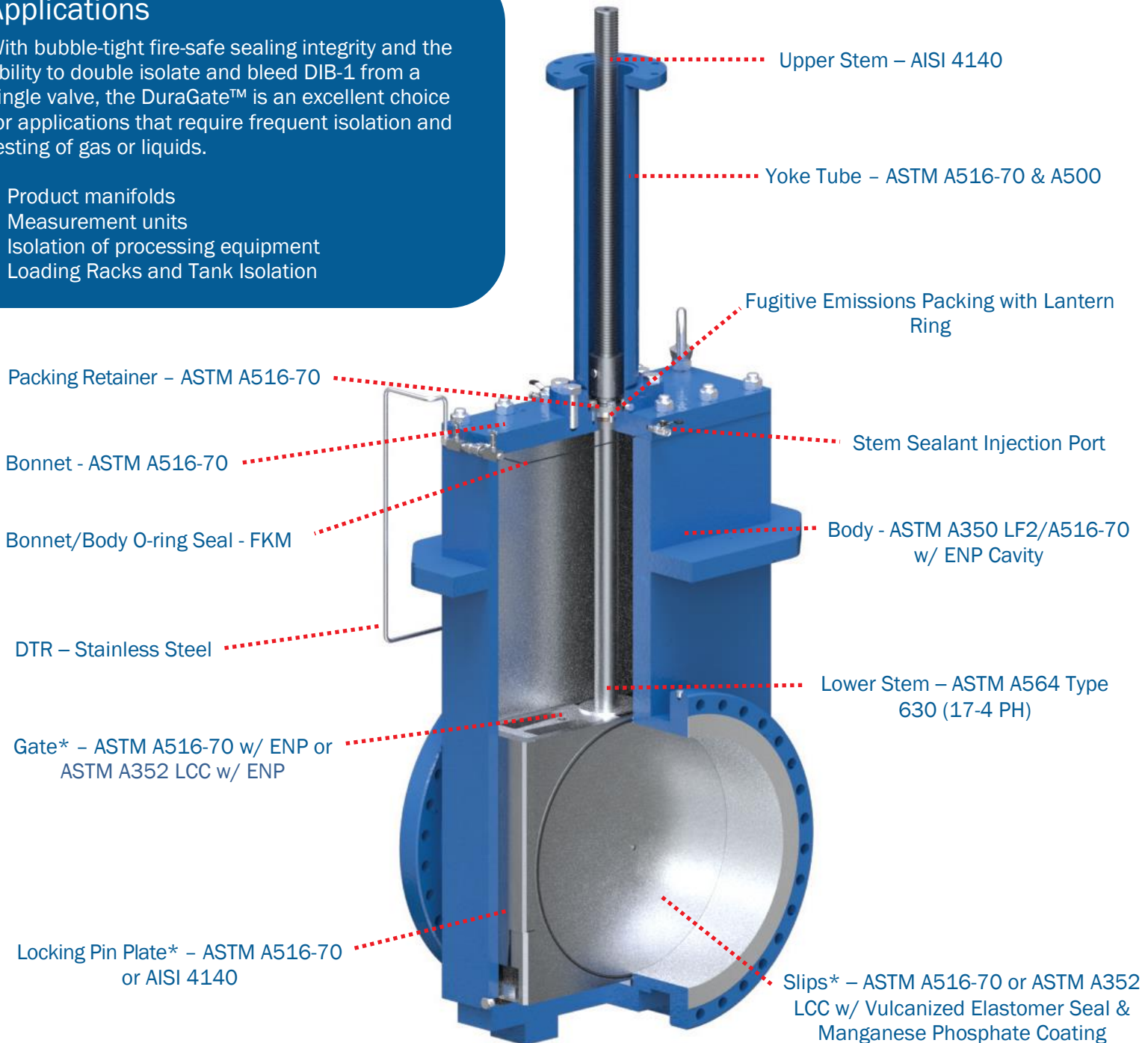

Franklin Valve reserves the right to change trim codes without prior notification.
*Size dependent, contact Franklin Valve for size specific bill of materials.

Standard Materials of Construction

SERIES	G611 ANSI 150 & G621 ANSI 300
BODY (1)	ASTM A350 LF2/A516-70 w/ ENP
BONNET	ASTM A516-70
GATE	ASTM A516-70 w/ ENP or ASTM A352 LCC
SLIPS	ASTM A516-70 or ASTM A352 LCC w/ Manganese Phosphate Coating
YOKE TUBE	ASTM A516-70 & A500-B
PACKING RETAINER	ASTM A516-70
O-RINGS & SLIP SEALS (2)	VITON* GF
FASTENERS (3)	ASTM A193 GR. B7 / 2H

Note: All Materials subject to change without notice.

(1) In Accordance with NACE MRO175 Latest Edition. (2) See Additional Options Below. (3) NACE Specification Available.

Proper seal selection requires a number of considerations such as media, pressure class, differential pressure, low temperature, high temperature, seal type, etc. To that end we have included a selection of slip seal materials and a brief list of considerations:

Fluoro Elastomers Slip Seal Materials (FKM)		
FR	Fiber Reinforced	Optional HIDP, can be added to all Elastomer options upon request.
VGF	Viton* GF	Viton* with Enhanced Chem. Resistance, Our Standard Material
VGF9	Viton* 90 Durometer GF	HIDP Viton* GF
VGFLT	Viton* GFLT	Low Temp Viton* GF
VGFLT9	Viton* 90 Durometer GFLT	HIDP Low Temp Viton* GF
VE	Viton* ETP (Extreme)	Viton* with Chem. Resistance rivaling FFKM
VE9	Viton* 90 Durometer ETP	HIDP Viton* with Chem. Resistance rivaling FFKM
Perfluoro Elastomers Slip Seal Materials (FFKM)		
KRZ	Kalrez*	Kalrez* with High Chem. Resistance
KRZ9	Kalrez* 90 Durometer	HIDP Kalrez*

All specifications and materials are subject to change without notice. Alternate seal materials may be provided upon request.

*Generic equivalents provided

Installation Considerations

1.0 SCOPE OF INSTRUCTION

- 1.1. This information provides support for the DuraGate™ Valve in regards to maintaining the maximum life and function of the valve.
- 1.2. The contained information is subject to change without notice.
- 1.3. This document provides information for standard installations. In the event of unique situations, please contact your representative or Franklin Valve.

2.0 DEFINITIONS

- 2.1. **DBB** – Double Block and Bleed, method to test seat integrity with the valve closed while under pressure.
- 2.2. **DIB-1** – Double Isolation and Bleed, Bi-Directional seating. API 6D definition of redundant sealing surfaces in both flow directions.
- 2.3. **DTR** - Differential Thermal Relief, provides the cavity relief functions of API 6D.

3.0 CONSIDERATIONS

- 3.1. Positioning of the valve to provide operational access should be considered during installation.
- 3.2. Positioning of the DTR to provide proper function. The DTR relief direction should be toward the pressure side to be isolated. In a typical piping system, there is often a specific direction. When isolating equipment such as pumps, the preferred isolation may be different from the prevailing flow direction. See Differential Thermal Relief System section for more details.
- 3.3. Positioning of bleeds and drains to provide adequate operation. On valves which require complete draining, ensure that drains are positioned to provide complete draining. For valves requiring DBB operation, it is typically preferable to position bleed valves in an elevated position with respect to valve cavity so that the DBB bleeds the minimum amount of liquid.
- 3.4. Positioning with the goal of reducing damage caused by potential debris in fluids. With solids in the fluids, it is preferable to have regular draining of the body cavity to reduce accumulation and reduction of performance. It is also preferable to have the DTR to the upper side so that solids do not damage the DTR isolation or check valves.

G600 SERIES ANSI 150, 300

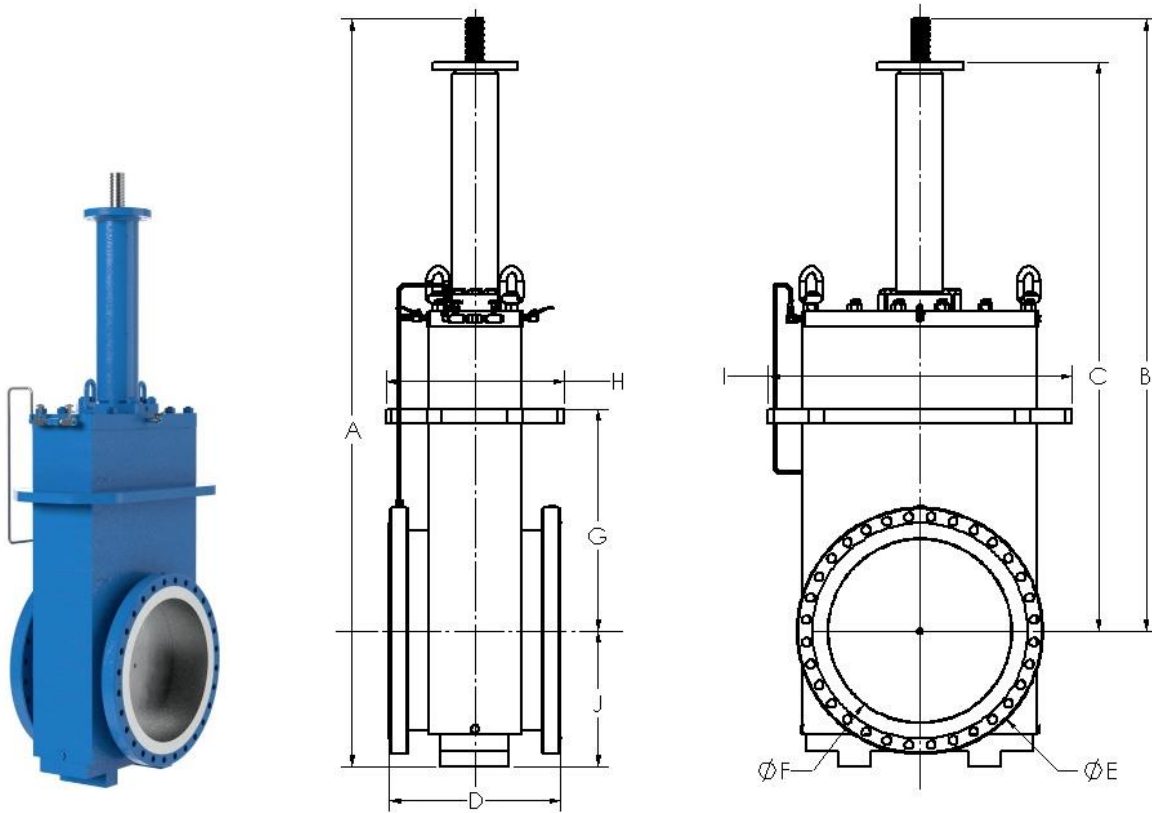

ANSI	SIZE	MODEL	A	B (2)	C	D	E	F (3)	G (4)	H	I	J	WEIGHT (1)
150	12	G611	64	53	46	14	19	11.94	N/A	N/A	N/A	11	1260
	16		75	60.5	55	16	23.50	15.19	N/A	N/A	N/A	14	2300
	20		88	72	65	18	27.50	19.19	N/A	N/A	N/A	14	3100
	24		101	82	75	20	32	23.19	N/A	N/A	N/A	16	4350
	30		123	100	92	26	38.75	28.94	36.45	25.75	49	20	8350
	36		140	114	106	32	46	34.44	41.45	33.40	57	22	13150
	42		158	129	121	36	53	40.20	59.50	34.75	62.86	28.37	20220
300	12	G621	61	50	44	19.75	20.50	11.94	N/A	N/A	N/A	11.25	1900
	16		76	63	56	33	25.50	15.19	24.32	20.84	26	13	3260
	20		90	74	67	39	30.50	19.19	30.85	24.50	35	16.48	4490
	24		105	87	79	45	36	23.19	36.27	29	42	18.73	7100
	30		123	100	93	55	43	28.94	36.49	31.52	52.50	22.61	11450

(1) Approximate Weights (lbs).

(2) Dimension B represents the valve in the seated position. Stem travel is published in the Flow Coefficients (Cv), Torque & Turns section.

(3) Dimension F represents minimum allowable.

(4) Dimension G represents upper most rib if applicable.

G600 SERIES ANSI 150, 300

ANSI	SIZE		MODEL	Cv	STEM THREAD DIAMETER	PITCH P (in)	LEAD L (in)	MOUNTING FLANGE	SEAT THRUST (lbf)	SEAT TORQUE (ft-lb)	MAX ALLOWABLE THRUST (ft-lbf)	MAX ALLOWABLE TORQUE (ft-lbf)	TOTAL STEM TRAVEL (in)	TOTAL TURNS (rev)
	NPS (in)	DN (mm)												
150	12	300	G611	13,800	1-1/2	1/6	1/3	FA14	11,059	165	22,119	330	15.51	47
	16	400		21,770	1-3/4	1/5	2/5	FA14	17,750	285	39,000	627	19.36	48
	20	500		37,630	2	1/4	1/2	FA25	26,700	505	53,350	1010	23.06	46
	24	600		53,790	2-1/4	1/4	1/2	FA25	39,000	800	78,000	1600	27.04	54
	30	750		95,210	2-5/8	1/3	2/3	FA30	60,100	1500	120,200	3000	32.81	49
	36	900		132,210	3-1/8	2/5	4/5	FA35	83,500	2490	167,000	4980	38.31	48
	42	1050		172,710	3-1/8	2/5	4/5	FA35	110,475	3293	220,945	6585	44.21	55
300	12	300	G621	13,540	2	1/4	1/2	FA16	28,725	543	57,450	1086	15.50	31
	16	400		21,500	2	1/4	1/2	FA25	46,800	1050	93,582	2095	19.64	39
	20	500		36,575	2-1/8	1/4	1/2	FA30	70,700	1456	141,400	2912	23.06	46
	24	600		53,325	2-5/8	1/3	2/3	FA35	101,800	2541	203,600	5082	27.71	42
	30	750		85,250	3-1/4	2/5	4/5	FA40	156,540	4795	313,100	9590	32.81	41

NOTES: Cv value based on SG 1 for water.
All values subject to change, reference PUB-010-EN for up-to-date values.

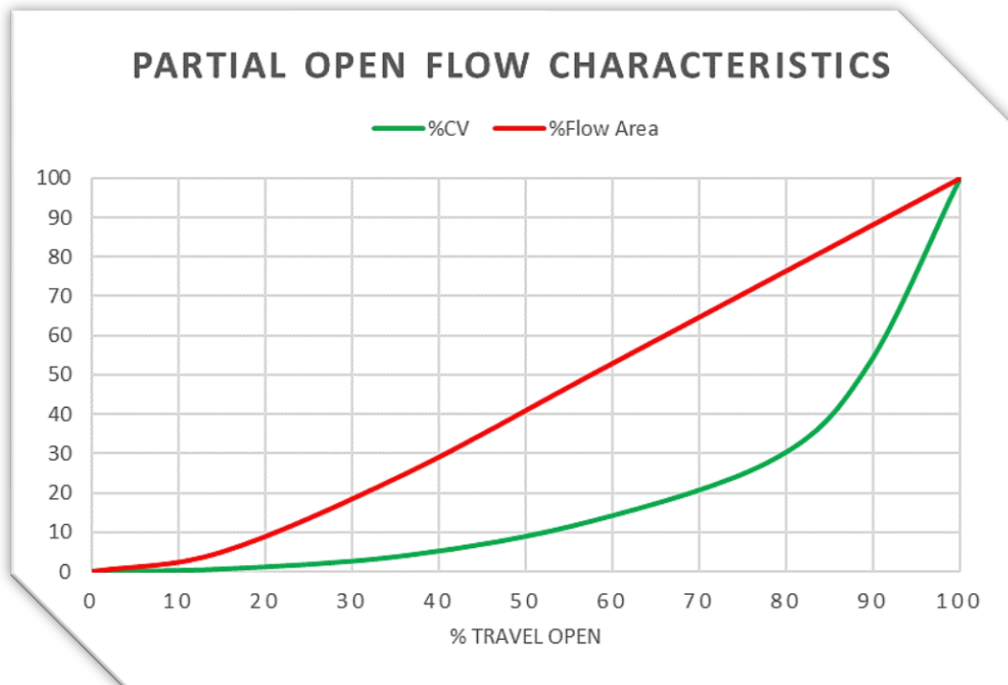

The DuraGate™ Valve is by Design a Bidirectional DIB-1 Valve

This design has inherent characteristics of trapping body cavity pressure. Because valves in liquid or condensing service can have a thermal hydraulic expansion within the trapped cavity, API 6D requires a cavity pressure relief system. The valves on the configurations permit different directionality characteristics.

These configurations relate to the operational reliefs and DBB operation. The lower body bleeds are not addressed in this document, however they should be used as necessary to eliminate line solids from accumulating under the gate.

For the following configurations, the left flange (when facing the piping of an upright valve) is the upstream flange. For installations with clearance issues, a reverse DTR may be ordered which provides the right flange as the upstream flange.

The upstream flange is the flange of preferred pressure isolation. Depending upon the required isolation, the valve preferred pressure direction may not be the direction of flow. For applications where a piece of equipment is being isolated from the piping, the preferred pressure isolation will typically be the flange away from the equipment.

Extending of the Body Bleed Outlets: For convenient bleed positions, the body bleed outlets may be extended from the NPT outlet of the manual bleed valve, retaining the original bleed valve for interim isolation.

Standard DTR

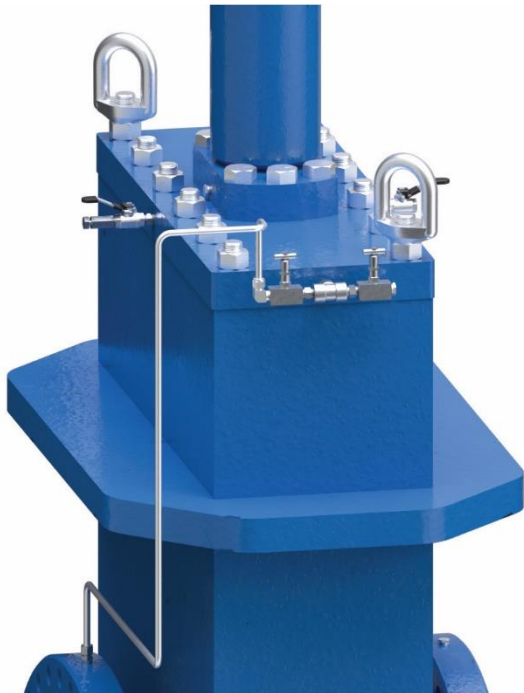

Optional Line Relieving DTR



Standard Differential Thermal Relief (DTR)

This configuration is acceptable for liquid service.

The BODY BLEED VALVE is for the purposes of manually venting the body cavity and seat integrity testing. When not being used for bleeding, the body bleed valve should be closed and the outlet should be plugged.

The UPSTREAM ISOLATION VALVE must be left open for cavity relief to function.

It should only be closed for maintenance and leakage management in the event of damage.

Directionality Characteristics of Valve Are Shown Below

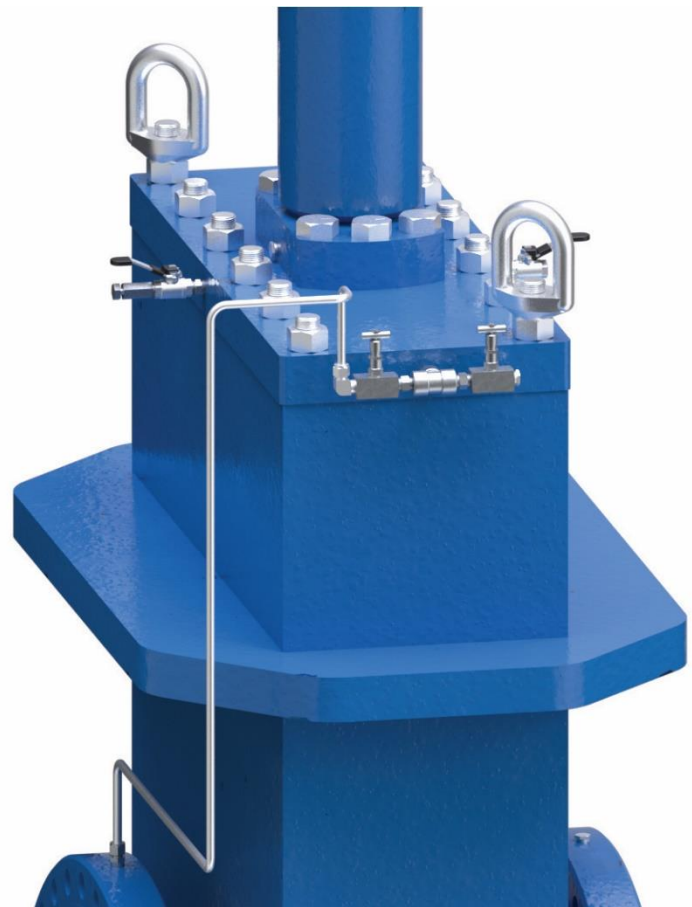
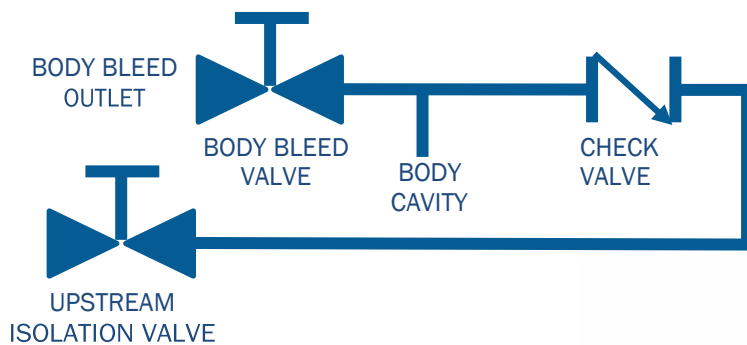



Optional Line Relieving Differential Thermal Relief (LRDTR)

This configuration may be used to relieve trapped piping downstream from the valve. The Downstream isolation valve must be closed for seat integrity confirmation. The body bleed valve should be closed and the outlet should be plugged, when not being used for bleeding.

Upstream and Downstream isolation valves must be left open for cavity relief function.

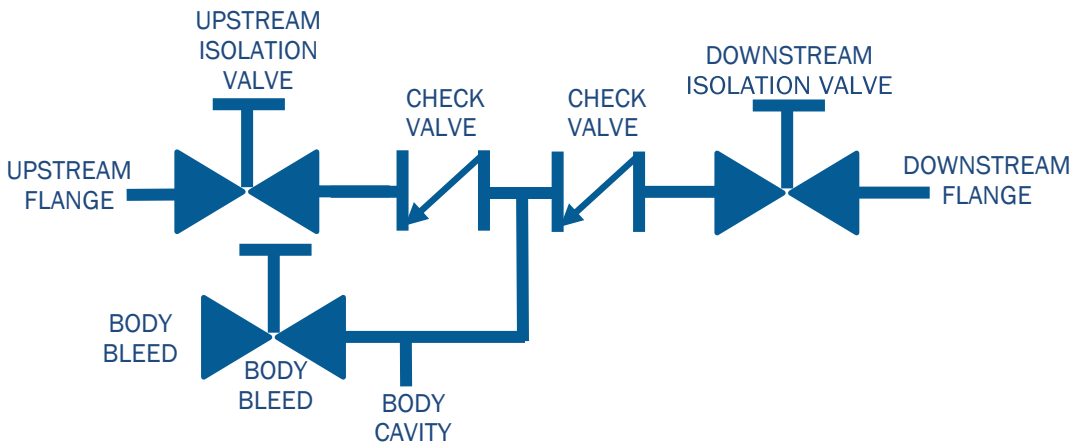
Directionality Characteristics of Valve Are Shown Below



 500 Northpark Central Dr. Suite 100 Houston, Texas 77073

 713.812.7100

 sales@franklinvalve.com

 www.franklinvalve.com

 www.linkedin.com/franklin-valve-lp

