

BABBITT LEVEL SWITCHES

**GUARANTEED
PERFORMANCE
& RELIABILITY**



LS 6000



LS 7000

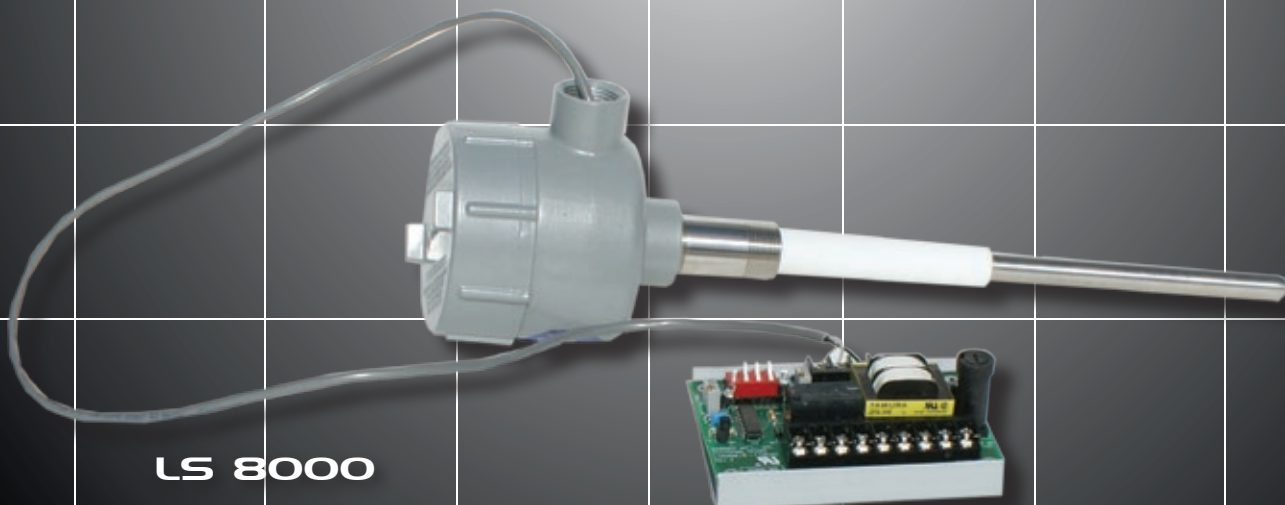

LS 8000

LS 6000 Level Switch

Low Cost, High Performance

The LS 6000 level switch is an excellent general purpose level control. This unit can sense all liquids and difficult to measure dry materials.

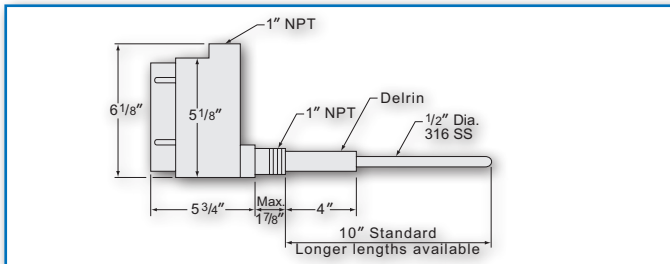

Like all Babbitt International level switches, the LS 6000 employs a radio frequency (RF) balanced impedance bridge to sense the presence or absence of products. This technique provides the ability to ignore significant product build-up on the probe and is very stable over wide temperature swings, thus eliminating the need for seasonal recalibration.

All electronics are housed in an explosion proof enclosure and all necessary calibration adjustments and indicators are on-board, so all you need to calibrate the LS 6000 is a small screwdriver.

The probe is very rugged and made of 1/2" diameter 316 stainless steel. If a probe is too long, just cut it off with a saw. Or, if you require a longer probe, simply weld on additional rods. Probes of all lengths are available from the factory.

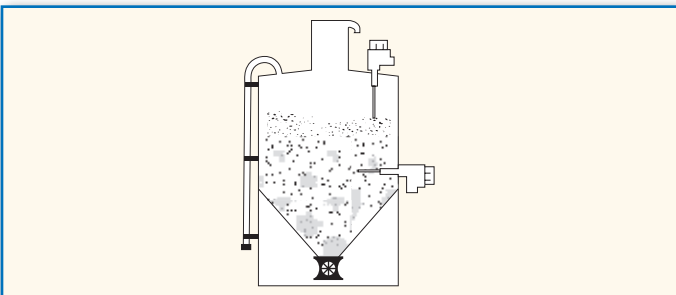

- Senses Liquid and Dry Materials
- Ignores Significant Product Build-up
- Simple Calibration
- Failsafe Electronics
- 5 AMP, DPDT Relay Output

LS 7000 Level Switch

Most Versatile Level Switch Available

The LS 7000 level switch has all the features and reliability of the LS 6000, plus features that make it the most versatile level control on the market today.

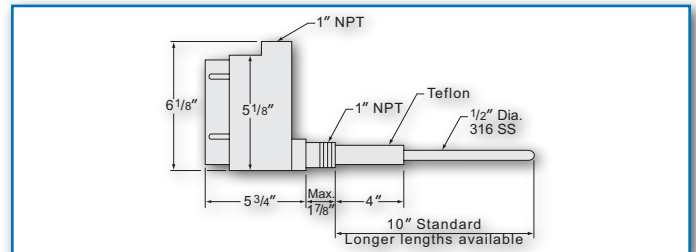

Every standard unit has an on-board fuse and surge suppressor to protect the electronics from improper supply voltages.

A built in static arrestor protects the circuitry from hostile bin environments created by static prone materials such as plastic pellets.

An on-board test switch combined with modular electronics makes troubleshooting and repair a snap. Of course, every unit is backed by our two year warranty.

The time delay allows the user to select ON DELAY or OFF DELAY operation. This timing range is adjustable from 1/8 second to 2 hours. The timer can be used to ignore wave action in a tank, or the timer can be used to pump down a sump with a single probe.

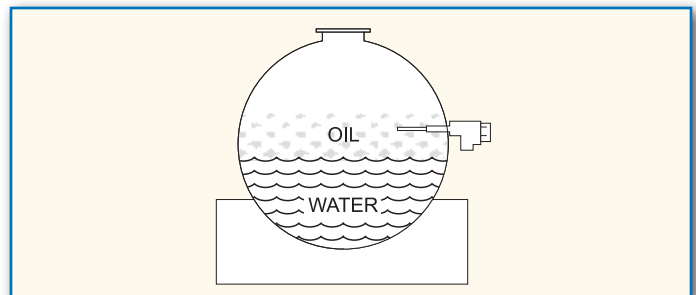

- User Programmable Time Delay
- On-Board Fuse and Spike Suppression
- Built-in Static Protection
- Failsafe High or Low Level
- On-Board Test Switch

LS 8000 Remote Mounted Level Switch

Remote Mount the Electronics up to One Mile from the Probe

The LS 8000 remote mounted level switch is the perfect choice when it is unsafe or inconvenient to mount the electronics directly to the probe.

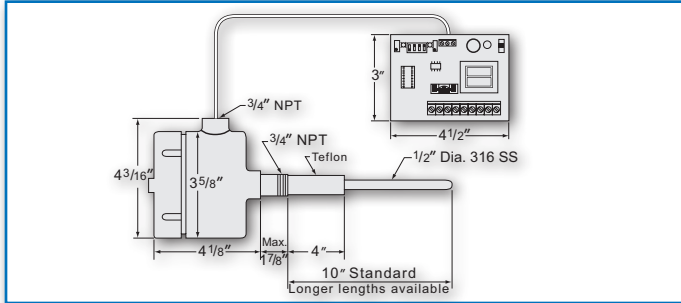

The probe consists of a maintenance free, epoxy encapsulated transmitter in an explosion proof housing. The transmitter is connected to a receiver with a twisted, shielded pair of wires (Belden 8761 or equal). The receiver board is wired to the supply voltage and has all the necessary calibration adjustments; failsafe and time delay adjustments, and the relay output.

It is possible to calibrate the LS 8000 without climbing a tall tank, or a probe can be located up to one mile from the nearest supply voltage.

The remote mounting does not sacrifice the reliability, stability or performance that makes Babbitt International level switches famous.

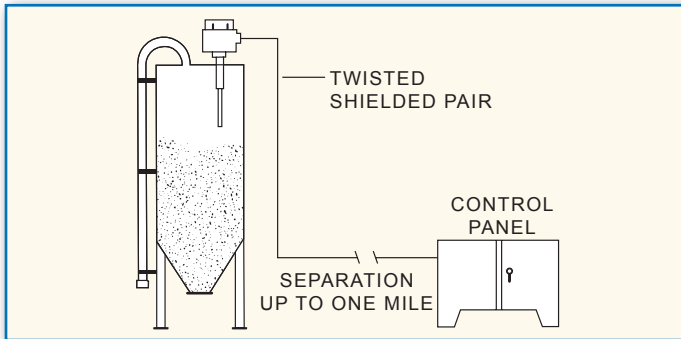

- Class I, Group C & D; Class II, Group E, F & G
- Inexpensive Interconnect Cable
- Failsafe High or Low Level
- Adjustable Time Delay
- Optional Enclosures for Receiver

Common Features

- Ignores significant product build-up
- Solid state, no moving parts
- Simple installation and calibration
- Modular electronics easily replaced
- Probe length easily field modified
- Explosion proof housing standard
- Rugged construction handles roughest products

Liquids

Wastewater
Oils
Acids
Slurries
Fuels
Caustics

Dry/Solids

Fly Ash
Cement
Plastics
Flour
Powders
Sand
Grains
Wood Chips

Interfaces

Oil/ Water
Foam/ Liquid

Applications

- High/Low Level Alarm
- Auto Tank Filling
- Dry pump protection
- Sump Controls
- Plugged Chute Protection

Optional Configurations Include

- Stainless Steel Enclosures
- Tri-Clamp Process Connections
- Flexible Cable Probes

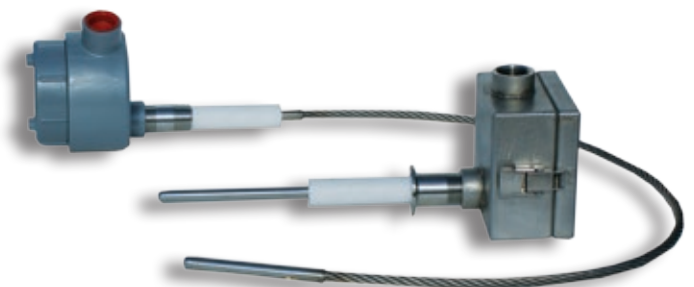

Specifications

ELECTRICAL	LS 6000	LS 7000	LS 8000
Power	115 VAC (+/- 15%), 50/60 HZ, 2 WATTS - STANDARD (12 VDC, 24 VDC, OR 230 VAC OPTIONAL)		
Output	2 FORM C Contacts, DPDT relay, 5 Amp Resistive @ 125, 230 VAC; 30 VDC		
On-Board Fuse	250mA	250mA	250mA
Selectable Failsafe	High or Low Level	High or Low Level	High or Low Level
Time Delay	N/A	Select: On or Off Delay Adj: 1/8 Sec - 2 Hrs	Select: On or Off Delay Adj: 1/8 Sec - 2 Hrs
MECHANICAL	LS 6000	LS 7000	LS 8000
Vessel Entry	1" NPT	1" NPT	3/4" NPT
Conduit Entry	1" NPT	1" NPT	3/4" NPT
Probe	1/2" Diameter 316 Stainless Steel Standard (Halar/ Other Coatings Optional)		
Insulator	Delrin	Teflon	Teflon
Housing	Explosion proof, Copper Free, Cast Aluminium		Transmitter: Explosion Proof Receiver: Track Mounted PC Optional Enclosures
ENVIRONMENTAL	LS 6000	LS 7000	LS 8000
Enclosure	Class I Group C,D Class II, Group E, F, G	Class I Group C,D Class II, Group E, F, G	Class I Group C, D; Class II, Group E, F, G
Temp: Electronics	-40°F to 185°	-40°F to 185°	-40°F to 185°
Temp: Probe	-30°F to 250°	-30°F to 450°	-30°F to 450°
Pressure: Probe	1" NPT 1500 PSI @ 75 F	1" NPT 1500 PSI @ 75 F	3/4" NPT 300 PSI @ 75 F
Special Materials of Construction Available		** All 3/4" Probes rated to 300 PSI @ 75 F	

Specifications Subject to Change Without Notice

ORDERING INFORMATION

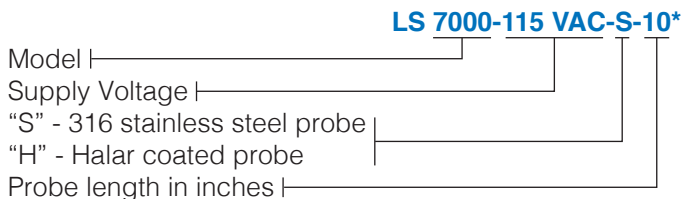

*This describes a LS 7000, powered by 115 VAC, with a 316 SS probe, 10" long. The probe length is measured from the end of the nipple to the tip of the probe.

BABBITT INTERNATIONAL, INC.

P.O. Box 70094
 Houston, Texas USA 77270
 Toll-Free: (800) 835-8012 • Local: (713) 467-4438

APPLICATION PERFORMANCE GUARANTEE If within 60 days of purchase, our product does not perform according to our claims and was properly installed in an approved application that does not exceed the stated performance specifications, the unit may be returned for full credit. © 2020 Babbitt International Inc. LS 4-Series 13A



www.babbittinternational.com