

# Rosemount™ 644H Temperature Transmitters

with FOUNDATION™ Fieldbus Protocol



---

## Contents

About this guide.....	3
Mount the transmitter.....	5
Wire and apply power.....	8
Ground the transmitter.....	11
Verify tagging.....	15
Verify transmitter configuration.....	16
Product certifications.....	18
Declaration of Conformity.....	36
China RoHS.....	40

# 1 About this guide

This guide provides basic guidelines for installing the Rosemount 644 Temperature Transmitter. It does not provide instructions for detailed configuration, diagnostics, maintenance, service, troubleshooting, or installation. Refer to the Rosemount 644 [Reference Manual](#) for more instruction. The manual and this guide are also available electronically on [Emerson.com/Rosemount](http://Emerson.com/Rosemount).

## Safety messages

### **⚠ WARNING**

**The products described in this document are NOT designed for nuclear-qualified applications.**

Using non-nuclear qualified products in applications that require nuclear-qualified hardware or products may cause inaccurate readings.

For information on Rosemount nuclear-qualified products, contact your local Emerson Sales Representative.

### **Follow instructions**

Failure to follow these installation guidelines could result in death or serious injury.

Ensure only qualified personnel perform the installation.

### **Physical access**

Unauthorized personnel may potentially cause significant damage to and/or misconfiguration of end users' equipment. This could be intentional or unintentional and needs to be protected against.

Physical security is an important part of any security program and fundamental to protecting your system. Restrict physical access by unauthorized personnel to protect end users' assets. This is true for all systems used within the facility.

---

**⚠ WARNING****Explosions**

Explosions could result in death or serious injury.

Installation of the transmitters in a hazardous environment must be in accordance with the appropriate local, national, and international standards, codes, and practices. Please review the Product Certifications section for any restrictions associated with a safe installation.

Do not remove the connection head cover in explosive atmospheres when the circuit is live.

Before connecting a handheld communicator in an explosive atmosphere, ensure the instruments are installed in accordance with intrinsically safe or non-incendive field wiring practices. Verify the operating atmosphere of the transmitter is consistent with the appropriate hazardous locations certifications.

All connection head covers must be fully engaged to meet explosion-proof requirements.

**Process leaks**

Process leaks could result in death or serious injury.

Do not remove the thermowell while in operation.

Install and tighten thermowells and sensors before applying pressure.

**Electrical shock**

Electrical shock could cause death or serious injury.

Avoid contact with the leads and terminals. High voltage that may be present on leads can cause electrical shock.

**⚠ CAUTION****Conduit/cable entries**

Unless otherwise marked, the conduit/cable entries in the housing enclosure use a ½–14 NPT form. Only use plugs, adapters, glands, or conduit with a compatible thread form when closing these entries.

Entries marked "M20" are M20 x 1.5 thread form.

When installing in a hazardous location, use only appropriately listed or Ex certified plugs, glands, or adapters in cable/conduit entries.

## 2 Mount the transmitter

Mount the transmitter at a high point in the conduit run to prevent moisture from draining into the transmitter housing.

### 2.1 Install connection head

Head mount transmitter with DIN plate style sensor.

#### Prerequisites

#### **⚠ WARNING**

#### Enclosure

Enclosure covers must be fully engaged to meet explosion-proof requirements.

#### Procedure

1. Attach the thermowell to the pipe or process container wall. Install and tighten the thermowell before applying process pressure.
2. Assemble the transmitter to the sensor. Push the transmitter mounting screws through the sensor mounting plate and insert the snap rings (optional) into the transmitter mounting screw groove.
3. Wire the sensor to the transmitter.
4. Insert the transmitter-sensor assembly into the connection head. Thread the transmitter mounting screws into the connection head mounting holes. Assemble the extension to the connection head. Insert the assembly into the thermowell.
5. Slip the shielded cable through the cable gland.
6. Attach the cable gland into the shielded cable.
7. Insert the shielded cable leads into the connection head through the cable entry. Connect and tighten the cable gland.
8. Connect the shielded power cable leads to the transmitter power terminals.  
Avoid contact with sensor leads and sensor connections.
9. Install and tighten the connection head cover.

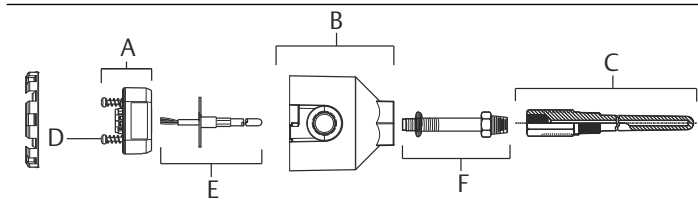

- A. Rosemount 644 Transmitter
- B. Connection head
- C. Thermowell
- D. Transmitter mounting screws
- E. Integral mount sensor with flying leads
- F. Extension

## 2.2 Install universal head

Head mount transmitter with threaded sensor.

### Prerequisites

#### **⚠ WARNING**

### Enclosure

Enclosure covers must be fully engaged to meet explosion-proof requirements.

### Procedure

1. Attach the thermowell to the pipe or process container wall. Install and tighten thermowells before applying process pressure.
2. Attach necessary extension nipples and adapters to the thermowell. Seal the nipple and adapter threads with silicone tape.
3. Screw the sensor into the thermowell. Install drain seals if required for severe environments or to satisfy code requirements.
4. Verify the correct installation of Integral Transient Protection (option code T1).
  - a) Ensure the transient protector unit is firmly connected to the transmitter puck assembly.
  - b) Ensure the transient protector power leads are adequately secured under the transmitter power terminal screws.
  - c) Verify the transient protector's ground wire is secured to the internal ground screw found within the universal head.

**Note**

The transient protector requires the use of an enclosure of at least 3.5-in. (89 mm) in diameter.

5. Pull the sensor wiring leads through the universal head and transmitter. Mount the transmitter in the universal head by threading the transmitter mounting screws into the universal head mounting holes.
6. Mount the transmitter-sensor assembly into the thermowell. Seal adapter threads with silicone tape.
7. Install conduit for field wiring to the conduit entry of the universal head. Seal conduit threads with PTFE tape.
8. Pull the field wiring leads through the conduit into the universal head. Attach the sensor and power leads to the transmitter. Avoid contact with other terminals.
9. Install and tighten the universal head cover.

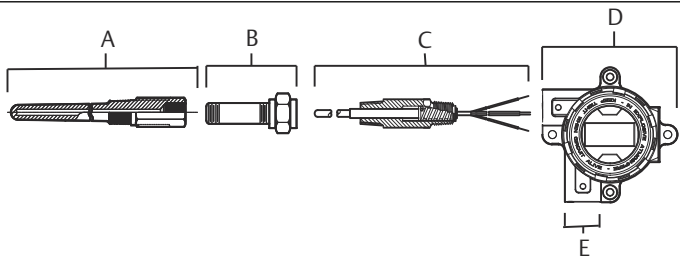

- A. Threaded thermowell
- B. Standard extension
- C. Threaded style sensor
- D. Universal head (transmitter and LCD inside)
- E. Conduit entry

## 3 Wire and apply power

Wiring diagrams are located inside the terminal block cover.

An external power supply is required to power a Fieldbus segment.

The power required across the transmitter power terminals is 9 to 32 Vdc (the power terminals are rated to 32 Vdc). To prevent damaging the transmitter, do not allow terminal voltage to drop below 9 Vdc when changing the configuration parameters.

### 3.1 Power filter

A Fieldbus segment requires a power conditioner to isolate the power supply filter and decouple the segment from other segments attached to the same power supply.

### 3.2 Power the transmitter

#### Procedure

1. Remove the terminal block cover (if applicable).
2. Connect the power lead to the power terminals.

The Rosemount 644 with FOUNDATION Fieldbus is polarity insensitive.

If a transient protector is being used, the power leads will now be connected to the top of the transient protector unit.

3. Tighten the terminal screws.

When tightening the sensor and power wires, the max torque is 6 in-lb (0.7 N-m).

4. Reattach and tighten the cover (if applicable).



5. Apply power (9–32 Vdc).

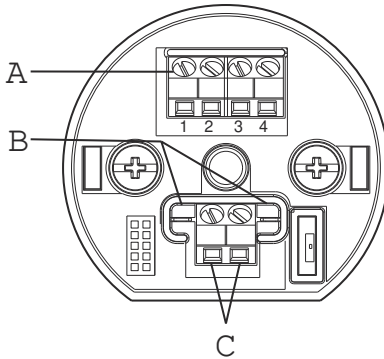

- A. Sensor terminals
- B. Communication terminals
- C. Power terminals

**Figure 3-1: Sensor Connections**

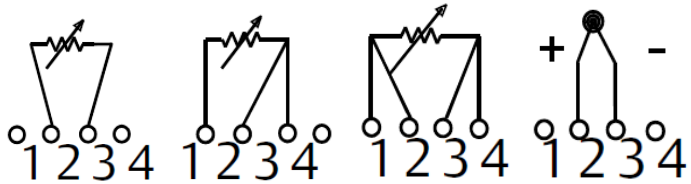

Two-wire RTD and  $\Omega$

Three-wire RTD<sup>(1)</sup> and  $\Omega$

Four-wire RTD<sup>(2)</sup> and  $\Omega$

T/C and mV

- (1) Emerson provides four-wire sensors for all single element RTDs. Use these RTDs in three-wire configurations by leaving the unneeded leads disconnected and insulated with electrical tape.
- (2) The transmitters must be configured for at least a three-wire RTD in order to recognize an RTD with a compensation loop.

**Figure 3-2: Typical Configuration for Fieldbus Networking**

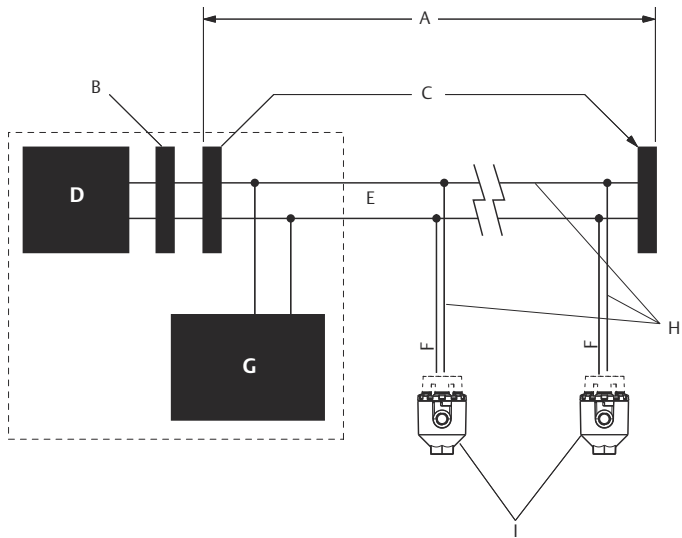

- A. 6234 ft. (1900 m) max, depending upon cable characteristics
- B. Integrated power conditioner and filter
- C. Terminators
- D. Power supply
- E. Trunk
- F. Spur
- G. FOUNDATION Fieldbus configuration tool
- H. Devices 1 through 16
- I. Power/signal wiring

**Note**

The power supply, filter, first terminator, and configuration tool are typically located in the control room.

**Note**

Each segment in a Fieldbus trunk must be terminated at both ends.

## 4 Ground the transmitter

### 4.1 Ungrounded thermocouple, mV, and RTD/Ohm inputs

Each process installation has different requirements for grounding. Use the grounding options recommended by the facility for the specific sensor type, or begin with grounding option 1 (the most common).

#### 4.1.1 Ground the transmitter: option 1

##### Procedure

1. Connect sensor wiring shield to the transmitter housing.
2. Ensure the sensor shield is electrically isolated from surrounding fixtures that may be grounded.
3. Ground signal wiring shield at the power supply end.

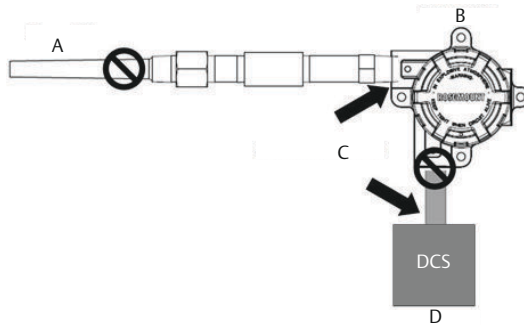

- A. Sensor wires
- B. Transmitter
- C. Shield ground point
- D. 4-20 mA loop

## 4.1.2 Ground the transmitter: option 2

### Procedure

1. Connect signal wiring shield to the sensor wiring shield.
2. Ensure the two shields are tied together and electrically isolated from the transmitter housing.
3. Ground shield at the power supply end only.
4. Ensure the sensor shield is electrically isolated from the surrounding grounded fixtures.

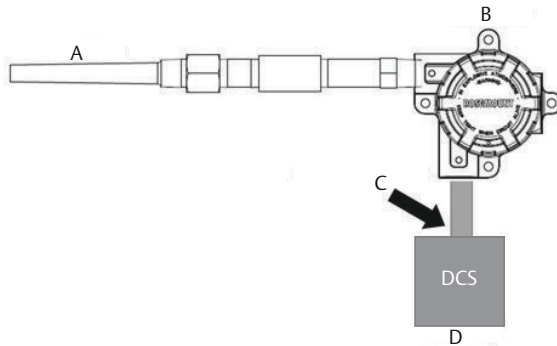

- A. Sensor wires
- B. Transmitter
- C. Shield ground point
- D. 4-20 mA loop

### Note

Connect shields together, electrically isolated from the transmitter.

### 4.1.3 Ground the transmitter: option 3

#### Procedure

1. Ground sensor wiring shield at the sensor if possible.
2. Ensure the sensor wiring and signal wiring shields are electrically isolated from the transmitter housing.
3. Do not connect the signal wiring shield to the sensor wiring shield.
4. Ground the signal wiring shield at the power supply end.

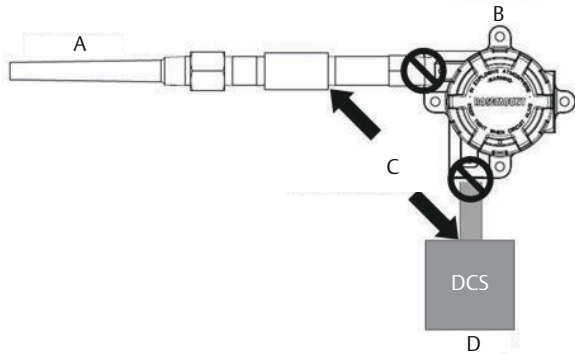

- A. Sensor wires
- B. Transmitter
- C. Shield ground point
- D. 4-20 mA loop

## 4.2 Grounded thermocouple inputs

### 4.2.1 Ground the transmitter: option 4

#### Procedure

1. Ground sensor wiring shield at the sensor.
2. Ensure the sensor wiring and signal wiring shields are electrically isolated from the transmitter housing.
3. Do not connect the signal wiring shield to the sensor wiring shield.
4. Ground signal wiring shield at the power supply end.

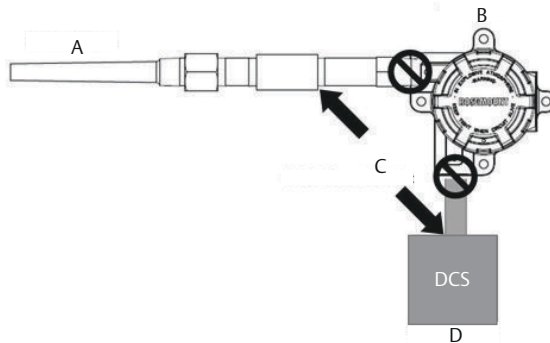

- A. Sensor wires
- B. Transmitter
- C. Shield ground point
- D. 4–20 mA loop

## 5 Verify tagging

### 5.1 Commissioning (paper) tag

To identify which device is at a particular location use the removable tag provided with the transmitter. Ensure the physical device tag (PD Tag field) is properly entered in both places on the removable commissioning tag and tear off the bottom portion for each transmitter.

COMMISSIONING TAG

Device ID:  
0011513051010001440-121698091725

PD Tag:  
TT-101

Revision: 7.2

— — — **Tear Here** — — —

Revision: 7.2

Support files available at  
[www.rosemount.com](http://www.rosemount.com)

Device Serial  
Number:  
XXXXXXXXXX

Device ID:  
0011513051010001440-121698091725

PD Tag:  
TT-101

---

#### Note

The device description loaded in the host system must be at the same revision as this device. You can download the device description from [Emerson.com/Rosemount](http://Emerson.com/Rosemount).

---

## 6 Verify transmitter configuration

Each FOUNDATION Fieldbus host or configuration tool has a different way of displaying and performing configurations. Some use Device Descriptions (DD) or DD methods for configuration and to display data consistently across platforms. There is no requirement that a host or configuration tool support these features.

The following is the minimum configuration requirement for a temperature measurement. This guide is designed for systems not using DD methods. For a complete list of parameters and configuration information refer to the Rosemount 644 Head and Rail Mount Temperature Transmitter [Reference Manual](#).

### 6.1 Transducer function block

This block contains temperature measurement data for the sensors and the terminal temperature. It also includes information about sensor types, engineering units, damping, and diagnostics.

At a minimum, verify the parameters in [Table 6-1](#).

**Table 6-1: Transducer Block Parameters**

Parameter	Comments
<b>Typical configuration</b>	
SENSOR_TYPE	Example: "Pt 100_A_385 (IEC 751)"
SENSOR_CONNECTIONS	Example: "2-wire", "3-wire", "4-wire"
<b>Sensor matching configuration</b>	
SENSOR_TYPE	"User Defined, Calvandu"
SENSOR_CONNECTIONS	Example: "2-wire", "3-wire", "4-wire"
SENSOR_CAL_METHOD	Set to "User Trim Standard"
SPECIAL_SENSOR_A	Enter sensor specific coefficients
SPECIAL_SENSOR_B	Enter sensor specific coefficients
SPECIAL_SENSOR_C	Enter sensor specific coefficients
SPECIAL_SENSOR_R0	Enter sensor specific coefficients

### 6.2 Analog Input (AI) function block

The AI block processes field device measurements and makes the outputs available to other function blocks. The output value of the AI block is in engineering units and contains a status indicating the quality of the



measurements. Use the channel number to define the variable that the AI block processes.

At a minimum, verify the parameters of each AI block in [Table 6-2](#).

**Table 6-2: AI Block Parameters**

Configure one AI Block for each desired measurement.

Parameter	Comments
CHANNEL	Choices: <ol style="list-style-type: none"> <li>1. Sensor 1</li> <li>2. Housing Temperature</li> </ol>
LIN_TYPE	This parameter defines the relationship between the block input and the block output. Since the transmitter does not require linearization, this parameter will always be set to No Linearization. This means that the AI block will only apply scaling, filtering, and limit checking to the input value.
XD_SCALE	Set desired measurement range and units. Units must be one of the following: <ul style="list-style-type: none"> <li>• mV</li> <li>• Ohms</li> <li>• °C</li> <li>• °F</li> <li>• °R</li> <li>• K</li> </ul>
OUT_SCALE	For “DIRECT” L_TYPE, set OUT_SCALE to match XD_SCALE
HI_HI_LIM HI_LIM LO_LIM LO_LO_LIM	Process alarms. Must be within the range defined by “OUT_SCALE”

---

**Note**

To make changes to the AI block, set the BLOCK\_MODE (TARGET) to OOS (out of service). After making the changes, return the BLOCK\_MODE TARGET to AUTO.

---

## 7 Product certifications

Rev 4.4

### 7.1 European Directive Information

A copy of the EU Declaration of Conformity can be found at the end of the Quick Start Guide. The most recent revision of the EU Declaration of Conformity can be found at [Emerson.com/Rosemount](http://Emerson.com/Rosemount).

### 7.2 Ordinary Location Certification

As standard, the transmitter has been examined and tested to determine that the design meets the basic electrical, mechanical, and fire protection requirements by a nationally recognized test laboratory (NRTL) as accredited by the Federal Occupational Safety and Health Administration (OSHA).

### 7.3 North America

The US National Electrical Code® (NEC) and the Canadian Electrical Code (CEC) permit the use of Division marked equipment in Zones and Zone marked equipment in Divisions. The markings must be suitable for the area classification, gas, and temperature class. This information is clearly defined in the respective codes.

### 7.4 USA

#### 7.4.1 E5 USA Explosionproof, Non-Incendive, Dust-Ignitionproof

**Certificate:** 1091070

**Standards:** FM Class 3600: 2011, FM Class 3615: 2006, FM Class 3616: 2011, ANSI/ISA 60079-0: Ed. 5, UL Std. No. 50E, CAN/CSA C22.2 No. 60529-05

**Markings:** XP CL I, DIV 1, GP B, C, D; DIP CL II / III, DIV 1, GPE, F, G; T5(-50 °C ≤ T<sub>a</sub> ≤ +85 °C); Type 4X; IP66; See I5 description for Non-Incendive markings.

#### 7.4.2 I5 USA Intrinsic Safety and Non-Incendive

**Certificate:** 1091070

**Standards:** FM Class 3600: 2011, FM Class 3610: 2010, FM Class 3611: 2004, ANSI/ISA 60079-0: Ed. 5, UL Std. No. 60079-11: Ed. 6, UL Std. No. 50E, CAN/CSA C22.2 No. 60529-05

**Markings:** IS CL I/II/III, DIV I, GP A, B, C, D, E, F, G; CL I ZONE 0 AEx ia IIC; NI CL I, DIV 2, GP A, B, C, D

### Special Conditions for Safe Use (X):

1. When no enclosure option is selected, the Rosemount 644 Temperature Transmitter shall be installed in a final enclosure meeting type of protection IP20 and meeting the requirements of ANSI/ISA 61010-1 and ANSI/ISA 60079-0.
2. Option code K5 is only applicable with a Rosemount enclosure. However, K5 is not valid with enclosure options S1, S2, S3, or S4.
3. An enclosure option must be selected to maintain a Type 4X rating.
4. The Rosemount 644 Transmitter optional housings may contain aluminum and is considered a potential risk of ignition by impact or friction. Care must be taken during installation and use to prevent impact and friction.

## 7.5 Canada

### 7.5.1 I6 Canada Intrinsic Safety and Division 2

**Certificate:** 1091070

**Standards:** CAN/CSA C22.2 No. 0-10, CSA Std C22.2 No. 25-1966, CAN/CSA-C22.2 No. 94-M91, CSA Std C22.2 No. 142-M1987, CAN/CSA-C22.2 No. 157-92, CSA Std C22.2 No. 213-M1987, C22.2 No 60529-05, CAN/CSA C22.2 No. 60079-0:11, CAN/CSA C22.2 No. 60079-11:14, CAN/CSA Std. No. 61010-1-12

**Markings:** [HART] IS CL I GP A, B, C, D T4/T6; CL I, DIV 2, GP A, B, C, D  
[Fieldbus/PROFIBUS] IS CL I GP A, B, C, D T4; CL I, ZONE 0 IIC; CL I, DIV 2, GP A, B, C, D

### 7.5.2 K6 Canada Explosionproof, Dust-Ignitionproof, Intrinsic Safety and Division 2

**Certificate:** 1091070

**Standards:** CAN/CSA C22.2 No. 0-10, CSA Std C22.2 No. 25-1966, CSA Std. C22.2 No. 30-M1986, CAN/CSA-C22.2 No. 94-M91, CSA Std C22.2 No. 142-M1987, CAN/CSA-C22.2 No. 157-92, CSA Std C22.2 No. 213-M1987, C22.2 No 60529-05, CAN/CSA C22.2 No. 60079-0:11, CAN/CSA C22.2 No. 60079-11:14, CAN/CSA Std. No. 61010-1-12

**Markings:** CL I/II/III, DIV 1, GP B, C, D, E, F, G  
See I6 description for Intrinsic Safety and Division 2 markings

## 7.6 Europe

### 7.6.1 E1 ATEX Flameproof

**Certificate:** FM12ATEX0065X

**Standards:** EN 60079-0: 2012+A11:2013, EN 60079-1: 2014, EN 60529:1991 +A1:2000+A2:2013

**Markings:** Ⓢ II 2 G Ex db IIC T6...T1 Gb, T6(-50 °C ≤ T<sub>a</sub> ≤ +40 °C), T5... T1(-50 °C ≤ T<sub>a</sub> ≤ +60 °C)

See [Table 7-1](#) for process temperatures.

#### Special Conditions for Safe Use (X):

1. See certificate for ambient temperature range.
2. The non-metallic label may store an electrostatic charge and become a source of ignition in Group III environments.
3. Guard the LCD display cover against impact energies greater than 4 joules.
4. Flameproof joints are not intended for repair.
5. A suitable certified Ex d or Ex tb enclosure is required to be connected to temperature probes with Enclosure option "N".
6. Care shall be taken by the end user to ensure that the external surface temperature on the equipment and the neck of DIN Style Sensor probe does not exceed 130 °C.
7. Non-Standard Paint options may cause risk from electrostatic discharge. Avoid installations that cause electrostatic build-up on painted surfaces, and only clean the painted surfaces with a damp cloth. If paint is ordered through a special option code, contact the manufacturer for more information.

### 7.6.2 I1 ATEX Intrinsic Safety

**Certificate:** [Headmount HART]: Baseefa12ATEX0101X  
 [Headmount Fieldbus/PROFIBUS]: Baseefa03ATEX0499X  
 [Railmount HART]: BAS00ATEX1033X



**Standards:** EN IEC 60079-0: 2018, EN 60079-11: 2012

**Markings:** [HART]: Ⓢ II 1 G Ex ia IIC T6...T4 Ga  
 [Fieldbus/PROFIBUS]: Ⓢ II 1 G Ex ia IIC T4 Ga

See [Table 7-5](#) for entity parameters and temperature classifications.

**Special Conditions for Safe Use (X):**

1. The equipment must be installed in an enclosure which affords it a degree of protection of at least IP20 in accordance with the requirements of IEC 60529. Non-metallic enclosures must have a surface resistance of less than  $1\text{ G } \Omega$ ; light alloy or zirconium enclosures must be protected from impact and friction when installed in a Zone 0 environment.
2. When fitted with the Transient Protector Assembly, the equipment is not capable of withstanding the 500 V test as defined in Clause 6.3.13 of EN 60079-11:2012. This must be taken into account during installation.

**7.6.3 N1 ATEX Type n – with enclosure****Certificate:** BAS00ATEX3145**Standards:** EN 60079-0: 2012+A11: 2013, EN 60079-15: 2010**Markings:**  II 3 G Ex nA IIC T5 Gc ( $-40\text{ }^{\circ}\text{C} \leq T_a \leq +70\text{ }^{\circ}\text{C}$ )**7.6.4 NC ATEX Type n – without enclosure****Certificate:** [Headmount Fieldbus/PROFIBUS, Railmount HART]:  
Baseefa13ATEX0093X  
[Headmount HART]: Baseefa12ATEX0102U**Standards:** EN IEC 60079-0: 2018, EN 60079-15: 2010**Markings:** [Headmount Fieldbus/PROFIBUS, Railmount HART]:  II 3 G  
Ex nA IIC T5 Gc ( $-40\text{ }^{\circ}\text{C} \leq T_a \leq +70\text{ }^{\circ}\text{C}$ )  
[Headmount HART]:  II 3 G Ex nA IIC T6...T5 Gc; T6( $-60\text{ }^{\circ}\text{C} \leq T_a \leq +40\text{ }^{\circ}\text{C}$ ); T5( $-60\text{ }^{\circ}\text{C} \leq T_a \leq +85\text{ }^{\circ}\text{C}$ )**Special Conditions for Safe Use (X):**

1. The Rosemount 644 Temperature Transmitter must be installed in a suitably certified enclosure such that it is afforded a degree of protection of at least IP54 in accordance with IEC 60529 and EN 60079-15.
2. When fitted with the Transient Protector Assembly, the equipment is not capable of withstanding the 500 V test as defined in Clause 6.5 of EN 60079-15: 2010. This must be taken into account during installation.

## 7.6.5 ND ATEX Dust

**Certificate:** FM12ATEX0065X

**Standards:** EN 60079-0: 2012+A11:2013, EN 60079-31: 2014, EN 60529:1991 +A1:2000

**Markings:**  II 2 D Ex tb IIIC T130 °C Db, ( $-40\text{ °C} \leq T_a \leq +70\text{ °C}$ ); IP66  
See [Table 7-1](#) for process temperatures.

### Special Conditions for Safe Use (X):

1. See certificate for ambient temperature range.
2. The non-metallic label may store an electrostatic charge and become a source of ignition in Group III environments.
3. Guard the LCD display cover against impact energies greater than 4 joules.
4. Flameproof joints are not intended for repair.
5. A suitable certified Ex d or Ex tb enclosure is required to be connected to temperature probes with Enclosure option "N".
6. Care shall be taken by the end user to ensure that the external surface temperature on the equipment and the neck of DIN Style Sensor probe does not exceed 130 °C.
7. Non-Standard Paint options may cause risk from electrostatic discharge. Avoid installations that cause electrostatic build-up on painted surfaces, and only clean the painted surfaces with a damp cloth. If paint is ordered through a special option code, contact the manufacturer for more information

## 7.7 International

### 7.7.1 E7 IECEx Flameproof

**Certificate:** IECEx FMG 12.0022X

**Standards:** IEC 60079-0: 2011, IEC 60079-1: 2014

**Markings:** Ex db IIC T6...T1 Gb, T6( $-50\text{ °C} \leq T_a \leq +40\text{ °C}$ ), T5...T1( $-50\text{ °C} \leq T_a \leq +60\text{ °C}$ )

See [Table 7-1](#) for process temperatures.

### Special Conditions for Safe Use (X):

1. See certificate for ambient temperature range.
2. The non-metallic label may store an electrostatic charge and become a source of ignition in Group III environments.

3. Guard the LCD display cover against impact energies greater than 4 joules.
4. Flameproof joints are not intended for repair.
5. A suitable certified Ex d or Ex tb enclosure is required to be connected to temperature probes with Enclosure option “N”.
6. Care shall be taken by the end user to ensure that the external surface temperature on the equipment and the neck of DIN Style Sensor probe does not exceed 130 °C.
7. Non-Standard Paint options may cause risk from electrostatic discharge. Avoid installations that cause electrostatic build-up on painted surfaces, and only clean the painted surfaces with a damp cloth. If paint is ordered through a special option code, contact the manufacturer for more information.

### 7.7.2 I7 IECEx Intrinsic Safety

**Certificate:** [Headmount HART]: IECEx BAS 12.0069X

[Headmount Fieldbus/PROFIBUS, Railmount HART]: IECEx BAS 07.0053X

**Standards:** IEC 60079-0: 2017, IEC 60079-11: 2011

**Markings:** Ex ia IIC T6...T4 Ga

See [Table 7-5](#) for Entity Parameters and Temperature Classifications.

#### Special Conditions for Safe Use (X):

1. The equipment must be installed in an enclosure which affords it a degree of protection of at least IP20 in accordance with the requirements of IEC 60529. Non-metallic enclosures must have a surface resistance of less than 1G  $\Omega$ ; light alloy or zirconium enclosures must be protected from impact and friction when installed in a Zone 0 environment.
2. When fitted with the Transient Protector Assembly, the equipment is not capable of withstanding the 500 V test as defined in Clause 6.3.13 of IEC 60079-11:2011. This must be taken into account during installation.

### 7.7.3 N7 IECEx Type n – with enclosure

**Certificate:** IECEx BAS 07.0055

**Standards:** IEC 60079-0: 2011, IEC 60079-15: 2010

**Markings:** Ex nA IIC T5 Gc (-40 °C ≤ T<sub>a</sub> ≤ +70 °C)

### 7.7.4 NG IECEx Type n – without enclosure

**Certificate:** [Headmount Fieldbus/PROFIBUS, Railmount HART]: IECEx BAS 13.0053X

[Headmount HART]: IECEx BAS 12.0070U

**Standards:** IEC 60079-0: 2017, IEC 60079-15: 2010

**Markings:** [Headmount Fieldbus/PROFIBUS, Railmount HART]: Ex nA IIC T5 Gc ( $-40\text{ }^{\circ}\text{C} \leq T_a \leq +70\text{ }^{\circ}\text{C}$ )

[Headmount HART]: Ex nA IIC T6...T5 Gc; T6 ( $-60\text{ }^{\circ}\text{C} \leq T_a \leq +40\text{ }^{\circ}\text{C}$ ); T5 ( $-60\text{ }^{\circ}\text{C} \leq T_a \leq +85\text{ }^{\circ}\text{C}$ )

#### Special Conditions for Safe Use (X):

1. The Rosemount 644 Temperature Transmitter must be installed in a suitably certified enclosure such that it is afforded a degree of protection of at least IP54 in accordance with IEC 60529 and IEC 60079-15.
2. When fitted with the Transient Protector Assembly, the equipment is not capable of withstanding the 500 V test. This must be taken into account during installation.

### 7.7.5 NK IECEx Dust

**Certificate:** IECEx FMG 12.0022X

**Standards:** IEC 60079-0: 2011, IEC 60079-31: 2013

**Markings:** Ex tb IIIC T130 °C Db, ( $-40\text{ }^{\circ}\text{C} \leq T_a \leq +70\text{ }^{\circ}\text{C}$ ); IP66

See [Table 7-1](#) for process temperatures

#### Special Conditions for Safe Use (X):

1. See certificate for ambient temperature range.
2. The non-metallic label may store an electrostatic charge and become a source of ignition in Group III environments.
3. Guard the LCD display cover against impact energies greater than 4 joules.
4. Flameproof joints are not intended for repair.
5. A suitable certified Ex d or Ex tb enclosure is required to be connected to temperature probes with Enclosure option "N".
6. Care shall be taken by the end user to ensure that the external surface temperature on the equipment and the neck of DIN Style Sensor probe does not exceed 130 °C.



7. Non-Standard Paint options may cause risk from electrostatic discharge. Avoid installations that cause electrostatic build-up on painted surfaces, and only clean the painted surfaces with a damp cloth. If paint is ordered through a special option code, contact the manufacturer for more information.

## 7.8 Brazil

### 7.8.1 E2 INMETRO Flameproof and Dust

**Certificate:** UL-BR 13.0535X

**Standards:** ABNT NBR IEC 60079-0:2013, ABNT NBR IEC 60079-1:2016, ABNT NBR IEC 60079-31:2014

**Markings:** Ex db IIC T6...T1 Gb; T6...T1: ( $-50\text{ °C} \leq T_a \leq +40\text{ °C}$ ), T5...T1: ( $-50\text{ °C} \leq T_a \leq +60\text{ °C}$ )  
Ex tb IIIC T130 °C; IP66; ( $-40\text{ °C} \leq T_a \leq +70\text{ °C}$ )

#### Special Conditions for Safe Use (X):

1. See product description for ambient temperature limits and process temperature limits.
2. The non-metallic label may store an electrostatic charge and become a source of ignition in Group III environments.
3. Guard the LCD display cover against impact energies greater than 4 joules.
4. Consult the manufacturer if dimensional information on the flameproof joints is necessary.

### 7.8.2 I2 INMETRO Intrinsic Safety

**Certificate:** [Fieldbus]: UL-BR 15.0264X [HART]: UL-BR 14.0670X

**Standards:** ABNT NBR IEC 60079-0:2013, ABNT NBR IEC 60079-11:2013

**Markings:** [Fieldbus]: Ex ia IIC T\* Ga ( $-60\text{ °C} \leq T_a \leq +**\text{ °C}$ ) [HART]: Ex ia IIC T\* Ga ( $-60\text{ °C} \leq T_a \leq +**\text{ °C}$ )

See [Table 7-5](#) for Entity Parameters and Temperature Classifications.

#### Special Conditions for Safe Use (X):

1. The apparatus must be installed in an enclosure which affords it a degree of protection of at least IP20.
2. Non-metallic enclosures must have a surface resistance of less than 1 G  $\Omega$ ; light alloy or zirconium enclosures must be protected from impact and friction when installed in a zone 0 environment.

- When fitted with the Transient Protector Assembly, the equipment is not capable of withstanding the 500 V test as defined on ABNT NBR IEC 60079-11. This must be taken into account during installation.
- The ingress protection degree IP66 is provided only for the Rosemount 644 Field Mount Assembly which is formed by installing an Enhanced Model 644 Temperature Transmitter within a dual-compartment enclosure Plantweb enclosure.

## 7.9 China

### 7.9.1 E3 China Flameproof

**Certificate:** GYJ16.1192X

**Standards:** GB3836.1-2010, GB3836.2-2010, GB12476.1-2013, GB12476.5-2013

**Markings:** Ex d IIC T6...T1; Ex tD A21 T130 °C; IP66

#### 产品安全使用特定条件

产品防爆合格证后缀“X”代表产品安全使用有特定条件：

- 涉及隔爆接合面的维修须联系产品制造商。
- 产品铭牌材质为非金属，使用时须防止产生静电火花，只能用湿布清理。
- 产品使用环境温度与温度组别的关系为：

防爆标志	温度组别	环境温度
Ex d IIC T6~T1 Gb	T6 ~ T1	$-50^{\circ}\text{C} \leq T_a \leq +40^{\circ}\text{C}$
	T5 ~ T1	$-50^{\circ}\text{C} \leq T_a \leq +60^{\circ}\text{C}$
Ex Td A21 IP66 T130 °C	N/A	$-40^{\circ}\text{C} \leq T_a \leq +70^{\circ}\text{C}$

- 产品外壳设有接地端子，用户在安装使用时应可靠接地。
- 现场安装时，电缆引入口须选用国家指定的防爆检验机构按检验认可、具有 Ex d IIC, Ex tD A21 IP66 防爆等级的电缆引入装置或堵封件，冗余电缆引入口须用堵封件有效密封。
- 用于爆炸性气体环境中，现场安装、使用和维护必须严格遵守“断电后开盖！”的警告语。用于爆炸性粉尘环境中，现场安装、使用、和维护必须严格遵守“爆炸性粉尘场所严禁开盖！”的警告语。
- 用于爆炸性粉尘环境中，产品外壳表面须保持清洁，以防粉尘堆积，单严禁用压缩空气吹扫。

8. 产品的安装、使用和维护应同时遵守产品使用说明书、GB3836.13-2013“爆炸性环境 第 13 部分：设备的修理、检修、修复和改造”、GB3836.15-2000“爆炸性气体环境用电气设备 第 15 部分：危险场所电气安装（煤矿除外）”、GB3836.16-2006“爆炸性气体环境用电气设备 第 16 部分：电气装置的检查和维护（煤矿除外）”和 GB50257-2014“电气装置安装工程爆炸和火灾危险环境电力装置施工及验收规范”和 GB15577-2007“粉尘防爆安全规程”、GB12476.2-2010“可燃性粉尘环境用电气设备 第 2 部分 选型和安装”的有关规定。

## 7.9.2 I3 China Intrinsic Safety

**Certificate:** GYJ16.1191X

**Standards:** GB3836.1-2010, GB3836.4-2010, GB3836.20-2010

**Markings:** Ex ia IIC T4~T6 Ga

### 产品安全使用特殊条件

防爆合格证号后缀“X”代表产品安全使用有特定条件：

1. 温度变送器须安装于外壳防护等级不低于国家标准 GB/T4208-2017 规定的 IP20 的壳体中，方可用于爆炸性危险场所，金属壳体须符合国家标准 GB3836.1-2010 第 8 条的规定，非金属壳体须符合 GB3836.1-2010 第 7.4 条的规定。
2. 非金属外壳表面电阻必须小于  $1G\Omega$ ，轻金属或者铝外壳在安装时必须防止冲击和摩擦。
3. 当 Transmitter Type 为 F、D 时，产品外壳含有轻金属，用于 0 区时需注意防止由于冲击或摩擦产生的点燃危险。
4. 产品选用瞬态保护端子板（选项代码为 T1）时，此设备不能承受 GB3836.4-2010 标准中第 6.3.12 条规定的 500V 交流有效值试验电压的介电强度试验。

### 产品使用注意事项

1. 产品环境温度为：  
当 Options 不选择 Enhanced Performance 时

输出代码	最大输出功率 ( W )	温度组别	环境温度
A	0.67	T6	$-60^{\circ}\text{C} \leq T_a \leq +40^{\circ}\text{C}$
	0.67	T5	$-60^{\circ}\text{C} \leq T_a \leq +50^{\circ}\text{C}$
	1	T5	$-60^{\circ}\text{C} \leq T_a \leq +40^{\circ}\text{C}$
	1	T4	$-60^{\circ}\text{C} \leq T_a \leq +80^{\circ}\text{C}$
F 或 W	1.3	T4	$-50^{\circ}\text{C} \leq T_a \leq +60^{\circ}\text{C}$

输出代码	最大输出功率 ( W )	温度组别	环境温度
	5.32	T4	$-50^{\circ}\text{C} \leq T_a \leq +60^{\circ}\text{C}$

当 Options 选择 Enhanced Performance 时

最大输出功率 ( W )	温度组别	环境温度
0.67	T6	$-60^{\circ}\text{C} \leq T_a \leq +40^{\circ}\text{C}$
0.67	T5	$-60^{\circ}\text{C} \leq T_a \leq +50^{\circ}\text{C}$
0.80	T5	$-60^{\circ}\text{C} \leq T_a \leq +40^{\circ}\text{C}$
0.80	T4	$-60^{\circ}\text{C} \leq T_a \leq +80^{\circ}\text{C}$

## 2. 参数 :

当 Options 不选择 Enhanced Performance 时  
输入端(+, -)

输出代码	最高输入电压 $U_i$ ( V )	最大输入电流 $I_i$ ( mA )	最大输入功率 $P_i$ ( W )	最大内部等效参数	
				$C_i$ (nF)	$L_i$ (mH)
A	30	200	0.67/1	10	0
F 或 W	30	300	1.3	2.1	0
F 或 W(FISCO)	17.5	380	5.32	2.1	0

传感器端 ( 1,2,3,4 )

输出代码	最高输出电压 $U_o$ (V)	最大输出电流 $I_o$ (mA)	最大输出功率 $P_o$ (W)	最大内部等效参数	
				$C_o$ (nF)	$L_o$ (mH)
A	13.6	80	0.08	75	0
F,W	13.9	23	0.079	7.7	0

当 Options 选择 Enhanced Performance 时  
输入端(+, -)

最高输入电压 $U_i$ (V)	最大输入电流 $I_i$ (mA)	最大输入功率 $P_i$ (W)	最大内部等效参数	
			$C_i$ (nF)	$L_i$ (mH)
30	150 ( $T_a \leq +80^{\circ}\text{C}$ )	0.67/0.8	3.3	0
	170 ( $T_a \leq +70^{\circ}\text{C}$ )			

最高输入电压 $U_i$ (V)	最大输入电流 $I_i$ (mA)	最大输入功率 $P_i$ (W)	最大内部等效参数	
			$C_i$ (nF)	$L_i$ (mH)
	190 ( $T_a \leq +60^\circ\text{C}$ )			

传感器端 ( 1,2,3,4 )

最高输出电压 $U_o$ (V)	最大输出电流 $I_o$ (mA)	最大输出功率 $P_o$ (W)	组别	最大内部等效参数	
				$C_o$ (nF)	$L_o$ (mH)
13.6	80	0.08	IIC	0.816	5.79
			IIB	5.196	23.4
			IIA	18.596	48.06

注：本案电气参数符合 GB3836.19-2010 对 FISCO 现场仪表的参数要求。

3. 该产品必须与已通过防爆认证的关联设备配套共同组成本安防爆系统方可用于爆炸性气体环境。其系统接线必须同时遵守本产品 and 所配关联设备的使用说明书要求，接线端子不得接错。
4. 用户不得自行更换该产品的零部件，应会同产品制造商共同解决运行中出现的故障，以杜绝损坏现象的发生。
5. 产品的安装、使用和维护应同时遵守产品使用说明书、GB3836.13-2013“爆炸性环境 第 13 部分：设备的修理、检修、修复和改造”、GB/T3836.15-2017“爆炸性环境 第 15 部分：电气装置的设计，选型和安装”、GB/T3836.16-2017“爆炸性环境 第 16 部分：电气装置的检查和维护”、GB/T3836.18-2017“爆炸性环境 第 18 部分：本质安全电气系统”和 GB50257-2014“电气装置安装工程爆炸和火灾危险环境电力装置施工及验收规范”的有关规定。

### 7.9.3 N3 China Type n

**Certificate:** GYJ15.1502

**Standards:** GB3836.1-2010, GB3836.8-2014

**Markings:** Ex nA IIC T5/T6 Gc

#### 产品安全使用特殊条件

1. 产品温度组别和使用环境温度范围之间的关系为：  
当 Options 不选择 Enhanced Performance 时：

温度组别	环境温度
T5	$-40^\circ\text{C} \leq T_a \leq +70^\circ\text{C}$

当 Options 选择 Enhanced Performance 时：

温度组别	环境温度
T6	$-60^{\circ}\text{C} \leq T_a \leq +40^{\circ}\text{C}$
T5	$-60^{\circ}\text{C} \leq T_a \leq +85^{\circ}\text{C}$

2. 最高工作电压：45Vdc
3. 现场安装时，电缆引入口须选用经国家指定的防爆检验机构检验认可、具有 Ex e IIC Gb 防爆等级的电缆引入装置或堵封件，冗余电缆引入口须用堵封件有效密封。电缆引入装置或堵封件的安装使用必须遵守其使用说明书的要求并保证外壳防护等级达到 IP54（符合 GB/T4208-2017 标准要求）以上。
4. 用户不得自行更换该产品的零部件，应会同产品制造商共同解决运行中出现的故障，以杜绝损坏现象的发生。
5. 产品的安装、使用和维护应同时遵守产品使用说明书、GB3836.13-2013“爆炸性环境 第 13 部分：设备的修理、检修、修复和改造”、GB/T3836.15-2017“爆炸性环境 第 15 部分：电气装置的设计、选型和安装”、GB/T3836.16-2017“爆炸性环境 第 16 部分：电气装置的检查和维护”和 GB50257-2014“电气装置安装工程 爆炸和火灾危险环境电力装置施工及验收规范”的有关规定。

## 7.10 EAC - Belarus, Kazakhstan, Russia

### 7.10.1 EM Technical Regulation Customs Union TR CU 012/2011 (EAC) Flameproof

**Standards:** GOST 31610.0-2014, GOST IEC 60079-1-2011

**Markings:** 1Ex d IIC T6...T1 Gb X, T6 ( $-55^{\circ}\text{C} \leq T_a \leq +40^{\circ}\text{C}$ ), T5...T1 ( $-55^{\circ}\text{C} \leq T_a \leq +60^{\circ}\text{C}$ );

See [Table 7-1](#) for process temperatures.

#### Special Conditions for Safe Use (X):

1. See certificate TR CU 012/2011 for ambient temperature range.
2. Guard the LCD display cover against impact energies greater than 4 joules.
3. Flameproof joints are not intended for repair.
4. Non-standard paint options may cause risk from electrostatic discharge. Avoid installations that cause electrostatic build-up on painted surfaces, and only clean the painted surfaces with a damp cloth. If paint is ordered through a special code, contact the manufacturer for more information.

### 7.10.2 IM Technical Regulation Customs Union TR CU 012/2011 (EAC) Intrinsic Safety

**Standards:** GOST 31610.0-2014, GOST 31610.11-2014

**Markings:** [HART]: 0Ex ia IIC T6...T4 Ga X; [Fieldbus, FISCO, PROFIBUS PA]: 0Ex ia IIC T4 Ga X

See [Table 7-5](#) for Entity Parameters and Temperature Classifications.

#### Special Conditions for Safe Use (X):

1. The equipment must be installed in an enclosure which affords it a degree of protection of at least IP20 in accordance with the requirements of GOST 14254-96. Non-metallic enclosures must have a surface resistance of less than  $1 \Omega$ ; light alloy or zirconium enclosures must be protected from impact and friction when installed in a Zone 0 environment.
2. When fitted with the Transient Protector Assembly, the equipment is not capable of withstanding the 500 V test as defined in GOST 31610.11-2014. This must be taken into account during installation.
3. See certificate TR CU 012/2011 for ambient temperature range.

### 7.10.3 KM Technical Regulation Customs Union TR CU 012/2011 (EAC) Flameproof, Intrinsic Safety, and Dust-Ignitionproof

**Standards:** GOST 31610.0-2014, GOST IEC 60079-1-2011, GOST 31610.11-2014, GOST R IEC 60079-31-2010

**Markings:** Ex tb IIIC T130 °C Db X (-55 °C ≤ T<sub>a</sub> ≤ +70 °C); IP66

See [Table 7-1](#) for process temperatures.

See EM for Flameproof Markings and see IM for Intrinsic Safety Markings.

#### Special Conditions for Safe Use (X):

1. The non-metallic label may store an electrostatic charge and become a source of ignition in Group III environments. Label must be cleaned by the damp cloth with antistatic to avoid store an electrostatic discharge.
2. Guard the LCD display cover against impact energies greater than 4 joules.

See EM for Flameproof Specific Conditions of Use and see IM for Intrinsic Safety Specific Conditions of Use.

## 7.11 Japan

### 7.11.1 E4 Japan Flameproof

**Certificate:** CML 17JPN1316X

**Markings:** Ex d IIC T6...T1 Gb; T6 (-50 °C < T<sub>a</sub> < +40 °C); T5...T1 (-50 °C ≤ T<sub>a</sub> ≤ 60 °C)

#### Special Conditions for Safe Use:

1. Flameproof joints are not intended for repair.
2. Models with LCD display cover shall have the display cover protected from impact energies greater than 4 Joules.
3. For Models 65 and 185, the user shall ensure the external surface temperature of the equipment and the neck of the DIN Style probe does not exceed 130 °C.
4. Non-standard paint options may cause risk from electrostatic discharge.
5. The wiring used shall be suitable for temperatures over 80 °C.

### 7.11.2 I4 Japan Intrinsic Safety

**Certificate:** CML 18JPN2118X

**Standards:** JNIOOSH-TR-46-1, JNIOOSH-TR-46-6

**Markings:** [Fieldbus] Ex ia IIC T4 Ga (-60 °C ≤ T<sub>a</sub> ≤ +60 °C);

#### Special Conditions for Safe Use (X):

1. The apparatus must be installed in an enclosure which affords it a degree of protection of at least IP20.
2. Non-metallic enclosures must have a surface resistance of less than 1 G Ω; light alloy or zirconium enclosures must be protected from impact and friction when installed in a zone 0 environment.

## 7.12 Korea

### 7.12.1 EP Korea Flameproof and Dust-Ignitionproof

**Certificate:** 13-KB4BO-0559X

**Markings:** Ex d IIC T6... T1; Ex tb IIIC T130 °C



**Special Condition for Safe Use (X):**

See certificate for special conditions for safe use.

## 7.12.2 IP Korea Intrinsic Safety

**Certificate:** 13-KB4BO-0531X

**Markings:** Ex ia IIC T6...T4

**Special Conditions for Safe Use (X):**

See certificate for special conditions for safe use.

## 7.13 Combinations

**K1** Combination of E1, I1, N1, and ND

**K2** Combination of E2 and I2

**K5** Combination of E5 and I5

**K7** Combination of E7, I7, N7, and NK

**KA** Combination of K6, E1, and I1

**KB** Combination of K5 and K6

**KC** Combination of I5 and I6

**KD** Combination of E5, I5, K6, E1, and I1

**KP** Combination of EP and IP

## 7.14 Additional certifications

## 7.14.1 SBS American Bureau of Shipping (ABS) Type Approval

**Certificate:** 16-HS1553094-PDA

## 7.14.2 SBV Bureau Veritas (BV) Type Approval

**Certificate:** 26325 BV

**Requirements:** Bureau Veritas Rules for the Classification of Steel Ships

**Application:** Class notations: AUT-UMS, AUT-CCS, AUT-PORT and AUT-IMS

## 7.14.3 SDN Det Norske Veritas (DNV) Type Approval

**Certificate:** TAA00000K8

**Application:** Location Classes: Temperature: D; Humidity: B; Vibration: A; EMC: B; Enclosure B/IP66: A, C/IP66: SST

#### 7.14.4 SLL Lloyds Register (LR) Type Approval

**Certificate:** 11/60002

**Application:** For use in environmental categories ENV1, ENV2, ENV3, and ENV5.

### 7.15 Specification tables

**Table 7-1: Process Temperature Limits**

Sensor only (no transmitter installed)	Process temperature [°C]						
	Gas						Dust
	T6	T5	T4	T3	T2	T1	T130 °C
Any extension length	85 °C (185 °F)	100 °C (212 °F)	135 °C (275 °F)	200 °C (392 °F)	300 °C (572 °F)	450 °C (842 °F)	130 °C (266 °F)

**Table 7-2: Process Temperature Limits without LCD Display Cover**

Transmitter	Process temperature [°C]						
	Gas						Dust
	T6	T5	T4	T3	T2	T1	T130 °C
No extension	131 °F (55 °C)	158 °F (70 °C)	212 °F (100 °C)	338 °F (170 °C)	536 °F (280 °C)	824 °F (440 °C)	212 °F (100 °C)
3-in. extension	131 °F (55 °C)	158 °F (70 °C)	230 °F (110 °C)	374 °F (190 °C)	572 °F (300 °C)	842 °F (450 °C)	230 °F (110 °C)
6-in. extension	140 °F (60 °C)	158 °F (70 °C)	248 °F (120 °C)	392 °F (200 °C)	572 °F (300 °C)	842 °F (450 °C)	230 °F (110 °C)
9-in. extension	149 °F (65 °C)	167 °F (75 °C)	266 °F (130 °C)	392 °F (200 °C)	572 °F (300 °C)	842 °F (450 °C)	248 °F (120 °C)

Adhering to the process temperature limitation of [Table 7-3](#) will ensure that the service temperature limitations of the LCD cover are not exceeded. Process temperatures may exceed the limits defined in [Table 7-3](#) if the Temperature of the LCD cover is verified to not exceed the service temperatures in [Table 7-4](#) and the process temperatures do not exceed the values specified in [Table 7-2](#).

**Table 7-3: Process Temperature Limits with LCD Display Cover**

Transmitter with LCD display cover	Process temperature [°C]			
	Gas			Dust
	T6	T5	T4...T1	T130 °C
No extension	131 °F (55 °C)	158 °F (70 °C)	203 °F (95 °C)	203 °F (95 °C)
3-in. extension	131 °F (55 °C)	158 °F (70 °C)	212 °F (100 °C)	212 °F (100 °C)
6-in. extension	140 °F (60 °C)	158 °F (70 °C)	212 °F (100 °C)	212 °F (100 °C)
9-in. extension	149 °F (65 °C)	167 °F (75 °C)	230 °F (110 °C)	110 °C (230 °F)



**Table 7-4: Service Temperature Limits**



Transmitter with LCD display cover	Service temperature [°C]			
	Gas			Dust
	T6	T5	T4...T1	T130 °C
No extension	149 °F (65 °C)	167 °F (75 °C)	203 °F (95 °C)	203 °F (95 °C)

**Table 7-5: Entity Parameters**

	Fieldbus/PROFIBUS [FISCO]	HART	HART (Enhanced)
U <sub>i</sub> (V)	30 [17.5]	30	30
I <sub>i</sub> (mA)	300 [380]	200	150 for T <sub>a</sub> ≤ 80 °C 170 for T <sub>a</sub> ≤ 70 °C 190 for T <sub>a</sub> ≤ 60 °C
P <sub>i</sub> (W)	1.3 at T4 (-50 °C ≤ T <sub>a</sub> ≤ +60 °C) [5.32 at T4 (-50 °C ≤ T <sub>a</sub> ≤ +60 °C)]	.67 at T6 (-60 °C ≤ T <sub>a</sub> ≤ +40 °C) .67 at T5 (-60 °C ≤ T <sub>a</sub> ≤ +50 °C) 1.0 at T5 (-60 °C ≤ T <sub>a</sub> ≤ +40 °C) 1.0 at T4 (-60 °C ≤ T <sub>a</sub> ≤ +80 °C)	.67 at T6 (-60 °C ≤ T <sub>a</sub> ≤ +40 °C) .67 at T5 (-60 °C ≤ T <sub>a</sub> ≤ +50 °C) .80 at T5 (-60 °C ≤ T <sub>a</sub> ≤ +40 °C) .80 at T4 (-60 °C ≤ T <sub>a</sub> ≤ +80 °C)
C <sub>i</sub> (nF)	2.1	10	3.3
L <sub>i</sub> (mH)	0	0	0

# 8 Declaration of Conformity

	<b>EU Declaration of Conformity</b> No: RMD 1016 Rev. Y	
<p>We,</p>		
<p><b>Rosemount, Inc.</b>  <b>8200 Market Boulevard</b>  <b>Chanhasen, MN 55317-9685</b>  <b>USA</b></p>		
<p>declare under our sole responsibility that the product,</p>		
<p><b>Rosemount™ 644 Temperature Transmitter</b></p>		
<p>manufactured by,</p>		
<p><b>Rosemount, Inc.</b>  <b>8200 Market Boulevard</b>  <b>Chanhasen, MN 55317-9685</b>  <b>USA</b></p>		
<p>to which this declaration relates, is in conformity with the provisions of the European Union Directives, including the latest amendments, as shown in the attached schedule.</p>		
<p>Assumption of conformity is based on the application of the harmonized standards and, when applicable or required, a European Union notified body certification, as shown in the attached schedule.</p>		
	<p>Vice President of Global Quality</p>	
<p>(signature)</p>	<p>(function)</p>	
<p>Chris LaPoint</p>	<p>1-April-2019</p>	
<p>(name)</p>	<p>(date of issue)</p>	
<p>Page 1 of 4</p>		

	<b>EU Declaration of Conformity</b> No: RMD 1016 Rev. Y	
<b>EMC Directive (2014/30/EU)</b> Harmonized Standards: EN 61326-1:2013, EN 61326-2-3: 2013		
<b>ATEX Directive (2014/34/EU)</b>		
<b>Rosemount 644 Enhanced Head/Field Mount Temperature Transmitters (Analog/HART Output)</b>		
<b>Baseefa12ATEX0101X – Intrinsic Safety Certificate</b> Equipment Group II, Category 1 G Ex ia IIC T6...T4 Ga Harmonized Standards: EN IEC 60079-0:2018; EN 60079-11:2012		
<b>Baseefa12ATEX0102U – Type n Certificate; no enclosure option</b> Equipment Group II, Category 3 G Ex nA IIC T6...T5 Gc Harmonized Standards: EN IEC 60079-0:2018; EN 60079-15:2010		
<b>Rosemount 644 Head Mount Temperature Transmitter (Fieldbus Output)</b>		
<b>Baseefa03ATEX0499X – Intrinsic Safety Certificate</b> Equipment Group II, Category 1 G Ex ia IIC T4 Ga Harmonized Standards: EN IEC 60079-0:2018; EN 60079-11:2012		
<b>Baseefa13ATEX0093X – Type n Certificate; no enclosure option</b> Equipment Group II, Category 3 G Ex nA IIC T5 Gc Harmonized Standards: EN IEC 60079-0:2018; EN 60079-15:2010		
Page 2 of 4		



# EU Declaration of Conformity



No: RMD 1016 Rev. Y

**Rosemount 644 Head/Field Mount Temperature Transmitter  
(All output protocols)**

**FM12ATEX0065X – Flameproof Certificate**

Equipment Group II, Category 2 G  
Ex db IIC T6...T1 Gb

Harmonized Standards:

EN 60079-0:2012+A11:2013, EN 60079-1:2014

**FM12ATEX0065X – Dust Certificate**

Equipment Group II, Category 2 D  
Ex tb IIIC T130°C Db

Harmonized Standards:

EN 60079-0:2012+A11:2013, EN 60079-31:2014

**BAS00ATEX3145 – Type n Certificate**

Equipment Group II, Category 3 G  
Ex nA IIC T5 Gc

Harmonized Standards:

EN 60079-0:2012+A11:2013; EN 60079-15:2010

**Rosemount 644R Rail Mount Temperature Transmitters  
(HART Output)**

**BAS00ATEX1033X – Intrinsic Safety Certificate**

Equipment Group II, Category 1 G  
Ex ia IIC T6...T4 Ga

Harmonized Standards:

EN IEC 60079-0:2018; EN 60079-11:2012

**Baseefa13ATEX0093X – Type n Certificate**

Equipment Group II, Category 3 G  
Ex nA IIC T5 Gc



Harmonized Standards:

EN IEC 60079-0:2018; EN 60079-15:2010

**RoHS Directive (2011/65/EU)**

**644 HART Head Mount**

Harmonized Standard: EN 50581:2012

 **EU Declaration of Conformity**   
**No: RMD 1016 Rev. Y**

**ATEX Notified Bodies**

**FM Approvals Europe Limited** [Notified Body Number: 2809]  
One Georges Quay Plaza  
Dublin, Ireland. D02 E440

**SGS FIMCO OY** [Notified Body Number: 0598]  
P.O. Box 30 (Särkiniementie 3)  
00211 HELSINKI  
Finland

**ATEX Notified Body for Quality Assurance**

**SGS FIMCO OY** [Notified Body Number: 0598]  
P.O. Box 30 (Särkiniementie 3)  
00211 HELSINKI  
Finland

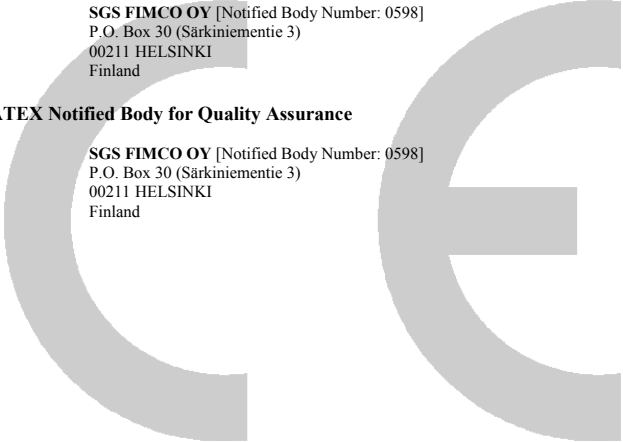

Page 4 of 4

## 9 China RoHS

有害物质成分表  
00079-2000, Rev AB

罗斯蒙特产品型号 644  
7/1/2016

含有 China RoHS 管控物质超过最大浓度限值的部件型号列表 644  
List of 644 Parts with China RoHS Concentration above MCVs

部件名称 Part Name	有害物质 / Hazardous Substances					
	铅 Lead (Pb)	汞 Mercury (Hg)	镉 Cadmium (Cd)	六价铬 Hexavalent Chromium (Cr +6)	多溴联苯 Polybrominated biphenyls (PBB)	多溴联苯醚 Polybrominated diphenyl ethers (PBDE)
电子组件 Electronics Assembly	X	O	O	O	O	O
壳体组件 Housing Assembly	O	O	O	X	O	O
传感器组件 Sensor Assembly	X	O	O	O	O	O

本表格系依据 SJ/T11364 的规定而制作。

This table is proposed in accordance with the provision of SJ/T11364.

O: 意为该部件的所有均质材料中该有害物质的含量均低于 GB/T 26572 所规定的限量要求。

O: Indicate that said hazardous substance in all of the homogeneous materials for this part is below the limit requirement of GB/T 26572.

X: 意为在该部件所使用的的所有均质材料里，至少有一类均质材料中该有害物质的含量高于 GB/T 26572 所规定的限量要求。

X: Indicate that said hazardous substance contained in at least one of the homogeneous materials used for this part is above the limit requirement of GB/T 26572.

部件名称 Part Name	组装备件说明 Spare Parts Descriptions for Assemblies
电子组件 Electronics Assembly	端子块组件 Terminal Block Assemblies 液晶显示屏或本地操作界面 LCD or LOI Display
壳体组件 Housing Assembly	电子外壳 Electrical Housing











### Global Headquarters

Emerson Automation Solutions  
6021 Innovation Blvd.  
Shakopee, MN 55379, USA

- +1 800 999 9307 or +1 952 906 8888
- +1 952 204 8889
- RFQ.RMD-RCC@Emerson.com

### Latin America Regional Office

Emerson Automation Solutions  
1300 Concord Terrace, Suite 400  
Sunrise, FL 33323, USA

- +1 954 846 5030
- +1 954 846 5121
- RFQ.RMD-RCC@Emerson.com

### Asia Pacific Regional Office

Emerson Automation Solutions  
1 Pandan Crescent  
Singapore 128461

- +65 6777 8211
- +65 6777 0947
- Enquiries@AP.Emerson.com

 [Linkedin.com/company/Emerson-Automation-Solutions](https://www.linkedin.com/company/Emerson-Automation-Solutions)

 [Twitter.com/Rosemount\\_News](https://twitter.com/Rosemount_News)

 [Facebook.com/Rosemount](https://www.facebook.com/Rosemount)

 [Youtube.com/user/RosemountMeasurement](https://www.youtube.com/user/RosemountMeasurement)

### North America Regional Office

Emerson Automation Solutions  
8200 Market Blvd.  
Chanhassen, MN 55317, USA

- +1 800 999 9307 or +1 952 906 8888
- +1 952 204 8889
- RMT-NA.RCCRFQ@Emerson.com

### Europe Regional Office

Emerson Automation Solutions Europe  
GmbH  
Neuhofstrasse 19a P.O. Box 1046  
CH 6340 Baar  
Switzerland

- +41 (0) 41 768 6111
- +41 (0) 41 768 6300
- RFQ.RMD-RCC@Emerson.com

### Middle East and Africa Regional Office

Emerson Automation Solutions  
Emerson FZE P.O. Box 17033  
Jebel Ali Free Zone - South 2  
Dubai, United Arab Emirates

- +971 4 8118100
- +971 4 8865465
- RFQ.RMTMEA@Emerson.com

©2020 Emerson. All rights reserved.

Emerson Terms and Conditions of Sale are available upon request. The Emerson logo is a trademark and service mark of Emerson Electric Co. Rosemount is a mark of one of the Emerson family of companies. All other marks are the property of their respective owners.