









# Rosemount™ 8750W IECEx and ATEX Approval Document



## Rosemount 8750W Magnetic Flowmeter Platform

Order Code	8750W Magnetic Flowmeter Platform Rating	Region	Agency	Certification Number
-	Ordinary Locations*	USA, Canada, EU, CU**	CSA, EAC	70081467X(CSA)
Z1	ATEX Non-Sparking or Increased Safety and Dust for Non-Flammable Fluids	EU	DEKRA	15ATEX0003 X
ND	ATEX Dust	EU	DEKRA	15ATEX0003 X
Z2	InMetro Non-Sparking and Dust for Non-Flammable Fluids	Brazil	DNV GL - INMETRO	DNV 18.0082 X
Z3	NEPSI Non-Sparking and Dust for Non-Flammable Fluids	China	NEPSI	GYJ15.1228X
Z5	DIP (Dust-Ignitionproof) Class II and III, Div 1. Non-Incendive, Class I Div 2 for Non-Flammable Fluids	USA	CSA	70081467X(CSA)
Z6	DIP (Dust-Ignitionproof) Class II and III, Div 1. Non-Incendive, Class I Div 2 for Non-Flammable Fluids	USA & Canada	CSA	70081467-X
Z7	IECEX Non-Sparking or Increased Safety and Dust for Non-Flammable Fluids	Global	DEKRA	IECEX DEK 15.0001X
NF	IECEX Dust	Global	DEKRA	IECEX DEK 15.0001X
Z9	KTL Non-Sparking and Dust for Non-Flammable Fluids	Korea	KTL	***
*Complies with only the local country Product safety, Electromagnetic, Pressure and other applicable regulations. Cannot be used in a classified or zoned hazardous location environment.				
** Customs Union (Russia, Belarus and Kazakhstan)				
*** Future				

### Approval Markings and Logos

Symbol	Marking or Symbol Name	Region	Meaning of Marking or Symbol
	CE	European Union	Compliance with all applicable European Union Directives.
	ATEX	European Union	Compliance with Equipment and Protective systems intended for use in Potentially Explosive Atmospheres directive (ATEX) (94/9/EC)
	C-tick	Australia	Compliance with Australian applicable electromagnetic compatibility standards
	CSA	US = United States C = Canada	Indicates that the product was tested and has met the applicable certification requirements for the noted countries.
	Eurasian Conformity (EAC)	Eurasian Customs Union (Russia, Belarus and Kazakhstan)	Compliance with all of the applicable technical regulations of the EAC Customs Union
	DNV GL - INMETRO	Brazil	Compliance with all of the applicable technical regulations of Brazil.
	NEPSI	China	Compliance with all of the applicable technical regulations of China.
	KTL	Korea	Compliance with all of the applicable technical regulations of Korea.

Ordinary Location labels will be marked with CE, C-tick, CSA and EAC logos.

### European Directive Information

The most recent revision of the EU Declaration of Conformity can be found at [www.emerson.com](http://www.emerson.com).

## Certifications

### Canadian Standards Association (CSA)

#### Ordinary Location Certification

The transmitter and flowtube have been examined and tested to determine that the design meets basic electrical, mechanical, and fire protection requirements by CSA, a nationally recognized testing laboratory (NRTL) as accredited by the Federal Occupational Safety and Health Administration (OSHA).

#### CLASS 2258 02 - PROCESS CONTROL EQUIPMENT - For Hazardous Locations – To Canadian Requirements.

<b>Z6, Z5</b>	<b>Class I, Division 2, Groups A, B, C and D; T4 (Non-Incendive)</b>
<b>ZC</b>	<b>Ex nA [ic] IIC T4 Gc (Transmitter – DC Powered Only)</b>
<b>ZC</b>	<b>Ex ec [ic] IIC T4 Gc (Transmitter – DC Powered Only)</b>
<b>ZC</b>	<b>Ex nA ic [ic] IIC T4 Gc (8750WDMW Transmitter – DC Powered Only)</b>
<b>ZC</b>	<b>Ex ec ic [ic] IIC T4 Gc (8750WDMWTransmitter – DC Powered Only)</b>
<b>ZC</b>	<b>Ex nA ic IIC T5...T4 Gc (Flow Tube)</b>
<b>ZC</b>	<b>Ex ec ic IIC T5...T4 Gc (Flow Tube)</b>
<b>Z6, Z5</b>	<b>Class II, Division 1, Groups E, F and G, T5; Class III (Dust Ignition Proof)</b>
<b>ZC</b>	<b>Ex tc IIIC T80 °C...T130 °C Dc (Transmitter and Flow Tube)</b>
<b>ZC</b>	<b>Ex tc IIIC T80 °C Dc (8750WDMW Transmitter)</b>

#### CLASS 2258 82 - PROCESS CONTROL EQUIPMENT - For Hazardous Locations –To US Requirements

<b>Z6, Z5</b>	<b>Class I, Division 2, Groups A, B, C and D; T4 (Non-Incendive)</b>
<b>ZC</b>	<b>Class I, Zone 2, AEx nA [ic] IIC T4 Gc (Transmitter – DC Powered Only)</b>
<b>ZC</b>	<b>Class I, Zone 2, AEx ec [ic] IIC T4 Gc (Transmitter – DC Powered Only)</b>
<b>ZC</b>	<b>Class I, Zone 2, AEx nA ic [ic] IIC T4 Gc (8750WDMW Transmitter – DC Powered Only)</b>
<b>ZC</b>	<b>Class I, Zone 2, AEx ec ic [ic] IIC T4 Gc (8750WDMWTransmitter – DC Powered Only)</b>
<b>ZC</b>	<b>Class I, Zone 2, AEx nA ic IIC T5...T4 Gc (Flow Tube)</b>
<b>ZC</b>	<b>Class I, Zone 2, AEx ec ic IIC T5...T4 Gc (Flow Tube)</b>
<b>Z6, Z5</b>	<b>Class II, Division 1, Groups E, F and G, T5; Class III (Dust Ignition Proof)</b>
<b>ZC</b>	<b>Class II, Zone 22, AEx tc IIIC T80°C... 130°C Dc (Transmitter and Flow Tube)</b>
<b>ZC</b>	<b>Ex tc IIIC T80 °C Dc (8750WDMW Transmitter)</b>

#### 8750W Magnetic Flowtube and Transmitter

<b>Z6, Z5</b>	All Flowtubes and Integral or Remote Mount Transmitters (Transmitter mount codes T or R) Non-Incendive for Class I, Division 2, Groups ABCD: T4 Dust-Ignition Proof for Class II/III, Division 1, Groups EFG: T5 -29°C ≤ Ta ≤ 60°C Enclosure Type 4X, IP66/68 (IP68 flowtube only with Remote mount transmitter) Install per drawing 8750W-1051
---------------	--

#### 8750W Magnetic Flowtube and Transmitter

<b>Z6, Z5</b>	All Flowtubes and Wall Mount Transmitter (Transmitter mount code W) Non-Incendive for Class I, Division 2, Groups ABCD: T4 Dust-Ignition Proof for Class II/III, Division 1, Groups EFG: T4 -29°C ≤ Ta ≤ 40°C Enclosure Type 4X, IP66/68/69K (IP68 flowtube only; IP69K Transmitter mount code WDMW) Install per drawing 8750W-1051
---------------	--

**Special Conditions of Safe Use for Class/Division**

1. Flow tube to be used only in a non-flammable process.

**Special Conditions for Safe Use (X) for Class Zone:**

1. When "Special Paint Systems" are applied, instructions for safe use regarding potential electrostatic charging hazard have to be followed.
2. Conduit entries must be installed to maintain the enclosure ingress rating of IP66 (Transmitter and Flow Tube), IP68 (Flow Tube) or IP69K (Flow Tube or 8750W...W transmitter) as applicable.
3. Terminals for the output signals of the Magnetic Flow Transmitters, cannot withstand the 500 V isolation test between signal and ground, due to integral transient protection. This must be taken into account upon installation.
4. When utilizing the keypad of Magnetic Flow Transmitter Model 8750W...W, instructions for safe use regarding potential electrostatic charging hazard have to be followed.

# Rosemount 8750W Magnetic Flowmeter Platform IECEX & ATEX Approval Document

14 September 2018,  
8750W-AP02, Rev AC

1. Equipment Markings – See section VI in the tables on the following pages
  - a. Type Examination Certificate (ATEX): DEKRA 15ATEX0003 X
  - b. Certificate of Conformity (IECEX): IECEX DEK 15.0001X
2. Required Documentation:
  - a. 8750W-2052 Installation Drawing Model 8750W ATEX/IECEX Hazardous (Ex) Locations
3. Referenced Documentation:
  - a. 00825-0X00-4444.pdf, Transmitter Quick Installation Guide (Where X = Communications Protocol Code)
  - b. 00825-0300-4750.pdf, Sensor Quick Installation Guide
4. The Required and Referenced Documents listed above address the following items:
  - a. Instructions for safety i.e.
    - i. Putting into service
    - ii. Use
    - iii. Assembling and dismantling
    - iv. Maintenance, overhaul and repair
    - v. Installation
    - vi. Adjustment
  - b. Where necessary, training instructions
  - c. Details which allow a decision to be made as to whether the equipment can be used safely in the intended area under the expected operating conditions
  - d. Electrical parameters, maximum surface temperatures and other limit values
    - i. Electrical –
      1. See document 8750W-2052

<b>Rosemount 8750W Flow Transmitter</b>	
<i>Power input</i>	90 - 250VAC, 0.45A, 40VA 12 - 42VDC, 1.2A, 15W
<i>Pulsed circuit</i>	<i>Internally powered (Active): Outputs up to 12VDC, 12.1mA, 73mW</i> <i>Externally powered (Passive): Input up to 28VDC, 100mA, 1W</i>
<i>4-20mA output circuit</i>	<i>Internally Powered (Active): Outputs up to 25mA, 24VDC, 600mW</i> <i>Externally Powered (Passive): Input up to 25mA, 30VDC, 750mW</i>
<i>MODBUS</i>	<i>Internally Powered (Active): Outputs up to 100mA, 3.3VDC, 100mW</i>
<i>Fieldbus</i>	<i>Externally Powered (Passive): 9-32VDC,</i>
<i>Profibus</i>	<i>Externally Powered (Passive): 9-32VDC,</i>
<i>Um</i>	250V
<i>Coil excitation output</i>	500mA, 40V max, 9W max
<b>Rosemount 8750W Flowtube<sup>(1)</sup></b>	
<i>Coil excitation input</i>	500mA, 40V max, 20W max
<i>Electrode circuit</i>	5V, 200uA, 1mW

(1) Provided by the transmitter

Special Conditions for Safe Use (X):

- i. Terminals for the output signals of the Magnetic Flow Transmitters, cannot withstand the 500 V isolation test between signal and ground, due to integral transient protection. This must be taken into account upon installation.
  - ii. When utilizing the keypad of Magnetic Flow Transmitter Model 8750W...W, instructions for safe use regarding potential electrostatic charging hazard have to be followed.
  - iii. When "Special Paint Systems" are applied, instructions for safe use regarding potential electrostatic charging hazard have to be followed.
  - iv. Conduit entries must be installed to maintain the enclosure ingress rating of IP66 (Transmitter and Flow Tube), IP68 (Flow Tube) or IP69K (Flow Tube or 8750W...W transmitter) as applicable.
- e. Where necessary, the essential characteristics of tools which may be fitted to the equipment
- i. No proprietary tools required.
- f. List of the standards, including the issue date, with which the equipment is declared to comply:
- i. ATEX - EN 60079-0 : 2012 + A11 : 2013, EN 60079-7: 2015, EN 60079-11 : 2012, EN 60079-15 : 2010, EN 60079-31 : 2014
  - ii. IECEx - IEC 60079-0: 2011, IEC 60079-7: 2015, IEC 60079-11: 2011, IEC 60079-15: 2010, IEC 60079-31: 2013
- g. Supply wire requirements;  
Use 10 - 18 AWG wire rated for the proper temperature of the application. For wire 10 - 14 AWG use lugs or other appropriate connectors. For connections in ambient temperatures above 122°F (50 °C), use a wire rated for 194 °F (90 °C).
- h. Contact address;           Emerson -Rosemount, Micro Motion Inc  
  12001 Technology Drive  
  Eden Prairie, MN 55344, United States of America

# Rosemount 8750W Magnetic Flowmeter Platform IECEx & ATEX Approval Document

14 September 2018,  
8750W-AP02, Rev AC

## Nomenclature Magnetic Flow Meter System Model 8750W and electrical data

8750W    ...    R    1    A    2    ...    F    005    ...    Z1    ...    M4    ...    AX    ...    V1    ...    R50  
 I                    II    III    IV    V                    VI    VII                    VIII                    IX                    X                    XI                    XII

Designation	Explanation	Value	Explanation
I	Model	8750W	Flow Meter System Model 8750W
II	Transmitter Mount	R T W	Remote Mount Integral Mount Wall Mount
III	Transmitter Power Supply	1 2	AC (90 - 250 Vac, 50 / 60 Hz), not for Ex nA or Ex ec DC (12 - 42 Vdc)
IV	Transmitter Outputs	A M F P 0	Non-I.S.: 4 - 20 mA with digital HART Protocol & Scalable Pulse Output Non-I.S.: Modbus RS-485 I.S.: Foundation Fieldbus / FISCO Intrinsically Safe & Intrinsically Safe Scalable Pulse Output I.S.: Profibus & Intrinsically Safe Scalable Pulse Output Spare Flow Tube, no Transmitter
V	Conduit Entries	1 2 4 5	½-14 NPT female CM20, M20 female ½-14 NPT female, 8750W...R / T only CM20, M20 female, 8750W...R / T only
VI	Electrode Type	A, B, E, F 0	Seal of electrodes comply with IEC 61010-1. Spare Transmitter, No Flow Tube
VII	Line Size	005 to 480 000	½" NPS (15 mm) to 48" NPS (1200 mm) Spare Transmitter, no Flow Tube
VIII	Safety Approvals	Z1 ATEX	Transmitter Models 8750W...R and 8750W...T: Ⓢ II 3 G        Ex nA [ic] IIC T4 Gc * Ⓢ II 3 G        Ex ec [ic] IIC T4 Gc * Ⓢ II 3 D        Ex tc IIIC T80 °C...T130 °C Dc ** Transmitter Model 8750W...W: Ⓢ II 3 G        Ex nA ic [ic] IIC T4 Gc * Ⓢ II 3 G        Ex ec ic [ic] IIC T4 Gc * Ⓢ II 3 D        Ex tc IIIC T80 °C Dc ** Flow Tube: Ⓢ II 3 G        Ex nA ic IIC T5...T4 Gc Ⓢ II 3 G        Ex ec ic IIC T5...T4 Gc Ⓢ II 3 D        Ex tc IIIC T80 °C...T130 °C Dc
		Z7 / Z9 IECEx	Transmitter Models 8750W...R and 8750W...T: Ex nA [ic] IIC T4 Gc * Ex ec [ic] IIC T4 Gc * Ex tc IIIC T80 °C...T130 °C Dc ** Transmitter Model 8750W...W: Ex nA ic [ic] IIC T4 Gc * Ex ec ic [ic] IIC T4 Gc * Ex tc IIIC T80 °C Dc ** Flow Tube: Ex nA ic IIC T5...T4 Gc Ex ec ic IIC T5...T4 Gc Ex tc IIIC T80 °C...T130 °C Dc
		ND ATEX	Transmitter Models 8750W...R and 8750W...T + Flow Tube: Ⓢ II 3 D        Ex tc IIIC T80 °C...T130 °C Dc ** Ⓢ II (3) G        [Ex ic Gc] IIC *** Transmitter Model 8750W...W: Ⓢ II 3 D        Ex tc IIIC T80 °C Dc ** Ⓢ II (3) G        [Ex ic Gc] IIC ***
		NF IECEx	Transmitter Models 8750W...R and 8750W...T + Flow Tube: Ex tc IIIC T80 °C...T130 °C Dc ** [Ex ic Gc] IIC *** Transmitter Model 8750W...W: Ex tc IIIC T80 °C Dc ** [Ex ic Gc] IIC ***
			NOTE: * Model 8750W Transmitter DC Power Supply only ** Model 8750W Transmitter AC and DC Power Supply *** Intrinsically Safe Output (see IV) option only



**Nomenclature Magnetic Flow Meter System Model 8750W and electrical data (continued)**

8750W    ...    R    1    A    2    ...    F    005    ...    Z1    ...    M4    ...    AX    ...    V1    ...    R50  
 I                    II    III    IV    V                    VI    VII                    VIII                    IX                    X                    XI                    XII

Designation	Explanation	Value	Explanation
IX	Transmitter Display	-- M4 M5	Without LOI and keypad LOI (+keypad for Transmitter model 8750W...W only) Display
X	Transmitter Discrete Input / Output	AX	Two Discrete Channels (DI/DO 1, DO 2)
XI	Specials Paint	Vx	Special Paint Systems *** NOTE: *** Subject to special conditions for safe use.
XII	Remote Cable	Rxx ****	Standard Temperature Component NOTE: **** Length = XX x 10ft., max 500 ft.



**ROSEMOUNT™**

**EU Declaration of Conformity No: RFD 1098 Rev. L**

We,

**Emerson – Rosemount, Micro Motion Inc.  
12001 Technology Drive  
Eden Prairie, MN 55344  
USA**

declare under our sole responsibility that the product(s),

**Rosemount Model 8750W Magnetic Flowmeters**

to which this declaration relates, is in conformity with the provisions of the European Union Legislation, including the latest amendments, as shown in the attached schedule.

Assumption of conformity is based on the application of harmonized or applicable technical standards and, when applicable or required, a European Union Legislation notified body certification, as shown in the attached schedule.

(signature)

**14 February 2019**

(date of issue)

**Mark Fleigle**

(name - printed)

**Vice President - Technology and Product Development**

(function name - printed)



**ROSEMOUNT™**

**Schedule**  
**EU Declaration of Conformity RFD 1098 Rev. L**

**LVD Directive 2014/35/EU**

**All Models:** EN 61010-1: 2010

---

**EMC Directive 2014/30/EU**

**All Models:** EN 61326-1: 2013

---

**PED Directive 2014/68/EU**

**Model 8750W Magnetic Flowmeter Sensor with Option “PD”, in Line Sizes 1.5” – 24”**

**Equipment without the ‘PD’ option is NOT PED compliant and cannot be used in the EEA without further assessment unless the installation is exempt under Article 1, paragraph 2 of the PED Directive 2014/68/EU.**

QS Certificate of Assessment - 12317-2018-CE-USA-ACCREDIA  
Module H Conformity Assessment  
ASME B31.3: 2016

**Model 8750W in Line Sizes 0.5” – 1.0”**

Sound Engineering Practice  
ASME B31.3: 2016

---



**ROSEMOUNT™**

**Schedule**  
**EU Declaration of Conformity RFD 1098 Rev. L**

**ATEX Directive 2014/34/EU**

**Model 8750W Magnetic Flowmeter Transmitter and Sensors**

**CERTIFICATE: DEKRA 15ATEX0003 X**

**Equipment Marking Summary:**



- II 3 G Ex nA [ic] IIC T4 Gc
- II 3 G Ex ec [ic] IIC T4 Gc
- II 3 G Ex nA ic IIC T5...T4 Gc
- II 3 G Ex ec ic IIC T5...T4 Gc
- II 3 G Ex nA ic [ic] IIC T4 Gc
- II 3 G Ex ec ic [ic] IIC T4 Gc
- II 3 G [Ex ic Gc] IIC
- II 3 D Ex tc IIIC T 80°C Dc
- II 3 D Ex tc IIIC T 80°C...T 130°C Dc

EN 60079-0: 2012 +A11:2013  
EN 60079-15: 2010

EN 60079-7: 2015  
EN 60079-31: 2014

EN 60079-11: 2012

**PED Notified Body**

**DNV GL Business Assurance S.r.l.** [Notified Body Number: 0496]  
Via Energy Park 14  
Vimercate, 20871 Italy



PAGE	TITLE
2	GAS ENVIRONMENT - EPL Gc SENSOR WITH ALLOWED INTEGRAL MOUNT EPL Gc TRANSMITTERS
3	GAS ENVIRONMENT - EPL Gc SENSOR WITH ALLOWED REMOTE MOUNT EPL Gc TRANSMITTERS
4	DUST ENVIRONMENT - EPL Dc SENSOR WITH ALLOWED INTEGRAL MOUNT EPL Dc TRANSMITTERS
5	DUST ENVIRONMENT - EPL Dc SENSOR WITH ALLOWED REMOTE MOUNT EPL Dc TRANSMITTERS
6	GAS AND DUST ENVIRONMENT - EPL Gc AND EPL Dc - SENSOR TEMPERATURE CODE VS. PROCESS TEMPERATURE AND INGRESS PROTECTION RATINGS
7	GAS ENVIRONMENT - EPL Gc COIL AND ELECTRODE CIRCUIT WIRING
8	DUST ENVIRONMENT - EPL Dc COIL AND ELECTRODE CIRCUIT WIRING
9	GAS AND DUST ENVIRONMENT - OUTPUT WIRING
10	GAS ENVIRONMENT - INTRINSICALLY SAFE ENTITY CONCEPTS
11	GAS ENVIRONMENT - FISCO CONCEPT

**⚠** WARNING: EXPLOSION HAZARD - PRODUCT INSTALLATION SHALL COMPLY WITH INFORMATION AS STATED IN THIS DOCUMENT.

- 1.** WIRING METHOD SUITABLE FOR APPROPRIATE ZONE AND PROTECTION TYPE.
- 2.** TRANSMITTER MUST NOT BE CONNECTED TO EQUIPMENT GENERATING MORE THAN 250V.
- 3.** COMPONENTS REQUIRED TO HAVE HAZARDOUS (Ex) LOCATION APPROVAL MUST BE APPROVED FOR THE GAS GROUP APPROPRIATE TO AREA CLASSIFICATION.
- 4.** FOR ALL INSTALLATIONS MAXIMUM TERMINAL TIGHTENING TORQUE IS 10.6 IN LBS.

**5.** THE ELECTRODE CIRCUIT AND WIRING MUST BE INSTALLED AS INTRINSICALLY SAFE WHEN THE FLOWTUBE IS INSTALLED IN A HAZARDOUS (Ex) AREA WITH AN EQUIPMENT PROTECTION LEVEL (EPL) OF Gc.

**6.** NO REVISION TO THIS DRAWING WITHOUT PRIOR AGENCY APPROVAL.

**7.** INSTALLATION SHOULD BE IN ACCORDANCE WITH LOCAL AND NATIONAL ELECTRICAL CODE, EN 60079-14 OR IEC 60079-14, ELECTRICAL INSTALLATIONS DESIGN, SELECTION, AND ERECTION.

**8.** SAFETY APPROVALS OPTIONS Z1, Z7, AND Z9 HAVE EPL Dc DUST RATINGS AND MAY BE INSTALLED IN HAZARDOUS DUST (Ex) ENVIRONMENT AS DESCRIBED IN THIS DOCUMENT.

**9.** THE TRANSMITTER IS NOT CAPABLE OF PASSING THE 500V ISOLATION TEST ON TERMINALS DUE TO INTEGRAL TRANSIENT PROTECTION. THIS MUST BE TAKEN INTO ACCOUNT UPON INSTALLATION.

**10.** THE ROSEMOUNT CABLING KITS, FOR INTRINSICALLY SAFE ELECTRODES, INCLUDE A CERTIFICATE OF CONFORMITY (COC) FROM THE MANUFACTURER FOR CAPACITANCE PER FOOT & INDUCTANCE PER FOOT. THESE PARAMETERS ARE ONLY REQUIRED FOR THE ENTITY CONCEPT METHOD OF INSTALLATION.

**11.** THE INTRINSICALLY SAFE ANALOG AND DIGITAL OUTPUTS MUST USE TWISTED PAIR WITH AN INDIVIDUAL SHIELD FOR THE PAIR. IT IS ALSO RECOMMENDED TO USE SHIELDED TWISTED PAIR FOR THE PULSE OUTPUT.

**12.** SEAL APPROVED FOR USE IN APPROPRIATE ZONE AND GAS GROUP.

**13.** TRANSMITTER OUTPUTS ARE CONSIDERED INTRINSICALLY SAFE WHEN INSTALLED IN ACCORDANCE TO INTRINSICALLY SAFE CONCEPTS AND INSTALLATION REQUIREMENTS WITHIN THIS DOCUMENT.

NOTES:

CONFIDENTIAL AND PROPRIETARY INFORMATION IS CONTAINED HEREIN AND MUST BE HANDLED ACCORDINGLY.	SURFACE FINISH UNLESS OTHERWISE SPECIFIED	125°	3RD ANGLE	SIZE	SCALE	REV
UNLESS OTHERWISE SPECIFIED DIMENSIONS IN INCHES (mm). REMOVE ALL BURRS AND SHARP EDGES.	C	-		C	-	AE
-DEC TOLERANCES- X ± .1 [2.5] .XX ± .02 [0.5] .XXX ± .010 [0.25] FRACTIONS ± 1/32 ANGLES ± 2'	<b>EMERSON</b> ROSEMOUNT					
TITLE <b>INSTALLATION DRAWING 8750W, ATEX &amp; IECEX HAZARDOUS LOCATIONS</b>						
DR. J. LAGE 9/16/15 DRAWING NO. 8750W-2052						
APPD. M. MAYER 9/16/15						
DO NOT SCALE PRINT	CAD MAINTAINED (PROJ)	PRODUCT CODE	DOC TYPE	SHEET 1	OF 11	

# GAS ENVIRONMENT - EPL Gc SENSOR WITH ALLOWED INTEGRAL MOUNT EPL Gc TRANSMITTERS

## Ex nA SENSOR INTEGRAL MOUNT CONFIGURATIONS

MODEL 8750WD INTEGRAL MOUNT CONFIGURATION WITH SAFETY APPROVAL OPTION 'Z1', 'Z7', AND 'Z9'

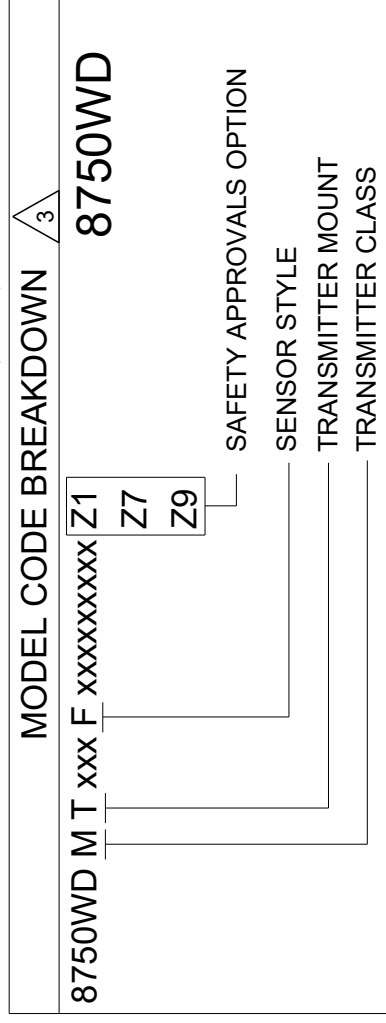

Ex ec ic IIC T5...T4 Gc  
 Ex nA ic IIC T5...T4 Gc  
 EPL Gc, FOR USE IN HAZARDOUS (Ex) AREA - ZONE 2 WITH CARBON STEEL HOUSING (-29°C ≤ Ta ≤ 60°C)  
 SEE TABLE 1 FOR PROCESS TEMPERATURE LIMITS AND ALLOWED MOUNTING CONFIGURATIONS  
 TYPE 'e' OR 'n' WITH INTRINSICALLY SAFE ELECTRODES

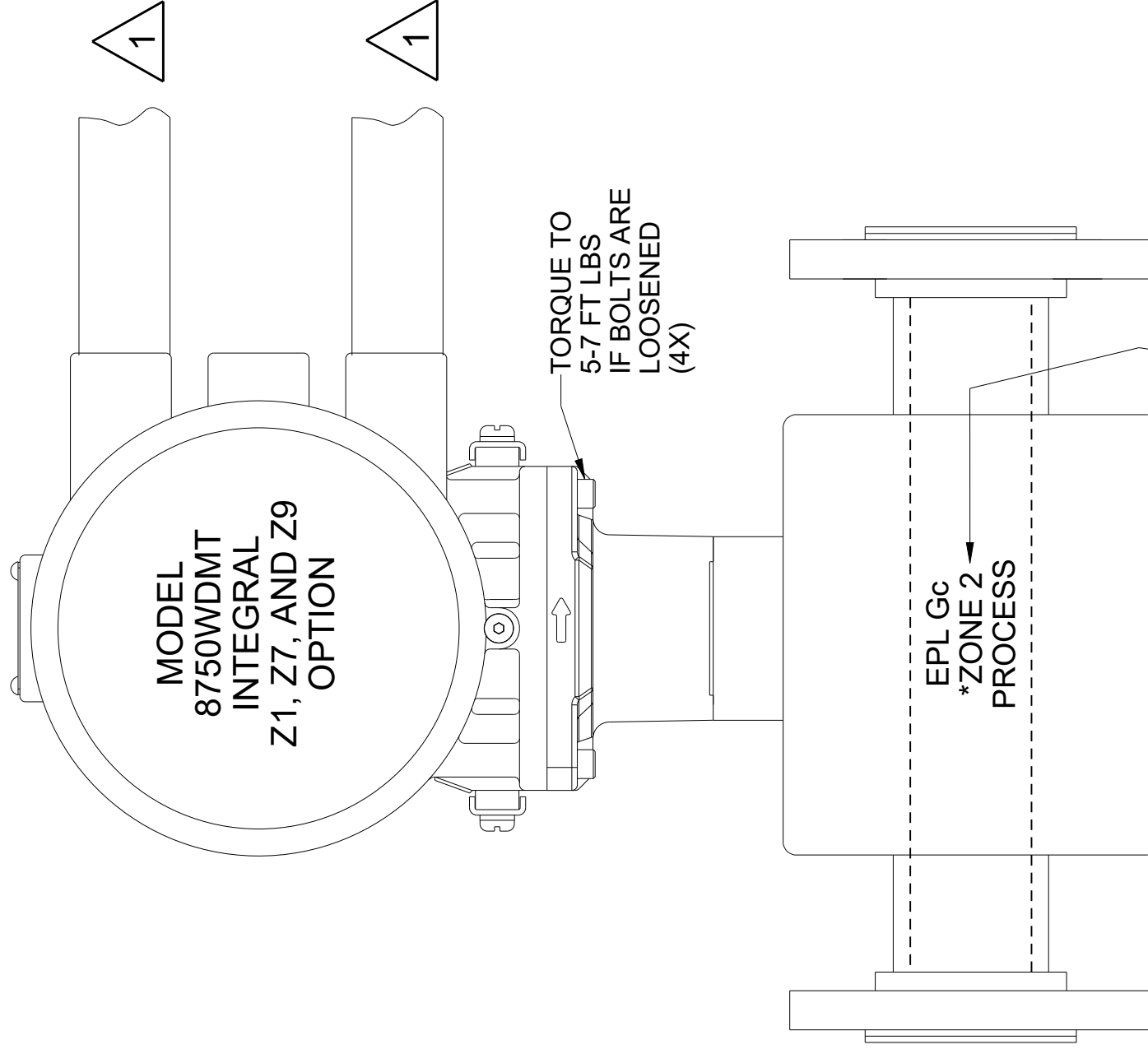

MODEL 8750WDMT INTEGRAL Z1, Z7, AND Z9

⚠ 5 ELECTRODES CONTACT PROCESS

\* TYPICAL APPLICATION: CONSULT LOCAL HAZARDOUS AREA (Ex) ZONING FOR PROCESS FLUID CLASSIFICATION.

## ALLOWED INTEGRAL MOUNT TRANSMITTER CONFIGURATIONS

MODEL 8750WD INTEGRAL MOUNT CONFIGURATION WITH SAFETY APPROVAL OPTION 'Z1', 'Z7', AND 'Z9'

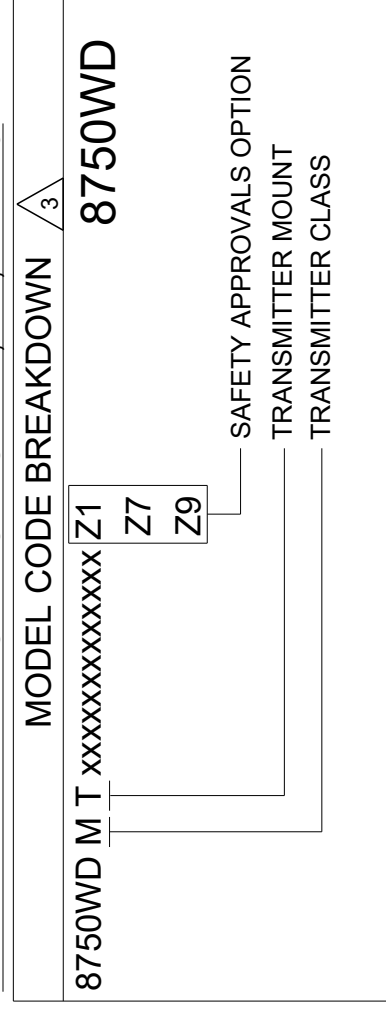

Ex nA [ic] IIC T4 Gc - DC POWER ONLY, IN PROTECTION TYPE 'n'  
 Ex ec [ic] IIC T4 Gc - DC POWER ONLY, IN PROTECTION TYPE 'e'  
 EPL Gc, FOR USE IN HAZARDOUS (Ex) AREA - ZONE 2  
 SEE TABLE 1 FOR PROCESS TEMPERATURE LIMITS AND ALLOWED MOUNTING CONFIGURATIONS

8750W-2052

DRAWING NO.

CONFIDENTIAL AND PROPRIETARY INFORMATION IS CONTAINED HEREIN AND MUST BE HANDLED ACCORDINGLY.	SURFACE FINISH UNLESS OTHERWISE SPECIFIED	125	3RD ANGLE	SIZE	C	SCALE	-	REV	AE
UNLESS OTHERWISE SPECIFIED DIMENSIONS IN INCHES (mm). REMOVE ALL BURRS AND SHARP EDGES.	EMERSON								
-DEC TOLERANCES- X ± .1 [2.5] .XX ± .02 [0.5] .XXX ± .010 [0.25] FRACTIONS ± 1/32 ANGLES ± 2'	ROSEMOUNT								
TITLE INSTALLATION DRAWING 8750W, ATEX & IECEX HAZARDOUS LOCATIONS									
DR. J. LAGE	9/16/15	DRAWING NO. 8750W-2052							
APPD. M. MAYER	9/16/15	PRODUCT CODE							
DO NOT SCALE PRINT   CAD MAINTAINED (PROJ)   SHEET 2 OF 11									

# GAS ENVIRONMENT - EPL Gc SENSOR WITH ALLOWED REMOTE MOUNT EPL Gc TRANSMITTERS

## Ex ec / Ex nA SENSOR REMOTE MOUNT CONFIGURATIONS

MODEL 8750WD REMOTE MOUNT SENSOR CONFIGURATION  
WITH SAFETY APPROVAL OPTION 'Z1', 'Z7', AND 'Z9'

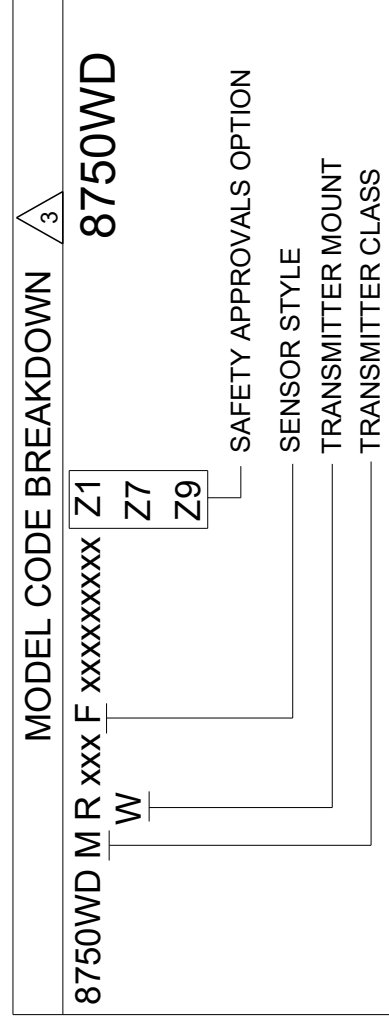

Ex ec ic IIC T5...T4 Gc  
Ex nA ic IIC T5...T4 Gc  
EPL Gc, FOR USE IN HAZARDOUS (Ex) AREA - ZONE 2  
WITH CARBON STEEL HOUSING (-29°C ≤ Ta ≤ 60°C)  
SEE TABLE 1 FOR PROCESS TEMPERATURE LIMITS AND  
ALLOWED MOUNTING CONFIGURATIONS  
TYPE 'e' OR 'n' WITH INTRINSICALLY SAFE ELECTRODES

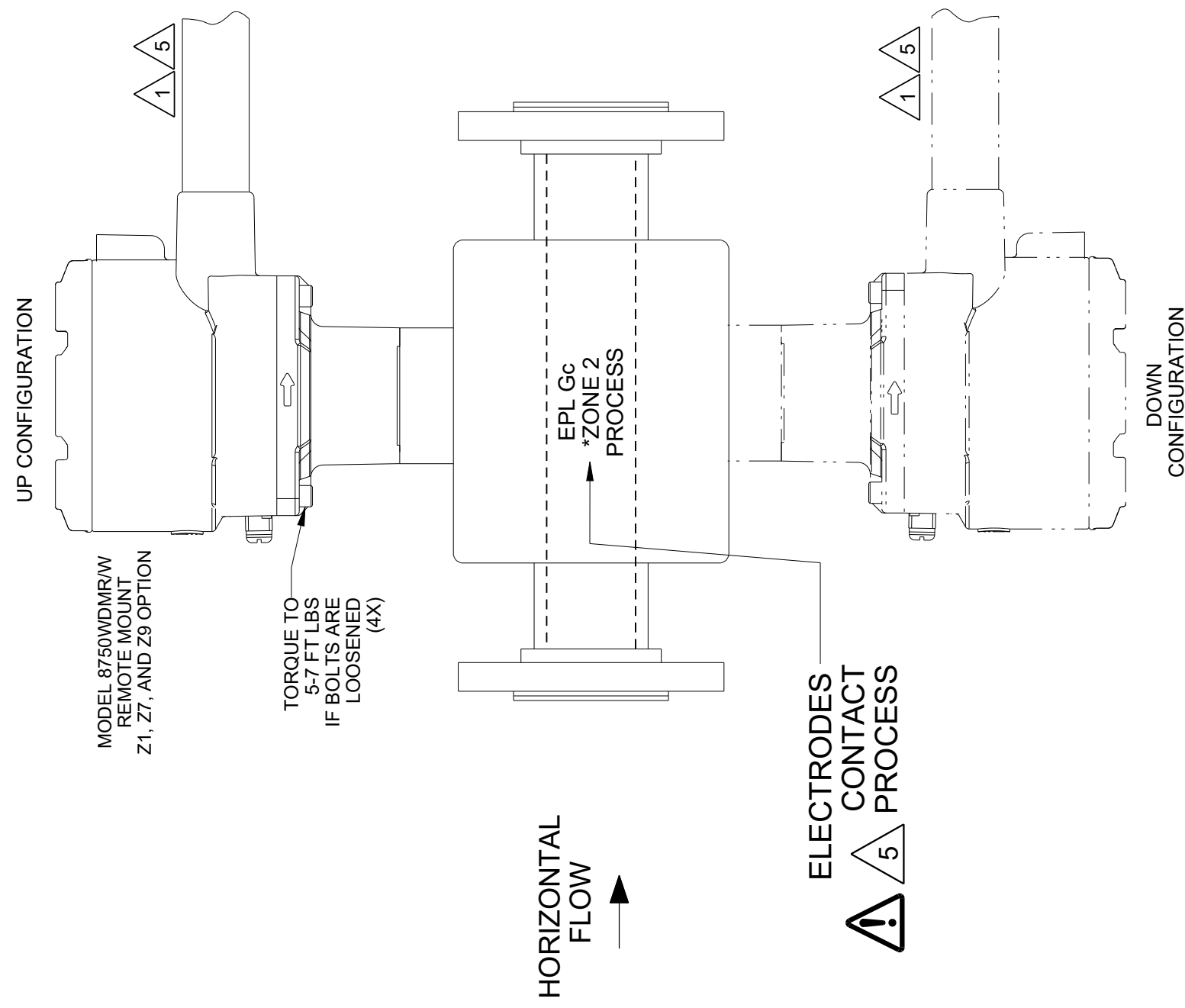

## ALLOWED REMOTE MOUNT TRANSMITTER CONFIGURATIONS

MODEL 8750WD REMOTE FIELD MOUNT CONFIGURATION  
WITH SAFETY APPROVAL OPTION 'Z1', 'Z7', AND 'Z9'

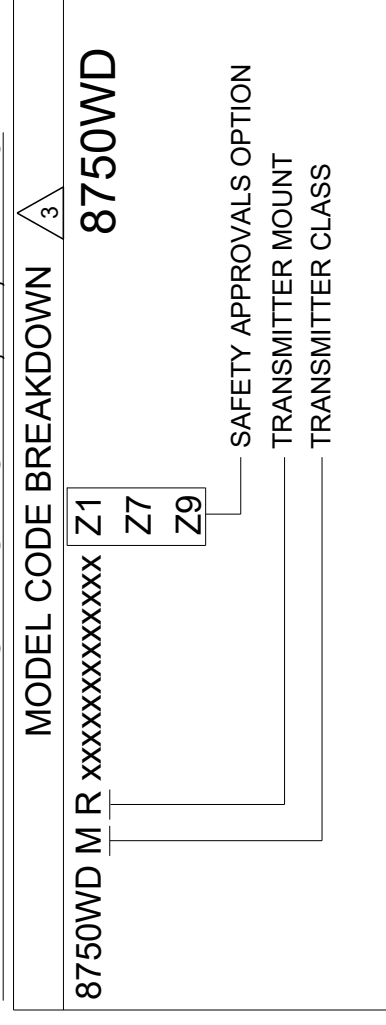

Ex nA ic [ic] IIC T4 Gc - DC POWER ONLY, IN PROTECTION TYPE 'n'  
Ex ec ic [ic] IIC T4 Gc - DC POWER ONLY, IN PROTECTION TYPE 'e'  
EPL Gc, FOR USE IN HAZARDOUS (Ex) AREA - ZONE 2  
TEMPERATURE CLASS: EPL Gc: T4 (-40°C ≤ Ta ≤ 60°C)  
WITH INTRINSICALLY SAFE ELECTRODE CIRCUIT

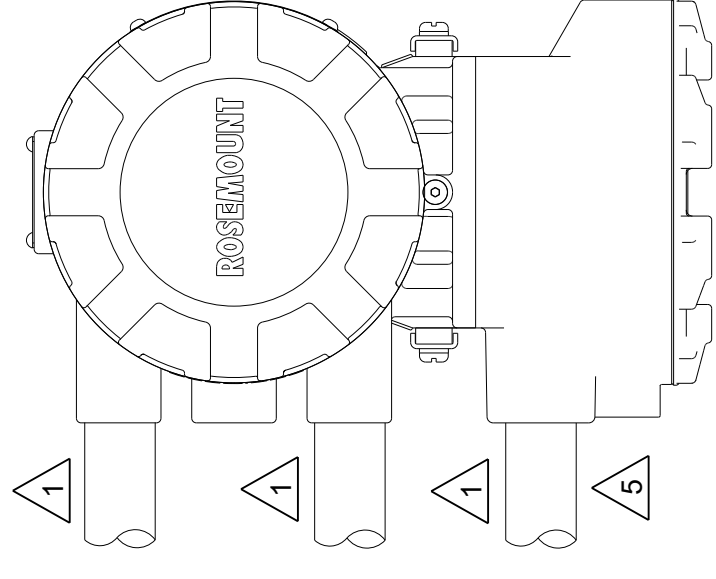

MODEL 8750WDMR  
REMOTE MOUNT  
Z1, Z7, AND Z9 OPTION

MODEL 8750WD REMOTE WALLMOUNT CONFIGURATION  
WITH SAFETY APPROVAL OPTION 'Z1', 'Z7', AND 'Z9'

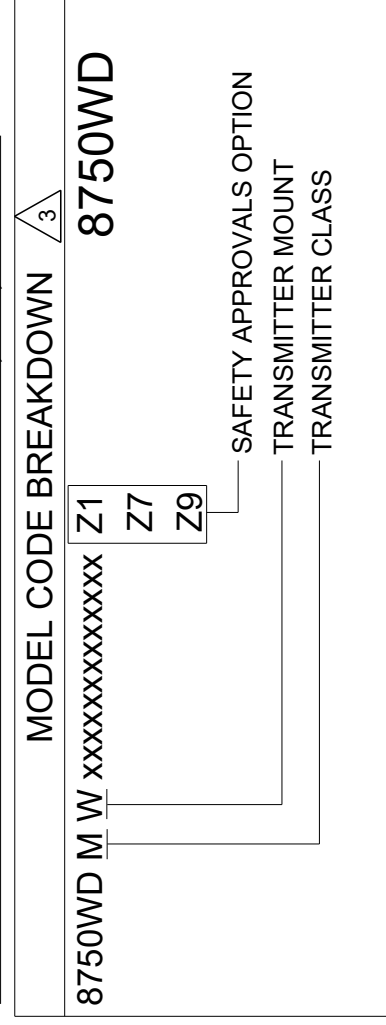

Ex nA ic [ic] IIC T4 Gc - DC POWER ONLY, IN PROTECTION TYPE 'n'  
Ex ec ic [ic] IIC T4 Gc - DC POWER ONLY, IN PROTECTION TYPE 'e'  
EPL Gc, FOR USE IN HAZARDOUS (Ex) AREA - ZONE 2  
TEMPERATURE CLASS: EPL Gc: T4 (-40°C ≤ Ta ≤ 60°C)  
WITH INTRINSICALLY SAFE ELECTRODE CIRCUIT

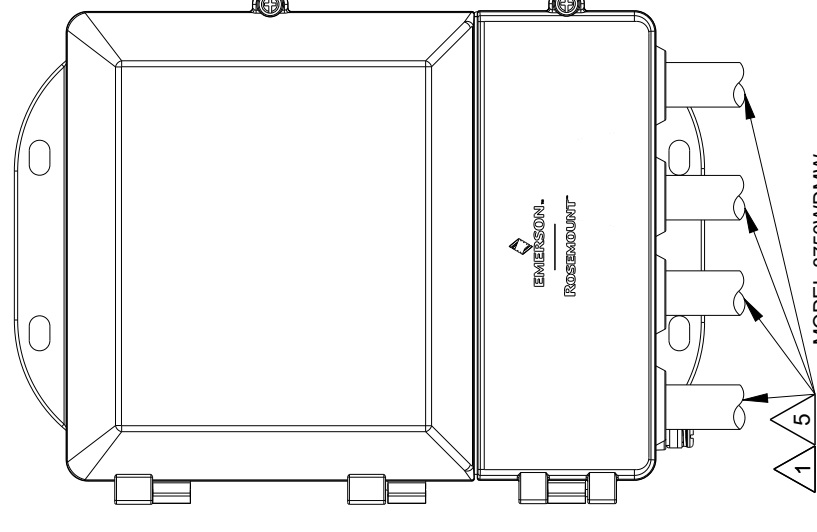

MODEL 8750WDMW  
WALL MOUNT  
Z1, Z7, AND Z9 OPTION

8750W-2052

DRAWING NO.

CONFIDENTIAL AND PROPRIETARY INFORMATION IS CONTAINED HEREIN AND MUST BE HANDLED ACCORDINGLY.	SURFACE FINISH UNLESS OTHERWISE SPECIFIED	125	3RD ANGLE	SIZE	C	SCALE	-	REV	AE
UNLESS OTHERWISE SPECIFIED DIMENSIONS IN INCHES (mm). REMOVE ALL BURRS AND SHARP EDGES.	<b>EMERSON</b> ROSEMOUNT								
-DEC TOLERANCES-	TITLE <b>INSTALLATION DRAWING 8750W, ATEX &amp; IECEX HAZARDOUS LOCATIONS</b>								
X ± .1 [2.5]	DR. J. LAGE 9/16/15 DRAWING NO. 8750W-2052								
.XX ± .02 [0.5]	APPD. M. MAYER 9/16/15								
.XXX ± .010 [0.25]	DO NOT SCALE PRINT   CAD MAINTAINED, (PROJ)   PRODUCT CODE   SHEET 3 OF 11								
FRACTIONS ± 1/32	ANGLES ± 2°								

\* TYPICAL APPLICATION. CONSULT LOCAL HAZARDOUS AREA (Ex) ZONING FOR PROCESS FLUID CLASSIFICATION.

# DUST ENVIRONMENT - EPL Dc SENSOR WITH ALLOWED INTEGRAL MOUNT EPL Dc TRANSMITTERS

## Ex tc SENSOR INTEGRAL MOUNT CONFIGURATIONS

MODEL 8750WD INTEGRAL MOUNT CONFIGURATION WITH SAFETY APPROVAL OPTION 'ND', 'NF'

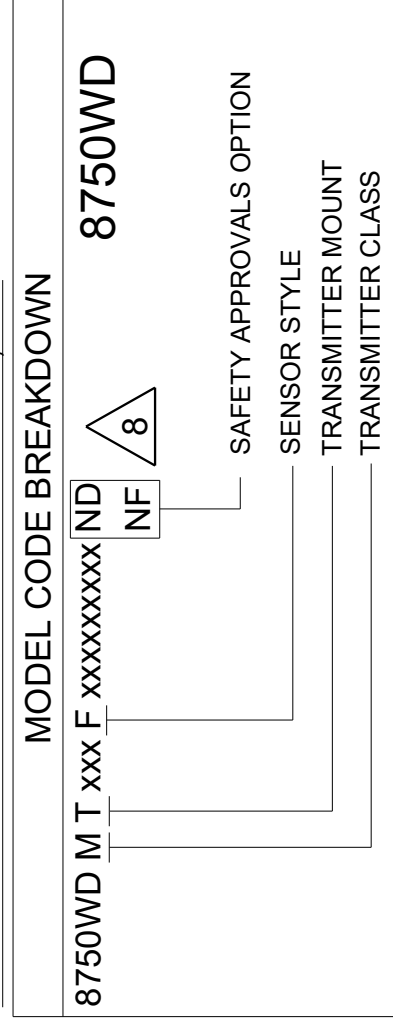

Ex tc IIIC T80°C...T130°C Dc EPL Dc, FOR USE IN ZONE 22 WITH CARBON STEEL HOUSING (-29°C ≤ Ta ≤ 60°C) SEE TABLE 2 FOR PROCESS TEMPERATURE LIMITS AND ALLOWED MOUNTING CONFIGURATION

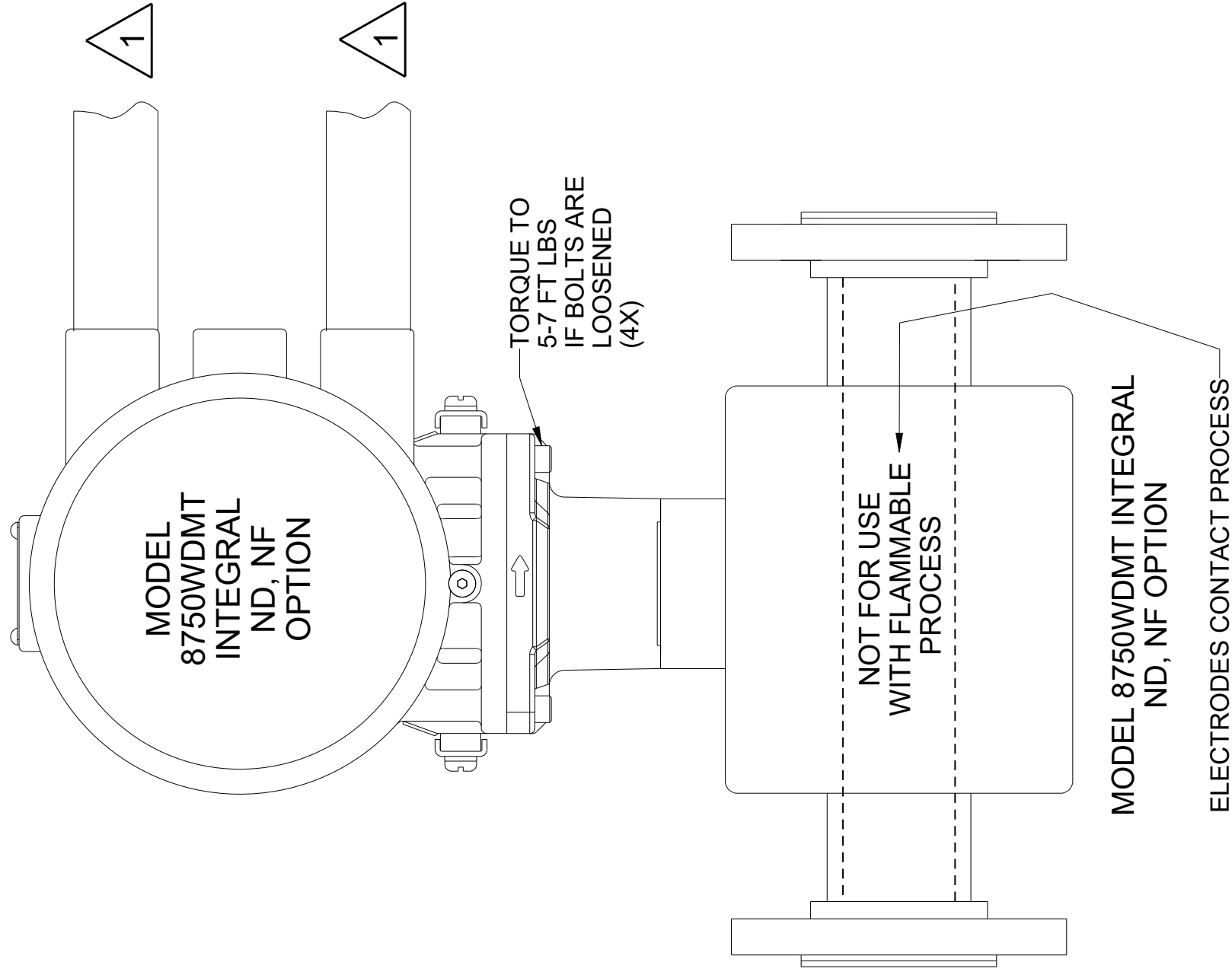

## ALLOWED INTEGRAL MOUNT TRANSMITTER CONFIGURATIONS

MODEL 8750WD INTEGRAL MOUNT CONFIGURATION WITH SAFETY APPROVAL OPTION 'ND', 'NF'

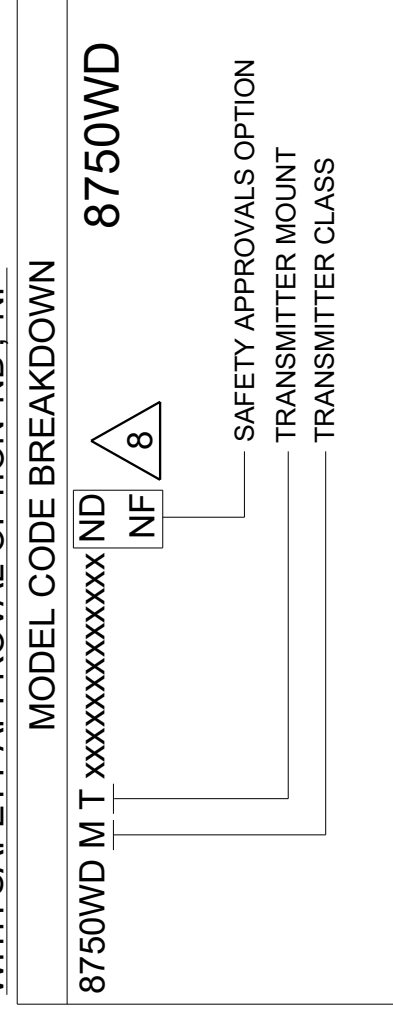

Ex tc IIIC T80°C...T130°C Dc EPL Dc, FOR USE IN ZONE 22 SEE TABLE 2 FOR TEMPERATURE CLASS AND SPECIFIED MAXIMUM SURFACE TEMPERATURE "T" OF FLOWTUBES ON WHICH THE TRANSMITTER IS MOUNTED

8750W-2052

DRAWING NO.

CONFIDENTIAL AND PROPRIETARY INFORMATION IS CONTAINED HEREIN AND MUST BE HANDLED ACCORDINGLY.	SURFACE FINISH UNLESS OTHERWISE SPECIFIED	125	3RD ANGLE	SIZE	C	SCALE	-	REV	AE
UNLESS OTHERWISE SPECIFIED DIMENSIONS IN INCHES (mm). REMOVE ALL BURRS AND SHARP EDGES.	EMERSON								
-DEC TOLERANCES- X ± .1 [2.5] .XX ± .02 [0.5] .XXX ± .010 [0.25] FRACTIONS ± 1/32 ANGLES ± 2°	TITLE								
	ROSEMOUNT								
	INSTALLATION DRAWING 8750W,								
	ATEX & IECEX HAZARDOUS LOCATIONS								
DR.	J. LAGE	9/16/15	DRAWING NO.	8750W-2052					
APPD	M. MAYER	9/16/15	PRODUCT CODE	DO NOT SCALE PRINT   CAD MAINTAINED, (PROJ)   SHEET 4 OF 11					



# DUST ENVIRONMENT - EPL Dc SENSOR WITH ALLOWED REMOTE MOUNT EPL Dc TRANSMITTERS

## Ex tc SENSOR REMOTE MOUNT CONFIGURATIONS

MODEL 8750WD REMOTE MOUNT SENSOR CONFIGURATION  
WITH SAFETY APPROVAL OPTION 'ND', 'NF'

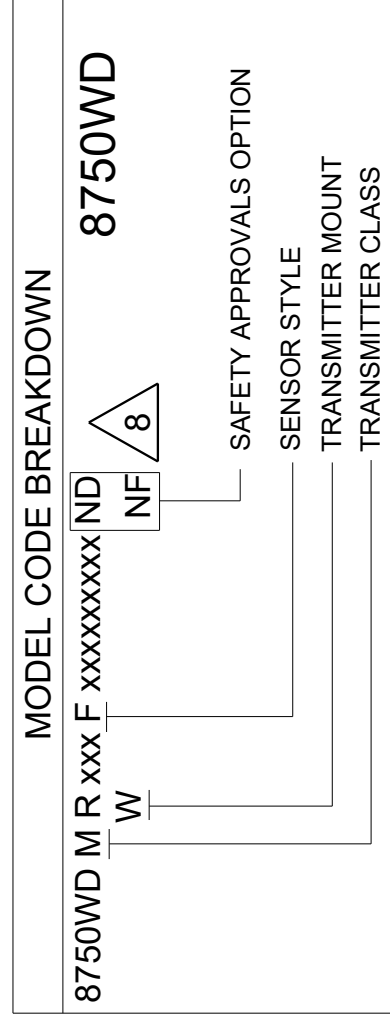

Ex tc IIIC T80°C...T130°C Dc  
EPL Dc, FOR USE IN ZONE 22  
WITH CARBON STEEL HOUSING (-29°C ≤ Ta ≤ 60°C)  
SEE TABLE 2 FOR PROCESS TEMPERATURE LIMITS  
AND ALLOWED MOUNTING CONFIGURATION

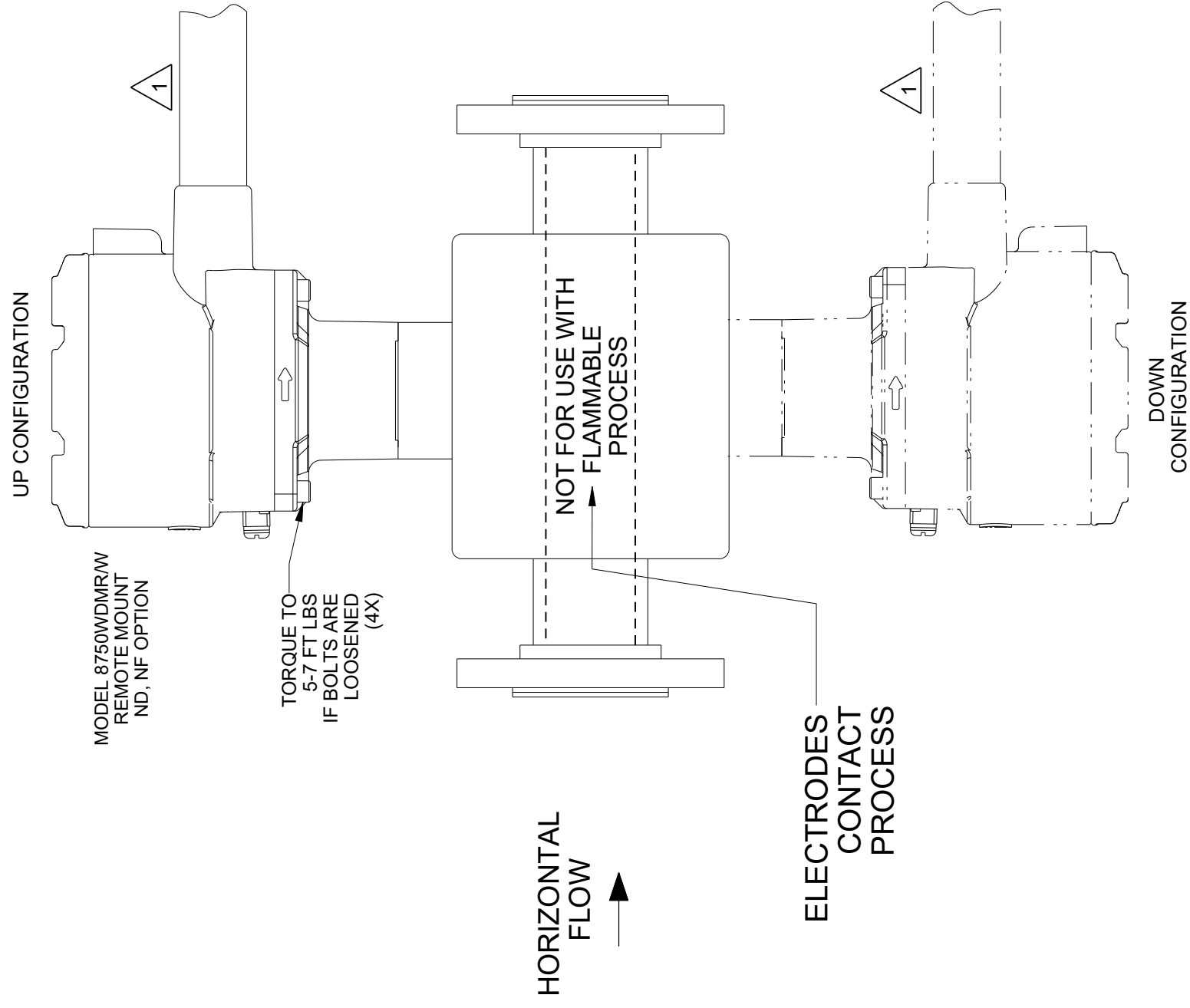

## ALLOWED REMOTE MOUNT TRANSMITTER CONFIGURATIONS

MODEL 8750WD REMOTE MOUNT CONFIGURATION  
WITH SAFETY APPROVAL OPTION 'ND', 'NF'

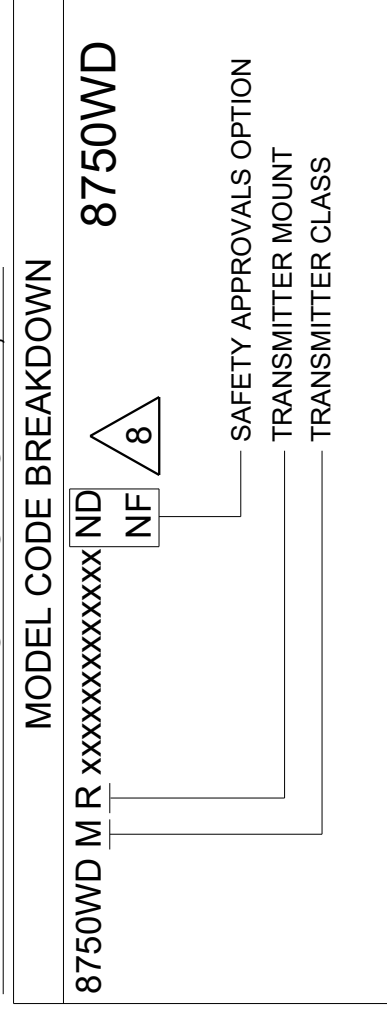

Ex tc IIIC T80°C...T130°C Dc  
EPL Dc, FOR USE IN ZONE 22  
REMOTE FIELD MOUNT TRANSMITTER MAXIMUM SURFACE  
TEMPERATURE T80°C (-40 ≤ Ta ≤ 60°C)

MODEL 8750WD REMOTE WALL MOUNT CONFIGURATION  
WITH SAFETY APPROVAL OPTION 'ND', 'NF'

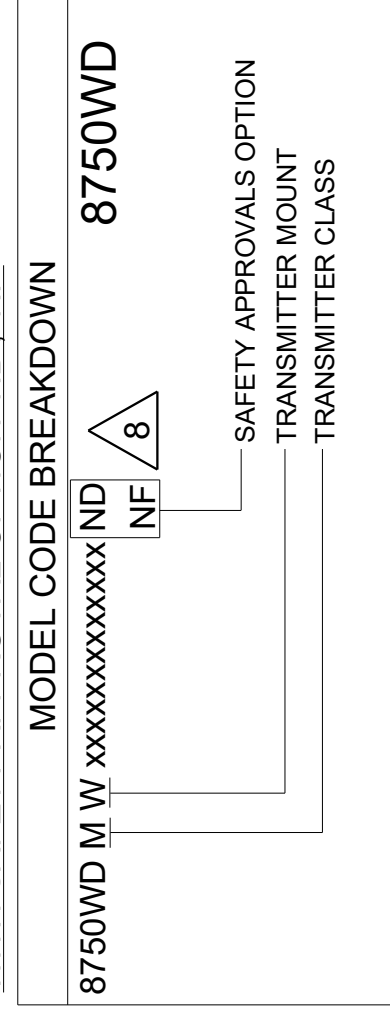

Ex tc IIIC T80°C Dc  
EPL Dc, FOR USE IN ZONE 22  
REMOTE WALL MOUNT TRANSMITTER MAXIMUM SURFACE  
TEMPERATURE T80°C (-40 ≤ Ta ≤ 60°C)

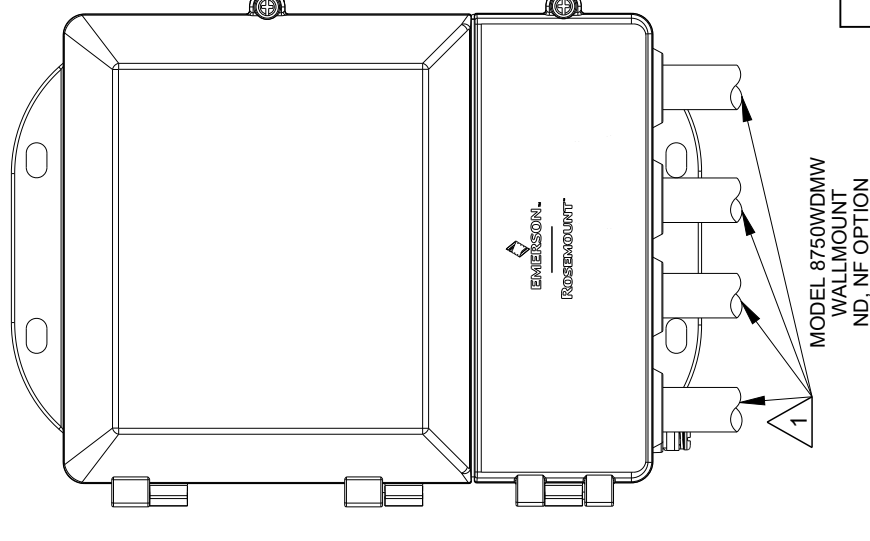
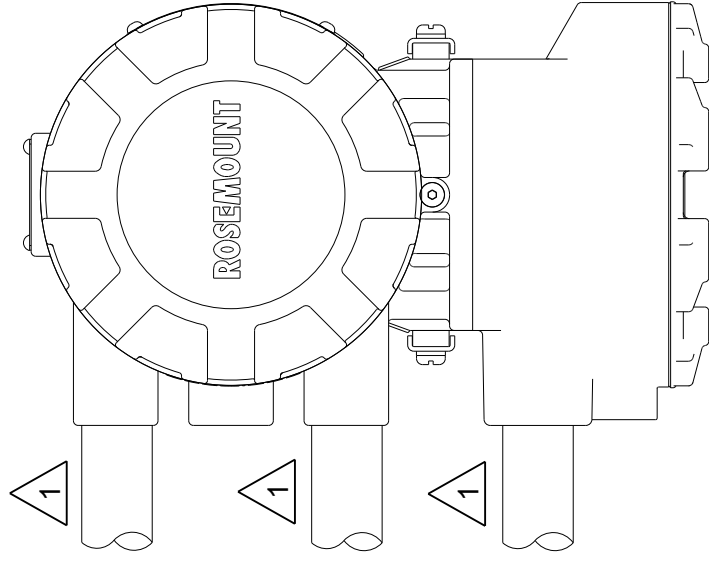

8750W-2052

DRAWING NO.

CONFIDENTIAL AND PROPRIETARY INFORMATION IS CONTAINED HEREIN AND MUST BE HANDLED ACCORDINGLY.	SURFACE FINISH UNLESS OTHERWISE SPECIFIED	125	3RD ANGLE	SIZE	C	SCALE	-	REV	AE
UNLESS OTHERWISE SPECIFIED DIMENSIONS IN INCHES (mm). REMOVE ALL BURRS AND SHARP EDGES.	EMERSON								
-DEC TOLERANCES- X ± .1 [2.5] .XX ± .02 [0.5] .XXX ± .010 [0.25] FRACTIONS ± 1/32 ANGLES ± 2°	ROSEMOUNT								
TITLE INSTALLATION DRAWING 8750W, ATEX & IECEX HAZARDOUS LOCATIONS									
DR.	J. LAGE	9/16/15	DRAWING NO.	8750W-2052					
APPD	M. MAYER	9/16/15	PRODUCT CODE	DO NOT SCALE PRINT   CAD MAINTAINED. (PROE)   SHEET 5 OF 11					

# GAS AND DUST ENVIRONMENT - EPL Gc AND EPL Dc - SENSOR TEMPERATURE CODE VS. PROCESS TEMPERATURE AND INGRESS PROTECTION RATINGS

**TABLE 1 - 8750W: Ex ec PROTECTION TYPE 'e' AND Ex nA PROTECTION TYPE 'n' SAFETY APPROVAL OPTION 'Z1', 'Z7', AND 'Z9' ALLOWED TRANSMITTER MOUNTING AND TEMPERATURE CODE VS. PROCESS TEMPERATURE**

LINE SIZE	MAXIMUM PROCESS TEMPERATURE (°C)	T CLASSIFICATION CODE	MOUNTING CONFIGURATION
ALL	60	T4	SENSOR WITH INTEGRAL MOUNT TRANSMITTER
ALL	90	T4	SENSOR WITH INTEGRAL MOUNT TRANSMITTER
ALL	60	T5	REMOTE SENSOR WITH REMOTE JUNCTION BOX (RJB)
ALL	90	T4	REMOTE SENSOR WITH REMOTE JUNCTION BOX (RJB)
ALL	120	T4	REMOTE SENSOR WITH REMOTE JUNCTION BOX (RJB)
ALL	NOT APPLICABLE	T4	REMOTE FIELD MOUNT TRANSMITTER
ALL	NOT APPLICABLE	T4	REMOTE WALLMOUNT TRANSMITTER

**TABLE 2 - 8750W: Ex tc PROTECTION TYPE 't' SAFETY APPROVAL OPTION 'ND', 'NF', 'Z1', 'Z7', AND 'Z9' ALLOWED TRANSMITTER MOUNTING AND TEMPERATURE CODE VS. PROCESS TEMPERATURE**

LINE SIZE	MAXIMUM PROCESS TEMPERATURE (°C)	MAXIMUM SURFACE TEMPERATURE	MOUNTING CONFIGURATION
ALL	60	T 80°C	SENSOR WITH INTEGRAL MOUNT TRANSMITTER
ALL	90	T 100°C	SENSOR WITH INTEGRAL MOUNT TRANSMITTER
ALL	60	T 80°C	REMOTE SENSOR WITH REMOTE JUNCTION BOX (RJB)
ALL	90	T 100°C	REMOTE SENSOR WITH REMOTE JUNCTION BOX (RJB)
ALL	120	T 130°C	REMOTE SENSOR WITH REMOTE JUNCTION BOX (RJB)
ALL	NOT APPLICABLE	T 80°C	REMOTE FIELD MOUNT TRANSMITTER
ALL	NOT APPLICABLE	T 80°C	REMOTE WALLMOUNT TRANSMITTER

**TABLE 3 - 8750W: INGRESS PROTECTION AND CORROSION PROTECTION RATINGS SAFETY APPROVAL OPTION 'ND', 'NF', 'Z1', 'Z7', AND 'Z9' ALLOWED TRANSMITTER MOUNTING AND PROTECTION RATINGS**

LINE SIZE	IP RATING	NEMA RATING	MOUNTING CONFIGURATION
ALL	IP66	TYPE 4X	SENSOR WITH INTEGRAL MOUNT TRANSMITTER
ALL	IP66	TYPE 4X	REMOTE FIELD MOUNT TRANSMITTER
ALL	IP66	TYPE 4X	REMOTE WALLMOUNT TRANSMITTER
ALL	IP66, IP68* or IP69K	TYPE 4X	REMOTE SENSOR WITH REMOTE JUNCTION BOX (RJB)

\* IP x8 submergence depth is 10 meters (30 feet) for 48 hours duration

CONFIDENTIAL AND PROPRIETARY INFORMATION IS CONTAINED HEREIN AND MUST BE HANDLED ACCORDINGLY.

UNLESS OTHERWISE SPECIFIED DIMENSIONS IN INCHES (mm). REMOVE ALL BURRS AND SHARP EDGES.

-DEC TOLERANCES-  
X ± .1 [2.5]  
XX ± .02 [0.5]  
XXX ± .010 [0.25]  
FRACTIONS ANGLES  
± 1/32 ± 2'



ROSEMOUNT

TITLE  
**INSTALLATION DRAWING 8750W, ATEX & IECEX HAZARDOUS LOCATIONS**

DR. J. LAGE 9/16/15 DRAWING NO. 8750W-2052  
APPD. M. MAYER 9/16/15

DO NOT SCALE PRINT CAD MAINTAINED (PROJ) PRODUCT CODE SHEET6 OF 11

8750W-2052  
DRAWING NO.

SURFACE FINISH UNLESS OTHERWISE SPECIFIED  
125  
3RD ANGLE  
SIZE C  
SCALE -  
REV AE

# GAS ENVIRONMENT- EPL Gc COIL AND ELECTRODE CIRCUIT WIRING

## MODEL 8750WD WITH INTRINSICALLY SAFE ELECTRODE CIRCUIT FOR USE WITH SAFETY APPROVAL OPTION Z1, Z7, AND Z9

COMPONENT CABLES ONLY. SEE TABLE BELOW FOR COMPATIBLE WIRING. SEE INSTALLATION WIRING DRAWING 08732-1504 FOR CABLING DETAILS. (FOR PROCESS TEMPERATURE LIMITS SEE TABLE 1)

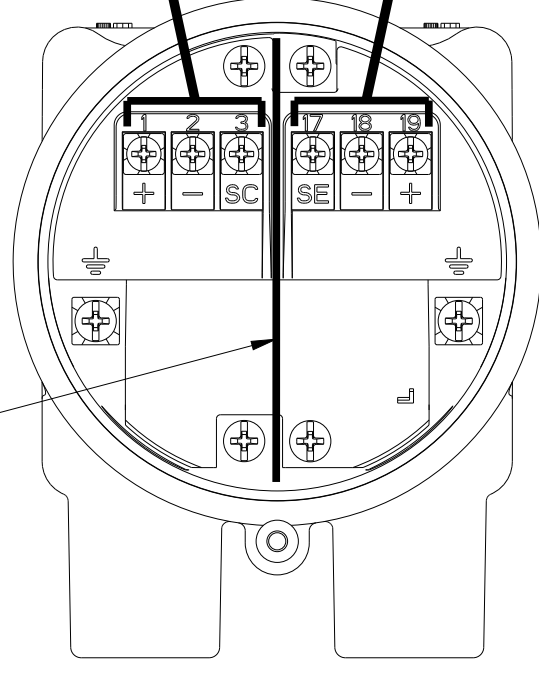

NON-INTRINSICALLY SAFE COIL CIRCUIT WIRING OPTIONS  
INSTALL AS Ex nA - "TYPE 'n' NON-SPARKING" OR  
INSTALL AS Ex ec - "TYPE 'e' INCREASED SAFETY"

INTRINSICALLY SAFE ELECTRODE CIRCUIT  
SEGREGATE FROM NON-INTRINSICALLY SAFE WIRING

8750WDMR/W FLOWTUBE  
REMOTE JUNCTION BOX

DIVIDER REQUIRED FOR  
INTRINSIC SAFETY (Ex i)

8750WDMR TRANSMITTER  
REMOTE JUNCTION BOX

## MODEL 8750WD WITH INTRINSICALLY SAFE ELECTRODE CIRCUIT FOR USE WITH SAFETY APPROVAL OPTION Z1, Z7, AND Z9

COMPONENT CABLES ONLY. SEE TABLE BELOW FOR COMPATIBLE WIRING. SEE INSTALLATION WIRING DRAWING 08712-1504 FOR CABLING DETAILS. (FOR PROCESS TEMPERATURE LIMITS SEE TABLE 1)

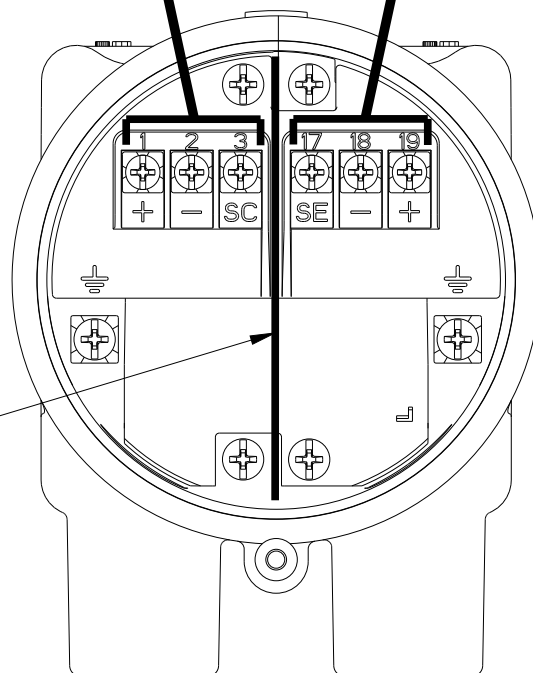

NON-INTRINSICALLY SAFE COIL CIRCUIT WIRING OPTIONS:  
INSTALL AS Ex nA - "TYPE 'n' NON-SPARKING" OR  
INSTALL AS Ex ec - "TYPE 'e' INCREASED SAFETY"

INTRINSICALLY SAFE ELECTRODE CIRCUIT  
SEGREGATE FROM NON-INTRINSICALLY SAFE WIRING

8750WDMR/W FLOWTUBE  
REMOTE JUNCTION BOX

8750WDMW TRANSMITTER  
(LOWER COVER AND SAFETY COVER ARE NOT SHOWN)

ENTITY CONCEPT FOR INTRINSICALLY SAFE ELECTRODE INSTALLATION

## SYSTEM APPROVAL FOR INTRINSICALLY SAFE ELECTRODE INSTALLATION

THE MODEL 8750WD MAGNETIC FLOWMETER REFERENCING CONTROL DRAWING 8750W-2052 MAY USE UP TO 500 FEET (150 METERS) OF ROSEMOUNT SUPPLIED ELECTRODE CABLING FOR INTERCONNECTION OF THE DEVICES. THE CORRECT CABLING IS SUPPLIED AS PART OF THE FOLLOWING ROSEMOUNT CABLING KITS:

COIL AND INTRINSICALLY SAFE ELECTRODE COMPONENT CABLES:

ROSEMOUNT PART NO.	UNIT OF MEASURE	TEMPERATURE RANGE	SEE NOTE
08732-0065-0003	FEET	-20° C TO 75° C	10
08732-0065-0004	METERS	-20° C TO 75° C	
08732-0065-1003	FEET	-50° C TO 125° C	
08732-0065-1004	METERS	-50° C TO 125° C	

INDIVIDUAL OR REPLACEMENT INTRINSICALLY SAFE ELECTRODE COMPONENT CABLES:

ROSEMOUNT PART NO.	UNIT OF MEASURE	TEMPERATURE RANGE	SEE NOTE
08732-0061-0003	FEET	-20° C TO 75° C	10
08732-0061-0004	METERS	-20° C TO 75° C	
08732-0061-1003	FEET	-50° C TO 125° C	
08732-0061-1004	METERS	-50° C TO 125° C	

TERMINAL	LABEL
REMOTE MOUNT FLOWTUBE AND TRANSMITTER TERMINAL LAYOUT	
INTRINSICALLY SAFE ELECTRODE CIRCUIT	
19	ELECTRODE +
18	ELECTRODE -
17	ELECTRODE REFERENCE (SE)
NON-INTRINSICALLY SAFE COIL CIRCUIT	
1	COIL +
2	COIL -
3	COIL SHIELD (SC)

TERMINAL	LABEL
REMOTE MOUNT FLOWTUBE AND TRANSMITTER LAYOUT	
INTRINSICALLY SAFE ELECTRODE CIRCUIT	
19	ELECTRODE +
18	ELECTRODE -
17	ELECTRODE REFERENCE (SE)
NON-INTRINSICALLY SAFE COIL CIRCUIT	
1	COIL +
2	COIL -
3	COIL SHIELD (SC)

TERMINALS 19, 18, AND 17 CONTAIN TWO CHANNELS OF AN INTRINSICALLY SAFE CIRCUIT WITH A COMMON RETURN. ENTITY PARAMETERS SHOWN BELOW ARE THE SUMMATION OF BOTH CHANNELS.

TRANSMITTER ENTITY PARAMETERS  
MODEL: 8750WDMT, 8750WDMR, AND 8750WDMW  
INTRINSICALLY SAFE ELECTRODE CIRCUIT  
REMOTE JUNCTION BOX TERMINALS 19, 18, 17  
 $U_o = 28.56V$   
 $I_o = 5.77mA$   
 $P_o = 165mW$   
 $C_o = 61.7nF$   
 $L_o = 1.0H$

FLOW TUBE ENTITY PARAMETERS  
MODEL: 8750WDMxxxxF  
INTRINSICALLY SAFE ELECTRODE CIRCUIT  
REMOTE JUNCTION BOX TERMINALS 19, 18, 17  
 $U_i = 30V$   
 $I_i = 50mA$   
 $P_i = 1.0W$   
 $C_i = 1.9nF$   
 $L_i = 630\mu H$

THE ENTITY CONCEPT ALLOWS INTERCONNECTION OF ASSOCIATED APPARATUS AND INTRINSICALLY SAFE APPARATUS WHEN THE FOLLOWING IS TRUE:

$U_o \leq U_i$ ,  $I_o \leq I_i$ ,  $P_o \leq P_i$ ,  $C_o \geq C_i + C_{cable}$ ,  $L_o \geq L_i + L_{cable}$   
 THE ALLOWED CAPACITANCE,  $C_o$  IS SHARED BETWEEN THE CIRCUITS OF TERMINALS 19, 18, AND 17. CABLE CAPACITANCE MUST BE ASSESSED AS TWICE THE MEASURED VALUE PER LENGTH OF CABLE.

EXAMPLE 1: THE HIGHEST MEASURED CAPACITANCE OF A 3 CONDUCTOR, SHIELDED CABLE IS 58pF/ft WHEN MEASURED CONDUCTOR TO CONDUCTOR TIED TO SHIELD.

$C_{cable} = 2 \times 58pF/ft \times \text{FEET OF CABLE}$   
 $C_i + C_{cable} < C_o$   
 CABLE LENGTH MUST BE UNDER 515 FEET

CONFIDENTIAL AND PROPRIETARY INFORMATION IS CONTAINED HEREIN AND MUST BE HANDLED ACCORDINGLY.

UNLESS OTHERWISE SPECIFIED DIMENSIONS IN INCHES (mm). REMOVE ALL BURRS AND SHARP EDGES.

-DEC TOLERANCES-	ANGLES
X ± .1 (2.5)	± 2°
.XX ± .02 (0.5)	
.XXX ± .010 (0.25)	
FRACTIONS ± 1/32	



TITLE  
**INSTALLATION DRAWING 8750W, ATEX & IECEX HAZARDOUS LOCATIONS**

DR. J. LAGE 9/16/15 DRAWING NO. 8750W-2052  
 APPD. M. MAYER 9/16/15

ROSEMOUNT

SURFACE FINISH UNLESS OTHERWISE SPECIFIED

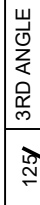

3RD ANGLE

SCALE

SIZE C

REV AE

8750W-2052

DRAWING NO.

# DUST ENVIRONMENT - EPL Dc COIL AND ELECTRODE CIRCUIT WIRING

MODEL 8750WD WITH NON-INTRINSICALLY SAFE ELECTRODE CIRCUIT  
 FOR USE WITH SAFETY APPROVAL OPTION Z1, Z7, AND Z9  
 COMPONENT OR COMBINATION COIL/ELECTRODE CABLE ALLOWED.  
 SEE INSTALLATION WIRING DRAWING 08732-1504 FOR NON-INTRINSICALLY SAFE CABLING  
 (FOR PROCESS TEMPERATURE LIMITS SEE TABLE 2)

OPTIONAL DIVIDER SHOWN

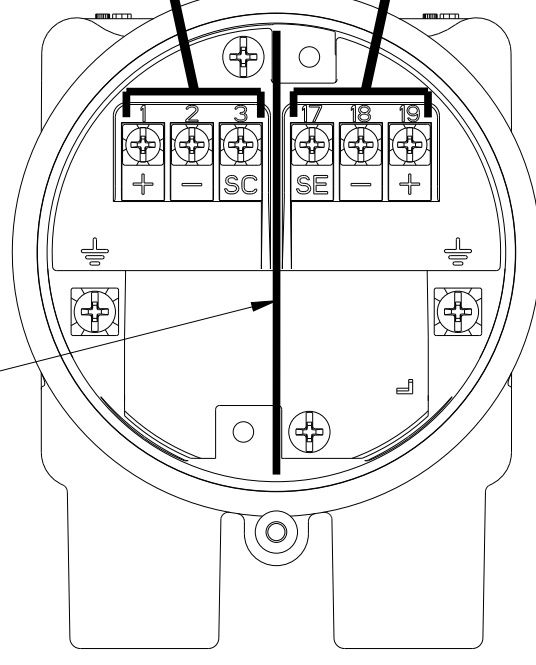

NON-INTRINSICALLY SAFE COIL CIRCUIT  
 INSTALL USING EPL Dc WIRING  
 METHODS APPROPRIATE TO THE AREA DEVICE  
 IS INSTALLED IN

FOR USE WITH NON-FLAMMABLE PROCESS ONLY.  
 INSTALL ELECTRODE CIRCUIT AS NON-INTRINSICALLY SAFE  
 USING EPL Dc WIRING METHODS APPROPRIATE  
 TO THE AREA DEVICE IS INSTALLED IN.

8750WDMR/W FLOWTUBE  
 REMOTE JUNCTION BOX

REMOTE MOUNT FLOWTUBE AND TRANSMITTER LAYOUT	
TERMINAL	LABEL
NON-INTRINSICALLY SAFE ELECTRODE CIRCUIT	
19	ELECTRODE +
18	ELECTRODE -
17	ELECTRODE REFERENCE (SE)
NON-INTRINSICALLY SAFE COIL CIRCUIT	
1	COIL +
2	COIL -
3	COIL SHIELD (SC)

OPTIONAL DIVIDER SHOWN

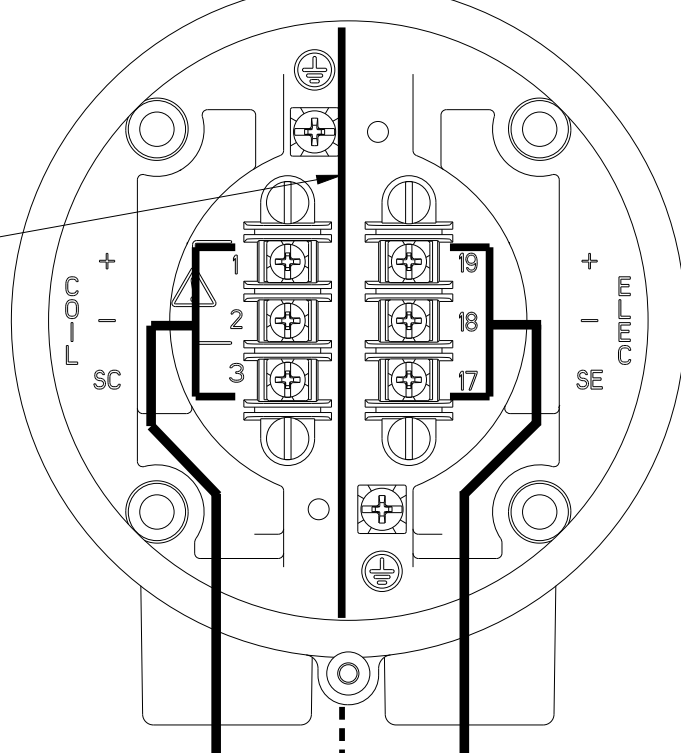

8750WDMR TRANSMITTER  
 REMOTE JUNCTION BOX

MODEL 8750WD WITH NON-INTRINSICALLY SAFE ELECTRODE CIRCUIT  
 FOR USE WITH SAFETY APPROVAL OPTION Z1, Z7, AND Z9  
 COMPONENT OR COMBINATION COIL/ELECTRODE CABLE ALLOWED.  
 SEE INSTALLATION WIRING DRAWING 08712-1504 FOR NON-INTRINSICALLY SAFE CABLING  
 (FOR PROCESS TEMPERATURE LIMITS SEE TABLE 2)

OPTIONAL DIVIDER SHOWN

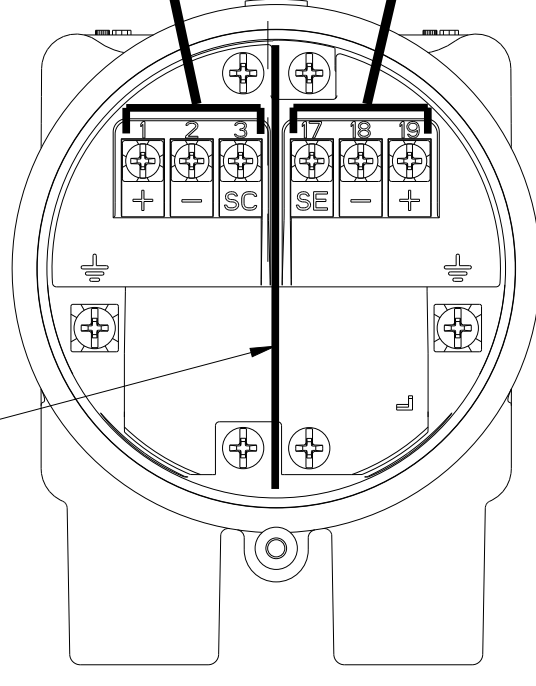

NON-INTRINSICALLY SAFE COIL CIRCUIT  
 INSTALL USING EPL Dc WIRING  
 METHODS APPROPRIATE TO THE AREA  
 DEVICE IS INSTALLED IN

FOR USE WITH NON-FLAMMABLE PROCESS ONLY.  
 INSTALL ELECTRODE CIRCUIT AS NON-INTRINSICALLY SAFE  
 USING EPL Dc WIRING METHODS APPROPRIATE  
 TO THE AREA DEVICE IS INSTALLED IN.

8750WDMR/W FLOWTUBE  
 REMOTE JUNCTION BOX

REMOTE MOUNT FLOWTUBE AND TRANSMITTER LAYOUT	
TERMINAL	LABEL
NON-INTRINSICALLY SAFE ELECTRODE CIRCUIT	
19	ELECTRODE +
18	ELECTRODE -
17	ELECTRODE REFERENCE (SE)
NON-INTRINSICALLY SAFE COIL CIRCUIT	
1	COIL +
2	COIL -
3	COIL SHIELD (SC)

OPTIONAL  
 DIVIDERS SHOWN

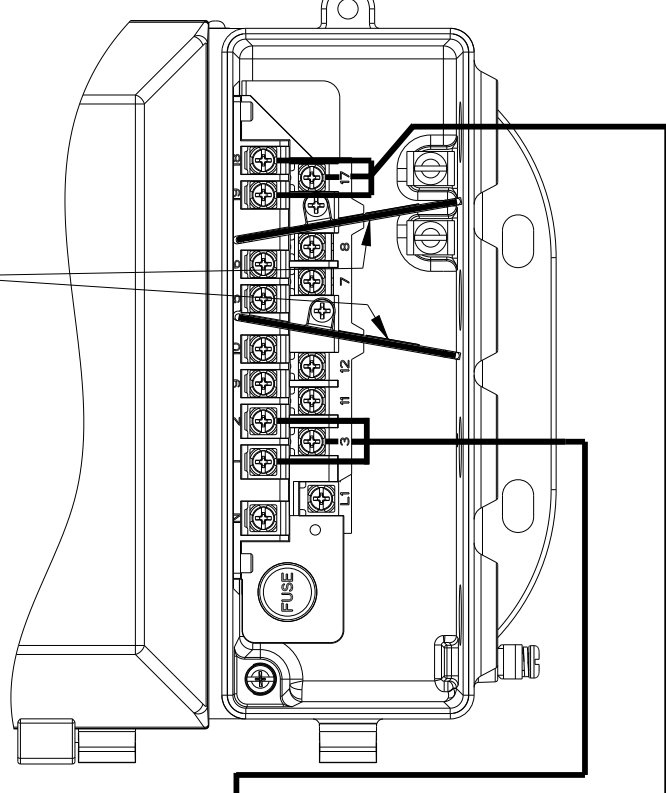

8750WDMW TRANSMITTER  
 (LOWER COVER AND SAFETY COVER ARE NOT SHOWN)

8750W-2052  
 DRAWING NO.

CONFIDENTIAL AND PROPRIETARY INFORMATION IS CONTAINED HEREIN AND MUST BE HANDLED ACCORDINGLY.	SURFACE FINISH UNLESS OTHERWISE SPECIFIED	125°	3RD ANGLE	SIZE	C	SCALE	-	REV	AE
	EMERSON								
UNLESS OTHERWISE SPECIFIED DIMENSIONS IN INCHES (mm). REMOVE ALL BURRS AND SHARP EDGES.	ROSEMOUNT								
	TITLE INSTALLATION DRAWING 8750W, ATEX & IECEX HAZARDOUS LOCATIONS								
DR.	J. LAGE	9/16/15	DRAWING NO.	8750W-2052					
APPD.	M. MAYER	9/16/15	PRODUCT CODE	DO NOT SCALE PRINT   CAD MAINTAINED. (PROE)   SHEET 8 OF 11					

# GAS AND DUST ENVIRONMENT - OUTPUT WIRING

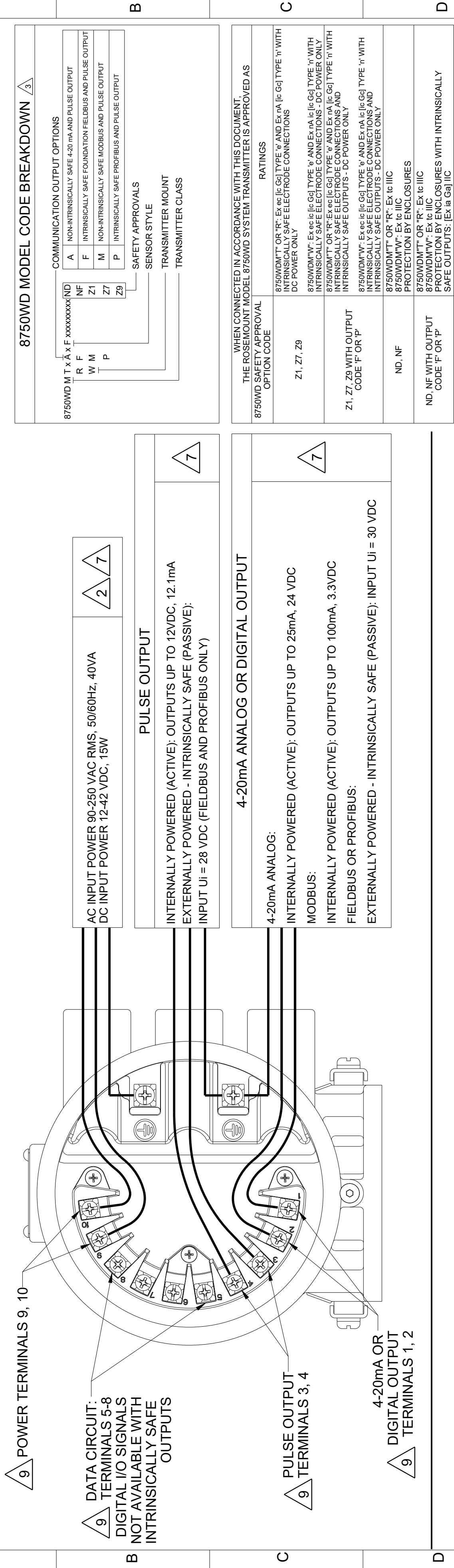

**8750WD MODEL CODE BREAKDOWN**

8750WD M T X A F xxxxxxxxND	COMMUNICATION OUTPUT OPTIONS
R F	A NON-INTRINSICALLY SAFE 4-20 mA AND PULSE OUTPUT
W M	F INTRINSICALLY SAFE FOUNDATION FIELDBUS AND PULSE OUTPUT
P	M NON-INTRINSICALLY SAFE MODBUS AND PULSE OUTPUT
	Z1 Z7 Z9
	P INTRINSICALLY SAFE PROFIBUS AND PULSE OUTPUT

SAFETY APPROVALS:  
 SENSOR STYLE  
 TRANSMITTER MOUNT  
 TRANSMITTER CLASS

WHEN CONNECTED IN ACCORDANCE WITH THIS DOCUMENT, THE ROSEMOUNT MODEL 8750WD SYSTEM TRANSMITTER IS APPROVED AS

8750WD SAFETY APPROVAL OPTION CODE	RATINGS
Z1, Z7, Z9	8750WDM"TT" OR "R": Ex ec [ic Gg] TYPE 's' AND Ex nA [ic Gg] TYPE 'n' WITH DC POWER ONLY 8750WDM"W": Ex ec [ic Gg] TYPE 's' AND Ex nA [ic Gg] TYPE 'n' WITH INTRINSICALLY SAFE ELECTRODE CONNECTIONS - DC POWER ONLY 8750WDM"TT" OR "R": Ex ec [ic Gg] TYPE 's' AND Ex nA [ic Gg] TYPE 'n' WITH INTRINSICALLY SAFE ELECTRODE CONNECTIONS - DC POWER ONLY 8750WDM"W": Ex ec [ic Gg] TYPE 's' AND Ex nA [ic Gg] TYPE 'n' WITH INTRINSICALLY SAFE ELECTRODE CONNECTIONS AND INTRINSICALLY SAFE OUTPUTS - DC POWER ONLY 8750WDM"TT" OR "R": Ex ec [ic Gg] TYPE 's' AND Ex nA [ic Gg] TYPE 'n' WITH INTRINSICALLY SAFE ELECTRODE CONNECTIONS AND INTRINSICALLY SAFE OUTPUTS - DC POWER ONLY 8750WDM"W": Ex ec [ic Gg] TYPE 's' AND Ex nA [ic Gg] TYPE 'n' WITH INTRINSICALLY SAFE ELECTRODE CONNECTIONS AND INTRINSICALLY SAFE OUTPUTS - DC POWER ONLY
ND, NF	8750WDM"TT" OR "R": Ex ic IIIC 8750WDM"W": Ex ic IIIC PROTECTION BY ENCLOSURES
ND, NF WITH OUTPUT CODE 'F' OR 'P'	8750WDM"TT" OR "R": Ex ic IIIC 8750WDM"W": Ex ic IIIC PROTECTION BY ENCLOSURES WITH INTRINSICALLY SAFE OUTPUTS: [Ex ia Gg] IIC

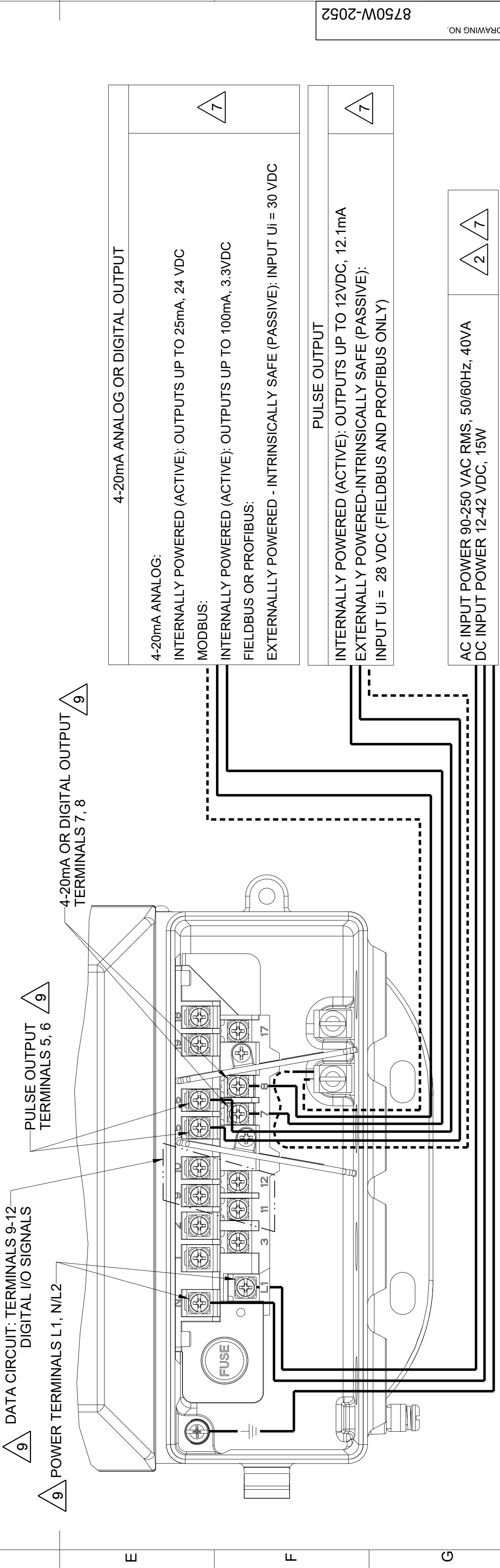

CONFIDENTIAL AND PROPRIETARY INFORMATION IS CONTAINED HEREIN AND MUST BE HANDLED ACCORDINGLY.

UNLESS OTHERWISE SPECIFIED DIMENSIONS IN INCHES (mm). REMOVE ALL BURRS AND SHARP EDGES.

-DEC TOLERANCES-  
 X ± .1 [2.5]  
 .XX ± .02 [0.5]  
 .XXX ± .010 [0.25]  
 FRACTIONS ± 1/32 ANGLES ± 2°

EMERSON  
 TITLE: INSTALLATION DRAWING 8750W,  
 ATEX & IECEx HAZARDOUS LOCATIONS

DR: J. LAGE 9/16/15 DRAWING NO. 8750W-2052  
 APPD: M. MAYER 9/16/15

DO NOT SCALE PRINT | CAD MAINTAINED: (PROJ) | PRODUCT CODE | SHEET9 OF 11

ROSEMOUNT

8750W-2052

REVISIONS: SCALE: SIZE: C 3RD ANGLE SURFACE FINISH UNLESS OTHERWISE SPECIFIED 125/ REV: AE

# GAS ENVIRONMENT - INTRINSICALLY SAFE ENTITY CONCEPTS

## 8750WDMT/R ENTITY CONCEPT FOR INTRINSICALLY SAFE OUTPUTS

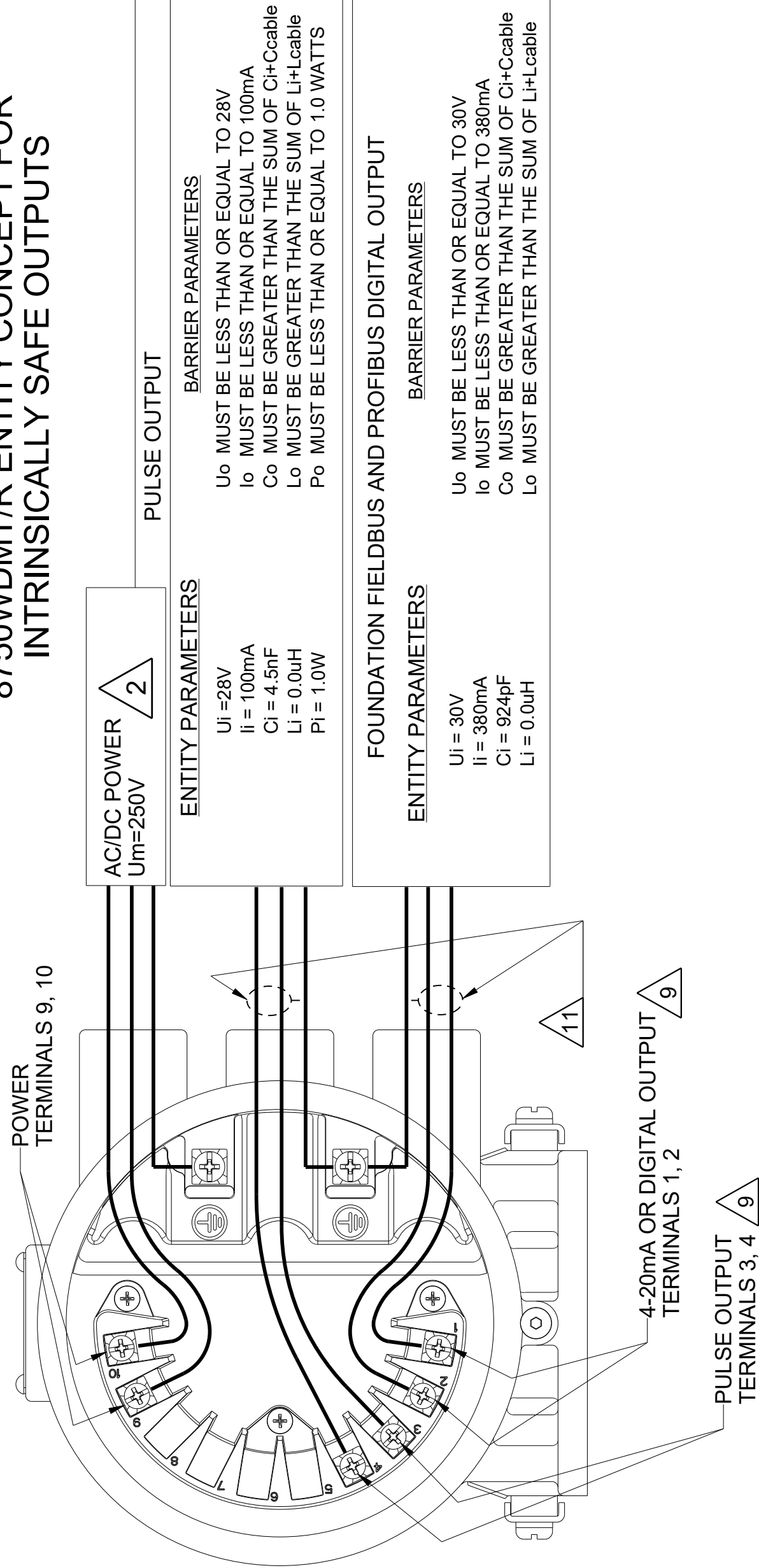

**DEFINITIONS:**

- U<sub>i</sub> = MAXIMUM INPUT VOLTAGE
- I<sub>i</sub> = MAXIMUM INPUT CURRENT
- C<sub>i</sub> = MAXIMUM INTERNAL CAPACITANCE
- L<sub>i</sub> = MAXIMUM INTERNAL INDUCTANCE
- P<sub>i</sub> = MAXIMUM INPUT POWER
- U<sub>o</sub> = OPEN CIRCUIT VOLTAGE OF THE BARRIER
- I<sub>o</sub> = SHORT CIRCUIT CURRENT OF THE BARRIER
- C<sub>o</sub> = MAXIMUM ALLOWED CAPACITANCE
- L<sub>o</sub> = MAXIMUM ALLOWED INDUCTANCE
- P<sub>o</sub> = MAXIMUM OUTPUT POWER

THE ENTITY CONCEPT ALLOWS INTERCONNECTION OF ASSOCIATED APPARATUS AND INTRINSICALLY SAFE APPARATUS WHEN THE FOLLOWING IS TRUE:  
 $U_o \leq U_i$ ,  $I_o \leq I_i$ ,  $P_o \leq P_i$ ,  $C_o \geq C_i + C_{\text{cable}}$ ,  $L_o \geq L_i + L_{\text{cable}}$

## 8750WDMW ENTITY CONCEPT FOR INTRINSICALLY SAFE OUTPUTS

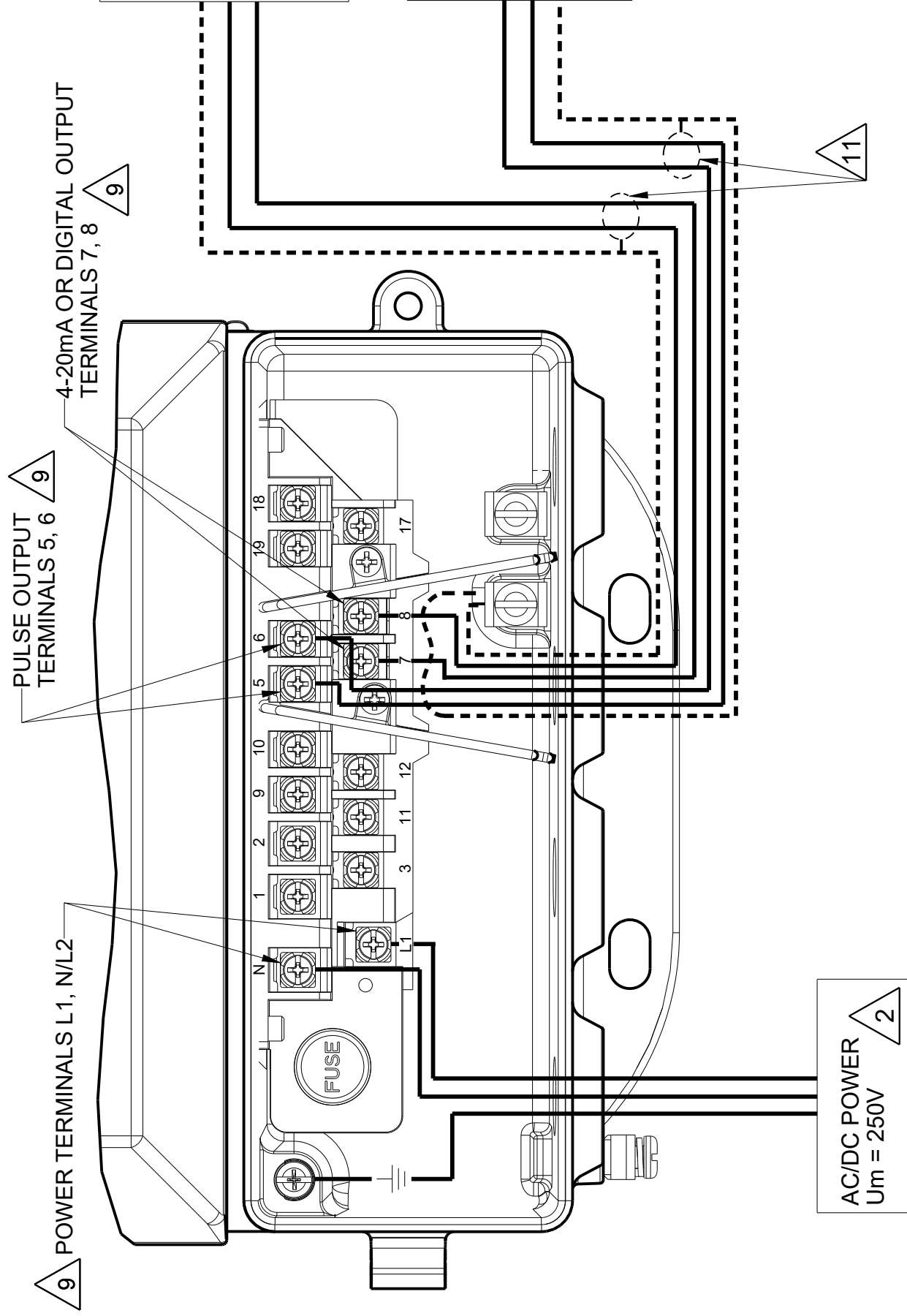

**FOUNDATION FIELDBUS AND PROFIBUS DIGITAL OUTPUT**

**ENTITY PARAMETERS**

U<sub>i</sub> = 30V  
 I<sub>i</sub> = 380mA  
 C<sub>i</sub> = 924pF  
 L<sub>i</sub> = 0.0uH

**BARRIER PARAMETERS**

U<sub>o</sub> MUST BE LESS THAN OR EQUAL TO 30V  
 I<sub>o</sub> MUST BE LESS THAN OR EQUAL TO 380mA  
 C<sub>o</sub> MUST BE GREATER THAN THE SUM OF C<sub>i</sub>+C<sub>cable</sub>  
 L<sub>o</sub> MUST BE GREATER THAN THE SUM OF L<sub>i</sub>+L<sub>cable</sub>

**FOUNDATION FIELDBUS AND PROFIBUS DIGITAL OUTPUT**

**ENTITY PARAMETERS**

U<sub>i</sub> = 28V  
 I<sub>i</sub> = 100mA  
 C<sub>i</sub> = 4.5nF  
 L<sub>i</sub> = 0.0uH  
 P<sub>i</sub> = 1.0W

**BARRIER PARAMETERS**

U<sub>o</sub> MUST BE LESS THAN OR EQUAL TO 28V  
 I<sub>o</sub> MUST BE LESS THAN OR EQUAL TO 100mA  
 C<sub>o</sub> MUST BE GREATER THAN THE SUM OF C<sub>i</sub>+C<sub>cable</sub>  
 L<sub>o</sub> MUST BE GREATER THAN THE SUM OF L<sub>i</sub>+L<sub>cable</sub>  
 P<sub>o</sub> MUST BE LESS THAN OR EQUAL TO 1.0 WATTS

CONFIDENTIAL AND PROPRIETARY INFORMATION IS CONTAINED HEREIN AND MUST BE HANDLED ACCORDINGLY.	SURFACE FINISH UNLESS OTHERWISE SPECIFIED	125	3RD ANGLE	SIZE	SCALE	REV
				C	-	AE
<b>EMERSON</b>						
TITLE <b>ROSEMOUNT</b>						
INSTALLATION DRAWING 8750W, ATEX & IECx HAZARDOUS LOCATIONS						
UNLESS OTHERWISE SPECIFIED DIMENSIONS IN INCHES (mm). REMOVE ALL BURRS AND SHARP EDGES.	-DEC TOLERANCES-					
X ± .1 [2.5]	.XX ± .02 [0.5]					
.XXX ± .010 [0.25]	FRACTIONS ± 1/32	ANGLES ± 2°				
DO NOT SCALE PRINT	CAD MAINTAINED: (PROJ)	APPD	M. MAYER	9/16/15	DRAWING NO.	8750W-2052
FORM REV A0	SHEET 10	OF 11				



# GAS ENVIRONMENT - FISCO CONCEPT

## FISCO CONCEPT

THE FISCO CONCEPT ALLOWS INTERCONNECTION OF INTRINSICALLY SAFE APPARATUS TO ASSOCIATED APPARATUS NOT SPECIALLY EXAMINED IN SUCH COMBINATION. THE CRITERIA FOR INTERCONNECTION IS THAT THE VOLTAGE ( $V_{max}$ ), THE CURRENT ( $I_{max}$ ), AND THE POWER ( $P_{max}$ ) WHICH AN INTRINSICALLY SAFE APPARATUS CAN RECEIVE AND REMAIN INTRINSICALLY SAFE CONSIDERING FAULTS, MUST BE EQUAL OR GREATER THAN VOLTAGE ( $V_{oc}$ ), AND CURRENT ( $I_{sc}$ ) WHICH CAN BE DELIVERED BY THE ASSOCIATED APPARATUS, CONSIDERING FAULTS AND APPLICABLE FACTORS. IN ADDITION, THE MAXIMUM UNPROTECTED CAPACITANCE ( $C_i$ ) AND THE INDUCTANCE ( $L_i$ ) OF EACH APPARATUS (OTHER THAN THE TERMINATION) CONNECTED TO THE FIELDBUS MUST BE LESS THAN OR EQUAL TO 5 nF AND 10 uH RESPECTIVELY.

IN EACH SEGMENT ONLY ONE ACTIVE DEVICE, NORMALLY THE ASSOCIATED APPARATUS, IS ALLOWED TO PROVIDE THE NECESSARY ENERGY FOR THE FIELDBUS SYSTEM. THE VOLTAGE ( $V_{oc}$ ) OF THE ASSOCIATED APPARATUS IS LIMITED TO A RANGE OF 14 TO 17.5 VDC. ALL OTHER EQUIPMENT CONNECTED TO THE BUS CABLE HAS TO BE PASSIVE, MEANING THAT THEY ARE NOT ALLOWED TO PROVIDE ENERGY TO THE SYSTEM, EXCEPT A LEAKAGE CURRENT OF 50 uA FOR EACH CONNECTED DEVICE. SEPARATELY POWERED EQUIPMENT NEEDS GALVANIC ISOLATION TO ASSURE THAT THE INTRINSICALLY SAFE FIELDBUS CIRCUIT REMAINS PASSIVE.

THE CABLE USED TO INTERCONNECT DEVICES NEEDS TO HAVE THE PARAMETERS IN THE FOLLOWING RANGE:

Loop Resistance  $R_c$ : 15.....150 Ohm/km  
 Inductance per unit length  $L_c$ : 0.4.....1 mH/km  
 Capacitance per unit length  $C_c$ : 45.....200 nF  
 Length of trunk cable: less than or equal to 1000m  
 Length of spur cable: less than or equal to 60m

AT EACH END OF THE TRUNK CABLE AN APPROVED INFALLIBLE LINE TERMINATION WITH THE FOLLOWING PARAMETERS IS SUITABLE.

$R = 90.....102 \text{ Ohm}$        $C = 0.....2.2 \text{ } \mu\text{f}$

ONE OF THE ALLOWED TERMINATIONS MIGHT ALREADY BE INTEGRATED IN THE ASSOCIATED APPARATUS. THE NUMBER OF PASSIVE APPARATUS CONNECTED TO THE BUS SEGMENT IS NOT LIMITED TO I.S. REASONS. IF THE ABOVE RULES ARE RESPECTED, UP TO A TOTAL LENGTH OF 1000 m (SUM OF TRUNK AND ALL SPUR CABLES) OF CABLE IS PERMITTED. THE INDUCTANCE AND THE CAPACITANCE OF THE CABLE WILL NOT IMPAIR THE INTRINSIC SAFETY OF THE INSTALLATION.

### ENTITY PARAMETER

$U_i = 30V$   
 $I_i = 380 \text{ mA}$   
 $C_i = 924 \text{ pF}$   
 $L_i = 0.0 \text{ uH}$   
 $P_i = 5.32 \text{ W}$

### BARRIER PARAMETERS

$U_o$  MUST BE LESS THAN OR EQUAL TO 30V  
 $I_o$  MUST BE LESS THAN OR EQUAL TO 380 mA  
 $C_o$  MUST BE GREATER THAN THE SUM OF  $C_i + C_{cable}$   
 $L_o$  MUST BE GREATER THAN THE SUM OF  $L_i + L_{cable}$

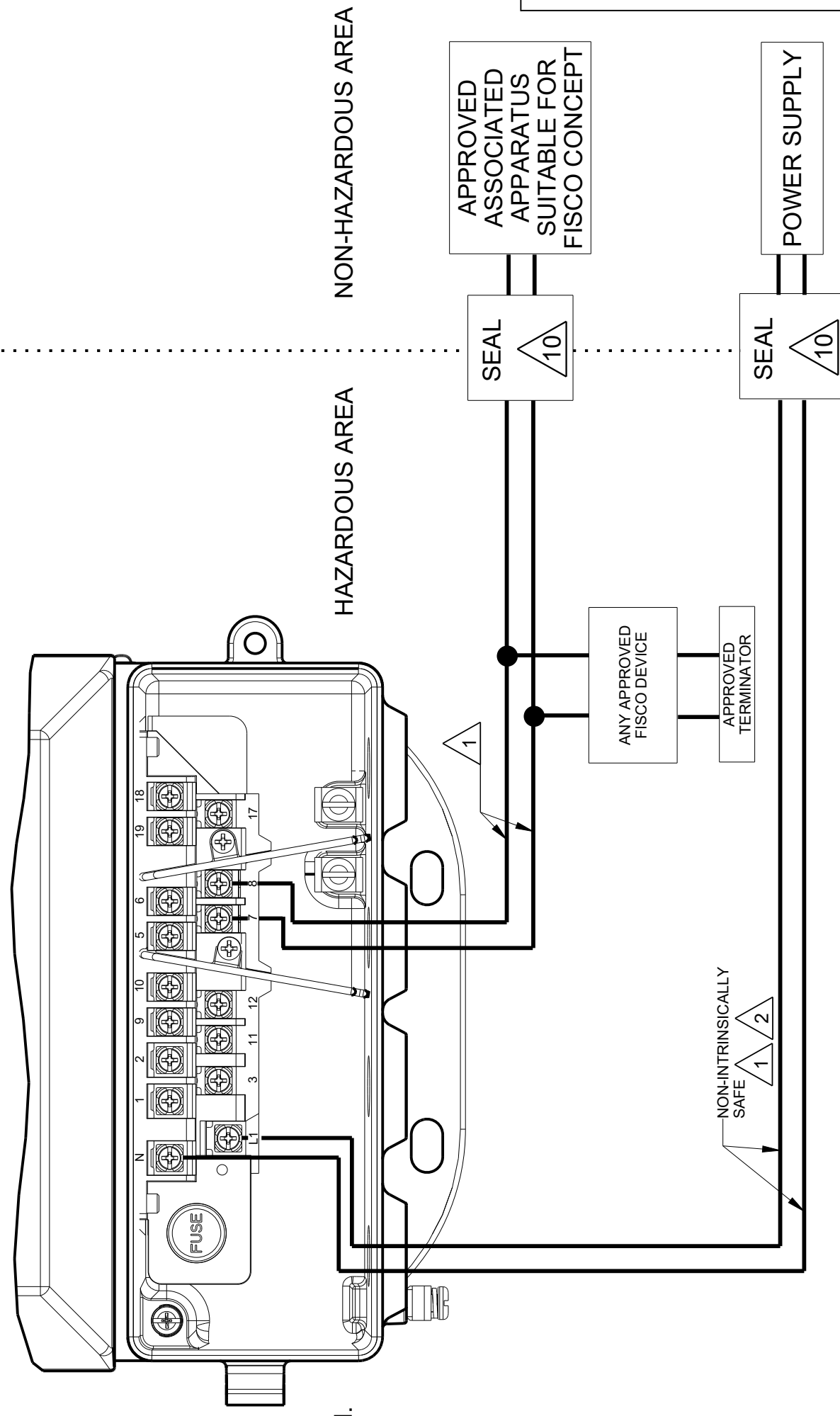
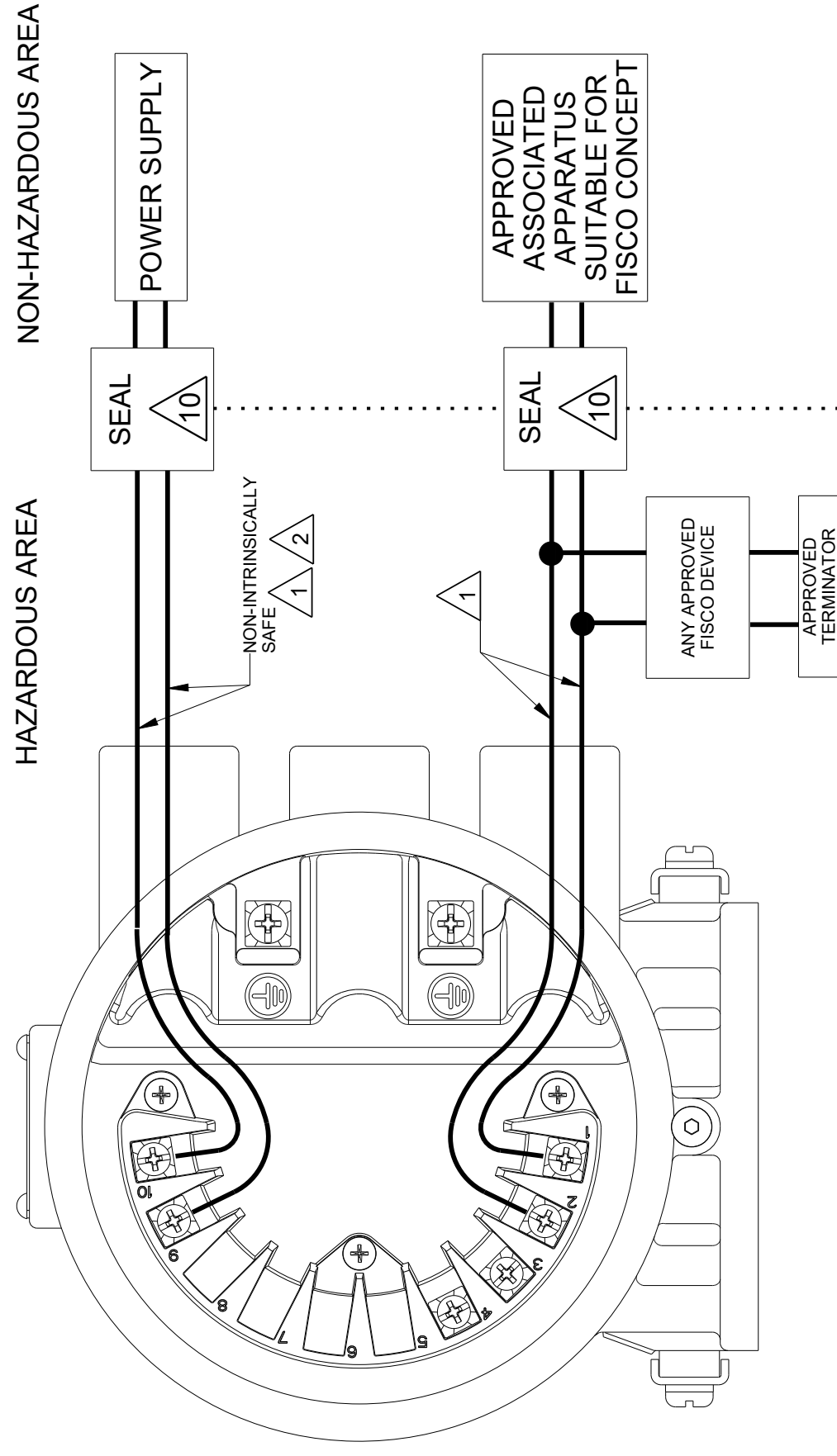

CONFIDENTIAL AND PROPRIETARY INFORMATION IS CONTAINED HEREIN AND MUST BE HANDLED ACCORDINGLY.	SURFACE FINISH UNLESS OTHERWISE SPECIFIED	125	3RD ANGLE	SIZE	C	SCALE	-	REV	AE
	UNLESS OTHERWISE SPECIFIED DIMENSIONS IN INCHES (mm). REMOVE ALL BURRS AND SHARP EDGES.	-DEC TOLERANCES- X ± .1 [2.5] .XX ± .02 [0.5] .XXX ± .010 [0.25] FRACTIONS ± 1/32 ANGLES ± 2'							
<b>EMERSON</b>									
ROSEMOUNT									
TITLE INSTALLATION DRAWING 8750W, ATEX & IECEX HAZARDOUS LOCATIONS									
DR.	J. LAGE	9/16/15	DRAWING NO.	8750W-2052					
APPD.	M. MAYER	9/16/15	DOC TYPE	SHEET 11 OF 11					



00825-MA00-0004, Rev. AB  
May 2019

#### **Emerson Automation Solutions USA**

7070 Winchester Circle  
Boulder, Colorado USA 80301  
T +1 303-527-5200  
T +1 800-522-6277  
F +1 303-530-8459  
[www.emerson.com](http://www.emerson.com)

#### **Emerson Automation Solutions Asia**

1 Pandan Crescent  
Singapore 128461  
Republic of Singapore  
T +65 6363-7766  
F +65 6770-8003

#### **Emerson Automation Solutions Europe**

Neonstraat 1  
6718 WX Ede  
The Netherlands  
T +31 (0) 70 413 6666  
F +31 (0) 318 495 556  
[www.micromotion.nl](http://www.micromotion.nl)

#### **Emerson Automation Solutions United Kingdom**

Emerson Process Management Limited  
Horsfield Way  
Bredbury Industrial Estate  
Stockport SK6 2SU U.K.  
T +44 0870 240 1978  
F +44 0800 966 181

©2019 Rosemount, Inc. All rights reserved.

The Emerson logo is a trademark and service mark of Emerson Electric Co. Rosemount, 8600, 8700, 8800 marks are marks of one of the Emerson Automation Solutions family of companies. All other marks are property of their respective owners.

**ROSEMOUNT™**

  
**EMERSON®**