

TRIAC
2R Series Actuators:

Attention: Instructional videos on some of the information provided below can be found on our website www.atcontrols.com (<http://www.a-tcontrols.com/videos/>).

Description	Section
Installation of Actuator	1
Air Supply	2
Lubrication	3
Travel Adjustment	4
Spare Parts	5
Operation – Double Acting	6
Operation – Spring Return FCW	7
Disassembly Procedures	8
Assembly Instructions	9
Actuator Testing	10
Cycling of infrequently used actuator	11
Bill of Materials	12
Service	13

1. Installation of Actuator:

Triac actuators are mounted directly to valves or adapted to the valve by means of an intermediate bracket and coupler. The coupler adapts the output of the actuator to the valve shaft. Standard mounting kits provide mounting of the actuator in the direction of the pipe. Pipelines can be horizontal, vertical, or other positions. When mounting the actuator to a valve using a mounting kit, the pinion drive, coupling device and valve stem should be centered and concentric to prevent any side loading to the bottom pinion radial bearing and valve stem seal area. After mounting, it may be necessary to adjust the end of travel stop for proper open or closed valve position. Pneumatically stroke the actuator several times to assure proper operation with no binding of the coupler.

2. Air Supply:

Pneumatic piping to the actuator and associated accessories should follow the best practices for instrument pneumatic piping systems, ie line free of water, oil, pipe sealant or other contaminants. The operating medium is to be filtered dry air or inert gas which is filtered to 50 micron particles size or less. It is extremely important that the actuator be powered with the proper air pressure and air volume. Maximum working pressure is 150 PSI.

The spring housing on spring return actuators, if not piped, will breathe through the right hand port. It's important that it not be exposed to a corrosive atmosphere. Please contact Triac Controls for possible solutions if this condition exists.

3. Lubrication:

Triac actuators are factory lubricated for life and additional lubrication is not normally required. However, for actuators performing 100,000 cycles or more, an oil mist lubricator is recommended. Oil mist lubrication requires a mineral oil type ISO VG32 Class 1 for usage in temperature range 15 to 158 Deg. F. Oil mist lubricator must be set to the lowest setting. Once begun, the oil mist lubrication cannot be discontinued. Caution: If the actuator is equipped with a pneumatic positioner or pneumatic controller, oil mist lubricated air cannot be used unless the instrument manufacturer indicates that the instrument is compatible with lubricated air.

4. Travel Adjustment:

The Triac 2nd generation rack & pinion actuators have travel stop adjustments in both the clockwise and counterclockwise directions. The 5 degrees overtravel feature provides adjustments from -5 degrees to +5 degrees at the 0 degree clockwise position and from 85 degrees to 95 degrees at the 90 degree counterclockwise position.

All actuated valves require accurate travel-stop adjustments at both ends of the stroke to obtain optimum performance and valve seat life. The accumulation of tolerances in the adaption of actuators to valves is such that there must be a range of adjustment for both ends of the stroke to achieve the expected performance. See the valve manufacture's IOM on how the travel should be adjusted.

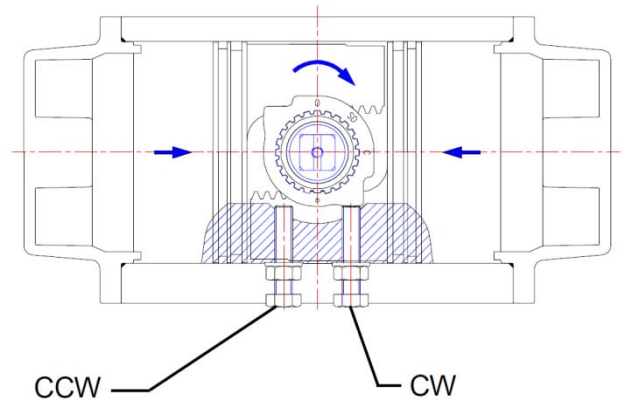

Fig. 1

- **Ball & Plug Valves** require precise adjustment at the open and closed position. This is to protect the seat from the flow media and to assure absolute shut-off in the closed position.
- **Butterfly Valves** require precise adjustment at the open and closed position. This is to assure full shut-off, to prevent disc overtravel which can damage the seat in the closed position, and to assure maximum flow in the open position.
- **Tee Assemblies**, where two valves are operated in tandem through a single operator, (3-way configuration) require precise adjustment at both ends of the stroke. This is to assure the seating of both valves.

5. Spare Parts:

Actuator Size	Buna Repair Kit -20°F to 175°F	Viton Repair Kit 0°F to 300°F	Low Temp Repair Kit -45°F to 175°F	Spring Cartridges (each)
2R40	2RKB0040	2RKV0040	2RKLT0040	SP20040
2R80	2RKB0080	2RKV0080	2RKLT0080	SP20080
2R130	2RKB0130	2RKV0130	2RKLT0130	SP20130
2R200	2RKB0200	2RKV0200	2RKLT0200	SP20200
2R300	2RKB0300	2RKV0300	2RKLT0300	SP20300
2R500	2RKB0500	2RKV0500	2RKLT0500	SP20500
2R850	2RKB0850	2RKV0850	2RKLT0850	SP20850
2R1200	2RKB1200	2RKV1200	2RKLT1200	SP21200
2R1750	2RKB1750	2RKV1750	2RKLT1750	SP21750

*Seal Kits also available, but Complete Repair Kits are recommended

6. Operation – Double Acting:

CCW:

Air is supplied to Port A forcing the pistons away from each other (toward ends) which rotates the drive pinion counterclockwise and exhausts the air out of Port B.

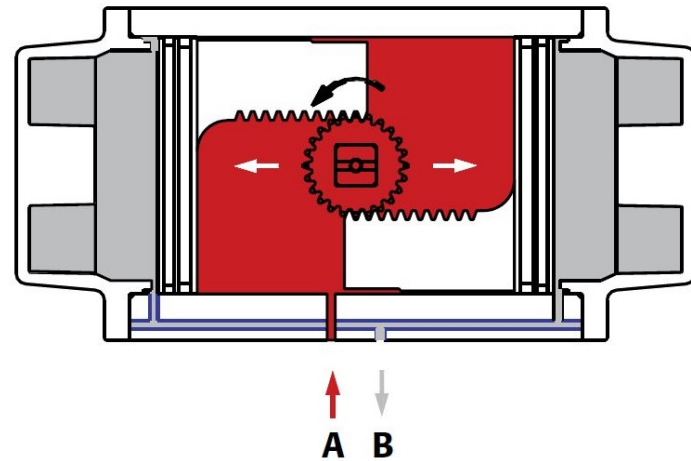

CW:

Air is supplied to Port B forcing the pistons toward each other (toward center) which rotates the drive pinion clockwise and exhausts the air out of Port A.

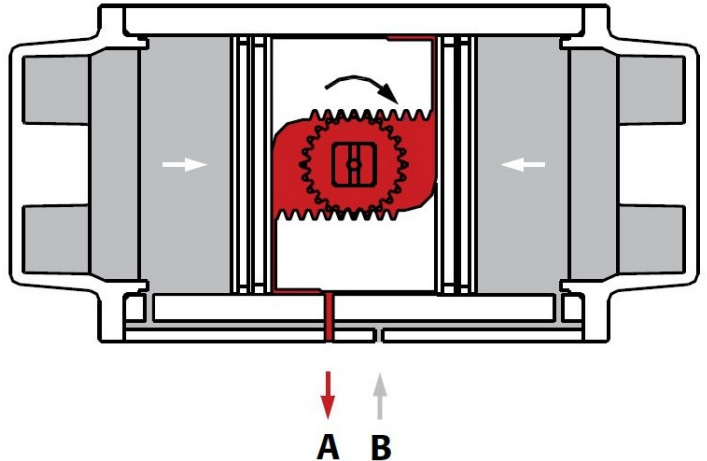

7. Operation – Spring Return (Fail CW):

CCW:

Air is supplied to Port A forcing the pistons away from each other (toward ends), which rotates the drive pinion counterclockwise, compresses the springs and exhausts air out of Port B.

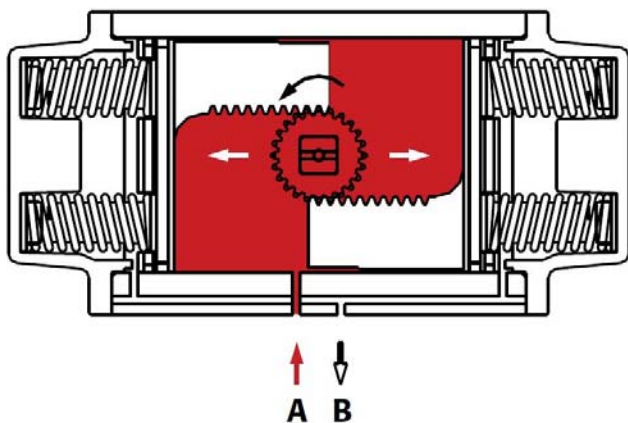

FAIL CW:

Air failure (loss of pressure) allows the compressed springs to force pistons toward each other (toward center), which rotates the drive pinion clockwise and exhausts air out of Port A.

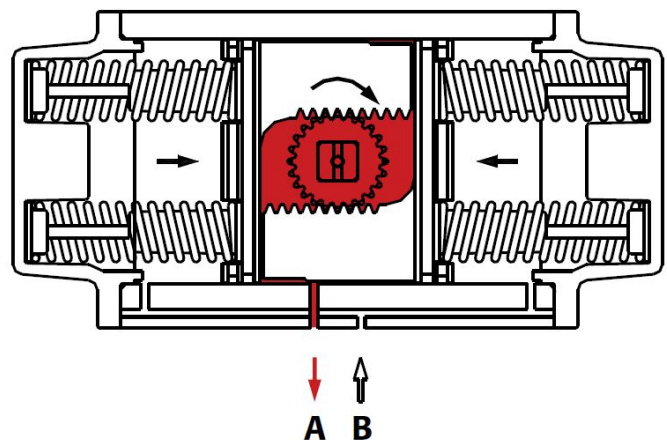

*(Unit is capable of failure in counterclockwise direction by reversing pistons inside of housing.)

8. Disassembly Procedures:

CAUTION

Before removing any components of the actuator, ensure that all pneumatic and electrical power supplies are disconnected.

8.1 Removal of Travel Stops:

Disconnect air supply and electric to de-pressure the actuator. Release the lock nuts and unscrew both travel stops and seals, which are located at the top of the actuator body on the side. In the case of spring return valves make sure that the actuator is in the failed position before removing the actuator

8.2 Removal of End Caps:

Spring Return Units:

Loosen all end cap bolts evenly, to allow the springs to push the end caps out from the body. The springs are contained on spools and the tension will be relaxed when the end cap is removed. Always use caution when removing springs.

Double Acting Units:

Loosen and remove the end cap bolts evenly on both end caps. Using a rubber mallet rotate the end cap slightly, gaining access to the edges of the end cap. Use the rubber mallet to remove the end cap evenly.

8.3 Removal of Pistons:

Rotate the pinion using a wrench to drive the pistons apart until they are free of the actuator body.

8.4 Removal of Pinion:

Remove the snap ring, thrust washer and thrust bearing from the top of the pinion. Carefully remove the pinion from the cylinder body through the bottom. The travel stop cam will not fit through the bottom bore. It will slip off the pinion prior to the pinion removal. Take care to ensure the pinion does not damage the body.

9. Assembly Instructions

9.1 Inspection:

Check that all components are clean and have not been damaged. Triac recommends that all O-rings, Bearings, Washers, etc are replaced using only Triac replacement parts.

9.2 Installing the Pinion:

Lightly grease the pinion, o-ring grooves and guide bushing groove of the pinion and pinion o-rings with multi-purpose grease. Install the top bearing into the actuator body bearing bore. Fit the top o-ring into the top pinion groove. Fit the bottom guide bushing into the bottom pinion groove. Slip the bottom o-ring into the bottom pinion groove. Carefully insert the pinion into the body until the top of the Pinion is inside the body cylinder. Fit the travel stop cam over the top of the pinion and slide it down until it is engaged with the pinion. (Note: The travel stop cam will engage with the pinion in only one position.)

Gently push the pinion up through the body making sure the bottom guide bushing, bottom o-ring & top o-ring stay in their grooves. With the pinion in this position install the thrust bearing washer, the thrust washer and lastly the snap ring. Make sure the snap ring fits properly in the groove.

9.3 Alignment of Pinion for Correct Piston Installation:

Rotate the pinion to the position shown in Fig. 5 (When viewed from the slot at the top of the pinion) ensuring that the machined stop flats are in the correct orientation.

9.4 Installing the Pistons:

Lightly grease the piston o-rings, piston backup ring & guide plate with multi-purpose grease & fit the o-rings, backup ring & guide plate into their respective grooves on the piston. Liberally grease the actuator body bore and the piston rack. Insert the pistons into the bore, one piston in each end with the teeth facing each other (see Figures 2, 3 & 4). (Note: The position of the Piston determines the fail rotation of the actuator).

Push both pistons together until they are both in contact with the pinion, so that when the pinion is rotated (Clockwise for FCW, Counter Clockwise for FCCW) the pistons are drawn together. When the pistons are together and the racks are correctly engaged with the pinion, the top pinion drive flats should be several degrees past perpendicular to the body for FCW, parallel to the body for FCCW.

9.5 Installing the Travel Stops:

With the pistons together, screw in the corresponding travel stop assembly complete with nut, washer and seal until it comes into contact with the pinion. Rotate the pinion 90 degrees to drive the pistons apart and screw in the other travel stop until it comes into contact with the pinion. After the end caps are installed (see below) final adjustment is easily made when the actuator has been mounted to its valve, damper or other device, depending on individual requirements. Ensure the nuts are tightened against washer and seal.

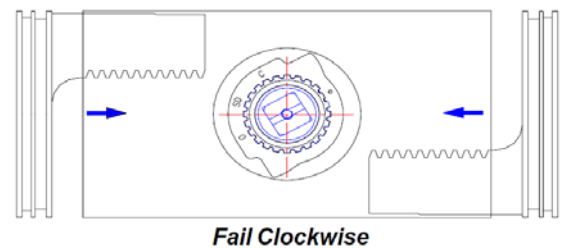
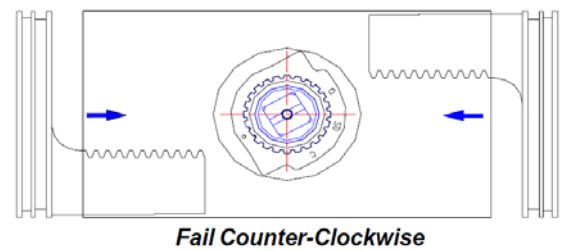

Fig. 5

9.6 End Cap Installation:

With the pistons together, lightly grease the end cap o-rings with multi-purpose grease. Grease the ends of the body bore and the end caps. Install the o-rings into the groove in the end caps.

Spring Return Unit

Install the correct number of springs for the desired torque output. Place the springs into the pockets of the piston and end cap. Balance the springs across the Pistons.

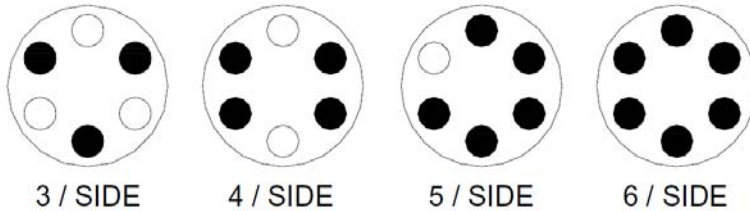
**10. Testing:**

Using compressed air at 80psi-100psi, check the seal areas with soapy water and ensure no bubbles are produced and that the pinion rotates smoothly over its full travel.

11. Cycling of infrequently used or stored actuators:

Actuators that are not in current use for at least a 3 month period, should be cycled a minimum of ten times. The seal manufacturers recommend this procedure to prevent pre-set of the seals.

12. Bill of Materials:

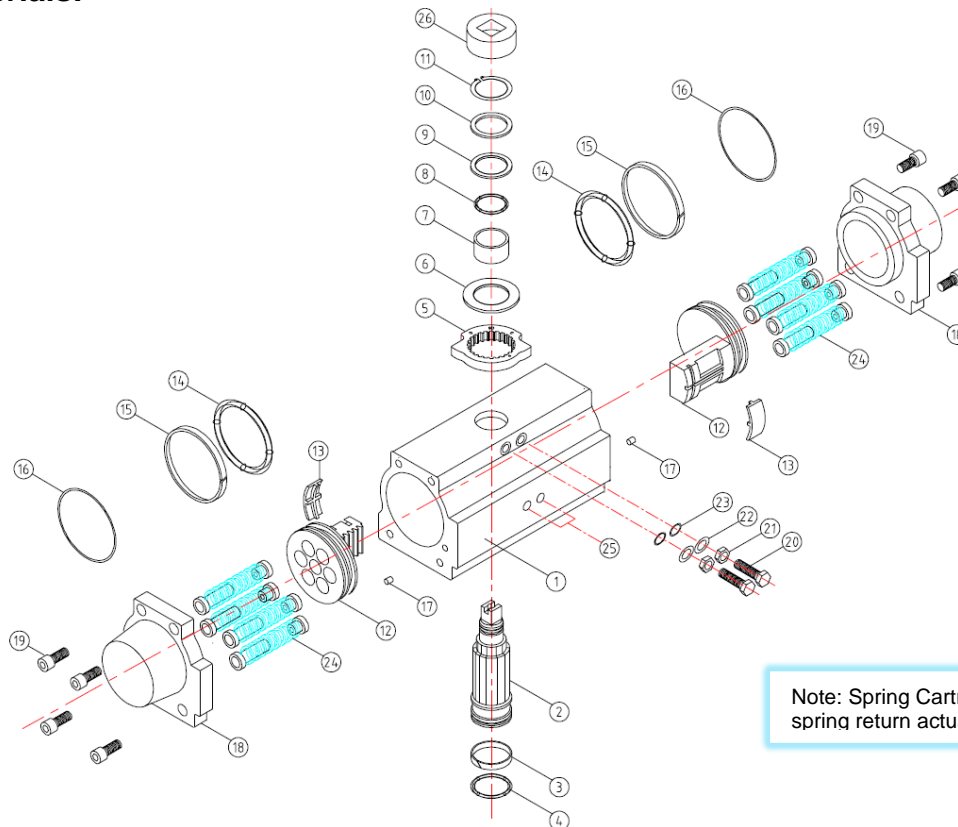

Note: Spring Cartridges are for spring return actuator only

	Description	Qty	Material	Remarks
1	Cylinder Body	1	Aluminum	Hard Anodized
2	Drive shaft/Pinion	1	Steel	Electroless Nickel Plated
3	Bottom Pinion Bushing***	1	Nylon	
4	Bottom Pinion O-Ring***	1	Nitrile Buna	
5	Travel Stop Cam	1	SCM21	Phosphate Coated
6	Travel Stop Washer	1	PTFE	
7	Top Pinion Bushing***	1	Nylon	
8	Top Pinion O-Ring***#	1	Nitrile Buna	
9	Pinion Teflon Washer***	1	RTFE	
10	Pinion SST Washer***	1	304 SST	
11	Snap Ring***	1	Steel	Electroless Nickel Plated
12	Piston	2	Die Cast Aluminum	Dichromate Dipped
13	Guide Plate***	2	Nylon	
14	Piston O-Ring***#	2	Nitrile Buna	
15	Piston Guide Band***	2	PTFE	
16	End Cap O-Ring***#	2	Nitrile Buna	
17	Hole Sealant	2	Nitrile Buna	
18	End Cap	2	Die Cast Aluminum	Epoxy Coated
19	End Cap Bolts	8	304 SST	
20	Travel Stop Bolt	2	304 SST	
21	Travel Stop Nut	2	304 SST	
22	Travel Stop Washer	2	304 SST	
23	Travel Stop O-Ring***#	2	Nitrile Buna	
24	Spring Cartridge	Varies	Spring Steel	Epoxy Coated
25	Dust Plug	2	Polyethylene	
26	Position Indicator	1	Polyethylene	

*** Parts included in Repair Kit (Recommended)

Parts included in Seal Kit

13. Service:

It is the policy of Triac to give the best possible service to our customers. We are happy to assist you in any way we can. If you have any questions about Triac Actuators or other Triac products please contact A-T Controls or your local Triac Distributor.

A-T Controls, Inc. • 9955 International Boulevard, Cincinnati, OH 45246 • Phone: (513) 530-5175 • Fax: (513) 247-5462 • www.a-tcontrols.com

A-T Controls product, when properly selected, is designed to perform its intended function safely during its useful life. However, the purchaser or user of A-T Controls products should be aware that A-T Controls products might be used in numerous applications under a wide variety of industrial service conditions. Although A-T Controls can provide general guidelines, it cannot provide specific data and warnings for all possible applications. The purchaser / user must therefore assume the ultimate responsibility for the proper sizing and selection, installation, operation, and maintenance of A-T Controls products. The user should read and understand the installation operation maintenance (IOM) instructions included with the product, and train its employees and contractors in the safe use of A-T Controls products in connection with the specific application.

While the information and specifications contained in this literature are believed to be accurate, they are supplied for informative purposes only. Because A-T Controls is continually improving and upgrading its product design, the specifications, dimensions and information contained in this literature are subject to change without notice. Should any question arise concerning these specifications, the purchaser/user should contact A-T Controls.

For product specifications go to <http://download.a-tcontrols.com/>