

# NUMATICS®

## PBS Series

Power Block Slide



[www.numatics.com](http://www.numatics.com)

## PBS Series

Features and Benefits	3
How To Order	4
Technical Specifications	4
Dimensions	5
Quick Disconnect Cables	6
Switch Information	6-7

### PBS-Series Power Block Slides

**Designed for applications where space is at a minimum.**

The PBS-Series has an internally built-in air cylinder in the carriage assembly, reducing overall length. The carriage assembly is supported by four recirculating linear ball bearings and two hardened guide shafts.

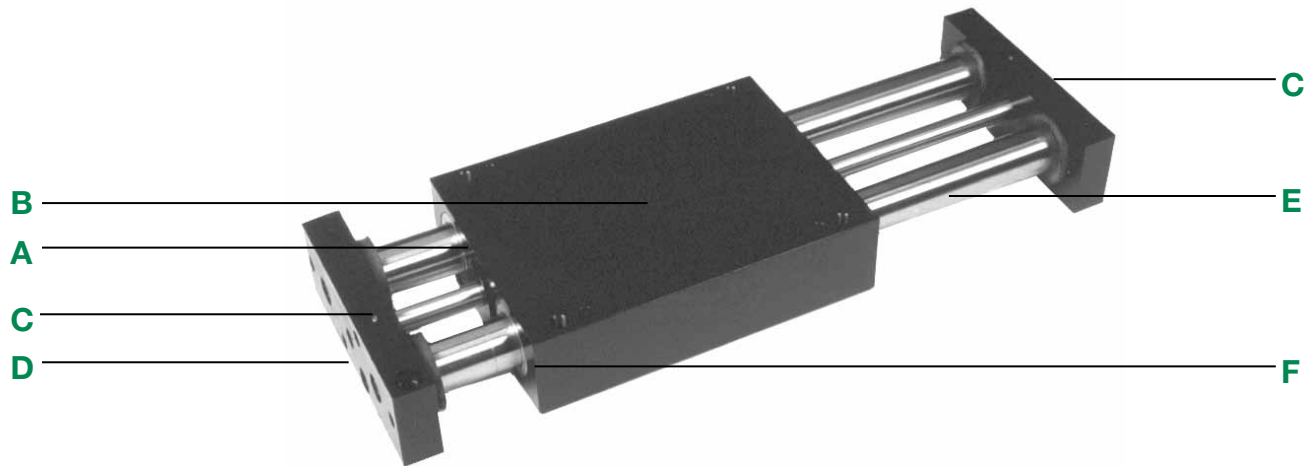

**A. Carriage:**

Four recirculating linear ball bearings. Easy access mounting and dowel location holes.

**B. Air Cylinder:**

Internally housed in carriage. Low friction U-cup lip seals for long service life.

**C. Tool Bars:**

Standard dowel locating holes and accurately milled locating slots. Machined to accept industry standard shock absorbers, and position proximity switch sensors.

**D. Stroke Adjusting Screw:**

Easy access stroke adjusting screws for exact carriage stroke. Adjustable in both directions.

**E. Guide Shafts:**

Hardened Steel to RC 60-65

**F. Bearings: (Two Choices)**

Four linear ball bearings...greatest load capacity, factory lubricated, built-in wipers, self-aligning.  
Four PTFE ball bearings...self-lubricating, self-aligning, long service life, ideal for cleanroom.

**How to Order**

**PBS 075 03 LB 1 4 C 4**

**Bore Sizes**

- 075 = 3/4 Inch
- 100 = 1 Inch
- 125 = 1-1/4 Inches

**Standard Stroke**

- 01 = 1"
  - 02 = 2"
  - 03 = 3"
  - 04 = 4"
  - 05 = 5"
  - 06 = 6"
- NOTE: Max. stroke  
PBS075-4.0  
PBS100-5.0  
PBS125-6.0

**Bearing Option**

- LB = Linear Ball
- TB = PTFE Bearing

**Seal Option**

- 1 = Buna-N Seals
- 2 = FKM Seals

**Shock Absorbers**

- 1 = Extend
- 2 = Retract
- 3 = Extend and Retract
- 4 = No Shocks

**Sensing Position**

- A = Single Position Extend
- B = Single Position Retract
- C = Two Position Sensing
- D = No Sensing

**Sensing Type**

- Standard Cord Set
  - 4 = Prox Switch - PNP (sourcing)
  - 5 = Prox Switch - NPN (sinking)
  - 6 = No Sensing
  - Quick Disconnect Cord Set
  - W = Prox Switch - PNP (sourcing) Straight
  - V = Prox Switch - NPN (sinking) Straight
  - U = Prox Switch - PNP (sourcing) 90 Deg.
  - T = Prox Switch - NPN (sinking) 90 Deg.
- Prox switches are 8 mm diameter.

**When ordering additional switches:**

Switch Description	Standard Part No.	Quick Disconnect Part No.
Prox Switch - PNP (Sourcing)	PROX-8FL2-PN	PROX-8QDS-PN
Prox Switch - NPN (Sinking)	PROX-8FL2-PN	PROX-8QDS-PN
Quick Disconnect Cable	-	PXCST
90° 5 meter cable	-	PXC90

**Technical Specifications**

	PBS075	PBS100	PBS125
Max. Air Pressure	120 psi	120 psi	120 psi
Thrust force @ 100 psi	31 lbs	62 lbs	100 lbs
Maximum Stroke	4.00	5.00	6.00
Cylinder Bore Dia.	0.75	1.00	1.25
F1 Load	90 lbs	275 lbs	520 lbs
F2 Load	90 lbs	275 lbs	520 lbs
Deflection @ max Load & Stk	0.003	0.003	0.003
M2 Moment	120 in.-lbs.	275 in.-lbs.	450 in.-lbs.
M3 Moment	200 in.-lbs.	750 in.-lbs.	1590 in.-lbs.
M4 Moment	200 in.-lbs.	750 in.-lbs.	1590 in.-lbs.

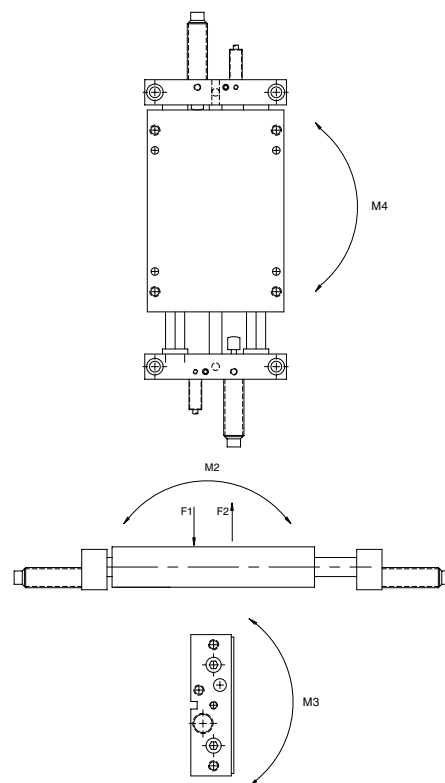

## Dimensions: Inches

### PBS-Series Power Block Slide Dimensions

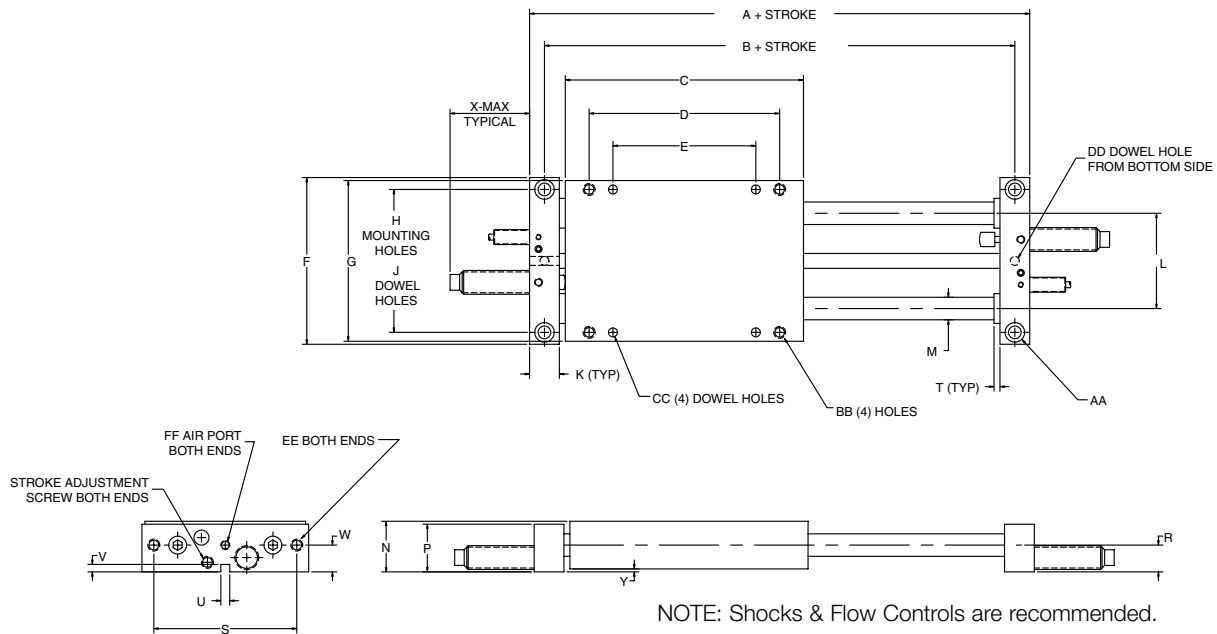

	PBS075	PBS100	PBS125
A	6.500	8.000	9.000
B	5.875	7.250	8.250
C	5.000	6.000	7.000
D	4.000	5.000	5.750
E	3.000	4.000	4.750
F	3.500	4.500	5.000
G	3.375	4.375	4.870
H	3.000	3.875	4.375
J	2.999/3.001	3.874/3.876	4.374/4.376
K	0.625	0.750	0.750
L	2.000	2.440	2.730
M	.472	0.788	0.985
N	1.060	1.313	1.813
P	1.000	1.250	1.750
R	0.563	0.687	0.938
S	3.000	3.875	4.375
T	0.125	0.250	0.250
U	0.1877/0.1892	0.1877/0.1892	0.1877/0.1892
V	0.156	0.156	0.156
W	0.563	0.688	0.938
X	2.200	2.200	2.200
Y	0.063	0.063	0.063
AA	CLEARANCE FOR 1/4 SHCS	CLEARANCE FOR 5/16 SHCS	CLEARANCE FOR 5/16 SHCS
BB	1/4-20 X 0.50 DEEP	5/16-18 X 0.63 DEEP	5/16-18 X 0.63 DEEP
CC	0.1892/0.1877 THRU	0.2505/0.2510 THRU	0.2505/0.2510 THRU
DD	0.1877/0.1892 X 0.25 DEEP	0.1877/0.1892 X 0.25 DEEP	0.1877/0.1892 X 0.25 DEEP
EE	1/4-20 THRU	5/16-18 THRU	5/16-18 THRU
FF	#10-32	#10-32	1/8 NPTF

**PBS Series Switch Information**

**PBS Series Gantry**

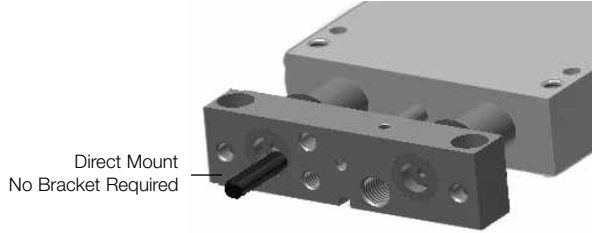

Sensor Description	Standard Cord Set	Quick Disconnect
Prox PNP	PROX-8FL2-PN	PROX-8QDS-PN
Prox NPN	PROX-8FL2-PN	PROX-8QDS-PN

**Quick Disconnect Cables**

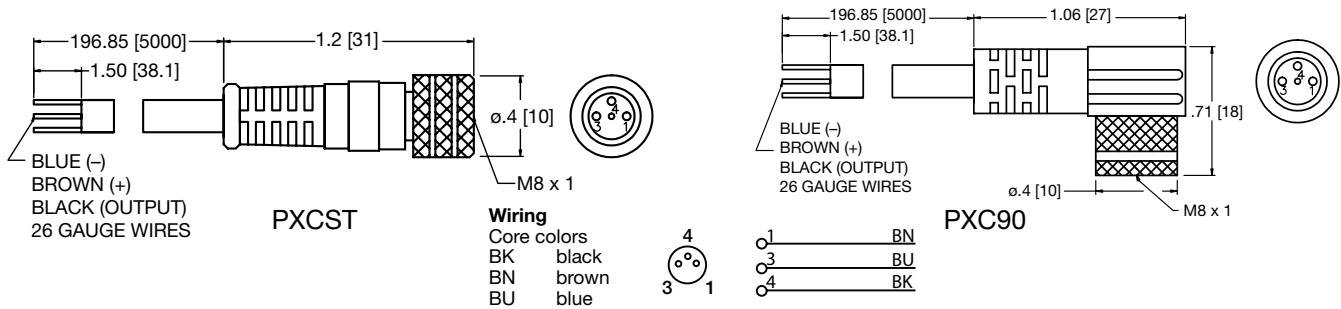

Order Code	Type	Operating Voltage	Current Rating	Cable Material	Protection	Connector
PXCST	Straight 5 m Cable (3 x 26 Gauge wire)	60 AC/75 DC	3 A	PUR	IP 68, III	M8
PXC90	90° 5 m Cable (3 x 26 Gauge wire)	60 AC/75 DC	3 A	PUR	IP 68, III	M8

**Prox Switch (PNP & NPN NO) Flying Leads - PROX-8FL2-PN**

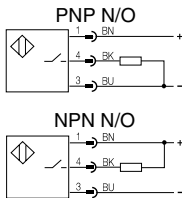
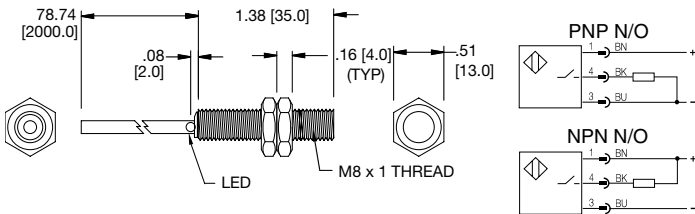

Electrical Design	3-Wire DC PNP; 2-Wire DC PNP/NPN
Output	Normally Open
Operating Voltage	10-30 VDC
Current Rating	100 mA
Minimum Load Current	2 mA*
Leakage Current	< .5 mA
Short Circuit Protection	Yes (Non-Latching)
Overload Protection	Yes
Reverse Polarity Protection	Yes
Voltage Drop	< 2.8V
Current Consumption	< 10 mA**
Switching Frequency	> 1000 Hz
Ambient Temperature	0°C to 70°C
Protection	IP 67, III
Hysteresis	1 - 15% OF Sr
Operating Distance	0 - 2.4mm
Correction Factor	Mild Steel=.1, Stainless Steel=.7, Brass=.5, Alum.=.4, Copper=.3
Housing Material	Brass with Bronze Coated
Function Display Switching Status	Yellow LED
Connection	PVC Cable, 2m, 3 x .14mm <sup>2</sup>
Remarks	*Only in 2-Wire Operation **Only in 3-Wire Operation

\*Switches are not designed for wet environments. Please see your distributor for additional information.

### Prox Switch (PNP & NPN NO) 8 mm connector - PROX-8QDS-PN

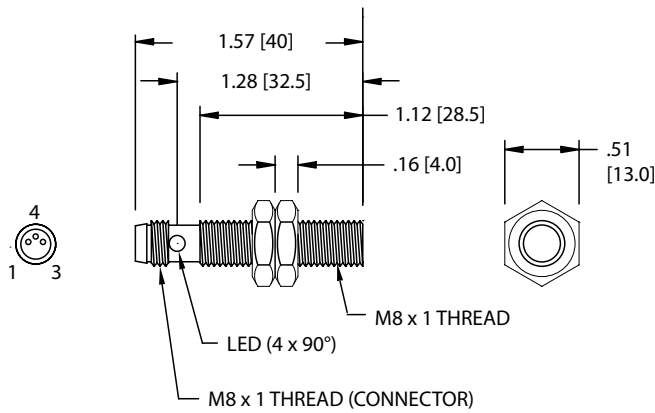

#### Electrical Design

Output  
 Operating Voltage  
 Current Rating  
 Minimum Load Current  
 Leakage Current  
 Short Circuit Protection  
 Overload Protection  
 Reverse Polarity Protection  
 Voltage Drop  
 Current Consumption  
 Switching Frequency  
 Ambient Temperature  
 Protection  
 Hysteresis  
 Operating Distance  
 Correction Factor

#### Housing Material

Function Display Switching Status  
 Connection  
 Remarks

Accessories  
 Agency Approvals



3-Wire DC PNP;  
 2-Wire DC PNP/NPN  
 Normally Open  
 10-30 VDC  
 100 mA  
 2 mA\*  
 < .5 mA  
 Yes (Non-Latching)  
 Yes  
 Yes  
 < 2.8V  
 < 10 mA\*\*  
 > 1000 Hz  
 0°C to 60°C  
 IP 67, III  
 1 - 15% OF Sr  
 0 - 2.4mm  
 Mild Steel=1, Stainless Steel=.7,  
 Brass=.5, Alum.=.4, Copper=.3  
 Brass with Bronze Coated;  
 Active Face: LCP  
 Yellow LED (4 x 90°)  
 M8 Connector  
 \*Only in 2-Wire Operation  
 \*\*Only in 3-Wire Operation  
 2 M8 Lock Nuts Included

\*Switches are not designed for wet environments. Please see your distributor for additional information.

# NUMATICS®

World Class Supplier of Pneumatic Components



## World Headquarters

### USA Numatics, Incorporated

46280 Dylan Drive  
Novi, Michigan 48377

P: 248-596-3200  
F: 248-596-3201

### Canada Numatics, Ltd

P: 519-758-2700  
F: 519-758-5540

### México - Ascomatica SA de CV

P: 52 55 58 09 56 40 (DF y Area metropolitana)  
P: 01 800 000 ASCO (2726) (Interior de la República)  
F: 52 55 58 09 56 60

### Brazil Ascoval Ind.e Comercio Ltda

P: (55) 11-4208-1700  
F: (55) 11-4195-3970