

SERIES 51600

Hinged Emergency Pressure Manhole Cover Vent

SERIES 51600

- Vents directly to atmosphere
- Sizes 16" (DN 400) through 24" (DN 600)
- Pressure setting achieved by weight loading
- Hinged/counterweight design allows for higher settings
- Easy removal of cover allows for tank access
- Patented, FEP film "Air-Cushioned Seating"
- Low-leak pallet design - certified test reports
- Conforms to the latest ATEX Directive
- Easy access manway facilitates inspection & repairs
- Available in Carbon Steel, Aluminum & Stainless Steel



OBJECTIVE

Protectoseal Series 51600 Hinged Emergency Pressure Manhole Cover Vent provides emergency pressure relief for storage tanks that are exposed to an external fire. They are designed for installation on the manhole openings of tanks and provide a means of relieving large volumes of vapors, beyond the capacity of a normal operating vent. The Series 51600 design allows for higher pressure relief settings than are available on our Series 53300 Emergency Pressure Manhole Cover Vent. Series 51600 Manhole Cover Vents do not provide vacuum relief. Vacuum relief must be supplied by the operating vent with which the tank is equipped. See Protectoseal Series 830, 8540, 6240, 16240 and 18540. Series 52500 Manway Cover Vents include pressure and vacuum relief.

TECHNIQUE

When positioned on the flanged seat, the Series 51600 Hinged Emergency Pressure Manhole Cover Vent provides an effective vapor-tight seal. Under emergency fire conditions, the cover can pivot open on its hinge and provide required relief, preventing damage to the tank due to excessive internal pressure. When tank pressure is reduced, the cover automatically recloses. The hinged design allows the use of a lever principle counterweight so that pressure settings higher than those available on our Series 53300 Emergency Pressure Manhole Cover Vent may be achieved. The design allows convenient access through the manhole opening for tank inspection and maintenance.

SPECIAL FEATURES

Fast Inspection, Easy Maintenance. Design and light weight of unit permit easy, convenient handling for inspection and maintenance. Opening of hinged cover allows access into tank through the seat area.

Higher Pressure Settings. The hinged design and lever arm loading capabilities of the Series 51600 allows for higher pressure settings than are available on other dead weight loaded vents of similar size. Full open flow capacity and automatic reclosing of the vent as tank pressure decreases provide

efficient and dependable emergency venting capability while minimizing amount of vapor unnecessarily vented to the atmosphere.

Maintains Accurate Pressure Settings. Set points are accurate to within +/- 3% across the entire range of available pressure relief settings shown in the chart on the reverse. Set point accuracy is assured by stringent machining, assembly and test procedures.

Air-Cushioned Seating. A flat, smooth diaphragm of FEP film is supported on both sides of an annular channel to form a floating air seal with the seat. An outer support rim assures proper seating.

Low-Leak Covers. Leakage on vent covers is no more than 1 SCFH at 90% of the set pressure.

Sizes Available. Available in 16" (DN 400) through 24" (DN 600) sizes. Flanged to mate with standard flanged 150# ANSI, API (20" or 24" only) or DIN PN 16 bolting specifications. Other drilling patterns are also available upon special request.

PRO-FLOW[®] Sizing and Selection Software.

Use PRO-FLOW[®] to select the correct size unit for emergency pressure and vacuum relief calculated in accordance with API 2000, ISO 28300, NFPA 30 and OSHA 1910.106.

CONSTRUCTION

A comprehensive range of materials is offered as shown in the chart below.

Available Options.

- Alternate diaphragm materials
- Material certifications for flange and seat
- FEP coating
- Kynar[®] coating (*Kynar[®] is a Registered Trademark of Arkema, Inc.*)

Series	Base Flange/Seat	Pallet	Diaphragm
AX51600	Steel/316 S.S.	Aluminum	FEP Film
AXCS51600	Steel/316 S.S.	Steel	FEP Film
AXF51600	316 S.S.	316 S.S.	FEP Film

Note: On AX or AXCS Series, weights are steel or lead. On AXF Series, weights are stainless steel or lead.

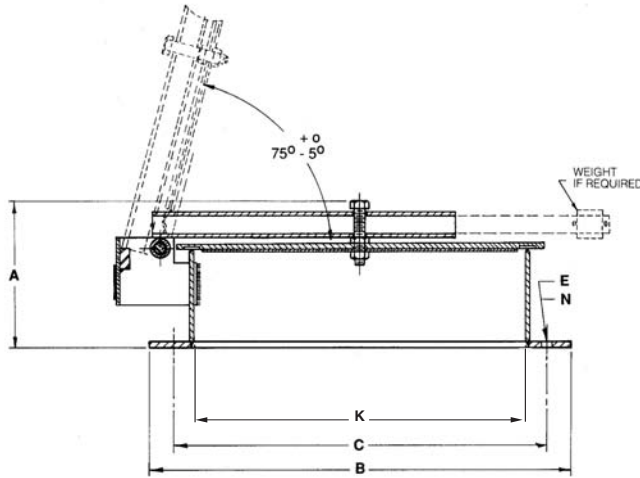

Dimensions shown are for reference only, contact Factory for certified drawings.

DIMENSIONS & ORDERING INFORMATION

Cat. No.	Flange Size	I.D. K	Ht. A	Dia. B	B.C. C	Dia. E	Holes N
51616ASA	16"	15 1/4"	9"	23 1/2"	21 1/4"	1 1/8"	16
51616DN	DN400	410mm	229mm	580mm	525mm	30mm	16
51618ASA	18"	15 1/4"	9"	25"	22 3/4"	1 1/4"	16
51618DN	DN450	462mm	229mm	640mm	585mm	30mm	20
51620ASA	20"	20 1/2"	9"	27 1/2"	25"	1 1/4"	20
51620API	20"	20 1/2"	9"	26"	23 1/2"	3/4"	16
51620DN	DN500	513mm	229mm	715mm	650mm	33mm	20
51624ASA	24"	24"	9"	32"	29 1/2"	1 3/8"	20
51624API	24"	24"	9"	30"	27 1/2"	3/4"	20
51624DN	DN600	616mm	229mm	840mm	770mm	36mm	20

Add Prefix	Base Flange/Seat	Pallet	Diaphragm
AX	Steel/316 S.S.	Aluminum	FEP Film
AXCS	Steel/316 S.S.	Steel	FEP Film
AXF	316 S.S.	316 S.S.	FEP Film

On AX & AXCS Series, weights are steel or lead. On AXF Series, weights are S.S. or lead.

PRESSURE AND/OR VACUUM SETTINGS (Consult factory for settings outside of STANDARD range.)

Series	Flange Size	STANDARD MINIMUM SETTINGS						STANDARD MAXIMUM SETTINGS					
		Pressure			Vacuum			Pressure			Vacuum		
		oz./in. ²	in. W.C.	kPa	oz./in. ²	in. W.C.	kPa	oz./in. ²	in. W.C.	kPa	oz./in. ²	in. W.C.	kPa
AX51616	16"/DN400	1.25	2.16	0.54	N/A	N/A	N/A	20.00	34.60	8.60	N/A	N/A	N/A
AXCS & AXF51616	16"/DN400	2.80	4.84	1.21	N/A	N/A	N/A	20.00	34.60	8.60	N/A	N/A	N/A
AX51618	18"/DN450	1.25	2.16	0.54	N/A	N/A	N/A	20.00	34.60	8.60	N/A	N/A	N/A
AXCS & AXF51618	18"/DN450	2.80	4.84	1.21	N/A	N/A	N/A	20.00	34.60	8.60	N/A	N/A	N/A
AX51620	20"/DN500	1.17	2.02	0.50	N/A	N/A	N/A	16.00	27.70	6.90	N/A	N/A	N/A
AXCS & AXF51620	20"/DN500	2.67	4.62	1.15	N/A	N/A	N/A	16.00	27.70	6.90	N/A	N/A	N/A
AX51624	24"/DN600	1.11	1.92	0.53	N/A	N/A	N/A	12.00	20.77	5.20	N/A	N/A	N/A
AXCS & AXF51624	24"/DN600	2.73	4.72	1.18	N/A	N/A	N/A	12.00	20.77	5.20	N/A	N/A	N/A

ADDITIONAL PRODUCTS FROM PROTECTOSEAL

Series 18540



Pipe-Away Pressure Vacuum Relief Vent for applications that require hazardous vapors be processed into manifolded piping and not released into the atmosphere.

Series 7800



Emergency Vent protects tanks against rupture or explosion resulting from excessive internal pressure caused by exposure to fires.

Series 4950



Vent Line / In-Line Parallel Plate Flame Arrester is designed for installation in open vent pipe or bleed lines from storage or processing tanks. Suitable for NEC Group D (IEC Group IIA) vapors.

Series 830



Combination Pressure / Vacuum Relief Vent & Flame Arrester provides pressure and vacuum relief as well as protection from propagation of externally introduced flames. Suitable for NEC Group D (IEC Group IIA) vapors.