























CYLINDERS & ACTUATORS

Product Index



Products	Type	Illustration	Series	Page	
Panel cylinders	Ø 6 to 16 mm	E		429 1	
Short-stroke cylinders	Ø 8 to 100 mm			441 3	
Round cylinders	Ø 8 to 25 mm - ISO 6432			435 11	
	Ø 32 to 63 mm - ISO 6431			438 15	
Compact cylinders	Ø 20 to 100 mm - ISO 21287			449 20	
	Ø 32 to 100 mm - profiled barrel			453 27	
ISO 15552 cylinders	Food industry cylinders Ø 32 to 100 mm - profiled barrel			454 30	
	Ø 32 to 200 mm - tie-rods			450 34	
	Options and specialised versions: ... Low friction /.../ Tandem / 3 positions / "U" and "H" guiding units / Static rod-locking device / Dynamic rod-locking device / Oversize piston rod / Rod bellow...		   	453 454 450	37 39..59
	Mountings	ISO 21287 - ISO 15552 449/453/454/450 Series			434 439 493 61
Cylinders	Ø 25 to 200 mm - CNOMO/AFNOR	PCN		437 69	
Anti-corrosive cylinders	Ø 12 to 25 mm - ISO 6432			435 11	
	Ø 32 to 80 mm - ISO 6431			431 77	
Rodless cylinders	Ø 32 to 125 mm - ISO 15552	E-F		S 83	
		G-H		445 446 448	
Actuators	Plain or ball bearings guide air cylinder - Ø 16 to 63 mm Twin piston air cylinder with linear guide - Ø 16 to 32 mm	CGT P2L-P2B		CGT 154 447 160-161	
Rotatable cylinders	2, 3 or 4 positions - Ø 12 to 22 mm	R-RS		429 165	
Position detectors	T-slot for T-slot grooves cylinders	ILS MR		494 173 494 175	
	C-slot for series 441 cylinders	MR		494 179	

01430GB-2017/R01
Availability, design and specifications are subject to change without notice. All rights reserved.

All leaflets are available on: www.asco.com

standards	single acting		double acting		model construction								Ø (mm)		standard stroke		 Equipped for position detection ⁽¹⁾	 spare parts kit no.	 ATEX	type	illustration	Series	Page		
	Rod in at rest	Rod out at rest	Non-cushioned	Elastic cushioning	Adjust. pneumatic cushioning	Cylindrical	Food industry	Anti-corrosive	Tie rods	Profiled barrel	Through-rod	Rotation-proof	min.	max.	min.	max.									
Panel cylinders																									
													6	16	5	15							429	1	
Short-stroke cylinders																									
												8	100	4	100								441	3 10	
Round cylinders																									
ISO 6432												12	25	5	400	900							435	11	
													8	25	5	400	900								
ISO 6431												12	25	5	400	900							438	15	
													32	63	5	50	1000								
Compact cylinders according to ISO 21287 standard																									
ISO 21287												ISO 21287											449	VIII 20 23	
													20	100	5	400									
		Mountings											20	100										493	61
Cylinders according to ISO 15552 standard																									
ISO 15552												ISO 15552											453	VII 27 28 30 31 34 35	
												32	100	25	1000										
												32	100	25	1000										
												32	250	25	1000										
		Options and specialised versions:																						453	37 (39..59)
		... Low friction /.../ Tandem / 3 positions / ...																						454	
		... "U" and "H" guiding units / ...																						454	
	... Static rod-locking device / ...																						450		
	... Dynamic rod-locking device / ...																						450		
	... Oversize piston rod / Rod bellow...																						450		
	Mountings												20	100									493	61	

⁽¹⁾ Magnetic position detectors, see page: **V**

standards	single acting		double acting		model construction						Ø (mm)		standard stroke		 Equipped for position detection ⁽¹⁾	 spare parts kit no.	 ATEX	type	illustration	Series	Page	
	Rod in at rest	Rod out at rest	Non-cushioned	Elastic cushioning	Adjust. pneumatic cushioning	Cylindrical	Food industry	Anti-corrosive	Tie rods	Profiled barrel	Through-rod	Rotation-proof	min.	max.								min.
Cylinders according to CNOMO - AFNOR																						
CNOMO AFNOR NF E 49001								∅				25	200	5	2000	∅		-	PCN		437	69 71
Anti-corrosive cylinders																						
ISO 6432						●	●					12	25	5	400 900	●	-	-	-		435	11
ISO 6431						●	●					32	80	25	800 1000	●	-	-	-		431	77
ISO 15552							●	●				32	125	25	500	●			E-F G-H		S	83

⁽¹⁾ Magnetic position detectors, see page: **V**

standards	model										Ø (mm)		standard stroke		 Equipped for position detection (1)	type	illustration	Series	Page		
	double acting			guide			construction				min.	max.	min.	max.							
	Non-cushioned	Elastic cushioning	Adjust. pneumatic cushioning	Without	Ball bearings	Plain bearings	Cross rollers	Round cylinder	Profiled barrel	Rotation-proof	Rodless	Rotatable									
Rodless cylinders																					
	●	●	●		●	●					●		6	80			●	Quick Selection Chart		91	
Rodless cylinders with magnetic couplings																					
				●							●		6	40	50	2000	●	STN		445	95
					●						●		6	40	50	1500	●	STG		445	101
Rodless band cylinders																					
				●							●		16	80	5	6000	●	STBN		448	120
					●						●		25	63	100	3800	●	STB		446	108
					●						●		16	80	5	5500	●	STB		448	125
						●					●		25	50	5	3750	●	STBB		448	135
																	ILS MR	STB-STBN-STBB	Position detectors for cylinder series 448	881	147 149
Actuators with linear guides																					
					●	●		●					16	63	10	100	●	CGT		CGT	154
					●	●		●					16	32	10	160	●	P2L P2B		447	160 161
Rotatable cylinders (90°-180°)																					
											●		12	20	-	-	●	R (2 positions)		429	165
											●		16	22	-	-	●	RS (2, 3 and 4 positions)		429	167

(1) Magnetic position detectors, see page: **V**

model	adaptation on cylinder type					Rotatable cylinders R / RS	illustration	Series	Page
	reed-switch type - 2 wires Magneto-resistive - 3 wires (MIR)	round cylinders	compact profiled barrel	tie-rods	profiled barrel C-slot for series 441 cylinders				
	Series	Series	Series						
	435 438	441 449 453 454	450 437 (PCN)						
Position detectors - for T-slot grooves									
								494	173
					integrated	integrated	mounting kits	494	175
		or			integrated	integrated	mounting kits	494	177
Position detectors - for C-slot grooves									
								494	179

DEFINITION OF THE DIAMETER OF A CYLINDER

• THE DYNAMIC EFFORT DEVELOPED BY A CYLINDER

$$F = \text{Pressure} \times \text{piston area} \times \text{efficiency}$$

The efficiency of a cylinder depends on the diameter of the cylinder, on the pressure and on its mechanical construction. The graph and chart page 6 show the dynamic effort developed by a cylinder at the piston rod, at various supply pressures.

• LOAD FACTOR

This is the relationship expressed as a percentage between the actual load being moved by the cylinder and the dynamic effort available at the end of the piston rod.

$$\text{load factor (\%)} = \frac{\text{actual load}}{\text{dynamic effort}} \times 100$$

For an optimum installation of a cylinder, we recommend a cylinder with a load factor inferior to or equal to 75%.

Example: calculate a cylinder to lift a load of 130 daN with a pressure of 7 bar (gauge pressure).

$$\text{theoretical dynamic effort} = \frac{\text{actual load}}{\text{load factor}} = \frac{130}{0,75} = 175 \text{ daN}$$

The graph below shows the cross over point between the dynamic effort and the supply pressure. The cylinder diameter required will be that where the curve passes this point or the cylinder giving a force immediately above that required.

In the example above: 175 daN is between Ø 50 and Ø 63. The cylinder recommended is the Ø 63 mm which will develop a force of 200 daN at 7 bar and the actual load factor is:

$$\frac{130 \text{ daN}}{200 \text{ daN}} \times 100 = 65 \%$$

EFFORTS DEVELOPED AT THE END OF THE ROD (ROD OUT)

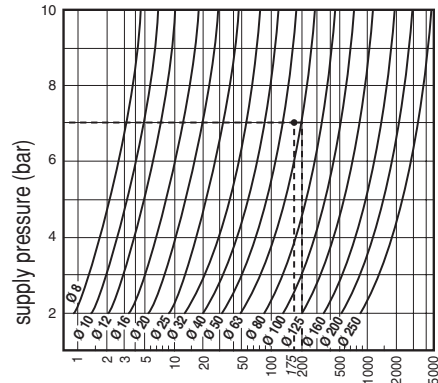

dynamic effort (daN)

EFFORTS DEVELOPED AT THE END OF THE ROD (ROD RETURNED)

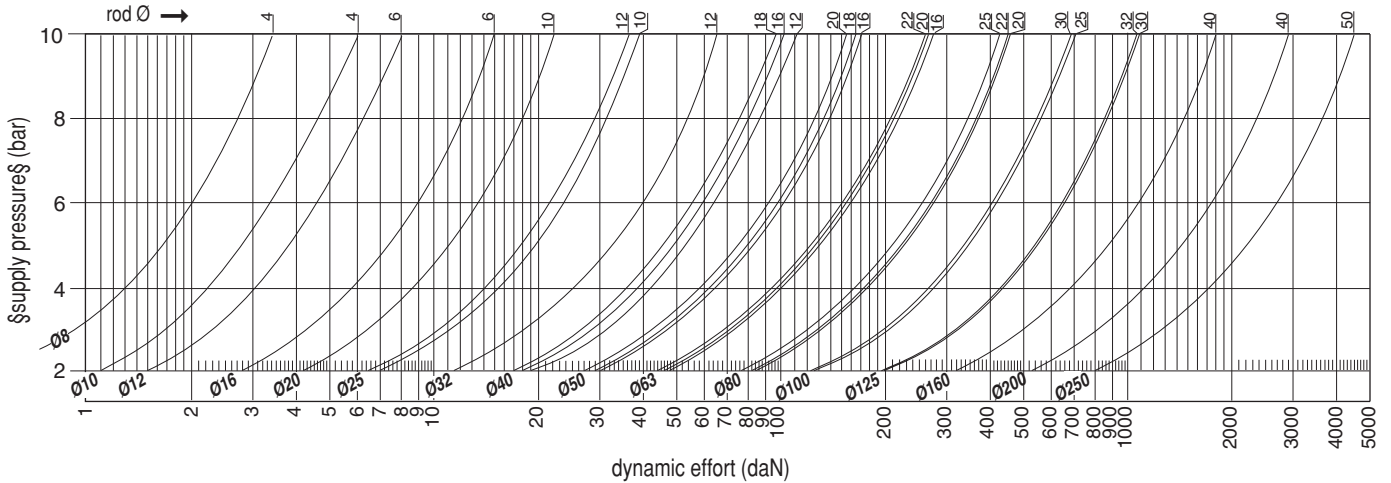

EFFORTS DEVELOPED BY A CYLINDER (daN)

cylinder Ø (mm)	rod Ø (mm)	Series					piston cross-section area (cm ²)		dynamic effort developed (daN) at various supply pressures (bar)									
		435 - 438	435 - 431 (Anti-corrosive)	449	453 - 454 - 453	437 (PCN)			2		4		6		8		10	
		●	○	●	○	●	○	●	○	●	○	●	○	●	○			
8	4	X					0,5	0,4	1,0	0,5	1,5	1,5	2,5	2,0	3,5	2,5	4,5	3,5
10	4	X					0,8	0,6	1,5	1,0	2,5	2,5	4,0	3,5	5,5	4,5	7,5	6,0
12	6	X	X				1,1	0,8	2,0	1,5	4,0	3,0	6,0	4,5	8,5	6,0	10,5	8,0
16	6	X	X				2,0	1,7	3,5	3,0	7,5	6,0	10,0	9,0	15,0	12,0	19,0	15,0
20	10	X	X	X			3,1	2,3	5,5	4,0	12,0	9,0	16,0	13,5	23,0	18,0	30,0	22,0
25	10	X	X	X			4,9	4,1	8,5	7,0	15,0	15,0	24,0	24,0	38,0	31,0	48,0	39,0
32	12	X	X	X	X	X	8,0	6,9	13,0	11,5	30,0	25,0	46,0	40,0	62,0	52,0	77,0	66,0
40	12				X			11,5		19,0		42,0		64,0		87,0		111,5
40	16		X		X		12,6	10,6	21,0	18,0	46,0	39,0	70,0	59,0	95,0	80,0	122,0	102,5
40	18	X				X		10,0		17,0		36,5		56,0		75,5		97,0
50	16			X				17,6		30,0		64,0		100,5		134,0		170,5
50	18	X				X	19,6	17,0	33,0	29,0	70,0	62,0	110,0	97,0	150,0	130,0	190,0	165,0
50	20		X		X			16,5		27,0		58,0		92,0		124,0		155,0
63	16			X				29,1		47,5		101,5		159,5		218,5		273,5
63	20		X		X		31,2	28,1	53,0	46,0	110,0	98,0	170,0	154,0	230,0	211,0	290,0	264,0
63	22	X				X		27,4		44,0		97,0		150,0		200,0		260,0
80	20			X				47,2		82,0		172,5		266,0		365,5		457,0
80	22				X		50,3	46,5	88,0	81,0	185,0	170,0	285,0	262,0	385,0	360,0	480,0	450,0
80	25		X		X			45,4		77,0		163,0		255,0		341,0		427,0
100	25			X	X			73,6		126,5		272,0		412,5		562,5		703,0
100	30				X		78,5	71,5	135,0	123,0	290,0	264,0	440,0	401,0	600,0	546,5	750,0	683,0
125	30					X		115,7		198,0		433,0		658,5		870,0		1082,0
125	32				X		123,0	115,0	210,0	196,5	460,0	430,0	700,0	654,5	925,0	865,0	1150,0	1075,0
160	40				X	X		201,0		350,0		750,0		1150,0		1550,0		1900,0
160	40				X	X		188,0		320,0		700,0		1100,0		1500,0		1800,0
200	40				X	X		314,0		550,0		1150,0		1800,0		2400,0		3000,0
200	40				X	X		302,0		530,0		1100,0		1700,0		2300,0		2900,0

● Efforts developed with rod out (bottom side)

○ Efforts developed with rod returned (rod side)

Note: Cylinders with double crossbar develop identical efforts in both working directions. Their values are the ones defined here-above for efforts developed with rod returned.

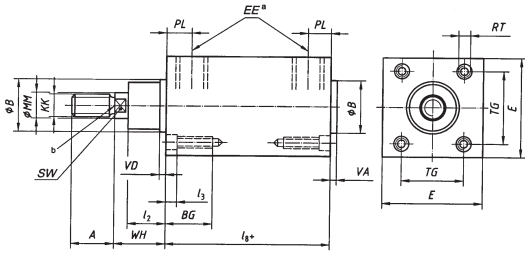
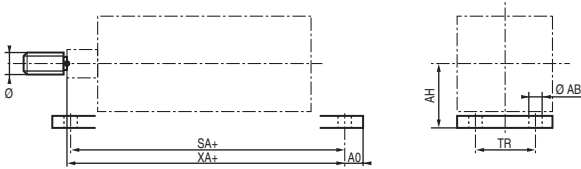
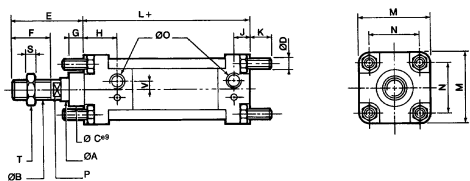
standard of cylinders Ø 32 to 320 mm		INTERCHANGEABILITY	
		within the standard	between standards
<p>ISO 15552 (year: 2004)</p>			
<p>This new international standard cancels and replaces ISO 6431. It defines the outer dimensions of a bare cylinder and equipped with its mountings.</p>  <p>Series 453-454-450: in accordance with the international standards</p>		<p>Full interchangeability between the manufacturers is achieved at every level:</p> <ul style="list-style-type: none"> • bare cylinder • each mounting • complete unit1 	
<p>AFNOR NF ISO 15552 (june 2004) - DIN ISO 15552</p>			
<p>These standards fully include the international standard ISO 15552. The NF ISO 15552 is completed with a definition of the rod diameters MM and cancels and replaces standard NFE 49003 parts 1 to 3.</p> <p>Series 453-454-450: in accordance with the international standards</p>		<p>For full interchangeability with ISO 15552, ISO 6431 cylinder must be equipped with its mountings, and reciprocally.</p>	
<p>ISO 6431 cylinders (year: 1983)</p>			
<p>This international standard defined a cylinder unit equipped with its mountings without specifying the bare cylinder alone. It is cancelled and replaced by above standard ISO 15552.</p>  <p>Series 453-454-450: in accordance with the international standards</p>		<p>Interchangeability between manufacturers is achieved by replacing both the cylinder and its mountings.</p>	
<p>AFNOR NFE 49003 - VDMA 24562 cylinders (year: 1992)</p>			
<p>These standards first define the outer dimensions of a bare cylinder and then its mountings; the cylinder with its mountings installed then corresponds to a cylinder unit according to above standard ISO 6431</p>		<p>Full interchangeability between the manufacturers is achieved at every level:</p> <ul style="list-style-type: none"> • bare cylinder • each mounting • complete unit1 	
<p>CNOMO 06.07.02/AFNOR NFE 49001 cylinders (year: 1968)</p>			
<p>The French standards define first all the external dimensions of a bare cylinder then the mountings.</p>  <p>Series 437 (PCN): complies with the French standards.</p>		<p>No interchangeability can be achieved between CNOMO/NFE 49001 cylinder (bare or equipped) and AFNOR NFE 49003 cylinder or ISO 6431 cylinder, and reciprocally.</p>	

01430GB-2017/R01 Availability, design and specifications are subject to change without notice. All rights reserved.

Note: ISO 6432 and AFNOR NFE 49030 standards apply only to mini-cylinders Ø 8 to 25 mm.

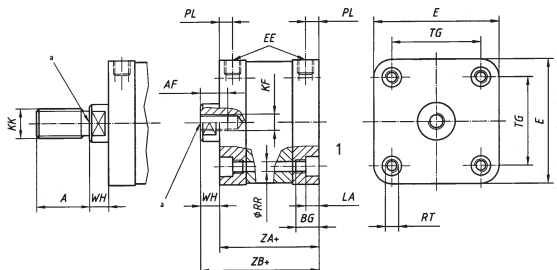
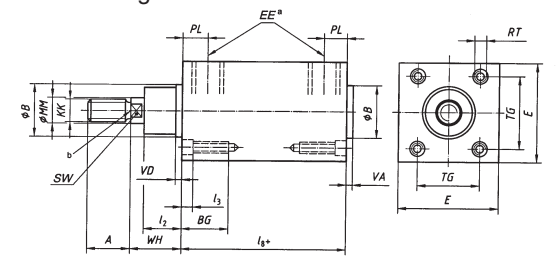
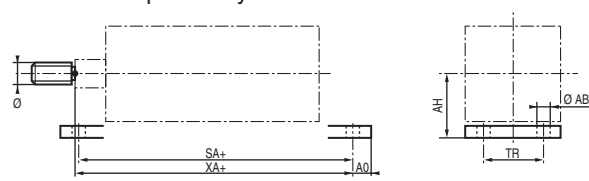
standards of cylinders	INTERCHANGEABILITY	
	within the standard	between standards
<p>ISO 21287 Ø 20 to 100 mm</p> <p>This new international standard defines the outer dimensions of a compact bare cylinder and equipped with its mountings. The center-to-center mounting distances of dia. 32 to 100 mm cylinders are identical to those of standard ISO 15552.</p>  <p>Series 449 cylinders complies with the international standard</p>	<p>Full interchangeability between the manufacturers is achieved at every level:</p> <ul style="list-style-type: none"> • bare cylinder • each mounting • complete unit1 	<p>32 to 100 mm dia. cylinders can be equipped with all mountings to ISO 15552.</p>
<p>ISO 15552 Ø 32 to 320 mm</p> <p>This new international standard cancels and replaces ISO 6431. It defines the outer dimensions of a bare cylinder and equipped with its mountings.</p>  <p>Series 453-454-450 cylinders complies with the international standard</p>	<p>Full interchangeability between the manufacturers is achieved at every level:</p> <ul style="list-style-type: none"> • bare cylinder • each mounting • complete unit1 	
<p>ISO 15552</p> <p>These standards fully include the international standard ISO 15552. The NF ISO 15552 is completed with a definition of the rod diameters MM and cancels and replaces standard NFE 49003 parts 1 to 3.</p> <p>Series 453-450 cylinders complies with the international standard</p>		<p>For full interchangeability with ISO 15552, ISO 6431 cylinder must be equipped with its mountings, and reciprocally.</p>
<p>ISO 6431 (1983)</p> <p>This international standard defined a cylinder unit equipped with its mountings without specifying the bare cylinder alone. It is cancelled and replaced by above standard ISO 15552.</p>  <p>Series 438 cylinders complies with the international standards</p>	<p>Interchangeability between manufacturers is achieved by replacing both the cylinder and its mountings.</p>	

01430GB-2017/R01 Availability, design and specifications are subject to change without notice. All rights reserved.