



Limitorque QX

The Next Generation in Smart Quarter-turn Actuation



Experience In Motion

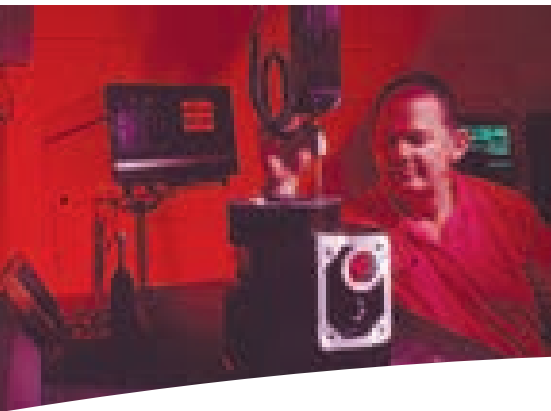

Flowserve Limitorque Actuation Systems

Limitorque is an operating unit of Flowserve, a \$4 billion-plus/year company strongly focused on automation and support of the valve industry. Flowserve is the world's premier provider of flow management services.

Limitorque has evolved over 80 years since its strategic introduction of a "torque-limiting" design that changed an industry. Flowserve Limitorque offers solutions and automation choices for customers that provide:

- Cost savings from field devices such as electric valve actuators
- Greater operating efficiencies from control-room performance sequencing, interlocking and continuous process optimization
- Competitive advantages derived from increased management visibility of databases and networks

Limitorque is one of the primary reasons Flowserve is "Experience In Motion."



The QX speaks your language, whether it's management, technical, financial, operations or service.

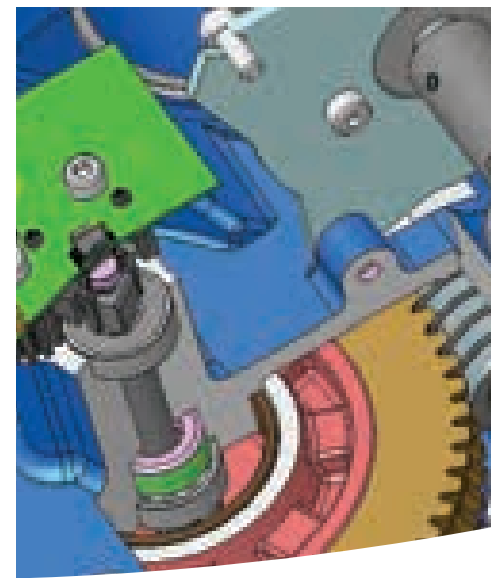
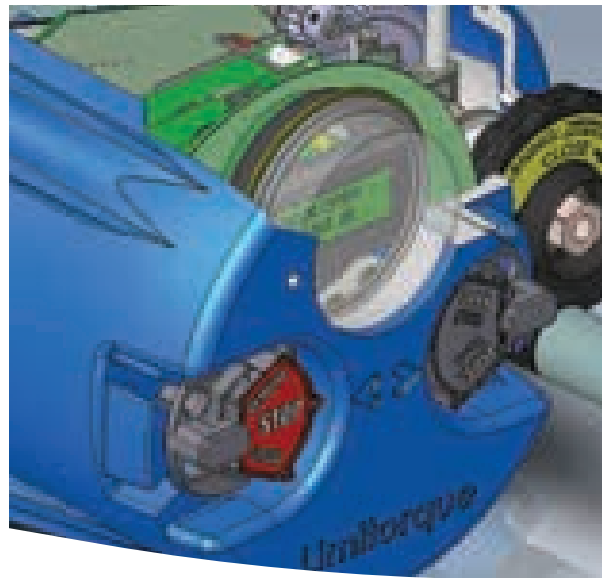

Limatorque QX Smart Valve Actuator

The full measure of safety and reliability in the next-generation smart quarter-turn actuator.

The Flowserve Limatorque QX quarter-turn smart electronic valve actuator continues the legacy of the industry's state-of-the-art, non-intrusive, multi-turn MX actuator by including an absolute encoder for tracking position without the use of troublesome batteries. The QX design provides enhanced safety and reduced downtime through improved diagnostics, built-in self-test (BIST) features and LimiGard™ fault protection.

The QX design builds on more than 10 years of experience with proven Limatorque MX technology—the first-generation double-sealed electronic valve actuator from Flowserve designed to provide control, ease of use and accuracy. The QX includes all the user-preferred features of the MX in a quarter-turn smart actuator package. It is the only non-intrusive, double-sealed quarter-turn actuator to display the Limatorque brand.

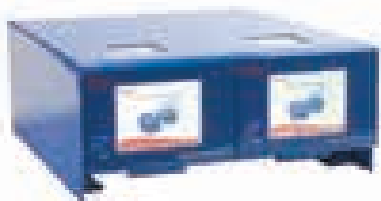

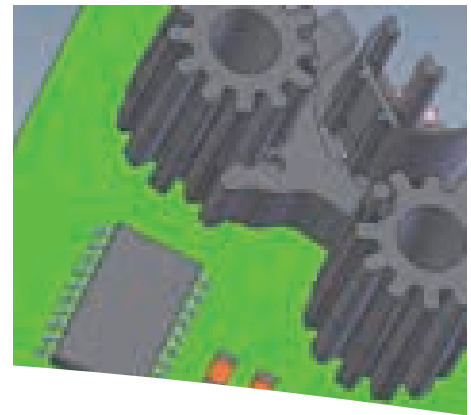

QX: The Next Generation in Smart Quarter-turn Actuation

Speed, Precision and Simplicity

The QX control panel features an improved 32-character LCD screen that provides actuator status and diagnostics in an easy-to-use, easy-to-read, graphical format. The industry's first non-intrusive, quarter-turn multilingual actuator is configurable in English, Spanish, German, French, Italian, Portuguese, Mandarin, Russian, Bahasa Indonesia and Katakana as standard configuration languages. In addition, the LCD can be rotated 180° for better field visibility.

User friendliness, precision, simplicity, and intuitive setup are characteristics expected of a smart actuator. Users and valve OEMs demand quick setup and easy-to-understand dialogue in preferred languages. The ability to either upload new software or download diagnostics is also critical to improving a plant's efficiency. The QX provides customers with the essential tools for rapid installation and root-cause diagnostics.

Precision is expected in a smart actuator. The MX was the first such device developed with an absolute encoder that doesn't require troublesome and unpredictable battery

backup. Flowserve Limitorque's innovative absolute encoder technology, developed for the MX, is used in the QX. The QX encoder employs system-on-chip technology using a contactless magnet that excites Hall-effect devices to provide redundant, 12-bit resolution over 360 degrees. This redundancy, part of the BIST (built-in self-test) feature, means the device can continue to function reliably until a number of faults have been accumulated.

When a device is designed for BIST, its methodology is such that much of the test functionality is embedded in the device itself. BIST design enables a critical component's ability to communicate its actual state to a CPU for comparison to the expected state. Any deviation from expected values will be reported to the user, with correlation to the failed component or subsystem.

Simplicity is expected in a smart actuator. In fact, one of the reasons for using an electronic actuator is the simplicity of setup, installation on a valve and acquiring diagnostic information. The QX is the simplest and easiest to use electronic quarter-turn actuator.



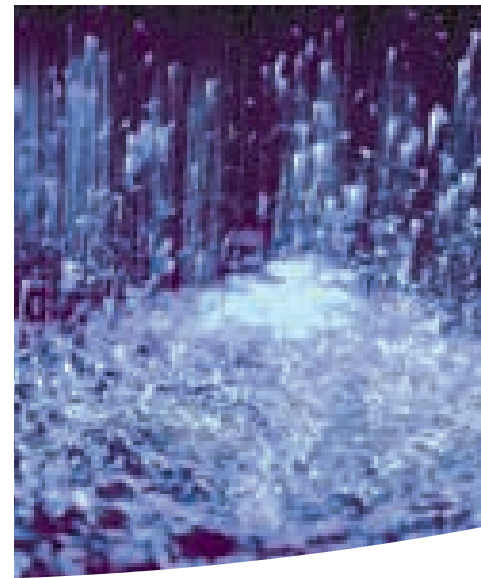
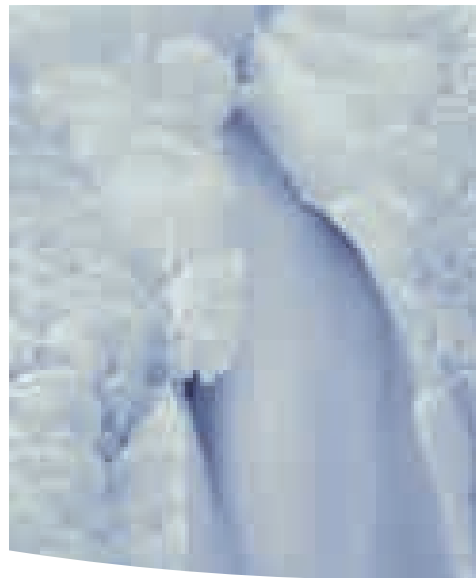

Long Life and Protection

Long life is expected in a smart actuator. There are more than 1,000,000 Limitorque actuators installed around the globe, in every conceivable environment. Many have been functioning for over 50 years. This legendary Limitorque longevity has been carried over into the QX family of smart actuators. The QX has been developed with the ruggedness and dependability users have come to expect from Limitorque actuators for better than 80 years.

In order to last a long time in severe environments, smart actuators must have unparalleled protection. The QX's IP68 enclosure rating is 20M for 168 hours, regardless of whether the unit is weatherproof or explosion-proof. This is an industry-leading feature. Add other certifications to the list – NEMA 4, 4X, 6 – and the QX is unsurpassed in unit protection.

The QX is double-sealed, which isolates the terminal compartment from the controls environment. Any leakage into the terminal compartment is contained in the compartment.

The QX is powder coated using a polyester resin in Dupont Blue Streak color, not only for aesthetics, but also for protection in severe corrosive environments. The use of powder coating ensures that each QX can withstand saliferous conditions without degradation.

Quality and Certifications

Flowserve Limitorque is a global leader in quality manufacturing. All Limitorque plants are certified to ISO 9001 standards, the recognized benchmark for quality all over the world. The same unexcelled use of certified



materials is found in the QX as in Limitorque's naval and nuclear-qualified electric actuators. The MX has used synthetic gear oils especially optimized for use with worm-gear sets since the first unit was shipped in 1997, and the QX is no exception. All lubrication used in the QX is synthetic, capable of temperature extremes from -60°C to +70°C. The MX was the first non-intrusive actuator to use rolled worms and electronic controls designed and produced using surface-mount technology: the QX uses components manufactured with the same advanced technology. A true globally certified device, the QX meets all pertinent European directives including ATEX, EMC, Machinery and Noise, and displays the CE mark associated with such compliance.

Anatomy of QX Quarter-turn Actuators

Limatorque QX actuators respond to customer needs with advanced features designed for ease of commissioning and use, as well as time- and money-saving operational benefits. What sets the QX apart is the combination of control and reliability enabled by advanced Limatorque technology, plus superior ergonomics and human interfaces for speed, comfort, and ease of use.

Brushless DC Motor

Advanced brushless DC motors eliminate sparks, reduce mechanical and electrical noise, and dissipate heat better than brushed motors. Unique to the industry, brushless motors last longer than conventional motors and allow for more accurate positioning while permitting a global range of voltages (single-phase and three-phase AC and DC) to be used without modification.

Terminal Chamber

Double-sealed design provides a termination chamber that is separate and sealed from the control chamber. Control components are never exposed to the elements during site wiring or because of a faulty cable connection.

Absolute Encoder

The QX encoder employs system-on-chip technology using a non-contacting magnet to excite Hall effect devices, providing redundant, 12-bit resolution over 360°. This redundancy, part of the BIST feature, means the device can continue to function reliably until a number of faults have been accumulated.

Worm Gear Set and Motor Gear Attachment

Both the motor gear reducers and worm gear sets are designed with Limatorque performance and longevity in mind. Rolled/ground gears are bearing supported and immersed in an extended life synthetic gear oil specifically designed to improve efficiency and minimize wear.

Drive Sleeve Stop

Drive sleeve stops are supplied for 90° selections and removed for multi-turn applications, up to 20 turns maximum.

Cast Aluminum Housing

The QX housing material is cast 356-T6 grade aluminum. This alloy was selected due to its superior suitability for corrosion resistance in harsh and eroding environments.

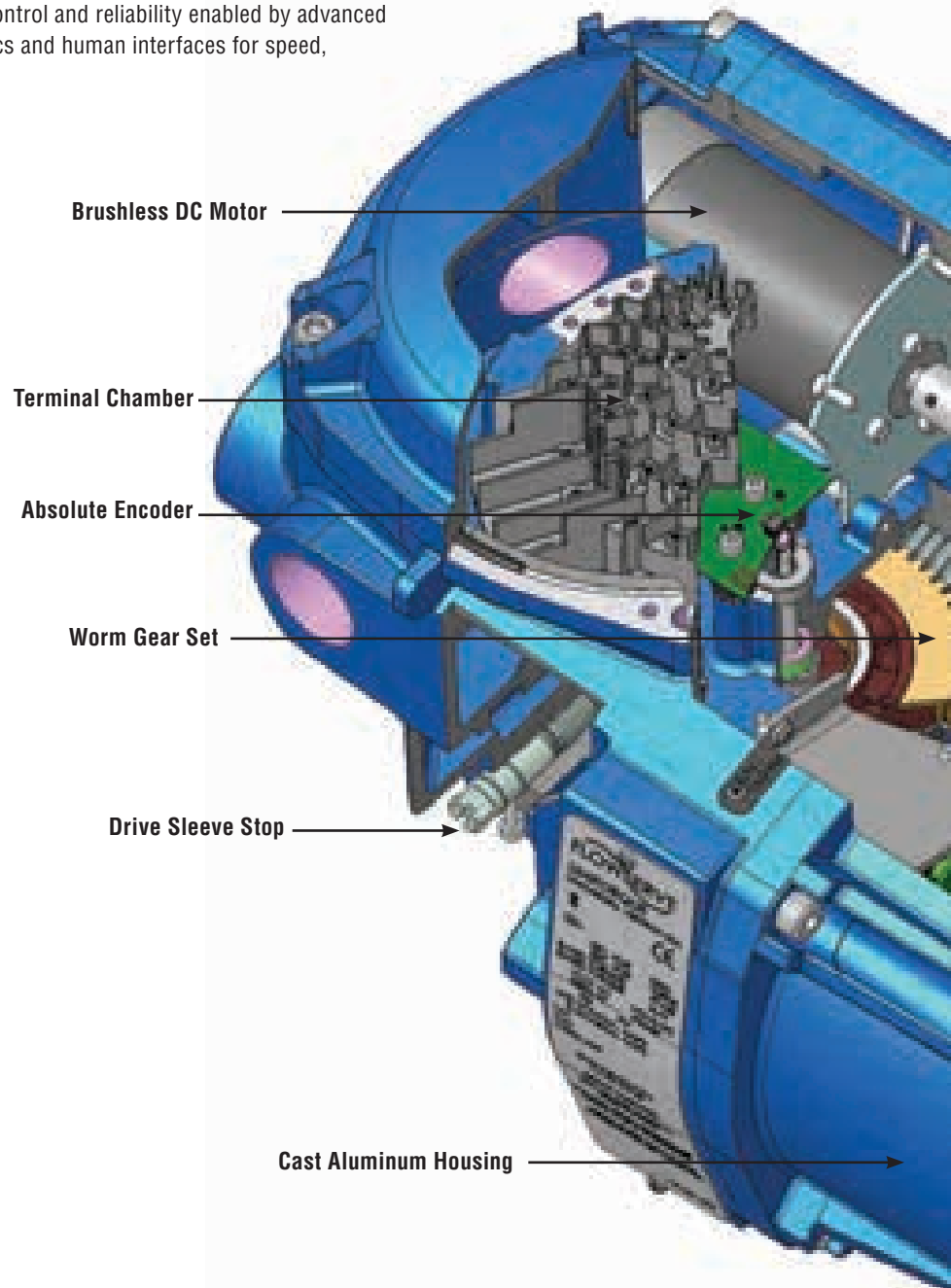

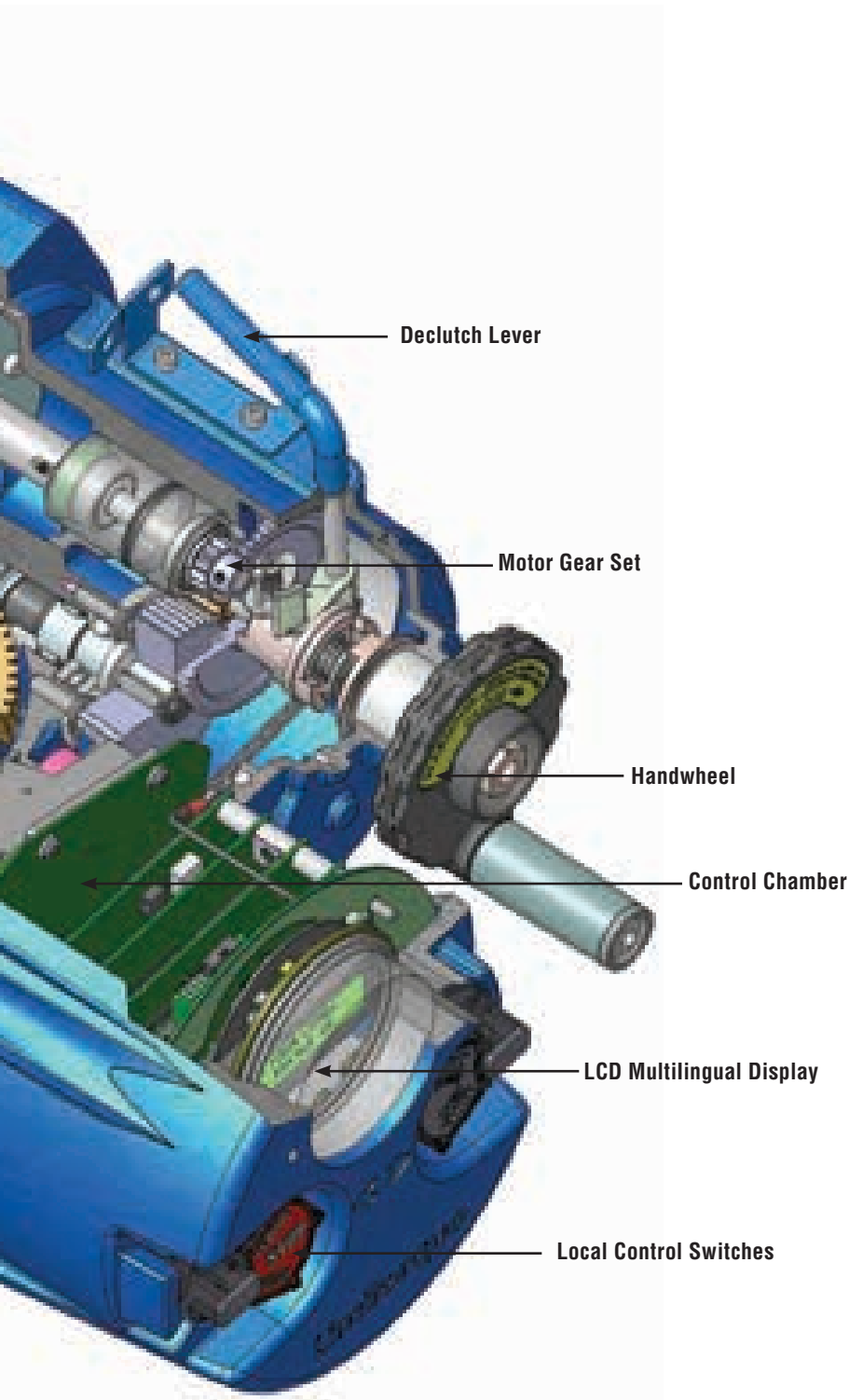

Declutch Lever

Declutch lever enables the QX actuator to be placed in manual, handwheel-drive operation. Lever automatically disengages when motor is energized and can be padlocked in the motor position.

Torque Sensing

The QX continues the Flowserve Limitorque commitment to fully electronic smart actuators with advanced torque sensing. This method of torque control uses motor amperage to sense the valve load and has been verified in temperature extremes from -60°C to +70°C.

Handwheel

QX handwheels are manufactured from an engineered resin and are designed to meet most minimum rim pull requirements. Locating the handwheel adjacent to the LCD and controls facilitates local configuration and operation.

Control Chamber

Utilizing the same electronics package as the state-of-the-art MX, the QX has an additional feature - a solid state motor controller. This design permits almost all customer supplied voltages, single or three phase AC or DC, to be connected without modification to the voltage supply.

LCD Multilingual Display

The control panel display delivers instant, up-to-the-minute actuator status and valve position in 10 languages. It also provides simple calibration and diagnostic information, including motor, identification, and hardware data, as well as torque profile and log reports.

Local Control Switches

Local control switches make setup and calibration easy, using “yes” or “no” responses to straightforward questions, plus they provide the ability to open, stop and close the actuator and to select remote or local preferences. These switches are magnetically coupled, solid-state Hall effect devices, which eliminate troublesome and fragile reed switches.

Control and Diagnostics

Control is expected in a smart actuator. The QX simplifies valve automation in three critical methods of control:

- Calibration/setup
- Normal operation
- Diagnostics and troubleshooting

The MX was the first non-intrusive actuator to equip users with LCD dialogue screens in the language of their choice. The QX has the same language options as the MX and uses a graphical dot matrix display that improves the visibility of the display. The use of this type of LCD permits the support of any language. In fact, in addition to English, Spanish, German, French, Italian and Portuguese, the QX also includes four character-based languages – Mandarin, Russian, Bahasa Indonesia and Katakana – with a capacity for even more.

Simple “Yes” and “No” responses to dialogue questions confirm the setup of the QX via solid-state Hall effect devices in both knobs. No special tools or remote devices are required. And the QX is “fit for service”, offering the widest range of configuration menus of any non-intrusive smart actuator.

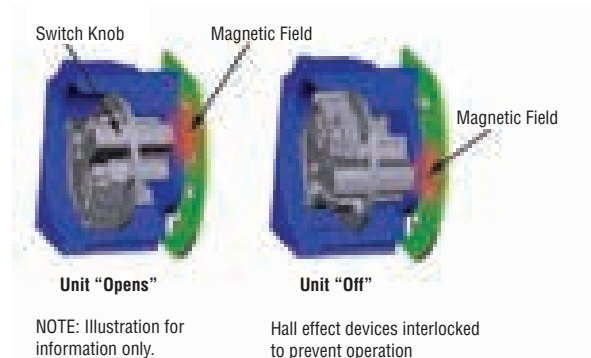

Diagnostics should be easy to read and decipher. The QX diagnostic enhancements now offer a BIST (built-in self-test). The BIST feature is also designed into a state-of-the-art controls platform that verifies and validates the integrity of its components. The result is a design that aids the user in meeting the SIL (Safety Integrity Level) requirements of IEC 61508. Placing a smart device into any plant system enhances the ability of a given safety system to achieve its preferred SIL rating. Any device that incorporates fully developed BIST features provides assurance to the user that the device has been designed with plant-wide safety and integrity of operation in mind.





The “View Diagnostics” menu selections now include more definitive routines that can isolate troubleshooting to “root cause” error codes. These root-cause codes can be used in conjunction with BIST. A well-designed BIST-based system can do more than just report failures in the electronic subsystems: it can also determine failures or predict future failures in its associated mechanical system.

The QX also offers Bluetooth technology as an option, up to 10 meters. When used with the Flowserve Limatorque graphical software interface, Dashboard™, diagnostic information can be transferred easily to a PDA with Windows Mobile 5 or greater, laptop computer or smart cell phone. In addition, off-line configuration changes can be uploaded and actuator configurations transferred from one device to any number of subsequent actuators.

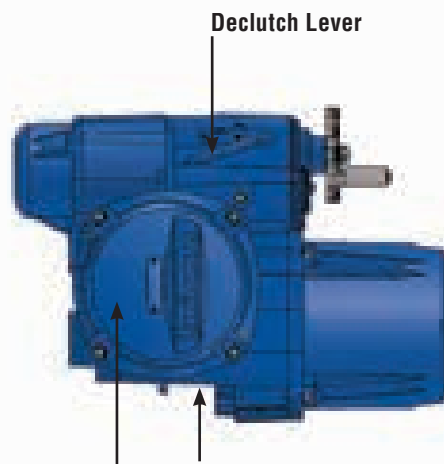

Declutch Lever

Three conduit openings are standard with the option of a fourth.

Terminal Compartment with O-ring seals that permit a double-sealed compartment, isolating the electronic controls from the environment.

Nothing Exceeds Limatorque QX Actuators for Ease and Compatibility with Quarter-turn Valves of All Types

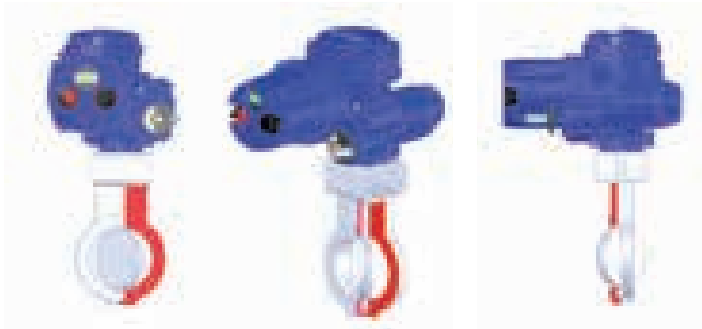

Valves

Limatorque QX actuators have been designed to accommodate today's wide variety of valve designs and configurations and meet international standards for valve and actuator interfaces, including ISO 5210 and MSS SP-102.

Direct mounting: The QX can be directly coupled with all quarter-turn valves for position seated or torque-only applications.

Couplings

Standard B4/B4E Base

The standard QX actuator base includes a mounting base for torque-only or position-seated valves. It also includes a steel torque nut, which may be machined to fit a valve or, if necessary, gearbox. A B4E torque nut can be provided and may be installed to allow for extended stem acceptance.

Available QX Flanges

		QX-1	QX-2	QX-3	QX-4	QX-5
Flange 1	ISO 5210	F05/F07	F07	F10	F12	F12
	MSS SP-102	FA05/07	FA07	FA10	FA12	FA12
Flange 2	ISO 5210	F10	F10	F12 F14	F12 F14	F14
	MSS SP-102	FA10 (STD)	FA10 (STD)	FA12 FA14	FA12 FA14	FA14

Integrity and Predictable Performance

Smart actuators should have enabling technologies that ensure integrity and dependability. The QX offers three.

Limigard — now with BIST and FDA

Enhanced reliability for optimal plant operations and reduced troubleshooting costs are the primary benefits of Limatorque's smart actuator monitor, LimiGard.

When LimiGard wiring diagrams are followed, LimiGard continually monitors the motor controller, internal logic circuits and external command signals, comparing them to reference conditions. This virtually eliminates the possibility that an actuator malfunction can occur without prompt detection and alarm communication. In the event

of a malfunction, LimiGard takes over and supervises the actuator's response characteristics, maximizing safety and predictability.

A state-of-the-art electronic actuator, such as the QX, includes means for verifying and validating that its components are designed with built-in self-test (BIST) capabilities. Selecting the QX, which incorporates a high level of BIST, can contribute greatly to the integrity and reliability of process applications and enhance the ability of a safety system to achieve its highest possible SIL rating.

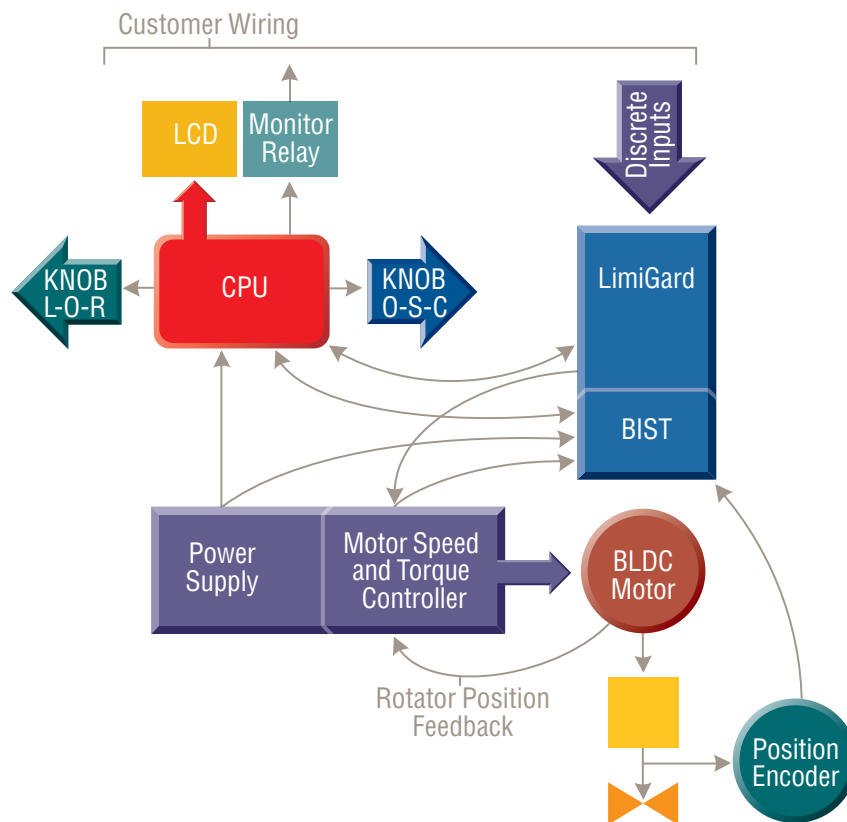



Absolute position encoder

Limatorque was the first to use absolute encoders in smart electronic actuators. An absolute encoder simplifies valve automation from configuration and setup into normal operations, diagnostics and troubleshooting. The QX encoder employs system-on-chip technology using a contactless magnet that excites Hall-effect devices to provide redundant, 12-bit resolution over 360 degrees. This redundancy, part of the BIST features, means the device can continue to function reliably until a number of faults have been accumulated.

As the actuator turns, a mechanical coupling rotates the magnet about an array of several Hall-effect devices. When the magnet passes over a Hall-effect device, it causes a change in the electromagnetic field, and a digital signature (on-off) is developed. This signature is duplicated across the array of Hall-effect devices at specifically timed intervals, resulting in digital values that calculate the position of the valve via the electronic actuator.

Torque sensing

Torque limiting has been a Limatorque feature for better than 75 years. In fact, the name Limatorque was coined to identify the ability of an electric actuator to “limit torque” to a valve. In the past, electromechanical actuators have sensed torque using a complicated system of springs, switches and cams. The QX senses torque electronically for use in valve control, overload protection and torque trending. In conjunction with the Limigard feature, torque is sensed from motor current, with compensation performed for voltage and temperature variations. The result is highly reliable and predictable torque sensing without the need for the extra components associated with electromechanical torque switches. The QX is a true smart actuator.

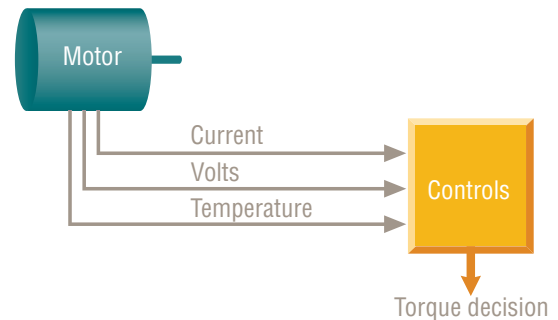

QX Control, Indication, Protection and Optional Features

Standard features

- Direct-wired remote control – Wiring flexibility includes the following standard alternatives to open-stop-close the actuator:
 - Four-wire – Valve can be opened, closed or stopped.
 - Two-wire switched – Single open or closed contact; valve can be opened or closed but not stopped.
 - Three-wire maintained – Two momentary contacts for self-maintained control. Valve can be opened or closed but not stopped in mid-travel.
 - Three-wire inching – Two “push-to-run” contacts; valve can be opened, closed and stopped in mid-travel.



- Multi-mode Control – Three modes of remote control are permitted when the QX is configured for multi-control: digital (discrete) control, analog control or network (fieldbus) control. The QX will respond to the last command received. However, analog (modutronic) control is initiated by either toggling QX User Input 2 (configured for CSE input) or removing and reapplying the 4-20 mA analog signal. Refer to LMENTB2300 for further information.
- Monitor relay – Provides a N/O and N/C contact representing “Actuator available for remote operation.”
- Emergency Shutdown (ESD) – Up to three remote, external ESD signals may be applied to the actuator to move the valve to a predetermined, user-configured shutdown position, overriding existing control signals.
- User-defined inputs – Three user-defined inputs are supplied.
- Inhibit signals – External signals may be used to inhibit actuator opening, closing or both.
- Control signals – The control signal can be either 24 VDC or optional 110 VAC; it can be sourced from the actuator or customer supply.
- Status contacts (two pairs) – May be set to represent up to 25 actuator conditions.
- Alternate speeds – The QX can be configured to permit differing speeds for Open or Close direction.

Protection features

- Autophase protection and correction – Ensures proper open/close directions and monitors and corrects phasing if connected improperly. Prevents operation if a phase is lost.
- Jammed valve – Automatically initiates a forward/reverse cycle to free jammed valves.
- Instantaneous reversal protection – Incorporates a time delay between the motor reversals to reduce current surges.
- Motor thermal protection – A thermistor, placed within the motor, protects against overheating.
- LimiGard™ circuit protection – QX actuators include LimiGard circuit protection. LimiGard consists of dedicated circuitry that continually monitors the motor controller, control relays, internal logic circuits and external command signals. When the recommended wiring connections are made, it virtually eliminates unexpected, erroneous actuation caused by internal electronic failures and erratic external command signals. Additionally, in the event of malfunction, LimiGard supervises the actuator response, detects the source of the failure and signals an alarm.

Optional features

- Alarm contacts – Up to eight latched contacts may be set to represent up to 25 key actuator conditions.
- Two-speed timer – A two-speed pulsing timer may be incorporated to support variable stroke times as configured by the user.
- Analog Position Transmitter (APT) – The APT is an internally powered, non-contacting valve position transmitter that provides a 4-20 mA signal proportional to valve position.
- Analog Torque Transmitter (ATT) – The ATT is a non-contacting, internally powered transmitter that provides a 4-20 mA signal that is proportional to actuator output torque.
- Modutronic controller – The Modutronic controller positions the valve in response to an external 4-20 mA command signal. It includes automatic pulsing mode to prevent overshoot at the set point. Parameters that may be set easily during configuration include proportional band, dead band, polarity and action on loss of command signal.
- QX Modulating – The QX can be configured for modulating operation that requires greater than 600 starts per hour. It is available for up to 1800 starts per hour.
- Partial stroke and momentary closure ESD – The QX can be supplied with the ability to perform a partial stroke operational parameter. The partial stroke and momentary closure ESD signals are configurable by the user. It can also be supplied with a momentary closure contact initiated ESD signal routine with redundant circuitry.
- Control Station (CSE) – The CSE is a separate control station designed for the operation of inaccessible actuators. It is available with LEDs, Remote/Local and Open/Close selector switches. The CSE may be powered by the actuator's internal supply, provided wire resistance and other external loads do not limit the available signal power presented to the QX.
- Isolation and Load Break Switches – Isolation and Load Break Switches can be supplied for the incoming voltage supply to the actuator. These may be coupled directly to the actuator for weatherproof (WP) applications only or supplied separately for mounting by user. The enclosure is suitable for weatherproof or temporary submersion service. An explosion-proof (XP) isolation switch is also available for user mounting and is suitable for mounting with all QX actuators. Please contact factory for availability.
- Negative Switching – When remote control systems require the negative pole of the circuit supply to be switched to positive earth, a simple software change is made.
- QX Quik – After the actuator has been powered by line power for one hour, it will automatically withstand most power outages while maintaining the correct state of the Status and Alarm (S or R) contacts—even if the user repositions the actuator manually with the handwheel. To maximize its self-power time while the line power is lost, the actuator places itself in its lowest possible power usage mode. The LCD will darken (sleep mode) until it is activated for viewing. The LCD can be activated by moving the black knob to OPEN (YES) or by moving the actuator with the handwheel. After seven to eight seconds of inactivity, the LCD will return to sleep mode.



Bluetooth-capable options

Standard low-power wireless communication path to the actuator enables monitoring and configuration of the unit up to 10m in any direction via a Bluetooth-equipped PC, PDA, smart cell phone, etc. FHSS (Frequency Hopping Spread Spectrum) allows a reliable communication link even in a “noisy” environment and 128-bit data encryption can be enabled to protect the privacy of the link. QX Dashboard configuration/diagnostic tools can use the Bluetooth link as a means for communicating with the actuator. A visible blue LED in the control's LCD window on the face of the actuator signifies an active Bluetooth link to the actuator has been established.

Network Communications

The QX provides a comprehensive network option portfolio to the user. Network solutions are improved with the addition of DeviceNet to complement Modbus, FOUNDATION Fieldbus H1, Profibus DP_V1 and Profibus PA. The QX provides the user with predictable, reliable and safe operation for years to come, in applications that are subject to the most rigorous requirements and environmental extremes.

DDC (Distributed Digital Control) Modbus communication

DDC is Flowserve Limitorque's digital communication control system that provides the ability to control and monitor up to 250 actuators over a single twisted-pair cable. The communication network employs Modbus protocol on an RS-485 network and is redundant. Redundancy ensures that any single break or short in the communication cable will not disable any actuators. Each actuator has included an addressable field unit that communicates over the twisted-pair network and executes open, close, stop, ESD and GO

TO position commands. The field unit also communicates all actuator status and alarm diagnostic messages over the same communication network.

DDC Network

- Single-ended loop (consult factory)
- Modbus protocol
- High speed – up to 19.2 k baud



Master Station III

QX units equipped with DDC can be controlled via Flowserve Limatorque's Master Station III. It includes:

- Host interface – Industry standard Modbus Rtu, ASCII, UDP, and TCP/IP protocols and control
- 5.6" TFT touch-screen display for network configuration status
- Configurable polling sequence priority
- Network time protocol for time synchronization of alarms/diagnostics data to host device
- Modular hot-swappable redundant design
- E-mail notifications of alarm conditions
- Data/event logging

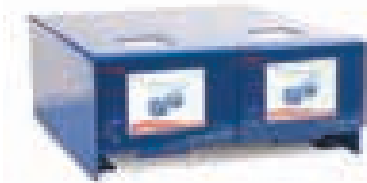

FOUNDATION Fieldbus communication with DTM technology

The QX can be fitted with FOUNDATION Fieldbus protocol that complies with the IEC 61158-2 Fieldbus H1 standard. The field unit device is able to support several topologies such as point-to-point, bus with spurs, daisy chain, tree or a combination of these. The FF device has network features that include:

- Link Active Scheduler that controls the system
- High-speed communications up to 31.25 kbits/sec
- Publisher-subscriber communication
- Input and output function blocks
- Device descriptions
- Network communication
- Configurable by user

Link Active Scheduler communication: Fieldbus segments have one active Link Active Scheduler (LAS) at a given time, which is the bus arbiter, and does the following:

- Recognizes and adds new devices to the link
- Removes non-responsive devices from the link
- Schedules control activity in, and communication activity between, devices

- Regularly polls devices for process data
- Distributes a priority-driven token to devices for unscheduled transmissions

The Limatorque MX and QX actuators utilize Flowserve ValveSight™ to monitor the status, alarms and health of both the valve and actuator. Embedded predictive diagnostics provide an advanced warning of pending problems, thus minimizing unscheduled plant shutdowns and loss of productivity.

The result is a paradigm shift in valve and actuator maintenance. When you are monitoring for the conditions that would lead to an alarm rather than reacting to alarms and optimizing your process rather than servicing broken actuators, you are putting your maintenance dollars where they deliver the most ROI.

- Reduces commissioning time, maintenance and related operating costs
- Improves productivity by providing a user-friendly graphical interface
- Increases efficiency by enabling network users to communicate in real time with the device and monitor diagnostics information, including alarms
- Interfaces for offline and online parameterization, configuration, reading status and diagnostic data

HART Communication

The HART (Highway Addressable Remote Transducer) Protocol is the global standard for sending and receiving digital information across standard twisted-pair instrumentation cable connecting smart field devices and control/monitoring systems.

Limatorque QX (and MX) actuators are certified for use by the HART Communication Foundation (HCF).

Features and Benefits

The following commands and feedback information can be transmitted and received by MX/QX HART unit:

- OPEN, CLOSE and STOP commands
- ESD (emergency shutdown) commands
- Partial stroke test commands
- Go-to-position commands
- Unit output torque (0–100% rating)
- Actuator status, alarm and diagnostic messages
- Burst messages
- Travel histogram
- Event notifications
- LimiGard™ patented signal monitoring

(Patent US5719559 A granted 1998; expiration 2018)

PROFIBUS DP V1 communication with DTM

The QX can be fitted with Profibus DP_V1 protocol field units that comply with EN50170 Fieldbus Standard for RS-485 communications. The device supports several topologies such as point-to-point, bus with spurs, daisy chain, tree or a combination of these. The PB device has network features that include:

- High-speed communications up to 1.5 Mbps
- Master-to-slave communication
- Standby communication channel
- Analog and digital input and output function blocks
- Device descriptions configurable by user
- High-Speed Data Exchange – Startup Sequence
- Power On/Reset – Power On/Reset of master or slave
- Parameterization – download of parameters into field device (selected during configuration by the user)
- I/O Configuration – download of I/O configuration into the field device (selected during configuration by the user)
- Data Exchange – cyclic data exchange (I/O Data) and field device reports diagnostics
- Redundant Profibus DP with single or multiple – master communications

PROFIBUS PA communication with DTM

A Profibus PA protocol is available and complies with EN50170 Fieldbus Standard and Fieldbus physical layer per IEC 61158-2 for communications. The device supports several topologies such as point-to-point, bus with spurs, daisy chain, tree or a combination of these. The PB device has network features that include:

- High-speed communications up to 31.25 kbits/s with Manchester coding
- Master-to-slave communication
- Bus powered for 9-32 VDC and 15 mA per actuator
- Standby communication channel
- Analog and digital input and output function blocks
- Device descriptions
- Configurable by user

The Profibus DP-V1/PA DTM V 1.0 is a software component that contains device-specific application information. The DTM can be integrated into engineering and FDT frame applications, such as stand-alone commissioning tools or asset management systems that are equipped with FDT interfaces. FDT technology is independent from any specific communication protocol, device software or host system, allowing any device to be accessed from any DCS host through any protocol.

DeviceNet

DeviceNet complies with CAN-based protocol and provides the following features:

- DeviceNet Group 2 Server implementation
- Master-to-slave communication
- Bus-powered network interface allows power alarm information to be communicated when actuator loses main power; the actuator does NOT drop off the network when power is lost
- Standard polled I/O connection
- Standard bit strobed I/O connection
- Standard change of state/cyclic I/O connection
- Standard explicit connections defined as:
 - Various assembly objects and sizes that allow the network user to determine how much data to transfer to accommodate network installation data throughput requirements
 - Automatic baud rate detection
 - Node address configurable via local setup menu or via the remote network user
 - Broadcast or group network originated ESD support



QX Multi-turn

- The industry-leading feature set of the QX has been extended to a multi-turn version, the QXM. The QXM is available for up to 20 turns with increased speed ranges from 2 to 24 rpm. When combined with faster speeds, the torque ranges are consistent with the speed required for limited linear travel. All of the MX and QX features are included in the QXM. In fact, an A1 and/or LB (linear base) base can be attached to the QXM for travel up to 70 mm.
- An absolute encoder that simplifies valve automation from configuration and setup into normal operations, diagnostics and troubleshooting. The QXM encoder employs system-on-chip technology using a contactless magnet that excites Hall effect devices to provide redundant, 12-bit resolution over either 6.5 or 20 turns, resulting in resolutions of 0.65 degrees or 2.2 degrees, respectively.
- Available with two distinct motors (“H” version is “high” torque and “L” version is “low” torque) to offer a broad torque and speed range, from 18 ft-lb (24 Nm) to an industry-leading 250 ft-lb (337 Nm). The motors have H class insulation as standard and are rated to IEC 34 as S2_15 min_40%.
- The QXM is available with all pertinent global explosion and weatherproof certifications – FM, FM Canada, ATEX and IECEx.



Size	Speed (rpm)	Torque		Time to Close (sec)	
		(ft-lb)	(N m)	6.5 Turns	20 Turns
QXM-1	3	100	135	130	400
QXM-2	2	250	337	195	600
QX-1/MH - 6	6	90	120	65	200
QX-1/ML - 6	6	45	60	65	200
QX-1/MH - 12	12	84	113	33	100
QX-1/ML - 12	12	40	54	33	100
QX-1/MH - 18	18	60	81	22	67
QX-1/ML - 18	18	30	40	22	67
QX-1/MH - 24	24	43	58	16	50
QX-1/ML - 24	24	18	24	16	50

QX1 - QX5 Performance Ratings

Description	QX-1	QX-2	QX-3	QX-4	QX-5
Minimum Operating Time (sec*)	5	8	15	30	60
Maximum Operating Time (sec)	20	30	60	120	120
Rated Seating Torque: seating (ft-lb/Nm)	100/136	250/339	400/542	750/1017	1500/2033
Seating Torque Limited by Base	Not Applicable	07 base 200 ft-lb (271 Nm) max	Not Applicable	Not Applicable	12 base 1000 ft-lb (1356 Nm) max
Run Torque: 20% (ft-lb/Nm)	20/27	50/68	80/108	150/203	300/407
Run Torque 50% (ft-lb/Nm)	50/68	125/169	NA	NA	NA
Stall Torque (ft-lb/Nm)	200/271	500/677	800/1083	1500/2031	3000/4063
Motor Seating Rating (in-lb/Nm) 1ph & 3ph	5/56	12/1.36	5/56	12/1.36	12/1.36
Motor Run Rating (in-lb/Nm) 1ph & 3ph	1/11	2.4/27	1/11	2.4/27	2.4/27
Motor Stall Rating (in-lb/Nm) 1ph & 3ph	6.5/73	15.6/1.76	6.5/73	15.6/1.76	15.6/1.76
Gear Ratio Motorized	985	985	3662	3662	7212
Gear Ratio Handwheel	200	200	276	276	276
Handwheel Efficiency	26%	26%	26%	26%	26%
Handwheel Diameter (in/mm)	3/76	3/76	7.5/190	7.5/190	7.5/190
Handwheel turns for 90°	50	50	70	70	70
Handwheel Shaft Octagon Interface to Handwheel (in/mm)	.77/19.5	.77/19.5	.77/19.5	.77/19.5	.77/19.5
Handwheel Shaft Hex Drive (in/mm)	.63/16	.63/16	.63/16	.63/16	.63/16
MSS SP-101 Base FA/ISO 5211 Base F	05, 07, 10	07, 10	10/12/14	12/14	12/14
Max Diameter Bore & Square Key (inches)	05 Base Ø.875, 3/16 sq 07 Base Ø1.1875, 1/4 sq 10 Base Ø1.625, 3/8 sq	07 Base Ø1.1875, 1/4 sq 10 Base Ø1.625, 3/8 sq	10 Base Ø1.625, 3/8 sq 12 & 14 Base Ø2.375, 5/8 sq	12 & 14 Base Ø2.375, 5/8 sq	12 & 14 Base Ø2.375, 5/8 sq
Max Diameter Bore & Rectangular Key (inches)	05 Base Ø.93, 3/16 X 1/8 07 Base Ø1.25, 1/4 X 3/16 10 Base Ø1.75, 3/8 X 1/4	07 Base Ø1.25, 1/4 X 3/16 10 Base Ø1.75, 3/8 X 1/4	10 Base Ø1.875, 1/2 X 3/8 sq 12 & 14 Base Ø2.50, 5/8 X 7/16	12 & 14 Base Ø2.50, 5/8 X 7/16	12 & 14 Base Ø2.50, 5/8 X 7/16
Max Diameter Bore & Key (mm)	05 Base Ø22, 6 sq 07 Base Ø30, 8 X 7 10 Base Ø42, 12 X 8	07 Base Ø30, 8 X 7 10 Base Ø42, 12 X 8	10 Base Ø50, 14 X 9 12 & 14 Base Ø64, 18 X 11	12 & 14 Base Ø64, 18 X 11	12 & 14 Base Ø64, 18 X 11
Max Square Drive	05 Base 0.75 in sq, 19 mm sq 07 Base 1 in sq, 25 mm sq 10 Base 1.41 in sq, 35 mm sq	07 Base 1 in sq, 25 mm sq 10 Base 1.41 in sq, 35 mm sq	10 Base 1.625 in sq, 42 mm sq 12 & 14 Base 1.75 in sq, 45 mm sq	12 & 14 Base 1.75 in sq, 45 mm sq	12 & 14 Base 1.75 in sq, 45 mm sq
Max Double 'D' Diameter (in/mm)	05 Base Ø1.06 in/27 mm 07 Base Ø1.44 in/36 mm 10 Base Ø2.00 in/50 mm	07 Base Ø1.44 in/36 mm 10 Base Ø2.00 in/50 mm	07 Base Ø2.25 in/58 mm 12 & 14 Base Ø2.50 in/64 mm	12 & 14 Base Ø2.50 in/64 mm	12 & 14 Base Ø2.50 in/64 mm
Weight (lb)	40	42	80	80	80
Coatings	Primed using high solids epoxy-ecoat and powder topcoated, royal blue with a DFT of 1–3 mils. The coating is suitable for an ASTM B117 salt spray test of 1500 hours. Standard external fasteners are stainless steel.				

*QX minimum operating times are impacted by temperatures less than -10°C.

QX-1 if set between 5-10 seconds will run slower, requiring 10 seconds for 90 degrees

QX-2 if set between 8-10 seconds will run slower, requiring 10 seconds for 90 degrees

QX-3 if set between 15-30 seconds will run slower, requiring 30 seconds for 90 degrees

QX-4 if set between 30-60 seconds will run slower, requiring 60 seconds for 90 degrees

Information on base torque limits

05 base is limited to 100 ft-lbs/135 Nm max

07 base is limited to 200 ft-lbs/270 Nm max

10 base is limited to 400 ft-lbs/542 Nm max

12 base is limited to 1000 ft-lbs/1350 Nm max

QX Standard Features

The Flowserve Limatorque QX quarter-turn, smart electronic valve actuator is designed for the reliable operation of either ON-OFF or modulating quarter-turn valves. It includes a brushless DCV motor as standard, which can auto-correct to accept any global input voltage, single- or three-phase AC, or DC, an absolute encoder, electronic torque sensing, complete electronic control including a motor control board, state-of-the-art protection, control and monitoring features, mechanical gear reduction including worm gear as final output drive, declutch mechanism and handwheel for manual operation, valve interface bushing, 32-character LCD, local and remote control switches, built-in self-test (BIST) features and LimiGard fault protection. These features are all contained in a non-intrusive enclosure that is double-sealed to NEMA 4, 4X, 6, IP68 to 20M for 168 hours (and explosion-proof as required).

Power transmission and lubrication

All mechanical gearing components are bearing supported, and final drive (output) consists of a hardened alloy steel worm and alloy worm gear. All gears are immersed in an oil-bath lubricated with a synthetic oil designed specifically for extreme pressure worm and worm gear transmission service. Special lubricants are available for operation in temperatures of less than -30°C. Consult factory.

LUBRICATION & TEMPERATURE RANGE	SYNTHETIC BRAND
Standard Lubrication, -30°C to +70°C	Petro-Canada SHB 68 or Mobil SHC 626
Optional Food Grade Lubrication, -30°C to +70°C	Dow Molykote

Motor

The QX motor is unique to quarter-turn electronic valve actuators. It is a brushless DC motor specifically designed for the QX actuator and complies with IEC 34, S2-50 percent duty cycle at 50 percent of rated torque. The motor is a true bolt-on design with a quick-disconnect plug that can be changed rapidly without sacrificing motor leads. It is equipped with a solid-state motor thermistor to prevent damage due to temperature overloads.

ON-OFF MODULATING

Standard insulation class is F to IEC 34, S2-50% for stated operating times
100-600 starts per hour

600-1800 starts per hour, IEC 34, S4_50%_1800 S/H

The QX motor permits a global range of voltages (single-phase and three-phase ACV and DCV) to be connected without modification. The motor can energize, provided either of the listed voltages are connected:

Phase/Frequency	Application Voltage
VDC	24-48
1ph – 60 Hz	110, 115, 120, 240
1ph – 50 Hz	220-250
3ph - 60 Hz	208, 220, 230, 240, 380, 440, 460, 480, 550, 575, 600
3ph - 50 Hz	220, 380, 400, 415, 440, 525



Electronic control modules

Non-intrusive

The QX is non-intrusive, which means that all calibration/configuration is possible without removing any covers and without the use of any special tools. All calibration is performed in clear text languages; no icons are used. All configuration is performed by answering the “YES” and “NO” questions displayed on the LCD. “YES” is signaled by using the OPEN switch and “NO” by using the CLOSE switch, as indicated adjacent to the switches.

Double-sealed terminal compartment and terminal block

All customer connections are located in a terminal chamber that is separately sealed from all other actuator components. Site wiring doesn't expose actuator components to the environment. The internal sealing within the terminal chamber is suitable for NEMA 4, 6, and IP68 to 20M for 168 hours. The terminal block includes screw-type terminals; three for power and 54 for control. Customer connections are made via conduits located in the terminal housing.

Three Standard Conduit Openings
(NPT threads standard, M optional)

(3) – 1.0” NPT (standard) or M25 (optional)

Optional Fourth Conduit Opening (NPT or M)

(1) – 1.25” NPT or M32

Controls

The controls are all solid state and include power and logic circuit boards and a motor controller that performs as the motor reverser, all mounted to a steel plate and attached in the control compartment with captive screws. All internal wiring is flame resistant, rated 105°C, and UL/CSA listed.

The controls are housed in the ACP (Actuator Control Panel) cover, and the logic module uses solid-state Hall-effect devices for local communication and configuration. A 32-character, graphical LCD is included to display valve position as a percent of open, 0-100% and current actuator status. Red and green LEDs are included to signal ‘Opened’ and ‘Closed,’ and are reversible, and a yellow LED to indicate ‘Valve Moving.’ A blue LED is included when the Bluetooth option is ordered. A padlockable LOCAL-STOP-REMOTE switch and an OPEN-CLOSE switch are included for local valve actuator control

Using the knobs and LCD screen the QX is configurable in 10 languages: English, Spanish, French, German, Portuguese, Italian, Mandarin, Russian, Bahasa Indonesia and Katakana.

S contacts for remote indication

As standard, two pairs of latched status contacts rated 125 VAC, 0.5 A and 30 VDC, 2 A are provided for remote indication of valve position, configured as 1-N/O and 1-N/C for both the open and closed positions. Two contacts may be configured to represent any other actuator status and the other two will be complementary. The contacts may be configured in any of the selections depicted in the “Actuator Status Message” column.

“S” Contact AC	“S” Contact DC
0.5 Amps @ 125 VAC	1A @ 50 VDC, 2A @ 30 VDC (Resistive)



Actuator Status Message	Function
"CLOSED"	- valve closed "(0% OPEN)"
"OPENED"	- valve open "(100% OPEN)"
"CLOSING"	- valve closing
"OPENING"	- valve opening
"STOPPED"	- valve stopped in mid-travel
"VALVE MOVING"	- either direction
"LOCAL SELECTED"	- red selector knob in "LOCAL"
"MOTOR OVERTEMP"	- thermistor range exceeded
"OVERTORQUE"	- torque exceeded in mid-travel
"MANUAL OVERRIDE"	- actuator moved by handwheel
"VALVE JAMMED"	- valve can't move
"CLOSE TORQUE SW"	- torque switch trip at "CLOSED"
"OPEN TORQUE SW"	- torque switch trip at "OPEN"
"LOCAL STOP/OFF"	- red selector knob at "STOP"
"LOST PHASE"	- one or more of the incoming supply lost
"ESD SIGNAL"	- signal active
"CLOSE INHIBIT"	- close inhibit signal active
"OPEN INHIBIT"	- open inhibit signal active
"ANALOG IP LOST"	- 4-20 mA not present
"REMOTE SELECTED"	- red selector in "REMOTE"
"HARDWARE FAILURE"	- indication
"NETWORK CONTROLLED"	- permits relay control via DDC, FF, or other network driver
"FUNCTION"	- LimiGuard circuit protection activated
"MID-TRAVEL"	- valve position, 1-99% open
"CSE CONTROL"	- CSE station in LOCAL or STOP and controls actuator

Monitor relay for remote indication

A monitor relay is included as standard and trips when the actuator is not available for remote operation. Both N/O and N/C contacts are included, rated 125 VAC, 0.5 A and 30 VDC, 2 A. The monitor relay can be configured for three additional fault indications: lost phase, valve jammed and motor Overtemp. The yellow LED will blink when the monitor relay is active. The user can disable the monitor relay, if necessary.

Monitor Relay AC	Monitor Relay DC
0.5 Amps @ 125 VAC	2A @ 30 VDC (Resistive)

Remote control

Discrete remote control (user supplied) may be configured as two, three or four wires for Open-Stop-Close control. Remote control functions may be powered by external 24 VDC, 110 VAC, or the actuator's internal 24 VDC supply or optional 110 Vac supply. The internal supplies are protected against over current and short circuit faults and utilize optical isolation

to minimize electromagnetic interference. Discrete control provides isolated commons for up to three selections.

Signal Threshold for Voltage Values	Maximum Load
5.0 VAC/VDC maximum 'OFF'	24 VDC + 2 mA
19.2 VAC/VDC minimum 'ON'	110 VAC + 10 mA

Speed control

The QX permits operational speeds in either Open and Closed directions to be set independently of each other. The QX also has an industry leading span for the optional two-speed timer.

Speed Minimum (Open to Close)	Speed Maximum (Open to Close)	Two-Speed Timer Span "ON" Pulse	Two-Speed Timer Span "Off" Pulse
QX-1 = 5 seconds	QX-1 = 20 seconds	0.5 to 20 seconds (0.5 sec. increments)	1.0 to 200 seconds (1.0 sec. increments)
QX-2 = 8 seconds	QX-2 = 30 seconds	0.5 to 20 seconds (0.5 sec. increments)	1.0 to 200 seconds (1.0 sec. increments)
QX-3 = 15 seconds	QX-3 = 60 seconds	0.5 to 20 seconds (0.5 sec. increments)	1.0 to 200 seconds (1.0 sec. increments)
QX-4 = 30 seconds	QX-4 = 120 seconds	0.5 to 20 seconds (0.5 sec. increments)	1.0 to 200 seconds (1.0 sec. increments)
QX-5 = 60 seconds	QX-5 = 120 seconds	0.5 to 20 seconds (0.5 sec. increments)	1.0 to 200 seconds (1.0 sec. increments)





Software

Limigard

A dedicated circuit to prevent undesired valve operation in the event of an internal circuit fault or erratic command signal is included as standard on each Limitorque electronic actuator. A single point failure will not result in erratic actuator movement nor will an open or short circuit in the internal circuit board logic energize the motor controller. The command inputs are optically coupled and require a valid signal pulse width from at least 250 ms to 350 ms to either turn on or off. In the event of an internal circuit fault, an alarm is signaled by tripping the monitor relay and through LCD indication. The control module also includes an auto reversal delay to inhibit high-current surges caused by rapid motor reversals.

Phase detection and correction (three phase)

A phase correction circuit is included to correct motor rotation faults caused by incorrect site wiring or phase switching in the event of a power down. The phase correction circuit also detects the loss of a phase and disables operation to prevent motor damage. The monitor relay will trip and an error message is displayed on the LCD screen when loss of phase occurs.

Multi-mode remote control

The QX is capable of being configured for multi-mode remote control, which permits discrete wiring for either two, three or four wires, or network (Fieldbuses) for Open-Stop-Close control and responds to the last signal received. The actuator can also distinguish analog control for modulating applications. The QX and MX products from Limitorque are the only smart actuators with such features.

ESD

An Emergency Shutdown (ESD) provision is included in each actuator, and the QX has up to three configurable inputs for ESD. The ESD signal(s) can be selected to override any existing signal and send the valve to its configured emergency position. Provision for an isolated common is standard.

Inhibits

The QX has as standard provisions for inhibit movement and also contains up to three configurable inputs. Provision for an isolated common is also standard.

Diagnostics

The QX contains similar diagnostic facilities as the MX. The values are included to accumulate and report the performance of the motor, encoder, motor controller, cycle time, handwheel operations, actuator ID, firmware revision and output turns. In addition, a torque profile of the reference baseline valve stroke and the last valve stroke is included. A feature for resetting the diagnostic odometer is also provided. All diagnostic information is displayed on the LCD and can be acquired over a network if Fieldbus options are purchased. The QX actuator has the ability for diagnostics information to be downloaded to a PC or PDA via both IRDA and Bluetooth ports using the Dashboard software.

Valve and actuator position sensing

Valve position is sensed by an absolute encoder, employing system-on-chip technology which uses a contactless magnet that excites Hall-effect devices and provides 12-bit resolution over 360 degrees. Each of the position-sensing circuits contains a B.I.S.T. (built-in self-test) feature and is redundant, permitting up to 50 percent fault tolerance before the position

is incorrectly reported. The BIST feature discerns which failures will signal a warning only and which require a warning plus safe shutdown of the actuator. Open and closed positions are stored in permanent, nonvolatile memory. The encoder measures valve position at all times, including both motor and handwheel operation, with or without power present, and without the use of a battery. The absolute encoder is capable of resolving down to 0.1 percent of output shaft position over 360 degrees.

Valve and actuator torque sensing

The QX and MX are the only electric actuators that sense torque electronically. The QX senses torque electronically from motor current. The torque can be adjusted from 40 to 100 percent of rating in 1 percent increments, and the motor is deenergized if the torque limit is exceeded. A boost function is included to prevent torque trip during initial valve unseating and during extreme arctic temperature operation (from 0°C down to -60°C). The QX monitors for “jammed valve” as a protection feature and initiates an automatic retry sequence if no movement occurs.

Exterior corrosion protection

The QX actuator is coated with as standard a polymer powder coat suitable for exposure to an ASTM B117 salt spray test of 1,500 hours. External fasteners are 300 series stainless steel. Optional coatings are available by contacting factory.

Manual operation

A handwheel and declutch lever are provided for manual operation. The handwheel is an engineered resin material and changing from motor to manual operation is accomplished by engaging the declutch lever. Energizing the motor returns the QX to motor operation. The lever is padlockable in either motor or manual operation. Optional configurations for handwheels are available by consulting the factory.

Handwheel Ratio	Turns to Close 90°	Handwheel Diameter	Handwheel Efficiency
QX-1/QX-2 = 200:1	50	3'76 mm	26%
QX-3, QX-4, QX-5= 276:1	70	7.5'191 mm	26%

Factory testing

Every QX actuator is factory tested to verify rated output torque, output speed, handwheel operation, local control, control power supply, valve jammed function, all customer inputs and outputs, motor current, motor thermistor, LCD and LED operation, direction of rotation, microprocessor checks and position-sensor checks. A report confirming successful completion of testing is included with the actuator. Special testing can also be performed by contacting the factory.



Design life and endurance testing

- Design Life – 10,000 Open-to-Close cycles is considered typical life expectancy under normal operating conditions in approved ambient working environments.
- Endurance – 250,000 collective cycles of two 90-degree turns (0-90° Open, 90-0° Closed) were performed on the QX for proof of design.
- AWWA C540-02 – “Standard for Power Actuating Devices for Valves and Sluice Gates” – 10,000 cycles with confirmation of specified torque and position accuracy.

Options

Lost power buffer and 24 VDC UPS

Terminals are included and can be used to optionally connect the electronic controls package, including display, to a backup 24 VDC power source. Another option is the QX Quik. Once the actuator has been powered by line power for one hour, it can automatically withstand most power outages while maintaining the correct state of the alarm and status contacts, even if the user repositions the actuator manually with the handwheel. To maximize its self-power time while the line power is lost, the actuator will place itself in its lowest possible power usage mode. The LCD will darken (sleep mode) until it is needed to be viewed. The LCD can be activated by moving the black knob to OPEN (YES) or by moving the actuator with the handwheel. After 7-8 seconds of inactivity, the LCD will return to sleep mode. This feature can last up to three hours and automatically recharges once main power is restored.

The use of batteries to perform this function is not required.

Analog Position Transmitter (APT)

A non-contacting, internally powered, electrically isolated position transmitter can be included to provide a 4-20 mA or 0-10 VDC signal that is proportional to valve position.

Analog Torque Transmitter (ATT)

A non-contacting, internally powered, electrically isolated torque transmitter can be included to provide a 4-20 mA or 0-10 VDC signal that is proportional to rated output torque.

Voltages or Currents for APT/ATT	Maximum/Minimum External Load - APT/ATT
4-20 mA	470 ohms - 99.9% accuracy/ 750 ohms for 99% accuracy
0-10 VDC	1000 ohms minimum - 99.9% accuracy/ 2700 ohms minimum - 99% accuracy

Modutronic option

A controller that alters valve position in proportion to a 4-20 mA analog command signal can be ordered. Positioning is accomplished by comparing the command signal to a non-contacting internal position feedback. An automatic pulsing feature to prevent overshoot at the setpoint is included. Proportional bands, deadband, signal polarity, motion inhibits time, and fail are adjustable using either the Local control mode of configuration or MX/QX Dashboard. Deadband is adjustable to 0.5 percent full span for 9X and 0.3% for 9XM.

Voltages or Currents for Modulation	Input Impedance/Capacitance
4-20 mA	150 ohms Impedance

Relays for status and alarms

Up to eight additional latching output contacts rated 250 VAC/30 VDC, 5 A and configurable to represent any actuator status in either N/O or N/C state are available. Please refer to “Status and Alarm Contacts for Remote Indication” for list of settings.

“R” Contact and Monitor Relay AC Ratings	“S” Contact and Monitor Relay DC Ratings
5.0 Amps @ 250 VAC	5A @ 30 VDC (Resistive)

Custom software—Momentary contact ESD and partial stroke ESD

An optional, custom software is available which, when combined with the unique safety features of the QX actuator, permits a unique scope of performance for partial stroke and emergency shutdown installations.

When enabled a user may set up the partial stroke and ESD signals as redundant digital inputs for safety. There are two signal inputs for either selection, and both must be in the active state in order for the specific function to occur.

If the partial stroke enable inputs are not active, in a fault state, or are released by the control logic and a signal is detected on the momentary ESD/PSESD input, then the actuator will perform the configured ESD operation. The momentary ESD/PSESD input will be ignored if there is a signal present for less than 100 msec, and is guaranteed to latch in the ESD/PSESD if the signal is present for greater than 800 msec. ESD is active until the control logic ESD release is given.

Please contact factory for application and purchase.

Global Certifications

Non-hazardous (weatherproof / submersion) certifications IEC 529 protection code IP68; 20 meters for 168 hours USA & CSA; NEMA 3, 4, NEMA 4X, NEMA 6

Geographic Locations	Weatherproof/ Submersion	Standard Temperature	Optional Temperature
IEC 60529 Protection Code IP68	20M for 168 hours	-30°C to +70°C (-22°F to 156°F)	-50°C to +50°C (-58°F to 122°F)
USA & Canada, NEMA 3, 4, 6	20 ft. for 24 hours	-30°C to +70°C (-22°F to 156°F)	-50°C to +50°C (-58°F to 122°F)
USA & Canada, NEMA 4X	1500 hrs. to ASTM 176	-30°C to +70°C (-22°F to 156°F)	-50°C to +50°C (-58°F to 122°F)

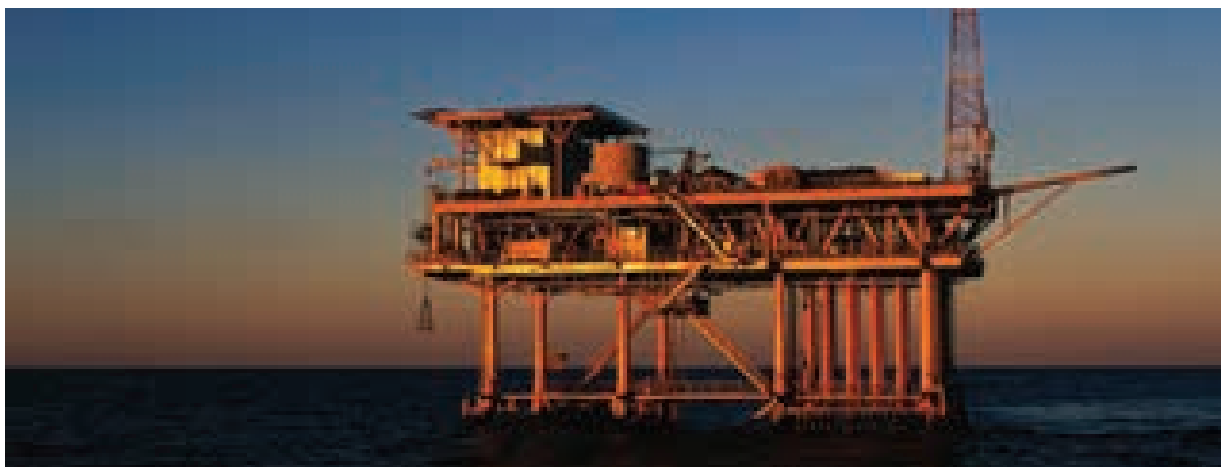

Standard hazardous global certifications

FM – Class I, Groups B, C & D, Div. 1 and Class II, Groups E, F and G, T6

T6 temperature classification is possible with operational times less than 15 min.

ATEX EExd IIB T6 ATEX II 2 G, CENELEC Norm EN50014 and EN50018

ATEX EExd IIC T6 ATEX II 2 G, CENELEC Norm EN50014 and EN50018

FM Canada – Class I, Groups B, C & D, Div. 1 and Class II, Groups E, F and G, T6

IEC - Exd IIB T6, IIB T6

IEC - Exd IIC T6, IIC T6

Geographic Locations	Explosionproof Classifications	Standard Temperature	Optional Temperature (2)
USA to Factory Mutual (FM)	Class I, Groups B, C, & D, Div. 1, T4 and Class II, Groups E, F, & G, Div. 2, T6	-30°C to +70°C (-22°F to 156°F)	-60°C to +40°C (-76°F to 104°F)
Canada to FM Canada	Class I, Groups B, C, & D, Div. 1, T4 and Class II, Groups E, F, & G, Div. 2, T6	-30°C to +70°C (-22°F to 156°F)	-50°C to +40°C (-76°F to 104°F)
ATEX II 2 G, CENELEC Norm EN 50014 & 50018	Eex d IIB T6, Eex d IIC T6, and Eex de IIB T6, Eex de IIC T6	-30°C to +70°C (-22°F to 156°F)	-60°C to +40°C (-76°F to 104°F) Eexd IIB T6 only
IEC	Eexd IIB T6, Eexd IIC T6, and Eexde IIB T6, Eexde IIC T6	-30°C to +70°C (-22°F to 156°F)	-60°C to +70°C (-76°F to +156°F), Eexd IIB T6 only

European directives

All QX actuator designs have been tested to demonstrate compatibility with the following European directives and are marked with the CE label:

- 2006/42/EC - Machinery Directive
- Vibration and seismic capability is in accordance with MILSTD-167, IEEE-344-1975, and IEC68-2-6. Test performed in each of three (3) axes, H1, horizontal – parallel to motor, H2, horizontal – perpendicular to motor, and “V1,” vertical.

Vibration Levels (QX functions after event)	Seismic Levels (QX functions after event)
5-100-5 Hz sweeps at 0.75g acceleration in 3 axes	5.0g acceleration from 3.5 – 31 - 3.5 Hz sine dwells in 3 axes
2-35-1 Hz sweeps at 1.0 g acceleration in 3 axes	3.0g acceleration from 35 - 200 Hz sine dwells in 3 axes
1-500-1 Hz sweeps @ 2.0 g acceleration in 3 axes	
25 Hz dwell @ 2.0 g acceleration in 3 axes	

- 2003/10/EC -Airborne Noise to EN 60204-1
The QX has been tested for noise emissions and at 1 m distance is less than 74 dB per grade A noise requirement of MIL-STD-740 and ANSI/ISA-S82.01-1994 (harmonized std. to IEC 1010-1).
- 2004/108/EC -EMC – Electromagnetic Compatibility and 93/68/EC -Low Voltage; EN 50081-1 & 2 – actuator complies with all pertinent requirements of Class A service categories in the listed table.



Applicable Emissions standards	EN55011:1998	Class A service	
Radiated emissions	EN55011:1998 & FCC Part 15, subpart J	30-130MHz 40dBmV / m 230-1000MHz 47dBmV / m	
Conducted emissions	EN55011:1998 & FCC Part 15, subpart J	0.15 to 0.5MHz 79dBmV (QuasiPeak 66dBmV avg) 0.5 to 30MHz 73dBmV (QuasiPeak 60dBmV avg)	
Applicable immunity standards	IEC EN 61000-6-1:2001		
ESD	IEC61000-4-1:1995	±8kV thru air ±4kV thru contact	
Radiated RF immunity	IEC61000-4-3:1995	80MHz to 2GHz 10Vrms / m	
Fast transients/burst	IEC61000-4-4:1995	EFT AC Power leads: ±2kV Signal leads: ±1kV	
Voltage surges	IEC61000-4-5:2001	AC Power: ±2kV com, ±1kV diff Signal leads: ±0.5V com, ±1kV diff	Perf criterion: B
Conducted RF immunity	IEC61000-4-6:1996	150kHz to 80MHz 10Vrms	Perf criterion: A w/ 80% AM modulation @ 1KHz
Magnetic field immunity	IEC61000-4-8:1993	Power line frequency 30A/m @ 60Hz	Perf criterion: A
Voltage dips and interrupts	IEC6326-1:2005 (IEC61000-4-11:2004)	60Hz 100% dip, 1 cycle duration 40% dip, 10 cycle duration 70% dip, 25 cycle duration 100% interrupt for 5s	Perf criterion: B, C 3 test each @ 10 sec interval 3 test each @ 10 sec interval 3 test each @ 10 sec interval 3 test each @ 10 sec interval

- Di-electric – Motor per NEMA MG1-12.02 and .03 with leakage of less than 10 mA. Control terminals per IEC-1131-2 and CSA C22.2 with check against physical breakdown.



FCD LMENBR3302-02 0611 Printed in USA.

To find your local Flowserve representative:

For more information about Flowserve Corporation, visit www.flowserve.com or www.limatorque.com, or call USA 1 800 225 6989

Flowserve Corporation has established industry leadership in the design and manufacture of its products. When properly selected, this Flowserve product is designed to perform its intended function safely during its useful life. However, the purchaser or user of Flowserve products should be aware that Flowserve products might be used in numerous applications under a wide variety of industrial service conditions. Although Flowserve can (and often does) provide general guidelines, it cannot provide specific data and warnings for all possible applications. The purchaser/user must therefore assume the ultimate responsibility for the proper sizing and selection, installation, operation, and maintenance of Flowserve products. The purchaser/user should read and understand the Installation Operation Maintenance (IOM) instructions included with the product, and train its employees and contractors in the safe use of Flowserve products in connection with the specific application.

While the information and specifications contained in this literature are believed to be accurate, they are supplied for informative purposes only and should not be considered certified or as a guarantee of satisfactory results by reliance thereon. Nothing contained herein is to be construed as a warranty or guarantee, express or implied, regarding any matter with respect to this product. Because Flowserve is continually improving and upgrading its product design, the specifications, dimensions and information contained herein are subject to change without notice. Should any question arise concerning these provisions, the purchaser/user should contact Flowserve Corporation at any one of its worldwide operations or offices.

© 2011 Flowserve Corporation, Irving, Texas, USA. Flowserve is a registered trademark of Flowserve Corporation.

**Flowserve Corporation
Flow Control**

United States

Flowserve Limatorque
5114 Woodall Road
P.O. Box 11318
Lynchburg, VA 24506-1318
Phone: 434-528-4400
Facsimile: 434-845-9736

England

Flowserve Limatorque
Euro House
Abex Road
Newbury
Berkshire, RG14 5EY
United Kingdom
Phone: 44-1-635-46999
Facsimile: 44-1-635-36034

Japan

Limatorque – Nippon Gear Co., Ltd.
NOF Bldg. 9th Floor
1-11-11, Kita-Saiwai, Nishi-Ku
Yokohama (220-0004)
Japan
Phone: 81-45-326-2065
Facsimile: 81-45-320-5962

Singapore

Flowserve Limatorque
12, Tuas Avenue 20
Singapore 638824
Phone: 65-6868-4628
Facsimile: 65-6862-4940

China

Limatorque Beijing, Pte., Ltd.
RM A1/A2
22/F, East Area, Hanwei Plaza
No. 7 Guanghua Road, Chaoyang District
Beijing 100004, Peoples Republic of China
Phone: 86-10-5921-0606
Facsimile: 86-10-6561-2702

India

Flowserve Limatorque, Ltd.
Plot No 4
Export Promotional Industrial Park
Whitefield, Bangalore 560066
India
Phone: 91-80-40146200
Facsimile: 91-80-28410286