

Micro Motion[®] Corrosion Guide

For Coriolis Flow and Density Meters, Density Meters, and
Viscosity Meters

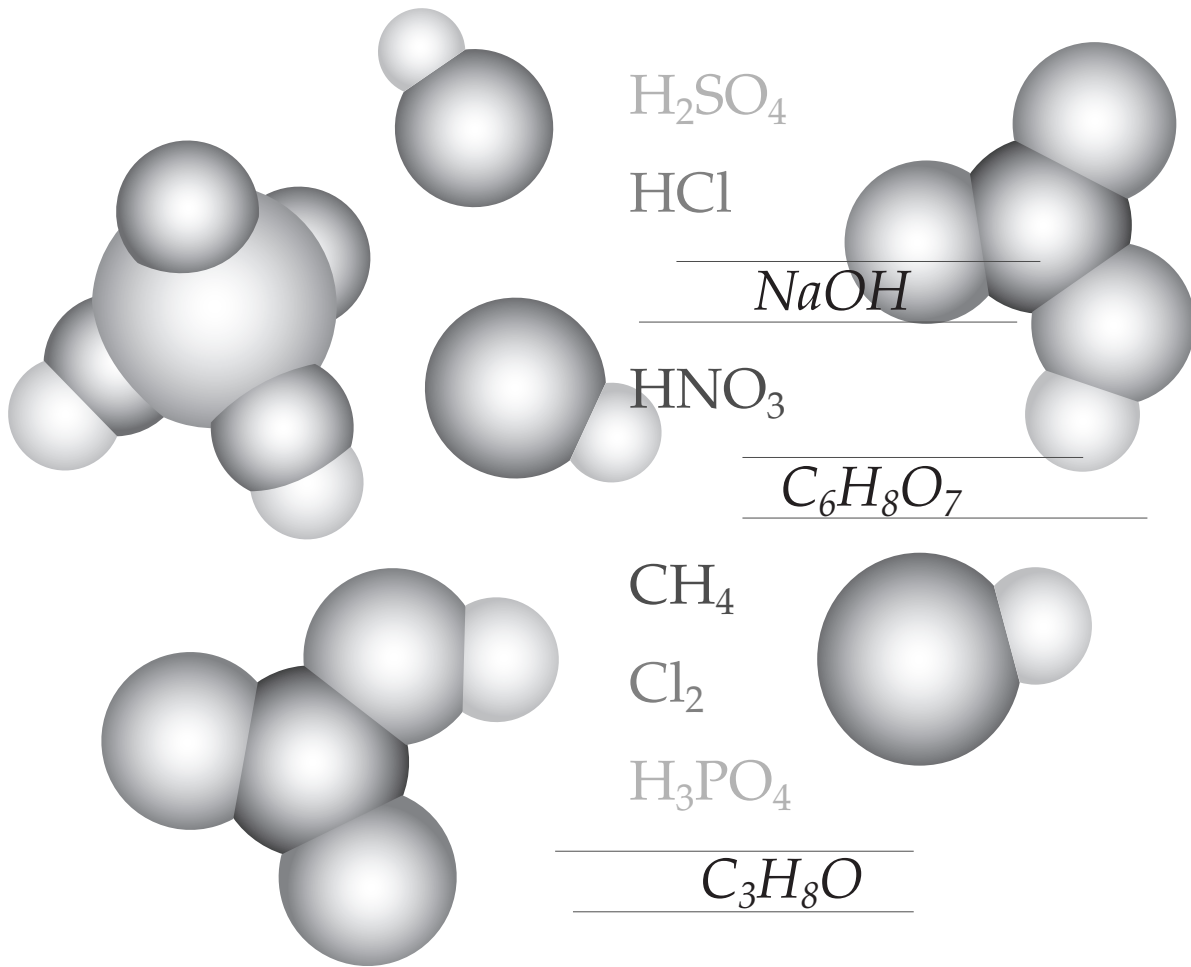

Disclaimer: The guidelines in this publication are provided for informational purposes only. Minor changes in fluid properties (e.g., temperature, concentration, impurity levels) can affect the compatibility of wetted parts. Material compatibility choices are solely the responsibility of the end user.

© 2014 Micro Motion, Inc. All rights reserved.

The Emerson logo is a trademark and service mark of Emerson Electric Co. Micro Motion, ELITE, ProLink, MVD and MVD Direct Connect are marks of one of the Emerson Process Management family of companies. All other trademarks are property of their respective owners.

Contents

Coriolis flow and density meters	1
Policy for mixed material bi-metallic meter compatibility.	6
How to use the material compatibility table for Coriolis meters	9
Material compatibility table for Coriolis meters	10
Application notes.	32
Density and viscosity meters	36
How to use the material compatibility table for Density and viscosity meters.	38
Material compatibility table for tube density meters.	39
Material compatibility table for fork density meters, viscosity meters	62
Synonyms	90

Coriolis flow and density meters

Coriolis mass flow and density meters are a major advance in flow measurement. These devices have set a precedent for accuracy and repeatability under a wide variety of flow conditions. The inherent precision has established it as a standard for numerous industrial applications. The ability of these meters to measure mass flow and density directly has led to their use in applications ranging from metering food products to corrosive chemicals. Coriolis meters have proven extremely reliable when metering noncorrosive fluids. The same reliability can be achieved in corrosive services if consideration is given to the compatibility of the process fluid with the sensor materials of construction.

To satisfy the need of selecting the right material for a given application, Micro Motion manufactures meters in 316L, 304L, and super duplex stainless steels, 316L stainless steel lined with Tefzel® coating, nickel alloy C22, titanium, and tantalum.

Material compatibility

Material compatibility must be considered in more detail for Coriolis meters as compared to pressure-containing pipe. Compatibility in the latter case is usually addressed by consulting a general corrosion guide. General corrosion is a term that refers to the uniform loss of material. The rate of material removal is usually expressed in terms of inches or millimeters lost per year. These rates are determined experimentally by exposing a sample to the environment for a specific time period. Weight loss or dimensional changes are then used to determine the corrosion rate.

General corrosion tests are insensitive to detection of localized corrosion and are not always adequate for determining material compatibility for Coriolis meters. Pitting, intergranular attack, stress corrosion cracking, and corrosion fatigue are all forms of localized corrosion that can lead to meter failure.

Localized corrosion of the flow tube can initiate fatigue cracking. Meter failure can then occur due to the rapid rate at which fatigue cracks propagate. The approach to preventing meter failure is to avoid the onset of fatigue cracks. For this reason, the possibility of localized corrosive attack must be considered when selecting wetted materials.

Coriolis flow and density meters *continued*

Material compatibility cannot always be assessed by considering the alloy(s) selected for the remainder of the piping system. Material compatibility for most piping systems is based upon general corrosion rates alone and does not account for localized corrosion or cyclic loading. Coriolis meters require vibration of one or two flow tubes to make a mass flow or density measurement. The cyclic loading condition is inherent to all Coriolis meters and must be considered in the material selection process.

Material compatibility variables

The numerous environments in which the meter can be used make it difficult to define process fluid compatibility for every possible material combination. The difference in chemical composition of most environments can be characterized by four variables. These are halogen concentration, pH, chemical potential, and temperature. If these variables can be defined for a particular environment, comparisons of alloy limitations can be made and a compatible material of construction chosen. Figures 1 through 4 show the domain of acceptable performance for 316L stainless steel, nickel alloy C22, titanium, and tantalum as a function of the first three variables. The effect of temperature on meter life can be characterized by considering its effect on the other three variables.

Halogens

The term *halogen* refers to a specific group of elements and includes chlorine, fluorine, bromine, and iodine. The most common halogen is chlorine. The presence of the ionic form, Cl^- , even as a contaminant, can be extremely detrimental to corrosion resistance. Stainless steels are particularly susceptible. Meters constructed of 316L stainless steel have been extremely reliable in numerous applications where chloride concentrations can be maintained at sufficiently low levels or where free chlorides are absent (see

Figure 1). Stainless steel can also be used in organic solutions that contain a chloride component, provided ion formation is avoided. Two factors that influence dissociation are temperature and moisture. Both need to be kept low to avoid failure. Figure 2 shows that the resistance of 316L to free chloride-induced corrosion fatigue is temperature dependent. Low combinations of temperature and chloride concentration are compatible with 316L stainless steel. Pitting and corrosion fatigue are possible for higher combinations of temperature and chloride concentrations. Nickel alloy C22 should be used when these conditions exist. If the chloride content is increased further and pH lowered, nickel alloy C22 may also succumb to localized attack and corrosion fatigue.

pH

The pH of a solution can also alter the corrosion behavior of any given alloy. In general, solutions that have a neutral pH (near 7) tend to be less aggressive than strongly acidic ($\text{pH} < 3$) or strongly alkaline ($\text{pH} > 11$) solutions (see Figure 3). Tantalum, for example, has superior corrosion resistance to 316L stainless steel and nickel alloy C22 in neutral and acidic environments. However, high corrosion rates will occur if tantalum is used in caustic applications such as sodium hydroxide, even at room temperature. At higher temperatures, stress corrosion cracking and corrosion fatigue are possible. Under these conditions, nickel alloy C22 is recommended. Nickel alloy C22 should be used in all caustic applications in which there is a possibility of chloride contamination.

Coriolis flow and density meters *continued*

Chemical potential

The chemical potential is a measure of the oxidizing or reducing power of a process fluid. Chemical potential, sometimes referred to as *redox* potential, is defined relative to the $H_2 \rightarrow 2H^+ + 2e^-$ half reaction, which is assigned a value of zero volts. Any environment that has a chemical potential greater than the reference is considered oxidizing. Chemical potentials that are equal to or less than the reference are considered reducing. Chemical potential is important because a minimum amount of oxidizing power is required to enable the formation of protective surface oxide layers. Optimal life will be realized as long as this layer is stable. Environments that are too oxidizing or reducing will prevent stable oxide formation. Under such conditions, failure due to corrosion fatigue or erosion/corrosion is possible.

The corrosion fatigue resistance of a material of construction is related to the range of chemical potentials over which oxide layer stability is maintained. The broader the range in Figure 4, the more environments in which the material will resist corrosion.

Tantalum pentoxide (Ta_2O_5) is stable on the surface of metallic tantalum at extremely low reducing potentials. This oxide also resists breakdown in all but the most oxidizing environments.

The wide range of chemical potentials over which passivity is maintained make tantalum resistant to most corrosive fluids. The second most stable oxide forms on the surface of nickel-based alloys such as nickel alloy C22. A high chromium and molybdenum content stabilizes the oxide layer, yielding improved performance over 316L stainless steel in chloride bearing applications. 316L stainless steel exhibits passivity over a narrow range, as compared to the other two materials. However, 316L stainless steel has proven to be suitable for a large number of chemical processing applications.

Figure 1. Typical chloride concentration range for meter materials

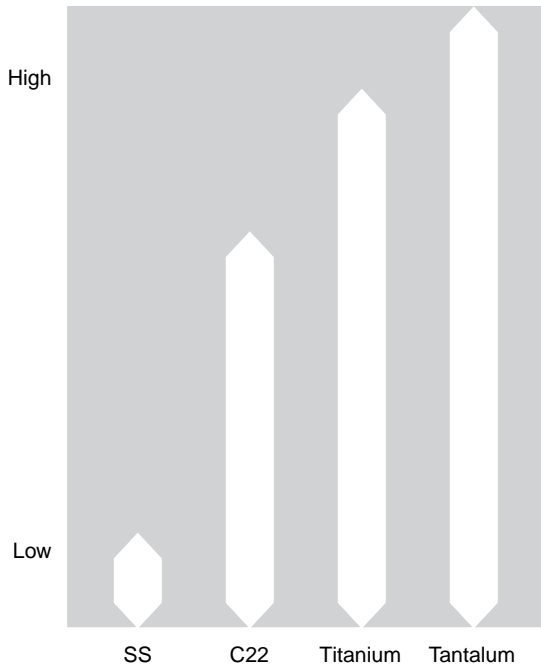

Figure 2. Chloride ion concentrations and temperature limits for 316L

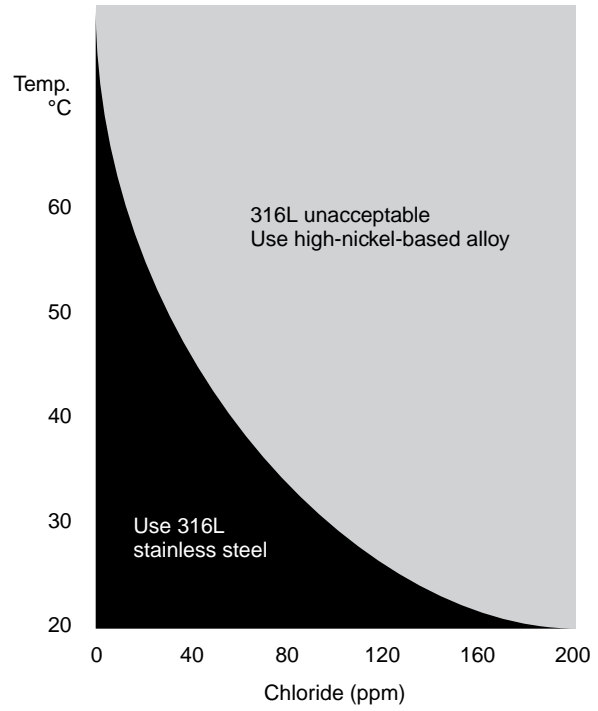

Figure 3. Typical pH range for meter material

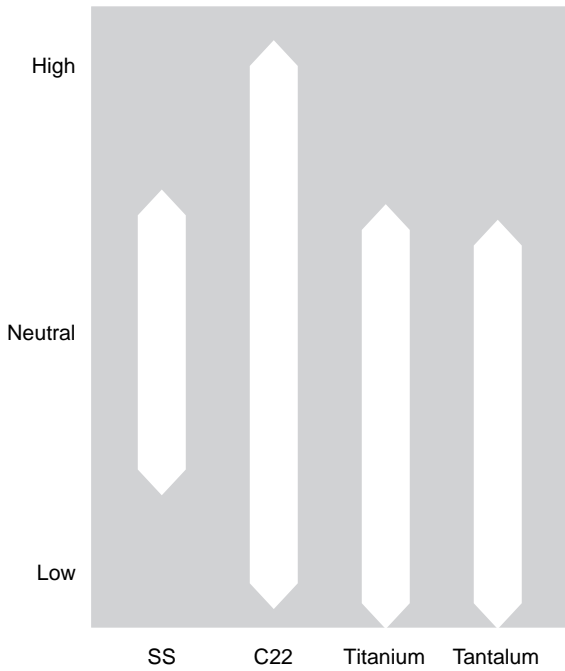
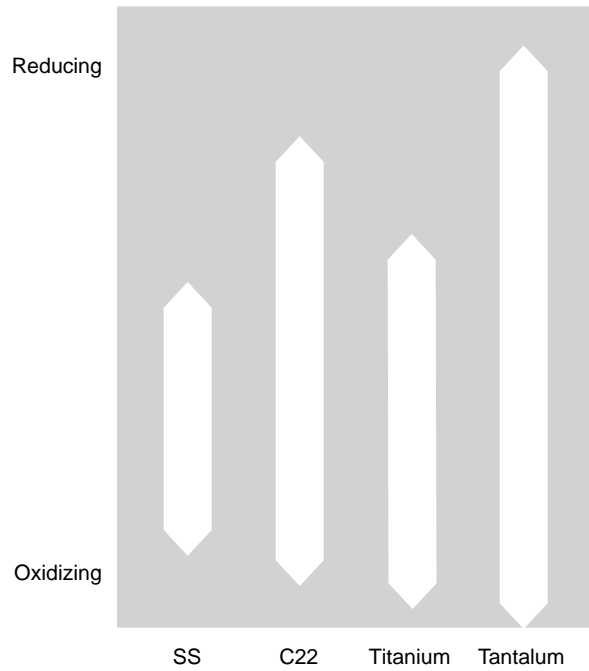

Figure 4. Chemical potential range for meter materials



Coriolis flow and density meters *continued*

Tefzel®

Experience suggests that some applications are aggressive to all metallic components. Process fluids containing fluorine will rapidly corrode any metal. For example, hydrofluoric acid can be a contaminant in low quality grades of hydrochloric acid. Meters employing metallic materials of construction, including 316L stainless steel, nickel alloy C22, and tantalum, will have short lives in aqueous fluorine applications. Premature meter failure can often be avoided by checking the process stream for this component. If low concentrations are unavoidable, a Coriolis meter lined with Tefzel can be used. Tefzel is very similar to Teflon® in both physical properties and corrosion resistance. The Tefzel lining acts as a barrier, which prevents the process fluid from coming in contact with the underlying metal and causing corrosion cracking. Tefzel is not, however, a universally corrosion-resistant material. Tefzel is embrittled by strong acids and strong bases. Certain organic solvents and temperatures can influence the mechanical strength of Tefzel. For this reason Tefzel-lined instruments are limited to applications where the temperature is less than 248 °F (120 °C). Because the Tefzel lining and the 316L stainless steel flow tubes have different coefficients of thermal expansion, special temperature considerations apply. Tefzel-lined meters have a maximum allowable rate of meter temperature change equal to 30 °F/hr (17 °C/h).

Super duplex

For high capacity applications, super duplex stainless steel is a possible option when a 316L stainless meter is not compatible. Super duplex combines higher strength and better chloride corrosion resistance than 316L, expanding the range for large meters into more demanding conditions. Higher strength allows use at higher operating pressures, and better chloride resistance allows use with higher chloride contents at higher process temperatures.

The oil & gas industry uses super duplex stainless steel in moderate temperature applications containing levels of chlorides and CO₂ too high for 316L stainless. However, sour conditions with elemental sulfur or a H₂S partial pressure over 3 psia can cause corrosion problems.

Consideration of the total process environment is an important step in selecting the best materials of construction. For recommendations, contact Micro Motion with complete process conditions, including fluid temperature, pressure, bubble point, pH, and amounts of chlorides, oxygen, H₂S, CO₂, bicarbonates, water and elemental sulfur.

The wetted components of a super duplex meter that contact the process fluid are made from alloys 2507 and CE3MN (2507 equivalent). Both alloys have a two-phase structure of austenite and ferrite, which is the source of the duplex name. Due to the ferrite content of super duplex, cryogenic applications should be avoided.

Summary

To help the customer select the right material for a given application, Micro Motion manufactures Coriolis meters in 316L, 304L, and super duplex stainless steels, nickel alloy C22, tantalum, titanium, and 316L lined with Tefzel. Experience indicates 316L is a good general purpose material suitable for many applications. In situations where more corrosive process fluids need to be measured, or when chlorine is present, nickel alloy C22 is often the material of choice. Tantalum is available for extreme conditions involving combinations of high temperature, low pH, or very high chloride concentrations. These materials are not recommended for service in aqueous fluorine environments. A nonmetallic liner, such as Tefzel, is required under such conditions.

Policy for mixed material bi-metallic meter compatibility

Policy

It is the policy of Micro Motion, Inc. when applying a mixed material, bi-metallic meter, the Corrosion Guide recommendations for the less corrosion resistant material of the two shall be used.

Summary

The intent of this policy statement is to provide guidance regarding the application of bi-metallic meters. Examples include the CMF400P, DT meters, and any meter that uses a process connection made of a different material than the remainder of the meter. In addition, this document can be used to gain clarification into the most common applications for these meters. The policy is: To properly apply meters manufactured with bi-metallic materials, use the Micro Motion Inc. Corrosion Guide for the less corrosion resistant material. This usually is 316L, listed as SS in the guide.

Parts of the meter

The meter is comprised of three main components which contact the process fluid, known as wetted components. These components are the tubes, the manifolds, and the process connections. Figure 5 is a CMF400P with C22 tubes for a higher pressure rating. The manifolds and process connections are SS. The DT series for use at elevated temperatures also have C22 tubes for a higher pressure rating. Figure 6 is a CMF010P with C22 tubes for a higher pressure rating. The tube ports and process connections are SS.

Materials

For bi-metallic meters, the three components mentioned above can be constructed of either stainless steel, such as 316L, or a nickel-chromium-molybdenum alloy, such as nickel alloy C22 (UNS N06022). The tubing and process connections are constructed of either 316L or nickel alloy C22. The manifolds are either CF-3M (316L equivalent) or CW-2M (nickel-chromium-molybdenum equivalent) castings. In this document, the stainless steel components are referred to as "SS" and the nickel-chromium-molybdenum alloys are referred to as "C22." 316L is a common stainless steel alloy and has good corrosion resistance to a wide variety of process fluids. C22 is more resistant to Chloride-induced Stress Corrosion Cracking (CSCC).

Reasons for mixture

In general, bi-metallic meters are used for high pressure applications. Some examples are Models CMF010P and DT150H, which have a higher strength C22 tube for a higher pressure rating, and which are to be used only in less aggressive environments that are compatible with the SS manifolds and process connections.

Another example is the Model CMF400P, which might have a 900# SS process connection for a higher pressure rating. Again, this option can be used only for environments compatible with SS.

For most applications, C22 has better corrosion resistance than SS. One exception is nitric acid, for which 304 stainless steel has better corrosion resistance.

Policy for mixed material bi-metallic meter compatibility *continued*

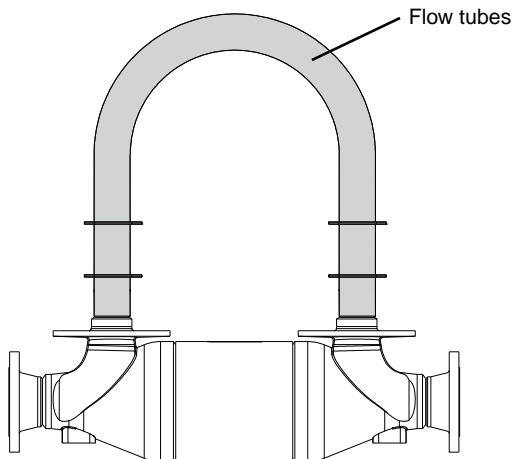

Figure 5. CMF400 with flow tubes highlighted

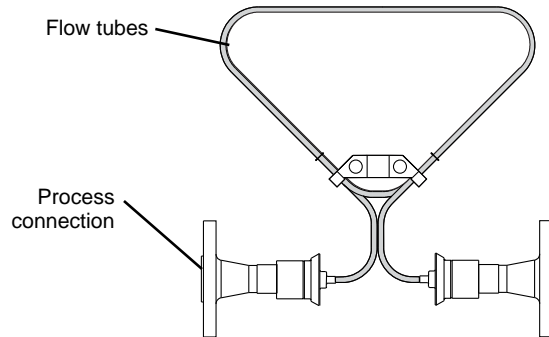

Figure 6. CMF010 tubes and process connections

Material compatibility

In general, a meter manufactured out of bi-metallic materials will effectively have the corrosion resistance of the less corrosion resistant material. In most applications the less corrosion resistant material will be SS.

Common applications for mixed material meters

The following list was compiled in conjunction with the marketing and applications groups. It is not intended to be an exclusive list, simply a listing of expected applications. For each fluid there is a brief description of the pertinent compatibility information.

Policy for mixed material bi-metallic meter compatibility *continued*

1. Condensate and crude oil

Petroleum condensates and crude oils are not corrosive at temperatures below that at which hydrocarbons crack (that occurs during refining at very high temperatures). H₂S contained in these hydrocarbons does not attack steel (< 500 °F [260 °C]), as long as water is not present. For 316L and nickel alloy C22, corrosion from H₂S in the absence of water does not occur until temperatures exceed 900 °F (480 °C).

However, when water is present, corrosion, pitting, and stress corrosion cracking (SCC) of 316L is a function of many variables. The primary variables are: pH, chloride content, water cut, H₂S and CO₂ content, dissolved oxygen content, pressure and temperature. These factors are discussed in the section on produced water.

2. Methane, ethane, propane and ethylene

These hydrocarbons are non-corrosive to stainless steels and nickel alloys. Thus SS and C22 can be used in any of these hydrocarbons without concern for corrosion. Even if water is present (as condensed fresh water) there is no corrosion concern.

3. Pure elemental gases (hydrogen, nitrogen, argon)

These gases are non-corrosive to stainless steels and nickel alloys. Thus SS and C22 can be used in these gasses up to the temperature limits of the meter.

4. Natural gas (liquid natural gas [LNG], liquid petroleum gas [LPG])

Natural gas in both the gaseous or liquid state and LPG are non-corrosive. One possible concern with CF-3M at LNG temperatures would be the fracture toughness. Since CF-3M contains up to ~30% ferrite the fracture toughness at -260 °F (-160 °C) (i.e., LNG temperatures) may not be adequate. C22 will have excellent low temperature impact toughness for LNG applications.

5. Produced water

There are numerous possible compositions of produced water (water that is produced with oil and gas). The composition depends on the reservoir conditions, the formation water chemistry, and the amount of H₂S and CO₂ in the reservoir. Moreover, these conditions may change over time if the field is water flooded, and/or flooded with CO₂, or other enhanced oil recovery methods are applied.

In the complete absence of oxygen, the limits of 316L are a function of chlorides, H₂S, pH and temperature. In the absence of H₂S, 316L can be used in produced water with chloride contents < 50,000 ppm and pH > 4.5 up to 140 °F (60 °C). When H₂S is present, ANSI/NACE MR0175/ISO 15156 effectively limits the use of 316L to 140 °F for all chlorides at H₂S partial pressures up to 15 psia and 140 °F (60 °C) for H₂S partial pressures > 15 psia (1 bar) but ≤ 50 psia (3.5 bar) and 50 ppm maximum chlorides.

For current oil field operations (< 400 °F) there are no restrictions or limits to the application of nickel alloy C22, even in the presence of H₂S.

In the presence of oxygen dissolved in the water phase, 316L is limited to a critical pitting temperature of about 70 °F, above which pitting occurs. C22 has a critical pitting temperature of about 150 °F.

Policy for mixed material bi-metallic meter compatibility *continued*

6. Process Water

As with produced water, there are multiple possible compositions for process water. Process water can be sea water with a high chloride content, or from the city tap with a low chloride content, or from distilled water without chlorides.

Recommendation

For bi-metallic meters, use the Micro Motion Inc. Corrosion Guide for the less corrosion resistant material, which is normally SS. All CMF400P orders are referred to the Metallurgy Department for approval on alloy selection.

How to use the material compatibility table for Coriolis meters

The material compatibility table for Coriolis meters begins on page 10. The information on this page is provided to assist in the interpretation of the table.

Fluids

Fluids are listed alphabetically and are generally listed under the appropriate chemical names, not trade names. The synonyms section on page 92 provides a means to cross-reference trade names and other commonly-used names in this corrosion guide. All fluids and flow conditions must be considered when making material selections. This includes the primary fluid, contaminants, cleaning, and/or other chemical solutions.

Temperature and concentration

Each chemical may have one or more temperature and concentration combinations that define the environment to which the particular material was subjected. Temperature variation must be taken into account. In general, lower temperatures reduce the possibility of localized attack. This rule does not necessarily apply for variations in concentration. It is equally possible for a low or high concentration to cause corrosion. Evaporation of a fluid can result in elevated concentration of components, which can lead to corrosion. This situation can be avoided by

keeping the meter full at all times. If the meter must be emptied, care must be taken to completely flush the meter of any residual corrosive.

Materials

Compatibility of 316L stainless steel, nickel alloy C22, Tefzel, tantalum, and titanium are displayed in the material compatibility columns. To simplify interpretation, only four symbols have been used:

- X The selected material is not compatible with the environment
- O The selected material is compatible with the environment
- No data available
- C Conflicting data

Note:

Corrosion data is not always available for the full temperature range of the meter. Materials will normally maintain corrosion resistance at temperatures below the lower limits in the table. Contact Micro Motion if your process might exceed the maximum temperature limits listed in the table for a particular application. Where temperature ranges have been omitted from the table, corrosion resistance is believed to be maintained throughout the temperature range of the meter. For applications that do not appear in this corrosion guide, please contact Micro Motion.

Material compatibility for Coriolis meters

Fluid name	Temp. (°C)		Conc. (%wt)		Material compatibility					Notes
	Low	High	Low	High	SS	C22	TZ	TA	TI	
Acetaldehyde	-18	93	0	100	O	O	O	X	O	
Acetaldehyde	93	149	0	100	-	-	-	-	O	
Acetate	-18	52	0	100	O	O	O	-	O	
Acetate	52	77	0	100	O	O	-	-	O	
Acetate	77	100	0	100	O	O	X	-	O	
Acetate	100	204	0	100	O	O	X	-	O	
Acetic Acid	-18	10	0	50	O	O	C	O	O	
Acetic Acid	-18	10	50	80	O	O	X	O	O	
Acetic Acid	-18	10	80	95	-	O	X	O	O	
Acetic Acid	-18	10	95	100	O	O	O	O	O	
Acetic Acid	10	71	0	50	O	O	C	O	O	
Acetic Acid	10	71	50	80	O	O	X	O	O	
Acetic Acid	10	71	80	95	X	O	X	O	O	
Acetic Acid	10	66	95	100	O	O	O	O	O	
Acetic Acid	66	93	95	100	O	O	-	O	O	
Acetic Acid	71	79	0	45	O	O	X	O	O	
Acetic Acid	71	79	45	50	C	O	X	O	O	
Acetic Acid	71	79	50	80	-	O	X	O	O	
Acetic Acid	79	93	0	45	O	O	X	O	O	
Acetic Acid	79	93	45	50	C	O	X	O	O	
Acetic Acid	79	93	50	55	-	O	X	O	O	
Acetic Acid	79	93	55	95	X	O	X	O	O	
Acetic Acid	93	99	0	20	O	O	X	O	O	
Acetic Acid	93	99	20	50	C	O	X	O	O	
Acetic Acid	93	99	50	55	-	O	X	O	O	
Acetic Acid	93	99	55	80	X	O	X	O	O	
Acetic Acid	93	99	80	95	X	X	X	O	-	
Acetic Acid	93	118	95	100	X	O	-	O	X	
Acetic Acid	99	104	0	20	O	O	X	O	O	
Acetic Acid	99	104	20	50	C	X	X	O	O	
Acetic Acid	99	104	50	55	-	X	X	O	O	
Acetic Acid	99	104	55	80	X	X	X	O	O	
Acetic Acid	99	104	80	95	X	X	X	O	-	
Acetic Acid	104	127	0	20	O	O	X	O	O	
Acetic Acid	104	127	20	50	C	X	X	O	O	
Acetic Acid	104	127	50	55	-	X	X	O	O	
Acetic Acid	104	127	50	80	X	X	X	O	O	
Acetic Acid	104	127	80	85	X	X	X	O	-	
Acetic Acid	104	127	85	95	X	X	X	O	X	
Acetic Acid	118	204	95	100	X	O	X	O	X	
Acetic Acid	127	135	0	20	O	O	X	O	-	

SS = Stainless steel
C22 = Nickel alloy C22

TZ = Tefzel-lined 316L
TA = Tantalum
TI = Titanium

See page 9 for material compatibility codes.

Material compatibility for Coriolis meters *continued*

Fluid name	Temp. (°C)		Conc. (%wt)		Material compatibility					Notes
	Low	High	Low	High	SS	C22	TZ	TA	TI	
Acetic Acid	127	135	20	50	C	X	X	O	–	
Acetic Acid	127	135	50	55	–	X	X	O	–	
Acetic Acid	127	135	50	85	X	X	X	O	–	
Acetic Acid	127	135	85	95	X	X	X	O	X	
Acetic Acid	135	149	0	20	O	O	X	O	X	
Acetic Acid	135	149	20	50	C	X	X	O	X	
Acetic Acid	135	149	50	55	–	X	X	O	X	
Acetic Acid	135	149	55	95	X	X	X	O	X	
Acetic Acid	149	204	0	20	O	–	X	O	X	
Acetic Acid	149	204	20	50	C	X	X	O	X	
Acetic Acid	149	204	50	55	–	X	X	O	X	
Acetic Acid	149	204	55	95	X	X	X	O	X	
Acetic Anhydride	–18	38	0	100	X	O	O	O	O	
Acetic Anhydride	38	121	0	100	X	O	O	X	O	
Acetic Anhydride	121	143	0	100	X	O	X	X	O	
Acetone	–18	60	0	100	O	O	O	O	O	
Acetone	60	93	0	100	O	O	X	O	O	
Acetone	93	104	0	100	O	O	X	O	–	
Acetone	104	149	0	100	O	–	X	O	–	
Acetone	149	204	0	100	O	–	X	–	–	
Acetone Cyanhydrin					O	–	–	O	–	
Acetone, 50% Water	–18	60	0	100	X	O	O	O	O	
Acetone, 50% Water	60	104	0	100	X	O	–	O	O	
Acetonitrile	0	60	0	100	O	–	O	O	–	
Acetyl Chloride	–18	21	0	100	O	O	O	O	–	
Acetyl Chloride	21	37	0	100	X	O	O	–	–	
Acetyl Chloride	37	60	0	100	X	–	O	–	–	
Acetylene	0	26	0	100	O	O	O	O	O	
Acetylene	26	37	0	100	O	O	O	–	–	
Acetylene	37	116	0	100	O	–	O	–	–	
Acetylene	116	204	0	100	O	–	–	–	–	
Acetylene Tetrabromide					X	–	O	O	–	
Acetylene Trichloride	0	106	0	90	X	O	O	O	–	
Acid Pulping	0	80	0	100	X	O	O	O	–	
Acrylic Acid	0	53			O	O	–	–	–	
Acrylic Emulsion					O	O	O	O	–	
Acrylonitrile	0	60	0	100	O	O	O	O	O	
Acrylonitrile	60	87	0	100	O	O	–	O	O	
Acrylonitrile	87	104	0	100	X	O	–	O	X	
Acrylonitrile	104	130	0	100	–	–	–	O	X	

SS = Stainless steel
C22 = Nickel alloy C22

TZ = Tefzel-lined 316L
TA = Tantalum
TI = Titanium

See page 9 for material compatibility codes.

Material compatibility for Coriolis meters *continued*

Fluid name	Temp. (°C)		Conc. (%wt)		Material compatibility					Notes
	Low	High	Low	High	SS	C22	TZ	TA	TI	
Adipic Acid	0	10	0	100	O	O	O	O	O	
Adipic Acid	10	93	0	100	O	O	O	X	O	
Adipic Acid	93	120	0	100	X	-	O	X	O	
Adipic Acid	120	220	0	100	X	-	-	-	O	
Air					O	O	O	O	O	
Alachlor Technical					-	O	-	O	-	Chlorodiethylacetanilide
Alcohols	0	100	0	100	O	O	O	O	C	
Alkaline Liquor					O	O	O	X	-	
Alkylbenzene Sulfonic Acid					-	O	-	O	-	
Alkyldimethyl Ammonium Chloride					X	O	O	O	-	
Allyl Alcohol	0	93	0	100	O	O	O	X	X	
Allyl Alcohol	93	209	0	100	O	X	-	-	-	
Allyl Chloride	0	26	0	100	O	O	O	-	O	
Allyl Chloride	26	82	0	100	X	X	O	-	O	
Allyl Chloride Phenol					X	O	O	O	O	
Allyl Chloroformate					X	O	-	O	-	
Allyl Phenol	0	130	0	100	O	-	X	-	-	
Allylbenzene	20	60	0	100	O	-	-	-	-	
Alphamethylstyrene					O	O	O	O	-	
Alum	0	30	0	100	O	O	O	X	O	
Alum	30	98	0	100	-	X	O	-	O	
Alum	98	120	0	100	-	-	O	-	-	
Alumina					O	O	O	O	O	
Aluminum Chloride Aqueous	0	93	0	10	X	O	O	O	O	
Aluminum Chloride Aqueous	0	93	10	100	X	O	O	O	X	
Aluminum Chloride Aqueous	93	120	0	100	X	-	O	-	X	
Aluminum Chloride Dry	0	93	0	100	X	O	O	O	X	
Aluminum Chloride Dry	93	120	0	100	X	-	O	O	-	
Aluminum Chlorohydroxide					X	O	O	O	-	
Aluminum Fluorosulfate	0	200	0	15	-	O	-	O	-	
Aluminum Nitrate	0	98	0	100	O	-	O	O	O	
Aluminum Nitrate	98	120	0	100	X	-	O	O	-	
Aluminum Oxide					O	O	O	-	-	
Aluminum Silicate					-	-	-	-	-	
Aluminum Sulfate	0	38	0	100	X	O	O	O	O	
Aluminum Sulfate	38	93	0	100	X	-	X	O	O	
Amine	0	100	0	100	O	O	-	O	O	
Amine	100	120	0	100	X	X	O	O	-	
Amine	120	148	0	100	-	-	X	O	-	
Ammonia	0	30	0	50	O	O	O	O	O	

SS = Stainless steel
C22 = Nickel alloy C22

TZ = Tefzel-lined 316L
TA = Tantalum
TI = Titanium

See page 9 for material compatibility codes.

Material compatibility for Coriolis meters *continued*

Fluid name	Temp. (°C)		Conc. (%wt)		Material compatibility					Notes
	Low	High	Low	High	SS	C22	TZ	TA	TI	
Ammonia	30	70	0	30	O	O	O	X	X	
Ammonia	30	70	30	50	X	O	O	X	X	
Ammonia	70	150	0	50	X	O	X	X	X	
Ammonia Anhydrous					O	O	O	X	X	
Ammonium Carbonate	0	20	0	30	O	O	O	O	O	
Ammonium Carbonate	20	93	0	30	O	X	O	O	O	
Ammonium Carbonate	93	120	0	30	X	-	O	-	-	
Ammonium Chloride	0	93	0	10	X	O	O	O	O	
Ammonium Chloride	0	82	0	50	X	O	O	O	O	
Ammonium Chloride	82	104	0	50	X	-	O	O	O	
Ammonium Chloride	104	120	0	50	X	-	O	-	-	
Ammonium Dihydrozene Phosphate					-	O	-	O	-	
Ammonium Laurate					O	-	-	-	-	
Ammonium Laureth Sulfate					-	O	-	O	-	
Ammonium Nitrate	0	93	0	100	O	O	O	O	O	304LO
Ammonium Nitrate	93	120	0	100	O	C	O	-	-	304LO
Ammonium Oxalate	0	24	0	10	X	O	-	O	-	
Ammonium Persulfate	0	25	0	5	O	O	O	O	O	
Ammonium Persulfate	0	25	5	10	O	O	O	-	O	
Ammonium Persulfate	0	60	10	100	O	-	O	-	O	
Ammonium Persulfate	60	120	10	100	-	-	O	-	-	
Ammonium Phosphate	0	60	0	10	O	O	O	O	O	
Ammonium Phosphate	0	60	10	100	X	O	O	O	O	
Ammonium Phosphate	60	104	0	10	X	X	O	O	O	
Ammonium Phosphate	60	120	10	100	-	-	O	O	-	
Ammonium Phosphate	104	120	0	10	-	-	O	O	O	
Ammonium Phosphate	120	148	10	100	-	-	-	O	-	
Ammonium Saltwater	20	80	0	15	X	O	O	X	-	
Ammonium Sulfate	0	104	0	10	X	O	O	O	O	
Ammonium Sulfate	0	120	10	100	X	X	O	O	O	
Ammonium Sulfate	104	120	0	10	X	X	O	O	-	
Ammonium Sulfate	120	160	0	10	-	-	X	O	-	
Ammonium Sulfate	120	149	10	100	-	-	X	O	-	
Ammonium Sulfide	0	70	0	100	-	O	O	-	-	
Ammonium Sulfide	40	60	0	100	-	O	-	O	-	
Ammonium Thioglycolate					O	O	-	-	-	
Ammonium Thiosulfate					-	O	-	-	O	
Amyl Chloride	0	60	0	100	O	O	O	O	X	
Amyl Chloride	60	120	0	100	-	-	O	O	-	

SS = Stainless steel
C22 = Nickel alloy C22

TZ = Tefzel-lined 316L
TA = Tantalum
TI = Titanium

See page 9 for material compatibility codes.

Material compatibility for Coriolis meters *continued*

Fluid name	Temp. (°C)		Conc. (%wt)		Material compatibility					Notes
	Low	High	Low	High	SS	C22	TZ	TA	TI	
Amyl Chloride	120	148	0	100	–	–	X	O	–	
Amyl Mercaptan	0	160	0	100	–	O	X	O	–	
Amylphenol	0	200	0	100	–	O	X	O	–	
Aniline	0	110	0	100	O	O	O	O	O	
Aniline	110	120	0	100	O	O	O	–	–	
Aniline	120	265	0	100	O	–	–	–	–	
Animal Fat					–	O	O	–	O	
Anodizing Solution Aluminum					–	O	–	O	–	
Anthracene Oil	80	90	0	100	O	–	–	–	–	
Anthraquinone					–	–	O	–	–	
Antibiotic Fermentation Media					–	O	–	O	–	
Antimony Pentachloride	0	71	0	50	X	O	O	O	–	
Apple Juice					O	O	O	O	O	
Aqua Quinine					O	O	–	–	–	
Aqua Regia	0	20	0	75	X	X	X	O	O	
Aqua Regia	20	82	0	75	X	X	X	O	–	
Argon					O	O	O	O	O	
Arsenic Acid	0	52	0	100	O	X	O	–	–	
Arsenic Acid	52	120	0	100	X	–	O	–	–	
Asphalt	0	60	0	100	O	–	X	–	O	
Asphalt	60	200	0	100	O	–	X	O	O	
Atropine	0	60	0	100	–	O	–	–	–	
Barium Sulfate	0	93	0	100	X	O	O	X	O	
Barium Sulfate	93	120	0	100	–	–	O	–	–	
Beef Tallow					O	O	–	X	O	
Beer	0	37	0	100	O	O	O	O	O	
Beer	37	150	0	100	O	–	–	–	O	
Beeswax Bleach Solution	0	104	0	100	–	O	–	O	–	
Benzene	0	116	0	100	O	O	O	O	O	
Benzene Hexachloride	0	200	0	100	X	O	–	–	–	
Benzoic Acid	0	82	0	10	X	O	O	O	O	
Benzoic Acid	0	104	10	100	–	–	O	O	O	
Benzoic Acid	104	120	10	100	–	–	O	–	O	
Benzophenone					–	O	–	–	–	
Benzoquinine					O	O	–	O	–	
Benzoyl Chloride					–	O	O	O	–	
Benzoyl Peroxide					–	O	O	O	–	
Benzyl Chloride	0	50	0	100	X	O	O	C	O	
Benzyl Chloride	0	120	0	100	X	X	O	C	–	
Black Acid	0	210	0	100	X	X	X	O	–	

SS = Stainless steel
C22 = Nickel alloy C22

TZ = Tefzel-lined 316L
TA = Tantalum
TI = Titanium

See page 9 for material compatibility codes.

Material compatibility for Coriolis meters *continued*

Fluid name	Temp. (°C)		Conc. (%wt)		Material compatibility					Notes
	Low	High	Low	High	SS	C22	TZ	TA	TI	
Black Liquor	20	90	0	100	O	O	O	X	X	
Bleach					X	O	O	O	O	
Boric Acid	0	30	0	10	O	O	O	O	O	
Boric Acid	0	120	0	10	X	O	O	O	O	
Boric Acid	120	150	0	10	-	O	X	O	-	
Boric Acid	150	250	0	10	-	O	-	-	-	
Boron Sulfate					-	O	-	O	-	
Boron Trifluoride					-	O	-	-	-	
Boron Trifluoride Etherate	0	57	0	100	-	O	-	-	-	
Brine					X	O	O	O	O	
Bromethylbenzene					X	-	O	O	-	
Bromine	0	20	0	100	X	X	O	O	O	Moist gas
Bromine	0	66	0	100	X	O	O	O	X	Anhydrous gas
Bromine	20	150	0	100	X	-	-	O	-	Moist gas
Butadiene	0	60	0	100	O	O	O	-	-	
Butadiene	60	120	0	100	-	O	O	-	-	
Butane					O	O	O	O	O	
Butanol					O	-	-	O	O	
Butyl Acetate	0	120	0	100	O	O	O	O	O	
Butyl Aldehyde					O	-	-	O	-	
Butylamine					O	O	-	-	-	
Butylene Glycol					-	-	-	-	-	
Calcium Carbonate					O	O	O	O	O	
Calcium Chloride	0	93	0	40	X	O	O	O	O	
Calcium Chloride	0	93	40	100	X	O	O	-	O	
Calcium Chloride	93	120	0	40	X	-	O	O	O	
Calcium Chloride	93	120	40	100	X	O	O	-	X	
Calcium Chloride	120	200	4	100	X	O	-	-	-	
Calcium Hydroxide	0	50	0	50	O	O	O	X	O	
Calcium Hydroxide	0	100	0	50	X	O	O	X	X	
Calcium Lignosulphonate					-	O	-	-	-	
Calcium Pyridine Sulfonate	0	66	0	100	-	O	X	-	-	
Calcium Sulfide	0	47	0	100	X	O	O	O	-	
Canola Oil					O	O	-	-	-	
Carbolite					O	O	O	O	-	
Carbon Dioxide	0	120	0	100	O	O	O	O	O	Dry
Carbon Dioxide	0	120	0	100	X	C	O	O	O	
Carbon Disulfide	0	43	0	100	O	-	O	O	O	
Carbon Disulfide	43	65	0	100	-	-	O	X	O	
Carbon Disulfide	65	93	0	100	-	-	-	-	O	

SS = Stainless steel
C22 = Nickel alloy C22

TZ = Tefzel-lined 316L
TA = Tantalum
TI = Titanium

See page 9 for material compatibility codes.

Material compatibility for Coriolis meters *continued*

Fluid name	Temp. (°C)		Conc. (%wt)		Material compatibility					Notes
	Low	High	Low	High	SS	C22	TZ	TA	TI	
Carbon Tetrachloride	0	60	0	100	O	O	O	O	O	Anhydrous
Carbon Tetrachloride	60	120	0	100	-	-	O	O	O	Anhydrous
Carbon Tetrachloride					X	O	O	O	O	Moist
Carbon Tetrafluoride					X	-	-	-	-	
Carbonic Acid					X	O	O	O	O	Wet
Carbonochloric Acid					X	O	-	O	-	
Carboxylic Acid Salts					-	O	-	-	-	
Ceda Clean					-	O	-	-	-	
Cement					O	O	O	-	-	
Cerium Acetate					-	O	-	O	-	
Cetylpyridinium					O	O	-	-	-	
Cetylpyridinium Chloride					X	O	O	O	-	
Chloric Acid	0	31	0	20	X	O	O	O	-	
Chloric Acid	0	70	0	50	X	X	O	O	-	
Chlorinated Hydrocarbons					X	O	O	O	-	
Chlorinated Phenol					X	O	O	O	-	
Chlorinated Pyridine					X	O	O	O	-	
Chlorinated, Fluorinated Pyridines					X	O	X	O	-	
Chlorine	0	104	0	100	X	O	O	O	X	Anhydrous gas or liquid
Chlorine	0	120	0	100	X	O	O	O	-	Gas
Chlorine Dioxide					X	O	O	O	O	
Chloro Nitro Ethane					X	O	-	O	-	
Chloro Trifluoroethylene	0	49	0	100	-	O	-	O	-	
Chloroacetic Acid					X	O	O	O	O	
Chloroacetyl Chloride					X	O	-	O	-	
Chlorobenzene	0	38	0	60	X	O	O	O	O	
Chlorodifluoroethane					X	O	O	-	-	
Chlorodifluoromethane					X	-	O	-	-	
Chloroform	0	21	0	100	O	O	O	O	O	
Chloroform	21	95	0	100	X	X	O	O	O	
Chloroform	95	104	0	100	X	X	O	O	O	
Chlorophenol	0	60	0	5	X	O	O	-	-	
Chloropicrin	0	95	0	0	X	O	-	O	-	
Chlorosilane					-	O	O	O	-	
Chlorosulfonic Acid	0	85	0	100	X	O	X	O	X	
Chlorotetrahydrophthalic Anhydride					X	O	-	O	-	
Chocolate					O	-	O	-	O	
Choline Chloride					X	O	-	O	-	

SS = Stainless steel
C22 = Nickel alloy C22

TZ = Tefzel-lined 316L
TA = Tantalum
TI = Titanium

See page 9 for material compatibility codes.

Material compatibility for Coriolis meters *continued*

Fluid name	Temp. (°C)		Conc. (%wt)		Material compatibility					Notes
	Low	High	Low	High	SS	C22	TZ	TA	TI	
Chromic Oxide					–	O	–	O	–	Based on 50% chromic acid
Chromiumtrioxide			0	100	–	–	–	–	O	Chromic acid
Chromium Sulfate					O	O	–	O	–	
Citric Acid	0	100	0	50	O	O	O	O	O	
Citric Acid	100	120	0	50	X	O	O	O	X	
Coal Tar Fuel					O	O	X	O	–	
Coal Tar Pitch					O	O	X	O	–	
Cobalt Hydroxide	0	200	0	100	X	–	O	X	–	
Cobalt Octoate					O	O	–	–	–	
Cocoa Butter					O	–	O	O	O	
Coconut Oil					O	–	O	O	O	
Coke Gas Oil					O	O	O	O	–	
Compressed Natural Gas					O	O	O	O	O	
Concrete					O	O	O	O	–	
Copper Bromide					X	–	O	O	–	
Copper Sulfate	0	104	0	100	X	O	O	O	O	
Corn Oil					O	O	O	O	O	
Corn Oil and Garlic					O	O	O	O	–	
Corn Steep Liquor					O	O	O	O	–	
Corn Syrup					O	O	O	O	O	
Creosote Oil					X	O	–	–	O	
Cresol					O	O	O	–	O	
Cresylic Acid	0	100	0	100	–	O	X	O	O	
Crude Geranyl Ester					O	O	O	O	–	
Cupric Bromide	0	30	0	100	X	X	–	O	–	
Cupric Chloride	0	104	0	5	X	X	O	O	O	
Cupric Chloride	0	21	5	50	X	O	–	O	O	
Cupric Chloride	21	120	5	50	X	X	–	O	O	
Cyanogen Chloride	0	46	0	20	–	O	–	O	–	
Cyclohexane	0	93	0	100	O	X	O	X	O	
Cyclohexane	93	120	0	100	O	X	O	–	O	
Cyclopropylamine					O	O	–	–	–	
Decane Sulfonyl Fluoride					X	–	O	–	–	
Diacryl Phthalate	0	15	0	100	O	–	–	O	–	
Dibromobenzene	0	200	0	100	X	–	–	O	–	
Dichloroacetyl Chloride					X	–	O	–	–	
Dichlorobenzene					X	O	O	–	X	
Dichlorobutene					X	O	–	O	–	
Dichlorodifluoromethane	0	21	0	100	X	O	O	O	O	
Dichlorodifluoromethane	21	71	0	100	X	–	O	–	–	

SS = Stainless steel
C22 = Nickel alloy C22

TZ = Tefzel-lined 316L
TA = Tantalum
TI = Titanium

See page 9 for material compatibility codes.

Material compatibility for Coriolis meters *continued*

Fluid name	Temp. (°C)		Conc. (%wt)		Material compatibility					Notes
	Low	High	Low	High	SS	C22	TZ	TA	TI	
Dichlorofluoroethane					–	O	–	O	O	
Dichlorophenol	0	120	0	100	X	O	O	O	–	
Dichlorotrifluoroethane					X	–	O	–	–	
Diesel Fuel	0	38	0	100	O	O	O	–	X	
Diesel Fuel	38	120	0	100	O	O	O	–	–	
Diethanolamine	0	100	0	100	O	O	–	O	O	
Diethyl Aluminum Chloride					X	–	–	O	–	
Diethyl Disulfide	0	90	0	100	–	O	–	O	–	
Diethyl Sulfate					–	O	O	O	–	
Diethyl Sulfide					–	O	O	O	–	
Diethylamine	0	120	0	100	O	X	O	–	X	
Diethylene Glycol	0	52	0	100	O	X	O	–	O	
Diethylene Glycol	52	76	0	100	O	–	–	–	O	
Difluorobenzonitrile					–	–	O	–	–	
Difluoromonoethane					–	O	–	–	–	
Dihydrogen Sulfide					–	O	O	O	–	
Diisononylphthalate					O	O	–	–	–	
Diisopropyl Peroxydicarbonate					O	O	–	–	–	
Dimethyl Aminoethyl Methacrylate					O	–	–	O	–	
Dimethyl Chloride					X	O	–	O	–	
Dimethyl Dichloride					X	O	O	O	–	
Dimethyl Formaldehyde					O	–	–	O	–	
Dimethyl Hydrazine					O	O	–	–	–	
Dimethyl Malonate	0	100	0	100	–	O	–	O	–	
Dimethyl Succinate			0	100	O	O	–	O	–	
Dimethyl Sulfate					O	O	O	O	–	
Dimethyl Sulfide					O	O	O	O	–	
Dimethyl Terephthalate					O	–	X	O	–	
Dimethylacetamide	0	200	0	100	X	–	–	–	–	
Dimethylamine	25	180	0	100	O	–	X	O	–	
Dimethylpolysiloxanes					O	O	O	O	–	
Dinitrotoluene					O	O	–	O	–	
Diphenyl Methane Diisocyanate					O	O	–	–	–	
Diphenylamine	0	100	0	100	–	O	X	O	–	
Dipropyl Peroxydicarbonate					O	O	–	–	–	
Disobutylene					O	O	–	O	–	
Disodium Iminodiacetate					X	–	–	–	–	
Divinylbenzene					O	O	–	–	–	
Dodecyl Mercaptan					O	O	–	O	–	
Dodecylbenzene Sulfonic Acid					–	O	–	–	–	

SS = Stainless steel
C22 = Nickel alloy C22

TZ = Tefzel-lined 316L
TA = Tantalum
TI = Titanium

See page 9 for material compatibility codes.

Material compatibility for Coriolis meters *continued*

Fluid name	Temp. (°C)		Conc. (%wt)		Material compatibility					Notes
	Low	High	Low	High	SS	C22	TZ	TA	TI	
Drilling Mud					O	O	-	-	O	
Egg Slurry					O	O	O	O	O	
Epichlorohydrine	0	60	0	100	O	O	O	O	-	Dry
Epoxy Resin					O	O	-	-	O	
Ercimide					-	O	-	O	-	
Ester Vinyl Ether					X	O	O	-	-	
Ether	20	100	0	100	O	X	O	O	O	
Ethyl Acetate	20	65	0	100	O	O	O	O	O	
Ethyl Alcohol					O	-	O	O	O	
Ethyl Benzene	0	60	0	100	O	O	O	-	-	
Ethyl Benzene	60	100	0	100	O	O	-	-	-	
Ethyl Monochloroacetate					X	O	X	O	-	
Ethylbenzene Sulfonyl Fluoride					-	O	O	-	-	
Ethylene					O	O	O	O	-	Gas
Ethylene Chlorohydrin	0	100	0	100	X	O	O	-	X	
Ethylene Diamine	0	37	0	100	O	X	O	X	O	
Ethylene Diamine	37	43	0	100	-	-	O	-	-	
Ethylene Dichloride	0	93	0	100	X	O	O	O	C	
Ethylene Glycol	0	120	0	100	O	O	O	O	O	
Ethylene Glycol	120	200	0	100	-	O	-	-	-	
Ethylene Glycol/Bromoform				97	X	-	X	O	-	
Ethylene Oxide	0	31	0	100	O	O	O	O	O	
Ethylene Oxide	31	120	0	100	O	-	O	-	-	
Ethylproplacrolein					O	O	-	-	-	
Evaposhine					X	O	X	O	-	
Fat/Garlic					O	O	O	-	O	
Fatty Acid	0	120	0	100	O	O	O	O	O	
Fatty Acid	120	200	0	100	O	O	X	O	-	
Ferric Chloride	0	25	0	10	X	O	O	O	O	
Ferric Chloride		80		100	X	X	O	O	O	
Ferric Nitrate	0	20	0	100	X	O	O	O	O	
Ferric Nitrate	20	120	0	100	X	-	O	-	O	
Ferric Nitrite					O	O	-	O	-	
Ferric Sulfate	0	60	0	10	O	O	O	O	O	
Ferric Sulfate	0	60	10	30	-	O	O	O	O	
Ferric Sulfate	0	98	30	100	-	-	O	O	O	
Ferric Sulfate	60	98	0	10	-	-	O	O	O	
Ferric Sulfate	60	98	10	30	-	-	O	O	O	

SS = Stainless steel
C22 = Nickel alloy C22

TZ = Tefzel-lined 316L
TA = Tantalum
TI = Titanium

See page 9 for material compatibility codes.

Material compatibility for Coriolis meters *continued*

Fluid name	Temp. (°C)		Conc. (%wt)		Material compatibility					Notes
	Low	High	Low	High	SS	C22	TZ	TA	TI	
Ferrous Chloride	0	25	0	10	–	O	–	–	–	
Ferrous Chloride	0	120	0	100	X	X	O	O	O	
Ferrous Sulfate	0	120	0	100	X	O	O	O	O	
Fluorine					X	O	O	X	O	Dry
Fluoroalcohol					X	–	O	–	–	
Fluorobenzene					X	–	O	–	–	
Fluorosulfonic Acid					X	–	–	O	–	
Fluorotrichloromethane					X	–	O	–	–	
Food Product					–	O	O	O	O	
Formaldehyde					O	–	O	–	X	
Formic Acid	0	30	0	10	O	O	O	O	O	Aerated
Formic Acid	0	100	0	5	X	O	O	O	O	Aerated
Formic Acid	0	104	10	85	X	O	O	O	X	
Formic Acid	100	120	0	5	X	–	O	O	O	Aerated
Formic Acid	120	153	0	5	X	–	X	O	O	Aerated
Fruit Juice					O	O	O	O	O	
Gasoline	0	43	0	100	O	O	O	O	O	
Gasoline	43	120	0	100	–	O	O	–	–	
Gelatin					O	–	–	–	O	
Glycerine	0	104	0	100	O	O	O	O	O	
Glycolite					O	O	O	O	–	
Glyoxalic Acid	0	50			X	O	–	O	–	
Green Liquor					–	O	O	–	X	
Halogenated Alkyl Ether					X	–	–	O	–	
Halogenated Alkyl Ether					X	O	O	O	–	
Halogenated Styrene					–	O	–	O	–	
Helium					O	O	O	O	O	
Heptane	0	60	0	100	O	O	O	O	O	
Heptane	60	98	0	100	–	O	O	–	O	
Hexachlorocyclopentadiene					X	X	–	O	–	Chlorinated cyclic olefin (C5Cl6)
Hexafluoropropene					–	O	–	O	–	
Hexahydrophthalic Anhydride					O	O	–	–	–	
Hexamethylenediisocyanate					–	O	–	O	–	
Hexane					O	O	O	X	O	
Hydrazine					O	O	O	–	–	
Hydrobromic Acid					X	X	O	O	X	

SS = Stainless steel
C22 = Nickel alloy C22

TZ = Tefzel-lined 316L
TA = Tantalum
TI = Titanium

See page 9 for material compatibility codes.

Material compatibility for Coriolis meters *continued*

Fluid name	Temp. (°C)		Conc. (%wt)		Material compatibility					Notes
	Low	High	Low	High	SS	C22	TZ	TA	TI	
Hydrochloric Acid ⁽¹⁾	0	30	0	5	X	O	O	O	X	
Hydrochloric Acid ⁽¹⁾	0	120	0	15	X	C	O	O	X	
Hydrochloric Acid ⁽¹⁾	0	120	15	38	X	X	C	O	X	
Hydrochloric Acid ⁽¹⁾	120	200	0	38	X	X	X	O	X	
Hydrochloric Acid Slurry ⁽¹⁾			0	15	X	O	O	O	–	
Hydrofluoric Acid	0	120	0	100	X	X	O	X	X	Aqueous
Hydrofluosilicic Acid			10	50	X	X	O	X	X	
Hydrogen	0	120	0	100	O	O	O	X	O	
Hydrogen	120	200	0	100	O	O	X	X	O	
Hydrogen Bromide					X	X	–	O	–	
Hydrogen Chloride					X	–	O	O	X	Moist
Hydrogen Chloride					O	O	O	O	X	Anhydrous
Hydrogen Cyanide	0	31	0	100	O	O	O	–	O	
Hydrogen Cyanide	31	53	0	100	–	O	O	–	–	
Hydrogen Cyanide	53	120	0	100	–	–	O	–	–	
Hydrogen Fluoride	0	43	0	100	O	O	O	X	O	Anhydrous
Hydrogen Peroxide	0	90	0	5	O	O	O	X	X	
Hydrogen Peroxide	0	90	0	50	O	O	O	X	X	Acid free
Hydrogen Peroxide	0	48	50	90	O	O	O	X	X	
Hydrogen Sulfide	0	31	0	100	O	O	O	O	O	Anhydrous gas
Hydrogen Sulfide	0	38	0	100	X	O	O	O	O	Moist gas
Hydrogen Sulfide	31	82	0	100	O	O	O	O	–	Anhydrous gas
Hydrogen Sulfide	38	120	0	100	X	–	O	O	–	Moist gas
Hydrogen Sulfide	82	120	0	100	X	–	O	O	–	Anhydrous gas
Hydrogen Sulfide					X	X	O	O	O	Aqueous solution
Hydroquinone					O	O	O	O	X	
Hydroxymethyl Ester					O	O	–	–	–	
Hydroxyphenylethanone					O	O	–	–	–	
Hydroxypropylmethylcellulose					X	–	–	O	–	Opadry
Hypochlorite					X	O	O	O	–	
Hypochlorous Acid					X	O	O	O	O	
Ice Cream					O	O	O	O	O	
Igepon Surfactant					O	O	–	–	–	
Ink					O	–	–	O	O	
Insulin Extract					–	O	–	O	–	
Iron Sulfate					X	O	O	O	–	
Isobutanol					O	–	–	O	O	
Isobutyl Acetate					O	–	–	O	–	

SS = Stainless steel
C22 = Nickel alloy C22

TZ = Tefzel-lined 316L
TA = Tantalum
TI = Titanium

See page 9 for material compatibility codes.

(1) Refer to page 32 for additional information about HCl.

Material compatibility for Coriolis meters *continued*

Fluid name	Temp. (°C)		Conc. (%wt)		Material compatibility					Notes
	Low	High	Low	High	SS	C22	TZ	TA	TI	
Isooctyl Alcohol					O	O	-	-	-	
Isopar E					O	O	-	-	-	
Isopentane					O	O	-	-	-	
Isopropyl Acetate					O	O	O	-	-	
Isopropyl Alcohol					O	O	O	O	O	
Isopropylamine					O	O	-	-	-	
Jet Fuel	0	30	0	100	O	O	O	O	O	
Kathon Lx 1.5% Biocide					X	O	O	O	-	
Kerosene					O	O	O	O	O	
Ketchup					O	O	O	O	O	
Lactic Acid	0	49	0	10	O	O	O	O	O	
Lactic Acid	0	49	10	25	O	O	O	O	O	
Lactic Acid	49	104	0	10	X	O	O	O	O	
Lactic Acid	49	60	10	25	X	O	O	O	O	
Lactic Acid	104	120	0	10	-	-	O	O	O	
Lactic Acid			25	100	X	X	O	O	O	
Lactose	0	100	0	100	O	-	-	-	-	
Laoquer Thinner/Lupranate					O	O	-	O	O	
Lard Oil					O	O	O	O	O	
Lasso Herbicide					X	-	-	O	-	
Latex	0	60	0	100	O	-	-	-	O	
Latex Emulsion					O	O	O	-	O	
Lauryl Bromide					X	O	O	O	-	
Lead Acetate	0	104	0	100	O	O	O	O	O	
Lime Slurry	0	55	0	100	X	O	-	-	O	
Limestone	0	49	0	8	O	O	O	O	O	Maintain velocity < 10ft/sec
Liquefied Petroleum Gas					O	O	-	O	O	
Lithium Bromide					X	O	O	O	-	
Lithium Chloride	0	100	0	60	X	O	O	O	O	
Magnesium Chloride	0	120	0	100	X	O	O	O	O	
Magnesium Chloride	120	153	50	100	X	O	X	O	-	
Magnesium Hydroxide	0	100	0	100	O	O	O	O	O	
Magnesium Hydroxide	100	120	0	100	-	-	O	-	-	
Magnesium Nitrate	0	93	0	100	O	O	O	O	O	
Magnesium Oxide					O	O	O	O	O	
Magnesium Silicate					O	O	O	-	-	
Magnesium Sulfate	0	93	0	50	-	O	O	O	O	
Magnetic Slurries					-	O	O	O	-	
Maleic Acid	0	80	0	100	O	O	O	O	O	
Maleic Acid	80	120	0	100	X	-	O	-	O	

SS = Stainless steel
C22 = Nickel alloy C22

TZ = Tefzel-lined 316L
TA = Tantalum
TI = Titanium

See page 9 for material compatibility codes.

Material compatibility for Coriolis meters *continued*

Fluid name	Temp. (°C)		Conc. (%wt)		Material compatibility					Notes
	Low	High	Low	High	SS	C22	TZ	TA	TI	
Maleic Anhydride					O	O	O	O	O	
Malumar					O	O	-	-	-	
Manganese Cobalt Acetate					O	O	-	-	-	
Manganese Sulfate	0	63	0	100	-	O	-	O	O	
Mayonnaise					O	O	O	O	O	
Mercaptan					O	O	-	O	-	
Mercapto Ethanol					O	O	-	-	-	
Methacrylic Acid					O	O	-	O	-	
Methane					O	O	O	O	O	
Methanol	0	100	0	100	O	O	O	O	X	
Methyl Acetate	0	60	0	60	O	O	-	-	-	
Methyl Acrylate					O	O	-	O	-	
Methyl Acrylic Acid					-	O	-	O	-	
Methyl Alcohol	0	100	0	100	O	O	O	O	X	
Methyl Benzimidazole Zinc Salt					-	O	-	O	-	
Methyl Bromide	0	20	0	100	O	-	O	O	O	
Methyl Bromide	20	120	0	100	-	-	O	-	-	
Methyl Chloride	0	104	0	100	X	O	O	O	O	
Methyl Chloride	0	120	0	100	O	O	O	O	O	Anhydrous
Methyl Ethyl Ketone	0	93	0	100	O	O	O	O	O	
Methyl Iodide					X	-	-	O	-	
Methyl Methacrylate					O	O	-	O	-	Use DL meter
Methylamine					O	-	X	O	X	
Methyldichlorosilane					X	O	-	O	-	
Methylene Chloride	0	30			O	O	O	O	O	Anhydrous
Methylene Chloride	0	30	0	100	X	X	O	O	O	
Methylene Chloride	0	120	0	100	X	X	O	O	O	
Methylpyrrolidone					O	O	-	-	-	
Mineral Oil					O	O	O	O	O	
Mineral Spirits					O	O	-	O	-	
Molasses					O	O	O	O	O	
Monochlorobenzene					X	O	O	O	X	
Monochlorodifluoromethane					O	O	O	O	O	
Monoethanoamine Hydrochloride	0	65	0	100	-	O	X	O	-	
Monoethanol Amine					X	O	O	O	O	
Monoethanolamine	0	100	0	90	O	O	O	O	O	
Morpholine					O	O	-	X	-	
Musk Concentrate					O	O	-	-	-	
Mustard Gas					X	-	O	O	-	
Nadir Methyl Anhydride					O	O	-	-	-	

SS = Stainless steel
C22 = Nickel alloy C22

TZ = Tefzel-lined 316L
TA = Tantalum
TI = Titanium

See page 9 for material compatibility codes.

Material compatibility for Coriolis meters *continued*

Fluid name	Temp. (°C)		Conc. (%wt)		Material compatibility					Notes
	Low	High	Low	High	SS	C22	TZ	TA	TI	
Nalco 625					–	O	–	–	–	
Naphtha					O	O	O	O	O	
Naphthalene	0	120	0	100	O	O	O	O	O	
Naphthalene Sulfonic Acid	0	200	0	100	–	O	X	O	–	
Neopentyl Glycol					–	O	–	–	–	
Nickel Chloride	0	90	0	100	X	O	O	O	O	
Nickel Slurry					O	O	O	–	–	
Nitric Acid ⁽¹⁾	–18	10	0	75	O	O	O	O	O	304L O
Nitric Acid ⁽¹⁾	–18	10	75	100	O	O	O	O	O	304L O
Nitric Acid ⁽¹⁾	10	24	0	70	O	X	O	O	O	304L O
Nitric Acid ⁽¹⁾	10	24	70	100	O	X	O	O	O	304L O
Nitric Acid ⁽¹⁾	24	38	0	20	O	O	O	O	O	304L O
Nitric Acid ⁽¹⁾	24	38	20	50	O	X	O	O	O	304L O
Nitric Acid ⁽¹⁾	24	38	50	70	X	X	O	O	X	304L O
Nitric Acid ⁽¹⁾	24	38	70	90	X	X	X	O	X	304L O
Nitric Acid ⁽¹⁾	24	38	90	100	X	X	X	O	X	304L X
Nitric Acid ⁽¹⁾	38	52	0	10	O	O	O	O	O	304L O
Nitric Acid ⁽¹⁾	38	52	10	40	O	X	O	O	O	304L O
Nitric Acid ⁽¹⁾	38	52	40	70	X	X	O	O	X	304L O
Nitric Acid ⁽¹⁾	38	52	70	80	X	X	X	O	X	304L O
Nitric Acid ⁽¹⁾	38	52	80	100	X	X	X	O	X	304L X
Nitric Acid ⁽¹⁾	52	66	0	30	O	X	O	O	O	304L O
Nitric Acid ⁽¹⁾	52	66	30	70	X	X	O	O	X	304L O
Nitric Acid ⁽¹⁾	52	66	70	100	X	X	X	O	X	304L X
Nitric Acid ⁽¹⁾	66	80	0	20	O	X	O	O	X	304L O
Nitric Acid ⁽¹⁾	66	80	20	45	X	X	O	O	X	304L O
Nitric Acid ⁽¹⁾	66	80	45	55	X	X	X	O	X	304L O
Nitric Acid ⁽¹⁾	66	80	55	100	X	X	X	O	X	304L X
Nitric Acid ⁽¹⁾	80	93	0	45	X	X	O	O	X	304L X
Nitric Acid ⁽¹⁾	80	93	45	100	X	X	X	O	X	304L X
Nitric Acid ⁽¹⁾	93	163	0	100	X	X	X	O	X	304L X
Nitroaniline					X	O	–	O	–	
Nitrobenzene					O	O	O	O	O	
Nitrochlorobenzene					X	O	–	O	–	
Nitrogen					O	O	O	O	O	
Nonanoic Acid Sludge					X	O	X	O	–	
Nonyl Phenol					O	O	–	O	–	
Octanol					O	O	–	–	–	

SS = Stainless steel
C22 = Nickel alloy C22

TZ = Tefzel-lined 316L
TA = Tantalum
TI = Titanium

See page 9 for material compatibility codes.

(1) Refer to page 34 for additional information about HNO₃.

Material compatibility for Coriolis meters *continued*

Fluid name	Temp. (°C)		Conc. (%wt)		Material compatibility					Notes
	Low	High	Low	High	SS	C22	TZ	TA	TI	
Oil Emulsion					O	O	O	O	O	
Oil, Crude					O	O	O	O	O	
Oil, Fuel					O	O	O	O	O	
Oil, Gas					O	O	O	O	O	
Oil, Hydraulic Cylinder					O	O	O	O	O	
Oil, Lube					O	O	O	O	O	
Oil, Soybean					O	O	O	O	O	
Oil, Spindle					O	O	O	O	O	
Oil, Transformer					O	O	-	O	O	
Oil, Turpentine					O	O	O	O	O	
Oil, Vegetable	0	43	0	100	O	O	O	O	O	
Oil, Vegetable	43	104	0	100	O	-	O	O	-	
Oil, Waste					X	O	-	-	-	
Oleum	20	50	0	100	-	O	O	O	-	
Orange Juice					O	O	O	O	O	
Oxalic Acid	0	104	0	10	X	O	O	O	X	
Oxygen					O	O	O	O	X	
Ozonated Water					O	-	O	-	O	
Ozone					O	O	O	-	O	
Paint					O	O	O	O	-	
Palmitic Acid					O	-	O	-	-	
Paper Pulp	0	74	0	15	X	O	-	-	-	Chlorine bleached
Paraffine					O	O	-	O	O	
Paranitrochlorinebenzene					X	-	X	O	-	
Pentamethyl Indan					O	O	-	-	-	
Pentane					O	O	O	O	O	
Perchloroethylene					O	O	O	O	O	
Perfluorochemical Inert Liquid					X	-	O	-	-	
Peroxide Acid					-	O	-	O	-	
Phenol			0	95	-	O	X	O	-	
Phenol					O	O	O	O	-	
Phenol Formaldehyde	0	130	0	100	-	O	X	O	-	
Phenolsulfonic Acid					O	O	-	O	-	
Phenothiazine					O	O	-	O	-	
Phosgene	20	65	0	100	X	O	O	O	-	
Phosphoric Acid	0	25	0	70	O	O	O	O	X	Food grade
Phosphoric Acid			0	5	O	O	O	O	O	
Phosphoric Acid			5	40	X	O	O	O	X	
Phosphoric Acid			40	98	X	O	O	O	X	
Phosphoric Acid			98	100	X	X	O	O	X	

SS = Stainless steel
C22 = Nickel alloy C22

TZ = Tefzel-lined 316L
TA = Tantalum
TI = Titanium

See page 9 for material compatibility codes.

Material compatibility for Coriolis meters *continued*

Fluid name	Temp. (°C)		Conc. (%wt)		Material compatibility					Notes
	Low	High	Low	High	SS	C22	TZ	TA	TI	
Phosphoric Acid/Sodium Hydroxide					X	O	-	O	-	
Phosphorous					X	O	X	O	-	
Phosphorous Acid					X	O	X	O	-	
Phosphorous Oxychloride					X	-	X	O	C	
Phosphorous Trichloride					X	X	O	O	O	
Phthalic Acid					O	O	O	O	O	
Phthalic Anhydride	-18	99	98	100	O	O	C	C	-	
Phthalic Anhydride	99	149	98	100	O	O	X	C	-	
Phthalic Anhydride	149	204	98	100	O	O	X	-	-	
Phthalic Anhydride/Thermon					-	O	-	O	-	
Picric Acid					O	O	O	O	O	
Pitch	100	200	0	100	O	-	X	O	O	
Pivalic Acid					O	O	-	-	-	
Platinum Chloride					X	-	O	O	-	
Polyacrylamide					O	O	-	-	-	
Polyamine	0	182	0	100	-	O	X	O	-	
Polybutyl Chloride					X	O	-	O	-	
Polydimethylaminetetra-chlorohydrate					-	O	-	O	-	
Polyester					O	O	-	O	-	
Polyethylene					O	O	-	O	-	
Polyethylene Glycol					O	O	O	O	O	
Polyethylene Wax					O	O	O	-	O	
Polyisobutylene					O	O	-	-	-	
Polyol					O	O	-	-	-	
Polyphosphorous					X	O	X	O	-	
Polyvinyl Alcohol					O	O	-	O	-	
Potassium Acetate					-	-	X	-	-	
Potassium Bisulfite	0	63	0	100	-	O	O	O	-	
Potassium Bromide	0	31	0	30	X	O	O	O	O	
Potassium Bromide	0	104	30	50	X	X	O	-	O	
Potassium Bromide	0	104	50	100	-	-	O	-	O	
Potassium Carbonate					O	O	O	O	O	
Potassium Carbonate					X	O	O	O	O	
Potassium Chloride	0	110	0	99	X	O	X	O	O	
Potassium Chloride	0	160	0	99	X	X	X	O	O	
Potassium Chromate	0	24	0	10	X	O	O	O	-	
Potassium Hydroxide	0	93	0	40	O	O	O	X	X	
Potassium Hydroxide	0	100	40	50	X	O	O	X	X	

SS = Stainless steel
C22 = Nickel alloy C22

TZ = Tefzel-lined 316L
TA = Tantalum
TI = Titanium

See page 9 for material compatibility codes.

Material compatibility for Coriolis meters *continued*

Fluid name	Temp. (°C)		Conc. (%wt)		Material compatibility					Notes
	Low	High	Low	High	SS	C22	TZ	TA	TI	
Potassium Iodide					O	–	O	O	O	
Potassium Nitrate	0	100			X	O	O	O	O	
Potassium Permanganate	0	100	0	50	X	O	O	O	O	
Potassium Persulfate	0	24	0	4	X	O	O	O	–	
Potassium Persulfate					O	–	–	O	–	
Primary Stearyl Amine					O	O	–	–	–	
Propane					O	O	O	O	O	
Propionic Acid	0	140	0	97	–	O	X	O	–	
Propyl Alcohol	0	104	0	100	O	O	O	O	O	
Propylene					O	O	O	O	O	
Propylene Glycol					O	O	O	O	O	
Propylene Oxide					O	O	O	O	–	
Pyridine					X	X	O	O	X	
Rhodium					O	O	O	O	–	
Rosin	0	200	0	100	–	O	X	O	–	
Roundup Herbicide					X	O	–	O	–	
Rubber Cement					O	O	O	–	–	
Rubber Hydrocarbon					O	O	–	–	–	
Safety-kleen 105					O	O	O	O	–	
Salicylic Acid	0	120	0	100	X	O	O	O	O	
Scalp Oil					X	O	O	O	O	
Sebacic Acid	0	104	0	10	–	O	–	O	–	
Sentol (Liquid Acid Cleaner)					–	O	–	O	–	
Silica Slurry					O	O	O	O	–	
Silicon Dioxide					O	O	O	O	–	
Silicon Tetrafluoride					X	–	O	O	–	
Silicone					O	O	O	O	O	
Silicone Oil					O	O	O	O	O	
Silicontetrachloride Slurry					O	O	O	O	–	
Silver Nitrate					O	O	O	O	O	
Soap Fat	0	200	0	100	–	O	X	O	O	
Soap Solution					O	O	O	O	O	
Sodium Alkyl Glyceryl Sulfonate					–	O	O	–	–	
Sodium Aluminate					O	O	–	–	O	
Sodium Bicarbonate			0	20	O	O	O	O	O	
Sodium Bicarbonate			20	100	–	–	O	O	O	
Sodium Bisulfate	0	82	0	20	X	O	O	O	O	
Sodium Bisulfite					X	O	O	X	X	
Sodium Carbonate	0	100	0	25	O	O	O	O	O	
Sodium Carbonate	0	100	25	100	O	O	O	–	O	

SS = Stainless steel
C22 = Nickel alloy C22

TZ = Tefzel-lined 316L
TA = Tantalum
TI = Titanium

See page 9 for material compatibility codes.

Material compatibility for Coriolis meters *continued*

Fluid name	Temp. (°C)		Conc. (%wt)		Material compatibility					Notes
	Low	High	Low	High	SS	C22	TZ	TA	TI	
Sodium Carbonate/Sulfuric Acid					O	O	X	O	–	
Sodium Chlorate	0	104	0	70	X	O	O	O	O	
Sodium Chlorate	60	150	70	100	X	O	O	O	O	
Sodium Chloride	0	60	0	100	X	O	O	O	O	
Sodium Cyanide	0	38	0	10	O	O	O	–	O	
Sodium Cyanide	0	120	0	100	X	X	O	–	–	
Sodium Formaldehyde					O	O	–	O	–	
Sodium Formaldehyde Bisulfate					O	O	–	O	–	
Sodium Formaldehyde sulfoxylate					–	O	–	O	–	
Sodium Gluconate					O	O	–	–	–	
Sodium Hydrosulfate					O	O	–	–	–	
Sodium Hydrosulfide					X	–	–	O	–	
Sodium Hydrosulfide					–	O	–	O	–	
Sodium Hydrosulfite					O	O	–	O	–	
Sodium Hydroxide ⁽¹⁾	0	53	0	15	O	O	O	X	O	Observe chloride limits of Fig 2
Sodium Hydroxide ⁽¹⁾	0	53	15	20	O	O	O	X	X	Observe chloride limits of Fig 2
Sodium Hydroxide ⁽¹⁾	0	53	20	50	X	O	O	X	X	Observe chloride limits of Fig 2
Sodium Hydroxide ⁽¹⁾	53	86	0	50	X	O	O	X	X	Observe chloride limits of Fig 2
Sodium Hydroxide ⁽¹⁾	86	120	0	100	X	X	O	X	X	Observe chloride limits of Fig 2
Sodium Hypochlorite	0	30	0	1	O	O	O	O	O	
Sodium Hypochlorite	30	60	0	16	X	O	O	O	O	
Sodium Hypochlorite	60	120	0	16	X	X	O	O	–	
Sodium Hypophosphite					O	O	O	O	–	
Sodium Metabisulfite					–	O	O	–	–	
Sodium Metal					X	O	X	O	–	
Sodium Nitrate	0	112	0	60	O	O	O	O	O	
Sodium Nitrate	0	120	60	100	–	–	O	–	O	
Sodium Nitrite					X	O	O	O	O	
Sodium Omandine					X	–	–	–	–	
Sodium Perchlorate	0	65	0	100	–	O	O	O	–	
Sodium Persulfate					–	O	–	O	–	
Sodium Phenolate	0	120	0	100	–	O	O	O	–	
Sodium Phosphate	0	100			X	O	O	O	O	
Sodium Polyphosphate					–	O	O	–	–	
Sodium Silicate					O	O	O	O	O	
Sodium Sulfate	0	100	0	20	O	O	O	O	O	
Sodium Sulfide	0	120	0	50	X	O	O	O	O	
Sodium Sulfite	0	120	0	10	X	O	O	O	O	

SS = Stainless steel
C22 = Nickel alloy C22

TZ = Tefzel-lined 316L
TA = Tantalum
TI = Titanium

See page 9 for material compatibility codes.

(1) Refer to page 33 for additional information about NaOH.

Material compatibility for Coriolis meters *continued*

Fluid name	Temp. (°C)		Conc. (%wt)		Material compatibility					Notes
	Low	High	Low	High	SS	C22	TZ	TA	TI	
Sodium Xylene Sulphonate					O	O	-	O	-	
Soy Oil					O	O	O	O	O	
Soy Protein			0	18	-	O	O	O	O	
Soy Sauce					X	O	O	O	O	
Spent Acid					X	X	O	O	-	
Stannic Chloride					X	O	X	O	O	
Stannous Chloride	0	75	0	10	O	O	O	O	O	
Stannous Chloride	0	120	10	100	X	O	O	O	-	
Starch Syrup					O	O	O	O	-	
Stearic Acid					O	O	O	O	O	
Styrene					O	O	O	O	-	
Sucrose	0	93	0	62	O	O	O	O	-	
Sulfamic Acid	0	30			O	O	O	O	X	
Sulfite Liquor					X	O	O	X	O	
Sulfolane					O	O	O	O	-	
Sulfonic Acid					C	O	-	-	-	
Sulfonylchloride					X	O	-	O	-	
Sulfur	0	120	0	100	O	O	O	O	O	Molten
Sulfur Dichloride					X	O	O	O	-	
Sulfur Dioxide					O	O	X	O	O	Anhydrous
Sulfur Dioxide					X	O	X	O	X	Wet
Sulfur Monochloride/Isobutylene					X	-	-	O	-	
Sulfur Trioxide	0	25	0	100	-	O	O	X	X	
Sulfuric Acid ⁽¹⁾	-18	24	0	20	O	O	O	O	X	Maintain Velocity < 10 ft/sec
Sulfuric Acid ⁽¹⁾	-18	24	20	65	X	O	O	O	X	Maintain Velocity < 10 ft/sec
Sulfuric Acid ⁽¹⁾	-18	24	65	75	X	X	O	O	X	Maintain Velocity < 10 ft/sec
Sulfuric Acid ⁽¹⁾	-18	24	75	98	C	O	O	O	X	Maintain Velocity < 5 ft/sec
Sulfuric Acid ⁽¹⁾	24	38	0	10	O	O	O	O	X	Maintain Velocity < 10 ft/sec
Sulfuric Acid ⁽¹⁾	24	38	10	40	X	O	O	O	X	Maintain Velocity < 10 ft/sec
Sulfuric Acid ⁽¹⁾	24	38	40	75	X	X	O	O	X	Maintain Velocity < 10 ft/sec
Sulfuric Acid ⁽¹⁾	24	38	75	85	-	-	O	O	X	Maintain Velocity < 4 ft/sec
Sulfuric Acid ⁽¹⁾	24	38	85	93	-	O	O	O	X	Maintain Velocity < 10 ft/sec
Sulfuric Acid ⁽¹⁾	24	38	93	98	O	O	O	O	X	Maintain Velocity < 10 ft/sec
Sulfuric Acid ⁽¹⁾	38	52	0	5	O	O	O	O	X	Maintain Velocity < 10 ft/sec
Sulfuric Acid ⁽¹⁾	38	52	5	25	X	O	O	O	X	Maintain Velocity < 10 ft/sec
Sulfuric Acid ⁽¹⁾	38	52	25	75	X	X	O	O	X	Maintain Velocity < 10 ft/sec
Sulfuric Acid ⁽¹⁾	38	52	75	90	-	-	O	O	X	Maintain Velocity < 3 ft/sec
Sulfuric Acid ⁽¹⁾	38	52	90	98	-	O	O	O	X	Maintain Velocity < 10 ft/sec

SS = Stainless steel
C22 = Nickel alloy C22

TZ = Tefzel-lined 316L
TA = Tantalum
TI = Titanium

See page 9 for material compatibility codes.

(1) Refer to page 34 for additional information about H₂SO₄.

Material compatibility for Coriolis meters *continued*

Fluid name	Temp. (°C)		Conc. (%wt)		Material compatibility					Notes
	Low	High	Low	High	SS	C22	TZ	TA	TI	
Sulfuric Acid ⁽¹⁾	52	54	0	5	X	O	O	O	X	Maintain Velocity < 10 ft/sec
Sulfuric Acid ⁽¹⁾	52	54	5	75	X	X	O	O	X	Maintain Velocity < 10 ft/sec
Sulfuric Acid ⁽¹⁾	52	54	75	98	-	-	O	O	X	Maintain Velocity < 2 ft/sec
Sulfuric Acid ⁽¹⁾	54	66	0	5	X	O	O	X	X	Maintain Velocity < 10 ft/sec
Sulfuric Acid ⁽¹⁾	54	66	5	98	X	X	O	X	X	Maintain Velocity < 10 ft/sec
Sulfuric Acid ⁽¹⁾	66	93	0	50	X	X	O	X	X	Maintain Velocity < 10 ft/sec
Sulfuric Acid ⁽¹⁾	66	93	50	98	X	X	O	X	X	Maintain Velocity < 10 ft/sec
Sulfuric Acid ⁽¹⁾	93	204	0	98	X	X	X	X	X	Maintain Velocity < 10 ft/sec
Sulfuric Fluoride					X	-	O	-	-	
Sulfuryl Chloride					X	O	O	O	-	
Sulphenilic Acid					O	O	-	-	-	
Sulphurous Acid					X	O	O	O	-	
Tall Oil Fatty Acid					-	O	-	-	-	
Tall Oil Rosin					-	O	X	O	-	
Tall Oil Soap					X	O	O	X	-	
Tar	150	200			O	O	X	O	X	
Tar Acid	0	200	0	100	X	O	X	O	-	
Tea					O	O	O	O	O	
Terephthalic Acid	100	160	0	100	O	O	X	O	-	
Tetrachloroethane	0	70	0	100	X	O	O	O	O	
Tetrachloroethylene Sulfide					X	O	-	-	-	
Tetrachlorosilane					X	O	-	O	-	
Tetrafluoroethane					O	O	O	-	-	Anhydrous
Tetrahydrofluorine					-	-	O	-	-	
Tetrahydrofuran					O	O	X	-	X	
Tetrasodium EDTA					O	O	-	-	-	
Thinner					O	O	-	O	O	
Thiodichloric Acid					X	O	-	O	-	
Tin Liquor					X	O	X	O	-	
Titanium Chloride					X	O	O	O	O	
Titanium Dioxide					O	O	O	O	O	
Titanium Iron Sulfate Solution					-	-	O	-	-	
Titanium Tetrachloride					X	O	O	O	O	
Toluene					O	O	O	O	O	
Toluene Diisocyanate					O	O	-	O	-	
Toluenesulfonic Acid	0	125	0	94	C	O	X	O	-	
Tomato Paste					O	O	O	-	-	
Triacetin					O	O	-	-	-	

SS = Stainless steel
C22 = Nickel alloy C22

TZ = Tefzel-lined 316L
TA = Tantalum
TI = Titanium

See page 9 for material compatibility codes.

(1) Refer to page 34 for additional information about H₂SO₄.

Material compatibility for Coriolis meters *continued*

Fluid name	Temp. (°C)		Conc. (%wt)		Material compatibility					Notes
	Low	High	Low	High	SS	C22	TZ	TA	TI	
Tribromomethane					X	–	O	O	–	
Trichloroacetic Acid	0	120	0	50	X	O	O	O	X	
Trichloroacetyl Chloride					X	O	–	O	–	
Trichlorobenzene					X	O	O	O	–	
Trichlorobromomethane					X	–	O	O	–	
Trichloroethane					X	X	X	O	O	
Trichloroethylene					O	O	–	O	O	Anhydrous
Trichloromethylpyridine					X	O	–	O	–	
Trichloromonofluoroethane					O	O	–	–	–	
Trichlorosilane					O	O	–	O	–	
Trichlorotrifluoroethane					O	O	O	–	X	
Triethanolamine	0	95	0	100	O	O	O	–	O	
Triethyl Aluminum					O	O	–	O	X	
Triethylamine					O	O	–	O	–	
Triethylene Glycol					O	O	X	O	O	
Trifluoroacetic Acid					X	O	X	–	–	
Trimethyl Sulfonium Bromide					X	–	–	O	–	
Trimethylchlorocyanate					X	O	O	O	–	
Triphenyl Phosphite					O	O	X	O	O	
Trisodiumphosphate	0	200	0	90	X	O	X	O	–	
Tritylchloride					X	O	–	O	–	
Turpentine					O	O	O	O	X	
Urea	0	90	0	100	O	O	O	O	O	
Vanadium Benzene					O	O	–	–	–	
Vanadium Chloride					X	O	O	O	–	
Vanadium Oxychloride					X	O	–	O	–	
Vanadium Oxytrichloride					X	O	O	O	–	
Vanadium Tetrachloride					X	O	O	O	–	
Vanadium Triacetylacetonate					X	O	X	O	–	
Varnish					O	O	O	O	–	
Vazo					X	O	–	–	–	
Vegetable Tanning Liquor	0	79	0	100	–	O	O	O	–	
Vinegar					O	O	X	O	O	
Vinyl Acetate					O	O	O	–	O	
Vinyl Acetate Polymer Residues					O	O	–	–	–	
Vinyl Chloride	0	60	0	100	–	O	O	O	O	Latex
Vinyl Chloride	0	65	0	100	O	O	O	O	O	Monomer
Vinyl Fluoride					–	–	O	–	–	
Vinylidene Chloride					X	O	O	O	–	
Vitamin E					O	O	–	–	–	

SS = Stainless steel
C22 = Nickel alloy C22

TZ = Tefzel-lined 316L
TA = Tantalum
TI = Titanium

See page 9 for material compatibility codes.

Material compatibility for Coriolis meters *continued*

Fluid name	Temp. (°C)		Conc. (%wt)		Material compatibility					Notes
	Low	High	Low	High	SS	C22	TZ	TA	TI	
Water	0	200	0	100	O	O	O	O	O	Observe chloride limits of Fig 2
Water/Flour/Starch/Corn Syrup					-	O	O	O	O	
Wax Emulsion					O	O	O	-	O	
Whey/Milk					O	O	O	O	O	
Whisky					O	O	O	O	O	
White Liquor	20	50	0	100	X	O	O	X	-	
Wine					O	O	O	O	O	
Xylene	20	120	0	100	O	O	O	O	O	
Yeast					O	O	-	-	-	
Yogurt					O	O	O	O	-	
Zeolite					-	O	O	-	-	
Zinc Carbonate Slurry	0	21	0	100	-	O	O	O	-	
Zinc Carbonate Slurry	21	82	0	100	-	O	O	O	-	
Zinc Chloride	0	107	0	71	X	O	O	O	O	
Zinc Dialkyl Dithiophosphate					X	O	-	O	-	
Zinc Hydrosulfite	0	120	0	10	X	O	O	O	-	
Zinc Sulfate	0	111	0	34	X	O	O	O	O	
Zirconium Chloride	0	85	0	25	X	O	O	O	-	
Zirconium Chloride					X	O	X	O	-	Gas

SS = Stainless steel
C22 = Nickel alloy C22

TZ = Tefzel-lined 316L
TA = Tantalum
TI = Titanium

See page 9 for material compatibility codes.

Application notes

Hydrochloric acid (HCl)

Hydrochloric acid is reducing in a 1% to 37% concentration range. The strong acidic character, combined with the presence of chlorine, makes hydrochloric acid a very severe corrosive. High nickel alloys and tantalum are two of the few materials having useful resistance in this environment. Nickel-based alloys are not resistant over about 18% at 85 °F (29 °C). At higher

concentrations or higher temperatures, corrosion fatigue failure is expected due to loss of passivity and corrosion in the active field. Corrosion of nickel alloy C22 meters is definitely expected in the 19% to 37% concentration range under ambient temperature conditions. Tantalum is the recommended material for higher concentrations.

Application notes *continued*

Sodium hydroxide (NaOH)

Sodium hydroxide is a strong base used in many industries to control pH or as a cleaning compound. In recent years, the production methods of this versatile compound have greatly reduced the amount of chlorine present in the raw product. This change has allowed the use of stainless steel in applications where it was previously avoided. Sodium hydroxide is usually not a problem from a general corrosion perspective but has been known to cause stress corrosion cracking of stainless steels at elevated temperatures. A close relationship between stress corrosion cracking and corrosion fatigue is generally recognized. This implies that if stress corrosion cracking occurs, corrosion fatigue is also possible depending upon the stress state resulting from applied loads. It is also known through experience that sodium hydroxide is often mixed with water containing chlorine. The presence of chlorine may be a more dominant factor dictating meter life than the concentration or temperature of the sodium hydroxide alone.

Experimental work has been conducted in 50% NaOH and a 50% NaOH solution to which 2.5% Cl^- has been added. Electrochemical and corrosion fatigue data have been collected on 316L samples exposed to such an environment. Failure of stainless steel meters exposed to the pure 50% solution was not observed after 4 months of exposure. Metallographic analysis showed no indication of stress corrosion cracking or localized corrosion. A second group of meters exposed to solutions containing the chloride ion failed via corrosion fatigue after 4 days of exposure. The temperature in all cases was 200 °F (93 °C). Electrochemical tests in these environments indicated the presence of an oxide

layer on 316L surfaces. The passive current density, which is an inverse measure of oxide layer thickness, was 25 times higher when the chloride ion was present. The higher current density indicates that the chloride ion will substantially thin the oxide layer, resulting in a higher susceptibility to mechanical damage. This, in turn, would explain the dramatically lower life shown in corrosion fatigue tests.

Stress corrosion cracking, or corrosion fatigue, is not expected in stainless steel meters exposed to “pure” sodium hydroxide solutions where the concentration is less than 50% by weight and the temperature is 200 °F (93 °C) or lower. Higher concentration, and especially higher temperature, could cause failure. Nickel alloy C22 is recommended under these conditions. Nickel-based alloys (such as nickel alloy C22) should be resistant at all concentrations of sodium hydroxide up to the boiling point of the solution. The presence of the chloride ion can be very detrimental to 316L meter life. If the presence of chlorine is a possibility, nickel alloy C22 should be used over stainless steel.

Sodium hydroxide is also used as the basic component in many standard clean-in-place (CIP) solutions. These solutions, typically found in food and beverage applications and the life sciences industry, have two components. The first component, depending on the pH of the process fluid, will be either a base (such as sodium hydroxide) or an acid (such as nitric acid). In either case, both solutions are flushed through the meter for varying periods of time and at typically elevated temperatures. In general, these solutions are designed and have been used with success on process streams constructed with stainless steel (316L or 304L). Recently, the introduction of titanium to the aforementioned industries has raised concerns regarding compatibility. In many cases, titanium is more corrosion resistant than stainless steel. However, with strong bases, where

Application notes *continued*

the protective oxide film has a difficult time regenerating, the titanium can be more susceptible to attack. This attack is general in nature, in that it attacks the entire tube in a uniform manner. This corrosion guide has been updated to reflect both new information and field experience regarding sodium hydroxide. It is vital, however, that all process fluids passing through a meter be considered when assessing an application.

Nitric acid (HNO₃)

General corrosion in nitric acid, being a strong oxidizing acid, is best withstood by alloys which form stable adhering oxide films. In general, high chromium-containing alloys and strongly passivating metals like tantalum are the most resistant.

The most commonly used material for the storage of nitric acid is 304L stainless steel. The corrosion resistance of 304L is often slightly better than 316L, which contains molybdenum.

Corrosion rates increase with higher temperatures and concentrations. Intergranular corrosion can occur when stainless steels or nickel alloys are sensitized, which means they contain precipitated carbides. Low carbon grades like 316L and 304L are normally not susceptible to intergranular corrosion.

However, intergranular corrosion can also occur, regardless of heat treatment or composition of the alloy, if hexavalent chromium ions are allowed to accumulate in the acid to some critical concentration.

Titanium is not compatible with red fuming nitric acid at any temperature.

Sulfuric acid (H₂SO₄)

The purpose of this technical note is to assist the customer in making the correct material decision for a Micro Motion Coriolis meter in sulfuric acid applications. As always, the final choice for meter material is left to the customer.

Micro Motion's Tefzel-lined meter will provide excellent service in sulfuric acid applications over all concentration ranges up to 98% and at temperatures up to 200 °F (93 °C). However, if the process stream encounters changes in temperature at a rate greater than 30 °F (17 °C) per hour, a 316L stainless steel or nickel-based alloy meter is a better choice. 316L stainless steel meters are best suited for low temperatures at both low and high concentrations of sulfuric acid. Nickel-based alloy meters can be used at slightly higher temperatures and over a broader temperature range.

316L stainless steel and nickel-based alloys depend on electrochemical passivity for resistance to corrosion in sulfuric acid. Electrochemical passivity refers to the state of the material's protective oxide layer. The material's protective oxide layer can be considered to exist in one of three states: the passive state, the active state, and the transpassive state. In the passive state, the oxide layer is highly stable and provides the material's excellent corrosion resistance. The active state refers to a condition where the oxide layer is less stable. In the active state, the removal of the oxide layer can expose the more susceptible base metal. The transpassive state is similar to the active state in that the oxide layer is again less stable. To maximize meter life it is important to maintain the oxide layer in the passive state. However, exposure to sulfuric acid under varying conditions can cause the passive or stable oxide layer to become active or less stable.

Application notes *continued*

When making the decision to place a 316L stainless steel or nickel-based alloy meter in a sulfuric acid application, all of the following variables need to be considered to make the correct material choice. Each of the following factors can have an effect on the stability of the protective oxide layer.

Concentration

Sulfuric acid is somewhat oxidizing and not very aggressive at dilute concentrations up to about 10–15%. As concentration increases into the intermediate range, sulfuric acid becomes reducing and considerably more aggressive. You should notice that we do not recommend 316L stainless steel in the intermediate concentration ranges of sulfuric acid. However, nickel alloy C22 is more resilient in mildly reducing environments, and find some applicability in the intermediate concentration range. Further increases in the concentration range above 75% push sulfuric acid into the oxidizing region, and its ability to attack the protective oxide layer is reduced with increasing concentration.

Temperature

The temperature of the process stream has a great effect on the stability of the oxide layer. As temperature increases, the margin between an active and passive oxide layer becomes less. For any application in sulfuric acid, lowering the temperature will enhance the stability of the oxide layer.

Velocity

Many articles refer to the apparent erosion by sulfuric acid. However, there are not any truly erosive constituents in most sulfuric acid process streams. So one might ask the question, “Why did my pipe erode away in the sulfuric acid application?” The answer lies with the oxide layer. Sulfuric acid in the higher concentration range can cause an unexpected oscillation in the oxide layer from passive to active to passive (and so on).

When the oxide layer is in the less stable active state, the acid can pull the layer into the process stream before it can make the transition back to the more stable passive state. This results in a passive layer forming, becoming active, and being stripped away, then another passive layer forms and the cycle repeats. This gradual loss of material appears to be erosion.

Figure 7. Maximum recommended fluid velocity

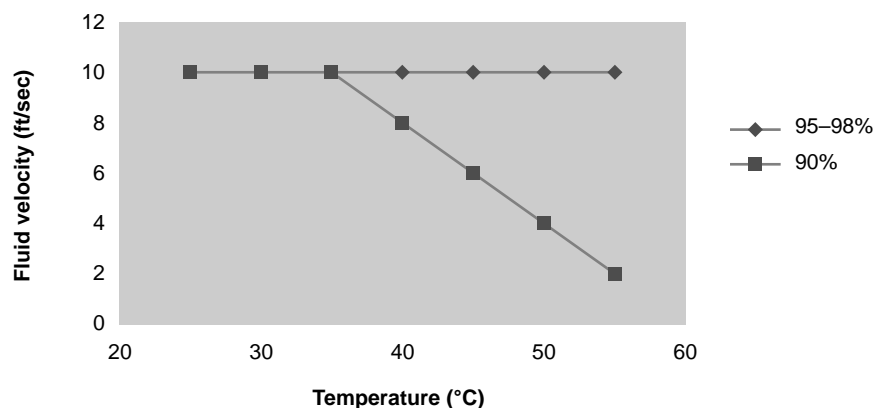

Application notes *continued*

It has been shown that reducing the fluid velocity can lessen the likelihood of the active oxide layer being removed from the material surface. Figure 7 provides a general guideline for maximum fluid velocity at different concentrations and temperatures.

The velocity recommendation was constructed primarily from the data for 316L stainless steel. However, it is felt that nickel-based alloy applications could benefit from adhering to this recommendation. Lastly, it should be noted that the 75%–90% concentration range is not covered in the velocity recommendation. This is due to a lack of data. Based on the relative aggressiveness of sulfuric acid in the 75%–90% range, it is recommended that the fluid velocity be maintained as low as possible.

Other factors

Aeration of the sulfuric acid solution can help enhance the stability of the passive oxide layer in both 316L stainless steel and nickel-based alloys.

The existence of oxidizing impurities such as Fe⁺⁺⁺ (ferric), Cu⁺⁺ (cupric), Sn⁺⁺⁺⁺ (stannic), or Ce⁺⁺⁺⁺ (ceric) ions in the process stream acts to stabilize the passive film. In concentrations of sulfuric acid above 97%, the presence of SO₃ (sulfite) can also add stability to the passive film. However, the presence of halides in sulfuric acid (such as chlorides) can have a detrimental effect on the stability of the oxide layer.

Summary

Material recommendations for sulfuric acid applications are at best difficult. Applications which appear to be very similar can have drastically different electrochemical properties. History is the best source of information to use when making material compatibility decisions. For newer applications, or applications where the risk of fluid release is to be minimized, Micro Motion ELITE[®] meters have excellent turndown characteristics, can be sized to reduce fluid velocity in the sensor.

Density and viscosity meters

Micro Motion manufactures fork density and viscosity meters in a variety of wetted materials including 316L and 304L stainless steels, nickel alloys C22, B3, and alloy 400, titanium, and zirconium (zirconium is available only for fork density meters). Tube density meters are offered in 316L, nickel alloy C22, and Ni-Span-C[®] Alloy 902, and gas density and specific gravity meters utilize Ni-Span-C Alloy 902 as the choice wetted material.

Although some of the previously-provided text information regarding Coriolis meters may indirectly apply to Density and viscosity meters, the specific material compatibility recommendations can vary greatly. It is for this reason that a separate section of this corrosion guide has been created for Density and viscosity meters.

Density and viscosity meters *continued*

Material compatibility variables

Material compatibility must be considered in more detail for tube density meters as compared to fork density and viscosity meters or piping or tanks. Material compatibility cannot always be assessed by considering the alloy(s) selected for the remainder of the piping/tank system. Tube density meters require vibration of a wetted tube to calculate a density measurement. This cyclic loading condition is inherent to all tube density meters and must be considered in the material selection process.

Alloy B3 and alloy 400 are susceptible to corrosion in certain applications containing oxidizing impurities such as ferric ions (Fe^{+3}) and cupric ions (Cu^{+2}). Zirconium can succumb to pitting and intergranular corrosion when these impurities are present in certain concentrations of hydrochloric acid (HCl) solutions. The material compatibility tables attempt to address these concerns where possible, but care should always be taken when oxidizing impurities are known to be present in an application.

Gas density (Model 7812) and gas specific gravity (Model 3098) meters

The Model 7812 and 3098 meters are not listed in the material compatibility tables. Instead, general recommendations will be provided in this section.

Process gases must be dry (above their dew point), clean, and compatible with Ni-Span-C Alloy 902 and 316L stainless steel. Ideal gases include natural gas, hydrogen, methane, propane, etc. Heat may be applied and/or a coalescing filter may be installed in some applications to reduce the presence of liquids that can damage the 7812 and 3098 meters.

Model 3098 meters can be used in refinery and fuel gas applications, although fluids with the molecular weight of pentane and higher are generally in liquid form and will have to be removed from the process stream by equipment used for liquid removal.

Model 3098 meters are generally not recommended for use with hydrogen sulfide (H_2S), but they have been used in applications with low concentrations of H_2S in which all of the water/moisture has been removed.

The pressure-containing components of Model 7812 meters are NACE compliant. Low concentrations of hydrogen sulfide (H_2S) are permitted (less than 1000 ppm), provided the process gas is clean and dry. A coalescing filter is recommended to be installed into the process line of the 7812 meter.

Utilizing a Model 7812 or 3098 meter in sour gas (hydrogen sulfide-containing) wells in exploration and production applications is generally not successful.

Please contact Micro Motion with any application questions.

How to use the material compatibility tables for Density and viscosity meters

The tube density meter material compatibility table begins on page 39, and the fork density and viscosity meter material compatibility table begins on page 62. The information on this page is provided to assist in the interpretation of those tables.

Fluids

Fluids are listed alphabetically and are generally listed under the appropriate chemical names, not trade names. The synonyms section on page 92 provides a means to reference trade names and other commonly-used synonyms with the chemical names used in this corrosion guide. All fluids and flow conditions must be considered when making material selections. This includes the primary fluid, contaminants, cleaning fluids, and any other chemical solutions.

Temperature and concentration

Each chemical may have one or more temperature and concentration combinations that define the environment to which the particular material was subjected. Temperature variation must be taken into account. In general, lower temperatures reduce the possibility of localized attack. This rule does not necessarily apply for variations in concentration. It is equally possible for a low or high concentration to cause corrosion. Evaporation of a fluid can result in elevated concentration of components, which can lead to corrosion. This situation may be prevented by completely flushing the meter of any residual corrosive.

Materials

Compatibility of 316L and 304L stainless steels, nickel alloys C22, B3, and alloy 400, titanium, and zirconium (available only for fork density meters), and Ni-Span-C Alloy 902 are displayed in the material compatibility columns. To simplify interpretation, four symbols have been used. A blank entry indicates that the material/fluid combination has not yet been researched for use with Micro Motion Density or viscosity products:

- X The selected material is not compatible with the environment
- O The selected material is compatible with the environment
- No data available
- C Conflicting data

Note:

Corrosion data is not always available for the full temperature range of the meter. Materials will normally maintain corrosion resistance at temperatures below the lower limits in the table. Contact Micro Motion if your process might exceed the maximum temperature limits listed in the table for a particular application. Where temperature ranges have been omitted from the table, corrosion resistance is believed to be maintained throughout the temperature range of the meter. For applications that do not appear in this corrosion guide, please contact Micro Motion.

Material compatibility for tube density meters

Fluid name	Temp (°C)		Conc. (%wt)		Compatibility			Notes
	Low	High	Low	High	SS	C22	NSC	
Acetaldehyde	-18	93	0	100	O	O		
Acetaldehyde	93	149	0	100	-	-		
Acetate	-18	52	0	100	O	O		
Acetate	52	77	0	100	O	O		
Acetate	77	100	0	100	O	O		
Acetate	100	204	0	100	O	O		
Acetic Acid	-18	10	0	50	O	O		
Acetic Acid	-18	10	50	80	O	O		
Acetic Acid	-18	10	80	95	-	O		
Acetic Acid	-18	10	95	100	O	O		
Acetic Acid	10	71	0	50	O	O		
Acetic Acid	10	71	50	80	O	O		
Acetic Acid	10	71	80	95	X	O	X	
Acetic Acid	10	66	95	100	O	O		
Acetic Acid	66	93	95	100	O	O		
Acetic Acid	71	79	0	45	O	O		
Acetic Acid	71	79	45	50	C	O		
Acetic Acid	71	79	50	80	-	O		
Acetic Acid	79	93	0	45	O	O		
Acetic Acid	79	93	45	50	C	O		
Acetic Acid	79	93	50	55	-	O		
Acetic Acid	79	93	55	95	X	O	X	
Acetic Acid	93	99	0	20	O	O		
Acetic Acid	93	99	20	50	C	O		
Acetic Acid	93	99	50	55	-	O		
Acetic Acid	93	99	55	80	X	O	X	
Acetic Acid	93	99	80	95	X	X	X	
Acetic Acid	93	118	95	100	X	O	X	
Acetic Acid	99	104	0	20	O	O		
Acetic Acid	99	104	20	50	C	X		
Acetic Acid	99	104	50	55	-	X		
Acetic Acid	99	104	55	80	X	X	X	
Acetic Acid	99	104	80	95	X	X	X	
Acetic Acid	104	127	0	20	O	O		
Acetic Acid	104	127	20	50	C	X		
Acetic Acid	104	127	50	55	-	X		
Acetic Acid	104	127	50	80	X	X	X	
Acetic Acid	104	127	80	85	X	X	X	
Acetic Acid	104	127	85	95	X	X	X	
Acetic Acid	118	204	95	100	X	O	X	
Acetic Acid	127	135	0	20	O	O		
Acetic Acid	127	135	20	50	C	X		

SS = Stainless steel
 NSC = Ni-Span-C Alloy 902
 C22 = Nickel alloy C22

See page 38 for material compatibility codes.

Material compatibility for tube density meters *continued*

Fluid name	Temp (°C)		Conc. (%wt)		Compatibility			Notes
	Low	High	Low	High	SS	C22	NSC	
Acetic Acid	127	135	50	55	–	X		
Acetic Acid	127	135	50	85	X	X	X	
Acetic Acid	127	135	85	95	X	X	X	
Acetic Acid	135	149	0	20	O	O		
Acetic Acid	135	149	20	50	C	X		
Acetic Acid	135	149	50	55	–	X		
Acetic Acid	135	149	55	95	X	X	X	
Acetic Acid	149	204	0	20	O	–		
Acetic Acid	149	204	20	50	C	X		
Acetic Acid	149	204	50	55	–	X		
Acetic Acid	149	204	55	95	X	X	X	
Acetic Anhydride	–18	38	0	100	X	O	X	
Acetic Anhydride	38	121	0	100	X	O	X	
Acetic Anhydride	121	143	0	100	X	O	X	
Acetone	–18	60	0	100	O	O		
Acetone	60	93	0	100	O	O		
Acetone	93	104	0	100	O	O		
Acetone	104	149	0	100	O	–		
Acetone	149	204	0	100	O	–		
Acetone Cyanhydrin					O	–		
Acetone, 50% Water	–18	60	0	100	X	O	X	
Acetone, 50% Water	60	104	0	100	X	O	X	
Acetonitrile	0	60	0	100	O	–		
Acetyl Chloride	–18	21	0	100	O	O		
Acetyl Chloride	21	37	0	100	X	O	X	
Acetyl Chloride	37	60	0	100	X	–	X	
Acetylene	0	26	0	100	O	O		
Acetylene	26	37	0	100	O	O		
Acetylene	37	116	0	100	O	–		
Acetylene	116	204	0	100	O	–		
Acetylene Tetrabromide					X	–	X	
Acetylene Trichloride	0	106	0	90	X	O	X	
Acid Pulping	0	80	0	100	X	O	X	
Acrylic Acid	0	53			O	O		
Acrylic Emulsion					O	O		
Acrylonitrile	0	60	0	100	O	O		
Acrylonitrile	60	87	0	100	O	O		
Acrylonitrile	87	104	0	100	X	O	X	
Acrylonitrile	104	130	0	100	–	–		
Adipic Acid	0	10	0	100	O	O		

SS = Stainless steel
 NSC = Ni-Span-C Alloy 902
 C22 = Nickel alloy C22

See page 38 for material compatibility codes.

Material compatibility for tube density meters *continued*

Fluid name	Temp (°C)		Conc. (%wt)		Compatibility			Notes
	Low	High	Low	High	SS	C22	NSC	
Adipic Acid	10	93	0	100	O	O		
Adipic Acid	93	120	0	100	X	–	X	
Adipic Acid	120	220	0	100	X	–	X	
Air					O	O		
Alachlor Technical					–	O		Chlorodiethylacetanilide
Alcohols	0	100	0	100	O	O	O	
Alkaline Liquor					O	O		
Alkylbenzene Sulfonic Acid					–	O		
Alkyldimethyl Ammonium Chloride					X	O	X	
Allyl Alcohol	0	93	0	100	O	O		
Allyl Alcohol	93	209	0	100	O	X		
Allyl Chloride	0	26	0	100	O	O		
Allyl Chloride	26	82	0	100	X	X	X	
Allyl Chloride Phenol					X	O	X	
Allyl Chloroformate					X	O	X	
Allyl Phenol	0	130	0	100	O	–		
Allylbenzene	20	60	0	100	O	–		
Alphamethylstyrene					O	O		
Alum	0	30	0	100	O	O		
Alum	30	98	0	100	–	X		
Alum	98	120	0	100	–	–		
Alumina					O	O		
Aluminum Chloride Aqueous	0	93	0	10	X	O	X	
Aluminum Chloride Aqueous	0	93	10	100	X	O	X	
Aluminum Chloride Aqueous	93	120	0	100	X	–	X	
Aluminum Chloride Dry	0	93	0	100	X	O	X	
Aluminum Chloride Dry	93	120	0	100	X	–	X	
Aluminum Chlorohydroxide					X	O	X	
Aluminum Fluorosulfate	0	200	0	15	–	O		
Aluminum Nitrate	0	98	0	100	O	–		
Aluminum Nitrate	98	120	0	100	X	–	X	
Aluminum Oxide					O	O		
Aluminum Silicate					–	–		
Aluminum Sulfate	0	38	0	100	X	O	X	
Aluminum Sulfate	38	93	0	100	X	–	X	
Amine	0	100	0	100	O	O		
Amine	100	120	0	100	X	X	X	
Amine	120	148	0	100	–	–		
Ammonia	0	30	0	50	O	O		
Ammonia	30	70	0	30	O	O		

SS = Stainless steel
 NSC = Ni-Span-C Alloy 902
 C22 = Nickel alloy C22

See page 38 for material compatibility codes.

Material compatibility for tube density meters *continued*

Fluid name	Temp (°C)		Conc. (%wt)		Compatibility			Notes
	Low	High	Low	High	SS	C22	NSC	
Ammonia	30	70	30	50	X	O	X	
Ammonia	70	150	0	50	X	O	X	
Ammonia Anhydrous					O	O		
Ammonium Carbonate	0	20	0	30	O	O		
Ammonium Carbonate	20	93	0	30	O	X		
Ammonium Carbonate	93	120	0	30	X	–	X	
Ammonium Chloride	0	93	0	10	X	O	X	
Ammonium Chloride	0	82	0	50	X	O	X	
Ammonium Chloride	82	104	0	50	X	–	X	
Ammonium Chloride	104	120	0	50	X	–	X	
Ammonium Dihydrozene Phosphate					–	O		
Ammonium Laurate					O	–		
Ammonium Laureth Sulfate					–	O		
Ammonium Nitrate	0	93	0	100	O	O		
Ammonium Nitrate	93	120	0	100	O	C		
Ammonium Oxalate	0	24	0	10	X	O	X	
Ammonium Persulfate	0	25	0	5	O	O		
Ammonium Persulfate	0	25	5	10	O	O		
Ammonium Persulfate	0	60	10	100	O	–		
Ammonium Persulfate	60	120	10	100	–	–		
Ammonium Phosphate	0	60	0	10	O	O	O	
Ammonium Phosphate	0	60	10	100	X	O	X	
Ammonium Phosphate	60	104	0	10	X	X	X	
Ammonium Phosphate	60	120	10	100	–	–	X	
Ammonium Phosphate	104	120	0	10	–	–	X	
Ammonium Phosphate	120	148	10	100	–	–	X	
Ammonium Saltwater	20	80	0	15	X	O	X	
Ammonium Sulfate	0	104	0	10	X	O	X	
Ammonium Sulfate	0	120	10	100	X	X	X	
Ammonium Sulfate	104	120	0	10	X	X	X	
Ammonium Sulfate	120	160	0	10	–	–		
Ammonium Sulfate	120	149	10	100	–	–		
Ammonium Sulfide	0	70	0	100	–	O		
Ammonium Sulfide	40	60	0	100	–	O		
Ammonium Thioglycolate					O	O		
Ammonium Thiosulfate					–	O		
Amyl Chloride	0	60	0	100	O	O		
Amyl Chloride	60	120	0	100	–	–		
Amyl Chloride	120	148	0	100	–	–		
Amyl Mercaptan	0	160	0	100	–	O		

SS = Stainless steel
 NSC = Ni-Span-C Alloy 902
 C22 = Nickel alloy C22

See page 38 for material compatibility codes.

Material compatibility for tube density meters *continued*

Fluid name	Temp (°C)		Conc. (%wt)		Compatibility			Notes
	Low	High	Low	High	SS	C22	NSC	
Amylphenol	0	200	0	100	–	O		
Aniline	0	110	0	100	O	O		
Aniline	110	120	0	100	O	O		
Aniline	120	265	0	100	O	–		
Animal Fat					–	O		
Anodizing Solution Aluminum					–	O		
Anthracene Oil	80	90	0	100	O	–		
Anthraquinone					–	–		
Antibiotic Fermentation Media					–	O		
Antimony Pentachloride	0	71	0	50	X	O	X	
Apple Juice					O	O		
Aqua Quinine					O	O		
Aqua Regia	0	20	0	75	X	X	X	
Aqua Regia	20	82	0	75	X	X	X	
Argon					O	O		
Arsenic Acid	0	52	0	100	O	X		
Arsenic Acid	52	120	0	100	X	–	X	
Asphalt	0	60	0	100	O	–		
Asphalt	60	200	0	100	O	–		
Atropine	0	60	0	100	–	O		
Barium Sulfate	0	93	0	100	X	O	X	
Barium Sulfate	93	120	0	100	–	–		
Beef Tallow					O	O		
Beer	0	37	0	100	O	O		
Beer	37	150	0	100	O	–		
Beeswax Bleach Solution	0	104	0	100	–	O		
Benzene	0	116	0	100	O	O		
Benzene Hexachloride	0	200	0	100	X	O	X	
Benzoic Acid	0	82	0	10	X	O	X	
Benzoic Acid	0	104	10	100	–	–		
Benzoic Acid	104	120	10	100	–	–		
Benzophenone					–	O		
Benzoquinine					O	O		
Benzoyl Chloride					–	O		
Benzoyl Peroxide					–	O		
Benzyl Chloride	0	50	0	100	X	O	X	
Benzyl Chloride	0	120	0	100	X	X	X	
Black Acid	0	210	0	100	X	X	X	
Black Liquor	20	90	0	100	O	O		
Bleach					X	O	X	

SS = Stainless steel
 NSC = Ni-Span-C Alloy 902
 C22 = Nickel alloy C22

See page 38 for material compatibility codes.

Material compatibility for tube density meters *continued*

Fluid name	Temp (°C)		Conc. (%wt)		Compatibility			Notes
	Low	High	Low	High	SS	C22	NSC	
Boric Acid	0	30	0	10	O	O		
Boric Acid	0	120	0	10	X	O	X	
Boric Acid	120	150	0	10	–	O		
Boric Acid	150	250	0	10	–	O		
Boron Sulfate					–	O		
Boron Trifluoride					–	O		
Boron Trifluoride Etherate	0	57	0	100	–	O		
Brine					X	O	X	
Bromethylbenzene					X	–	X	
Bromine	0	20	0	100	X	X	X	Wet gas
Bromine	0	66	0	100	X	O	X	Dry gas
Bromine	20	150	0	100	X	–	X	Wet gas
Butadiene	0	60	0	100	O	O		
Butadiene	60	120	0	100	–	O		
Butane					O	O		
Butanol					O	–		
Butyl Acetate	0	120	0	100	O	O		
Butyl Aldehyde					O	–		
Butylamine					O	O		
Butylene Glycol					–	–		
Calcium Carbonate					O	O		
Calcium Chloride	0	93	0	40	X	O	X	
Calcium Chloride	0	93	40	100	X	O	X	
Calcium Chloride	93	120	0	40	X	–	X	
Calcium Chloride	93	120	40	100	X	O	X	
Calcium Chloride	120	200	4	100	X	O	X	
Calcium Hydroxide	0	50	0	50	O	O		
Calcium Hydroxide	0	100	0	50	X	O	X	
Calcium Lignosulphonate					–	O		
Calcium Pyridine Sulfonate	0	66	0	100	–	O		
Calcium Sulfide	0	47	0	100	X	O	X	
Canola Oil					O	O		
Carbolite					O	O		
Carbon Dioxide	0	120	0	100	O	O		Dry
Carbon Dioxide	0	120	0	100	X	C	X	
Carbon Disulfide	0	43	0	100	O	–		
Carbon Disulfide	43	65	0	100	–	–		
Carbon Disulfide	65	93	0	100	–	–		
Carbon Tetrachloride	0	60	0	100	O	O		Dry
Carbon Tetrachloride	60	120	0	100	–	–		Dry

SS = Stainless steel
 NSC = Ni-Span-C Alloy 902
 C22 = Nickel alloy C22

See page 38 for material compatibility codes.

Material compatibility for tube density meters *continued*

Fluid name	Temp (°C)		Conc. (%wt)		Compatibility			Notes
	Low	High	Low	High	SS	C22	NSC	
Carbon Tetrachloride					X	O	X	Wet
Carbon Tetrafluoride					X	–	X	
Carbonic Acid					X	O	X	Wet
Carbonochloric Acid					X	O	X	
Carboxylic Acid Salts					–	O		
Ceda Clean					–	O		
Cement					O	O		
Cerium Acetate					–	O		
Cetylpyridinium					O	O		
Cetylpyridinium Chloride					X	O	X	
Chloric Acid	0	31	0	20	X	O	X	
Chloric Acid	0	70	0	50	X	X	X	
Chlorinated Hydrocarbons					X	O	X	
Chlorinated Phenol					X	O	X	
Chlorinated Pyridine					X	O	X	
Chlorinated, Fluorinated Pyradines					X	O	X	
Chlorine	0	104	0	100	X	O	X	Dry gas or liquid
Chlorine	0	120	0	100	X	O	X	Gas
Chlorine Dioxide					X	O	X	
Chloro Nitro Ethane					X	O	X	
Chloro Trifluoroethylene	0	49	0	100	–	O		
Chloroacetic Acid					X	O	X	
Chloroacetyl Chloride					X	O	X	
Chlorobenzene	0	38	0	60	X	O	X	
Chlorodifluoroethane					X	O	X	
Chlorodifluoromethane					X	–	X	
Chloroform	0	21	0	100	O	O		
Chloroform	21	95	0	100	X	X	X	
Chloroform	95	104	0	100	X	X	X	
Chlorophenol	0	60	0	5	X	O	X	
Chloropicrin	0	95	0	0	X	O	X	
Chlorosilane					–	O		
Chlorosulfonic Acid	0	85	0	100	X	O	X	
Chlorotetrahydrophthalic Anhydride					X	O	X	
Chocolate					O	–		
Choline Chloride					X	O	X	
Chromic Oxide					–	O		Based on 50% chromic acid
Chromiumtrioxide			0	100	–	–		Chromic acid
Chromium Sulfate					O	O		

SS = Stainless steel
 NSC = Ni-Span-C Alloy 902
 C22 = Nickel alloy C22

See page 38 for material compatibility codes.

Material compatibility for tube density meters *continued*

Fluid name	Temp (°C)		Conc. (%wt)		Compatibility			Notes
	Low	High	Low	High	SS	C22	NSC	
Citric Acid	0	100	0	50	O	O		
Citric Acid	100	120	0	50	X	O	X	
Coal Tar Fuel					O	O		
Coal Tar Pitch					O	O		
Cobalt Hydroxide	0	200	0	100	X	–	X	
Cobalt Octoate					O	O		
Cocoa Butter					O	–		
Coconut Oil					O	–		
Coke Gas Oil					O	O		
Compressed Natural Gas					O	O		
Concrete					O	O		
Copper Bromide					X	–	X	
Copper Sulfate	0	104	0	100	X	O	X	
Corn Oil					O	O		
Corn Oil and Garlic					O	O		
Corn Steep Liquor					O	O		
Corn Syrup					O	O		
Creosote Oil					X	O	X	
Cresol					O	O		
Cresylic Acid	0	100	0	100	–	O		
Crude Geranyl Ester					O	O		
Cupric Bromide	0	30	0	100	X	X	X	
Cupric Chloride	0	104	0	5	X	X	X	
Cupric Chloride	0	21	5	50	X	O	X	
Cupric Chloride	21	120	5	50	X	X	X	
Cyanogen Chloride	0	46	0	20	–	O		
Cyclohexane	0	93	0	100	O	X		
Cyclohexane	93	120	0	100	O	X		
Cyclopropylamine					O	O		
Decane Sulfonyl Fluoride					X	–	X	
Diacryl Phthalate	0	15	0	100	O	–		
Dibromobenzene	0	200	0	100	X	–	X	
Dichloroacetyl Chloride					X	–	X	
Dichlorobenzene					X	O	X	
Dichlorobutene					X	O	X	
Dichlorodifluoromethane	0	21	0	100	X	O	X	
Dichlorodifluoromethane	21	71	0	100	X	–	X	
Dichlorofluoroethane					–	O		
Dichlorophenol	0	120	0	100	X	O	X	
Dichlorotrifluoroethane					X	–	X	

SS = Stainless steel
 NSC = Ni-Span-C Alloy 902
 C22 = Nickel alloy C22

See page 38 for material compatibility codes.

Material compatibility for tube density meters *continued*

Fluid name	Temp (°C)		Conc. (%wt)		Compatibility			Notes
	Low	High	Low	High	SS	C22	NSC	
Diesel Fuel	0	38	0	100	O	O		
Diesel Fuel	38	120	0	100	O	O		
Diethanolamine	0	100	0	100	O	O		
Diethyl Aluminum Chloride					X	–	X	
Diethyl Disulfide	0	90	0	100	–	O		
Diethyl Sulfate					–	O		
Diethyl Sulfide					–	O		
Diethylamine	0	120	0	100	O	X		
Diethylene Glycol	0	52	0	100	O	X		
Diethylene Glycol	52	76	0	100	O	–		
Difluorobenzonitrile					–	–		
Difluoromonoethane					–	O		
Dihydrogen Sulfide					–	O		
Diisononylphthalate					O	O		
Diisopropyl Peroxydicarbonate					O	O		
Dimethyl Aminoethyl Methacrylate					O	–		
Dimethyl Chloride					X	O	X	
Dimethyl Dichloride					X	O	X	
Dimethyl Formaldehyde					O	–		
Dimethyl Hydrazine					O	O		
Dimethyl Malonate	0	100	0	100	–	O		
Dimethyl Succinate			0	100	O	O		
Dimethyl Sulfate					O	O		
Dimethyl Sulfide					O	O		
Dimethyl Terephthalate					O	–		
Dimethylacetamide	0	200	0	100	X	–	X	
Dimethylamine	25	180	0	100	O	–		
Dimethylpolysiloxanes					O	O		
Dinitrotoluene					O	O		
Diphenyl Methane Diisocyanate					O	O		
Diphenylamine	0	100	0	100	–	O		
Dipropyl Peroxydicarbonate					O	O		
Disobutylene					O	O		
Disodium Iminodiacetate					X	–	X	
Divinylbenzene					O	O		
Dodecyl Mercaptan					O	O		
Dodecylbenzene Sulfonic Acid					–	O		

SS = Stainless steel
 NSC = Ni-Span-C Alloy 902
 C22 = Nickel alloy C22

See page 38 for material compatibility codes.

Material compatibility for tube density meters *continued*

Fluid name	Temp (°C)		Conc. (%wt)		Compatibility			Notes
	Low	High	Low	High	SS	C22	NSC	
Drilling Mud					O	O		
Egg Slurry					O	O		
Epichlorohydrine	0	60	0	100	O	O		Dry
Epoxy Resin					O	O		
Ercimide					–	O		
Ester Vinyl Ether					X	O	X	
Ether	20	100	0	100	O	X		
Ethyl Acetate	20	65	0	100	O	O		
Ethyl Alcohol					O	–		
Ethyl Benzene	0	60	0	100	O	O		
Ethyl Benzene	60	100	0	100	O	O		
Ethyl Monochloroacetate					X	O	X	
Ethylbenzene Sulfonyl Fluoride					–	O		
Ethylene					O	O		Gas
Ethylene Chlorohydrin	0	100	0	100	X	O	X	
Ethylene Diamine	0	37	0	100	O	X		
Ethylene Diamine	37	43	0	100	–	–		
Ethylene Dichloride	0	93	0	100	X	O	X	
Ethylene Glycol	0	120	0	100	O	O		
Ethylene Glycol	120	200	0	100	–	O		
Ethylene Glycol/Bromoform				97	X	–	X	
Ethylene Oxide	0	31	0	100	O	O		
Ethylene Oxide	31	120	0	100	O	–		
Ethylproplacrolein					O	O		
Evaposhine					X	O	X	
Fat/Garlic					O	O		
Fatty Acid	0	120	0	100	O	O		
Fatty Acid	120	200	0	100	O	O		
Ferric Chloride	0	25	0	10	X	O	X	
Ferric Chloride		80		100	X	X	X	
Ferric Nitrate	0	20	0	100	X	O	X	
Ferric Nitrate	20	120	0	100	X	–	X	
Ferric Nitrite					O	O		
Ferric Sulfate	0	60	0	10	O	O		
Ferric Sulfate	0	60	10	30	–	O		
Ferric Sulfate	0	98	30	100	–	–		
Ferric Sulfate	60	98	0	10	–	–		
Ferric Sulfate	60	98	10	30	–	–		
Ferrous Chloride	0	25	0	10	–	O		
Ferrous Chloride	0	120	0	100	X	X	X	

SS = Stainless steel
 NSC = Ni-Span-C Alloy 902
 C22 = Nickel alloy C22

See page 38 for material compatibility codes.

Material compatibility for tube density meters *continued*

Fluid name	Temp (°C)		Conc. (%wt)		Compatibility			Notes
	Low	High	Low	High	SS	C22	NSC	
Ferrous Sulfate	0	120	0	100	X	O	X	
Fluorine					X	O	X	Dry
Fluoroalcohol					X	–	X	
Fluorobenzene					X	–	X	
Fluorosulfonic Acid					X	–	X	
Fluorotrichloromethane					X	–	X	
Food Product					–	O		
Formaldehyde					O	–		
Formic Acid	0	30	0	10	O	O		Aerated
Formic Acid	0	100	0	5	X	O	X	Aerated
Formic Acid	0	104	10	85	X	O	X	
Formic Acid	100	120	0	5	X	–	X	Aerated
Formic Acid	120	153	0	5	X	–	X	Aerated
Fruit Juice					O	O		
Gasoline	0	43	0	100	O	O		
Gasoline	43	120	0	100	–	O		
Gelatin					O	–		
Glycerine	0	104	0	100	O	O		
Glycolite					O	O		
Glyoxalic Acid	0	50			X	O	X	
Green Liquor					–	O		
Halogenated Alkyl Ether					X	–	X	
Halogenated Alkyl Ether					X	O	X	
Halogenated Styrene					–	O		
Helium					O	O		
Heptane	0	60	0	100	O	O		
Heptane	60	98	0	100	–	O		
Hexachlorocyclopentadiene					X	X	X	Chlorinated cyclic olefin (C5Cl6)
Hexafluoropropene					–	O		
Hexahydrophthalic Anhydride					O	O		
Hexamethylenediisocyanate					–	O		
Hexane					O	O		
Hydrazine					O	O		
Hydrobromic Acid					X	X	X	
Hydrochloric Acid ⁽¹⁾	0	30	0	5	X	O	X	
Hydrochloric Acid ⁽¹⁾	0	120	0	15	X	C	X	
Hydrochloric Acid ⁽¹⁾	0	120	15	38	X	X	X	
Hydrochloric Acid ⁽¹⁾	120	200	0	38	X	X	X	

SS = Stainless steel
 NSC = Ni-Span-C Alloy 902
 C22 = Nickel alloy C22

See page 38 for material compatibility codes.

(1) Refer to page 32 for additional information about HCl.

Material compatibility for tube density meters *continued*

Fluid name	Temp (°C)		Conc. (%wt)		Compatibility			Notes
	Low	High	Low	High	SS	C22	NSC	
Hydrochloric Acid Slurry ⁽¹⁾			0	15	X	O	X	
Hydrofluoric Acid	0	120	0	100	X	X	X	Aqueous
Hydrofluosilicic Acid			10	50	X	X	X	
Hydrogen	0	120	0	100	O	O		
Hydrogen	120	200	0	100	O	O		
Hydrogen Bromide					X	X	X	
Hydrogen Chloride					X	–	X	Wet
Hydrogen Chloride					O	O		Dry
Hydrogen Cyanide	0	31	0	100	O	O		
Hydrogen Cyanide	31	53	0	100	–	O		
Hydrogen Cyanide	53	120	0	100	–	–		
Hydrogen Fluoride	0	43	0	100	O	O		Dry
Hydrogen Peroxide	0	90	0	5	O	O		
Hydrogen Peroxide	0	90	0	50	O	O		Acid free
Hydrogen Peroxide	0	48	50	90	O	O		
Hydrogen Sulfide	0	31	0	100	O	O	O	Dry gas
Hydrogen Sulfide	0	38	0	100	X	O	X	Wet gas
Hydrogen Sulfide	31	82	0	100	O	O	X	Dry gas
Hydrogen Sulfide	38	120	0	100	X	–	X	Wet gas
Hydrogen Sulfide	82	120	0	100	X	–	X	Dry gas
Hydrogen Sulfide					X	X	X	Wet gas
Hydroquinone					O	O		
Hydroxymethyl Ester					O	O		
Hydroxyphenylethanone					O	O		
Hydroxypropylmethylcellulose					X	–	X	Opadry
Hypochlorite					X	O	X	
Hypochlorous Acid					X	O	X	
Ice Cream					O	O		
Igepon Surfactant					O	O		
Ink					O	–		
Insulin Extract					–	O		
Iron Sulfate					X	O	X	
Isobutanol					O	–		
Isobutyl Acetate					O	–		
Isooctyl Alcohol					O	O		
Isopar E					O	O		
Isopentane					O	O		
Isopropyl Acetate					O	O		
Isopropyl Alcohol					O	O		
Isopropylamine					O	O		

SS = Stainless steel
 NSC = Ni-Span-C Alloy 902
 C22 = Nickel alloy C22

See page 38 for material compatibility codes.

Material compatibility for tube density meters *continued*

Fluid name	Temp (°C)		Conc. (%wt)		Compatibility			Notes
	Low	High	Low	High	SS	C22	NSC	
Jet Fuel	0	30	0	100	O	O		
Kathon Lx 1.5% Biocide					X	O	X	
Kerosene					O	O		
Ketchup					O	O		
Lactic Acid	0	49	0	10	O	O		
Lactic Acid	0	49	10	25	O	O		
Lactic Acid	49	104	0	10	X	O	X	
Lactic Acid	49	60	10	25	X	O	X	
Lactic Acid	104	120	0	10	–	–		
Lactic Acid			25	100	X	X	X	
Lactose	0	100	0	100	O	–		
Laoquer Thinner/Lupranate					O	O		
Lard Oil					O	O		
Lasso Herbicide					X	–	X	
Latex	0	60	0	100	O	–		
Latex Emulsion					O	O		
Lauryl Bromide					X	O	X	
Lead Acetate	0	104	0	100	O	O		
Lime Slurry	0	55	0	100	X	O	X	
Limestone	0	49	0	8	O	O		
Liquefied Petroleum Gas					O	O		
Lithium Bromide					X	O	X	
Lithium Chloride	0	100	0	60	X	O	X	
Magnesium Chloride	0	120	0	100	X	O	X	
Magnesium Chloride	120	153	50	100	X	O	X	
Magnesium Hydroxide	0	100	0	100	O	O		
Magnesium Hydroxide	100	120	0	100	–	–		
Magnesium Nitrate	0	93	0	100	O	O		
Magnesium Oxide					O	O		
Magnesium Silicate					O	O		
Magnesium Sulfate	0	93	0	50	–	O		
Magnetic Slurries					–	O		
Maleic Acid	0	80	0	100	O	O		
Maleic Acid	80	120	0	100	X	–	X	
Maleic Anhydride					O	O		
Malumar					O	O		
Manganese Cobalt Acetate					O	O		
Manganese Sulfate	0	63	0	100	–	O		
Mayonnaise					O	O		
Mercaptan					O	O		

SS = Stainless steel
 NSC = Ni-Span-C Alloy 902
 C22 = Nickel alloy C22

See page 38 for material compatibility codes.

Material compatibility for tube density meters *continued*

Fluid name	Temp (°C)		Conc. (%wt)		Compatibility			Notes
	Low	High	Low	High	SS	C22	NSC	
Mercapto Ethanol					O	O		
Methacrylic Acid					O	O		
Methane					O	O		
Methanol	0	100	0	100	O	O		
Methyl Acetate	0	60	0	60	O	O		
Methyl Acrylate					O	O		
Methyl Acrylic Acid					–	O		
Methyl Alcohol	0	100	0	100	O	O		
Methyl Benzimidazole Zinc Salt					–	O		
Methyl Bromide	0	20	0	100	O	–		
Methyl Bromide	20	120	0	100	–	–		
Methyl Chloride	0	104	0	100	X	O	X	
Methyl Chloride	0	120	0	100	O	O		Dry
Methyl Ethyl Ketone	0	93	0	100	O	O		
Methyl Iodide					X	–	X	
Methyl Methacrylate					O	O		
Methylamine					O	–		
Methyldichlorosilane					X	O	X	
Methylene Chloride	0	30			O	O		Dry
Methylene Chloride	0	30	0	100	X	X	X	
Methylene Chloride	0	120	0	100	X	X	X	
Methylpyrrolidone					O	O		
Mineral Oil					O	O		
Mineral Spirits					O	O		
Molasses					O	O		
Monochlorobenzene					X	O	X	
Monochlorodifluoromethane					O	O		
Monoethanoamine Hydrochloride	0	65	0	100	–	O		
Monoethanol Amine					X	O	X	
Monoethanolamine	0	100	0	90	O	O		
Morpholine					O	O		
Musk Concentrate					O	O		
Mustard Gas					X	–	X	
Nadir Methyl Anhydride					O	O		
Nalco 625					–	O		
Naphtha					O	O		
Naphthalene	0	120	0	100	O	O		

SS = Stainless steel
 NSC = Ni-Span-C Alloy 902
 C22 = Nickel alloy C22

See page 38 for material compatibility codes.

(1) Refer to page 34 for additional information about HNO₃.

Material compatibility for tube density meters *continued*

Fluid name	Temp (°C)		Conc. (%wt)		Compatibility			Notes
	Low	High	Low	High	SS	C22	NSC	
Naphthalene Sulfonic Acid	0	200	0	100	–	O		
Neopentyl Glycol					–	O		
Nickel Chloride	0	90	0	100	X	O	X	
Nickel Slurry					O	O		
Nitric Acid ⁽¹⁾	–18	10	0	75	O	O		
Nitric Acid ⁽¹⁾	–18	10	75	100	O	O		
Nitric Acid ⁽¹⁾	10	24	0	70	O	X		
Nitric Acid ⁽¹⁾	10	24	70	100	O	X		
Nitric Acid ⁽¹⁾	24	38	0	20	O	O		
Nitric Acid ⁽¹⁾	24	38	20	50	O	X		
Nitric Acid ⁽¹⁾	24	38	50	90	X	X	X	
Nitric Acid ⁽¹⁾	24	38	90	100	X	X	X	
Nitric Acid ⁽¹⁾	38	52	0	10	O	O		
Nitric Acid ⁽¹⁾	38	52	10	40	O	X		
Nitric Acid ⁽¹⁾	38	52	40	70	X	X		
Nitric Acid ⁽¹⁾	38	52	70	80	X	X		
Nitric Acid ⁽¹⁾	38	52	80	100	X	X	X	
Nitric Acid ⁽¹⁾	52	66	0	30	O	X		
Nitric Acid ⁽¹⁾	52	66	30	70	X	X	X	
Nitric Acid ⁽¹⁾	52	66	70	100	X	X	X	
Nitric Acid ⁽¹⁾	66	80	0	20	O	X		
Nitric Acid ⁽¹⁾	66	80	20	45	X	X	X	
Nitric Acid ⁽¹⁾	66	80	45	55	X	X	X	
Nitric Acid ⁽¹⁾	66	80	55	100	X	X	X	
Nitric Acid ⁽¹⁾	80	93	0	45	X	X	X	
Nitric Acid ⁽¹⁾	80	93	45	100	X	X	X	
Nitric Acid ⁽¹⁾	93	163	0	100	X	X	X	
Nitroaniline					X	O	X	
Nitrobenzene					O	O		
Nitrochlorobenzene					X	O	X	
Nitrogen					O	O		
Nonanoic Acid Sludge					X	O	X	
Nonyl Phenol					O	O		
Octanol					O	O		
Oil Emulsion					O	O	O	
Oil, Crude					O	O	O	
Oil, Fuel					O	O	O	
Oil, Gas					O	O	O	
Oil, Hydraulic Cylinder					O	O	O	

SS = Stainless steel
 NSC = Ni-Span-C Alloy 902
 C22 = Nickel alloy C22

See page 38 for material compatibility codes.

(1) Refer to page 34 for additional information about HNO₃.

Material compatibility for tube density meters *continued*

Fluid name	Temp (°C)		Conc. (%wt)		Compatibility			Notes
	Low	High	Low	High	SS	C22	NSC	
Oil, Lube					O	O	O	
Oil, Soybean					O	O		
Oil, Spindle					O	O		
Oil, Transformer					O	O		
Oil, Turpentine					O	O		
Oil, Vegetable	0	43	0	100	O	O		
Oil, Vegetable	43	104	0	100	O	–		
Oil, Waste					X	O	X	
Oleum	20	50	0	100	–	O		
Orange Juice					O	O		
Oxalic Acid	0	104	0	10	X	O	X	
Oxygen					O	O		
Ozonated Water					O	–		
Ozone					O	O		
Paint					O	O		
Palmitic Acid					O	–		
Paper Pulp	0	74	0	15	X	O	X	Chlorine bleached
Paraffine					O	O		
Paranitrochlorinebenzene					X	–	X	
Pentamethyl Indan					O	O		
Pentane					O	O		
Perchloroethylene					O	O		
Perfluorochemical Inert Liquid					X	–	X	
Peroxide Acid					–	O		
Phenol			0	95	–	O		
Phenol					O	O		
Phenol Formaldehyde	0	130	0	100	–	O		
Phenolsulfonic Acid					O	O		
Phenothiazine					O	O		
Phosgene	20	65	0	100	X	O	X	
Phosphoric Acid	0	25	0	70	O	O		Food Grade
Phosphoric Acid			0	5	O	O		
Phosphoric Acid			5	40	X	O	X	
Phosphoric Acid			40	98	X	O	X	
Phosphoric Acid			98	100	X	X	X	
Phosphoric Acid/Sodium Hydroxide					X	O	X	
Phosphorous					X	O	X	
Phosphorous Acid					X	O	X	
Phosphorous Oxychloride					X	–	X	

SS = Stainless steel
 NSC = Ni-Span-C Alloy 902
 C22 = Nickel alloy C22

See page 38 for material compatibility codes.

Material compatibility for tube density meters *continued*

Fluid name	Temp (°C)		Conc. (%wt)		Compatibility			Notes
	Low	High	Low	High	SS	C22	NSC	
Phosphorous Trichloride					X	X	X	
Phthalic Acid					O	O		
Phthalic Anhydride	-18	99	98	100	O	O		
Phthalic Anhydride	99	149	98	100	O	O		
Phthalic Anhydride	149	204	98	100	O	O		
Phthalic Anhydride/Thermon					-	O		
Picric Acid					O	O		
Pitch	100	200	0	100	O	-		
Pivalic Acid					O	O		
Platinum Chloride					X	-	X	
Polyacrylamide					O	O		
Polyamine	0	182	0	100	-	O		
Polybutyl Chloride					X	O	X	
Polydimethylaminetetra-chlorohydrate					-	O		
Polyester					O	O		
Polyethylene					O	O		
Polyethylene Glycol					O	O		
Polyethylene Wax					O	O		
Polyisobutylene					O	O		
Polyol					O	O		
Polyphosphorous					X	O	X	
Polyvinyl Alcohol					O	O		
Potassium Acetate					-	-		
Potassium Bisulfite	0	63	0	100	-	O		
Potassium Bromide	0	31	0	30	X	O	X	
Potassium Bromide	0	104	30	50	X	X	X	
Potassium Bromide	0	104	50	100	-	-		
Potassium Carbonate					O	O		
Potassium Carbonate					X	O	X	
Potassium Chloride	0	110	0	99	X	O	X	
Potassium Chloride	0	160	0	99	X	X	X	
Potassium Chromate	0	24	0	10	X	O	X	
Potassium Hydroxide	0	93	0	40	O	O		
Potassium Hydroxide	0	100	40	50	X	O	X	
Potassium Iodide					O	-		
Potassium Nitrate	0	100			X	O	X	
Potassium Permanganate	0	100	0	50	X	O	X	
Potassium Persulfate	0	24	0	4	X	O	X	
Potassium Persulfate					O	-		
Primary Stearyl Amine					O	O		

SS = Stainless steel
 NSC = Ni-Span-C Alloy 902
 C22 = Nickel alloy C22

See page 38 for material compatibility codes.

Material compatibility for tube density meters *continued*

Fluid name	Temp (°C)		Conc. (%wt)		Compatibility			Notes
	Low	High	Low	High	SS	C22	NSC	
Propane					O	O		
Propionic Acid	0	140	0	97	–	O		
Propyl Alcohol	0	104	0	100	O	O		
Propylene					O	O		
Propylene Glycol					O	O		
Propylene Oxide					O	O		
Pyridine					X	X	X	
Rhodium					O	O		
Rosin	0	200	0	100	–	O		
Roundup Herbicide					X	O	X	
Rubber Cement					O	O		
Rubber Hydrocarbon					O	O		
Safety-kleen 105					O	O		
Salicylic Acid	0	120	0	100	X	O	X	
Scalp Oil					X	O	X	
Sebacic Acid	0	104	0	10	–	O		
Sentol (Liquid Acid Cleaner)					–	O		
Silica Slurry					O	O		
Silicon Dioxide					O	O		
Silicon Tetrafluoride					X	–	X	
Silicone					O	O		
Silicone Oil					O	O		
Silicontetrachloride Slurry					O	O		
Silver Nitrate					O	O		
Soap Fat	0	200	0	100	–	O		
Soap Solution					O	O		
Sodium Alkyl Glyceryl Sulfonate					–	O		
Sodium Aluminate					O	O		
Sodium Bicarbonate			0	20	O	O		
Sodium Bicarbonate			20	100	–	–		
Sodium Bisulfate	0	82	0	20	X	O	X	
Sodium Bisulfite					X	O	X	
Sodium Carbonate	0	100	0	25	O	O		
Sodium Carbonate	0	100	25	100	O	O		
Sodium Carbonate/Sulfuric Acid					O	O		
Sodium Chlorate	0	104	0	70	X	O	X	
Sodium Chlorate	60	150	70	100	X	O	X	

SS = Stainless steel
 NSC = Ni-Span-C Alloy 902
 C22 = Nickel alloy C22

See page 38 for material compatibility codes.

(1) Refer to page 33 for additional information about NaOH.

Material compatibility for tube density meters *continued*

Fluid name	Temp (°C)		Conc. (%wt)		Compatibility			Notes
	Low	High	Low	High	SS	C22	NSC	
Sodium Chloride	0	60	0	100	X	O	X	
Sodium Cyanide	0	38	0	10	O	O		
Sodium Cyanide	0	120	0	100	X	X	X	
Sodium Formaldehyde					O	O		
Sodium Formaldehyde Bisulfate					O	O		
Sodium Formaldehyde sulfoxylate					–	O		
Sodium Gluconate					O	O		
Sodium Hydrosulfate					O	O		
Sodium Hydrosulfide					X	–	X	
Sodium Hydrosulfide					–	O		
Sodium Hydrosulfite					O	O		
Sodium Hydroxide ⁽¹⁾	0	53	0	15	O	O		Observe chloride limits of Fig 2
Sodium Hydroxide ⁽¹⁾	0	53	15	20	O	O		Observe chloride limits of Fig 2
Sodium Hydroxide ⁽¹⁾	0	53	20	50	X	O	X	Observe chloride limits of Fig 2
Sodium Hydroxide ⁽¹⁾	53	86	0	50	X	O	X	Observe chloride limits of Fig 2
Sodium Hydroxide ⁽¹⁾	86	120	0	100	X	X	X	Observe chloride limits of Fig 2
Sodium Hypochlorite	0	30	0	1	O	O		
Sodium Hypochlorite	30	60	0	16	X	O	X	
Sodium Hypochlorite	60	120	0	16	X	X	X	
Sodium Hypophosphite					O	O		
Sodium Metabisulfite					–	O		
Sodium Metal					X	O	X	
Sodium Nitrate	0	112	0	60	O	O		
Sodium Nitrate	0	120	60	100	–	–		
Sodium Nitrite					X	O	X	
Sodium Omandine					X	–	X	
Sodium Perchlorate	0	65	0	100	–	O		
Sodium Persulfate					–	O		
Sodium Phenolate	0	120	0	100	–	O		
Sodium Phosphate	0	100			X	O	X	
Sodium Polyphosphate					–	O		
Sodium Silicate					O	O		
Sodium Sulfate	0	100	0	20	O	O		
Sodium Sulfide	0	120	0	50	X	O	X	
Sodium Sulfite	0	120	0	10	X	O	X	
Sodium Xylene Sulphonate					O	O		
Soy Oil					O	O		

SS = Stainless steel
 NSC = Ni-Span-C Alloy 902
 C22 = Nickel alloy C22

See page 38 for material compatibility codes.

(1) Refer to page 34 for additional information about H₂SO₄.

Material compatibility for tube density meters *continued*

Fluid name	Temp (°C)		Conc. (%wt)		Compatibility			Notes
	Low	High	Low	High	SS	C22	NSC	
Soy Protein			0	18	–	O		
Soy Sauce					X	O	X	
Spent Acid					X	X	X	
Stannic Chloride					X	O	X	
Stannous Chloride	0	75	0	10	O	O		
Stannous Chloride	0	120	10	100	X	O	X	
Starch Syrup					O	O		
Stearic Acid					O	O		
Styrene					O	O		
Sucrose	0	93	0	62	O	O		
Sulfamic Acid	0	30			O	O		
Sulfite Liquor					X	O	X	
Sulfolane					O	O		
Sulfonic Acid					C	O		
Sulfonylchloride					X	O	X	
Sulfur	0	120	0	100	O	O		Molten
Sulfur Dichloride					X	O	X	
Sulfur Dioxide					O	O		Dry
Sulfur Dioxide					X	O	X	Wet
Sulfur Monochloride/Isobutylene					X	–	X	
Sulfur Trioxide	0	25	0	100	–	O		
Sulfuric Acid ⁽¹⁾	–18	24	0	20	O	O		Maintain Velocity < 10 ft/sec
Sulfuric Acid ⁽¹⁾	–18	24	20	65	X	O	X	Maintain Velocity < 10 ft/sec
Sulfuric Acid ⁽¹⁾	–18	24	65	75	X	X	X	Maintain Velocity < 10 ft/sec
Sulfuric Acid ⁽¹⁾	–18	24	75	98	C	O		Maintain Velocity < 5 ft/sec
Sulfuric Acid ⁽¹⁾	24	38	0	10	O	O		Maintain Velocity < 10 ft/sec
Sulfuric Acid ⁽¹⁾	24	38	10	40	X	O	X	Maintain Velocity < 10 ft/sec
Sulfuric Acid ⁽¹⁾	24	38	40	75	X	X	X	Maintain Velocity < 10 ft/sec
Sulfuric Acid ⁽¹⁾	24	38	75	85	–	–		Maintain Velocity < 4 ft/sec
Sulfuric Acid ⁽¹⁾	24	38	85	93	–	O		Maintain Velocity < 10 ft/sec
Sulfuric Acid ⁽¹⁾	24	38	93	98	O	O		Maintain Velocity < 10 ft/sec
Sulfuric Acid ⁽¹⁾	38	52	0	5	O	O		Maintain Velocity < 10 ft/sec
Sulfuric Acid ⁽¹⁾	38	52	5	25	X	O	X	Maintain Velocity < 10 ft/sec
Sulfuric Acid ⁽¹⁾	38	52	25	75	X	X	X	Maintain Velocity < 10 ft/sec
Sulfuric Acid ⁽¹⁾	38	52	75	90	–	–		Maintain Velocity < 3 ft/sec
Sulfuric Acid ⁽¹⁾	38	52	90	98	–	O		Maintain Velocity < 10 ft/sec
Sulfuric Acid ⁽¹⁾	52	54	0	5	X	O	X	Maintain Velocity < 10 ft/sec
Sulfuric Acid ⁽¹⁾	52	54	5	75	X	X	X	Maintain Velocity < 10 ft/sec

SS = Stainless steel

NSC = Ni-Span-C Alloy 902

C22 = Nickel alloy C22

See page 38 for material compatibility codes.

(1) Refer to page 34 for additional information about H₂SO₄.

Material compatibility for tube density meters *continued*

Fluid name	Temp (°C)		Conc. (%wt)		Compatibility			Notes
	Low	High	Low	High	SS	C22	NSC	
Sulfuric Acid ⁽¹⁾	52	54	75	98	–	–		Maintain Velocity < 2 ft/sec
Sulfuric Acid ⁽¹⁾	54	66	0	5	X	O	X	Maintain Velocity < 10 ft/sec
Sulfuric Acid ⁽¹⁾	54	66	5	98	X	X	X	Maintain Velocity < 10 ft/sec
Sulfuric Acid ⁽¹⁾	66	93	0	50	X	X	X	Maintain Velocity < 10 ft/sec
Sulfuric Acid ⁽¹⁾	66	93	50	98	X	X	X	Maintain Velocity < 10 ft/sec
Sulfuric Acid ⁽¹⁾	93	204	0	98	X	X	X	Maintain Velocity < 10 ft/sec
Sulfuric Fluoride					X	–	X	
Sulfuryl Chloride					X	O	X	
Sulphenilic Acid					O	O		
Sulphurous Acid					X	O	X	
Tall Oil Fatty Acid					–	O		
Tall Oil Rosin					–	O		
Tall Oil Soap					X	O	X	
Tar	150	200			O	O		
Tar Acid	0	200	0	100	X	O	X	
Tea					O	O		
Terephthalic Acid	100	160	0	100	O	O		
Tetrachloroethane	0	70	0	100	X	O	X	
Tetrachloroethylene Sulfide					X	O	X	
Tetrachlorosilane					X	O	X	
Tetrafluoroethane					O	O		Dry
Tetrahydrofluorine					–	–		
Tetrahydrofuran					O	O		
Tetrasodium EDTA					O	O		
Thinner					O	O		
Thiodichloric Acid					X	O	X	
Tin Liquor					X	O	X	
Titanium Chloride					X	O	X	
Titanium Dioxide					O	O		
Titanium Iron Sulfate Solution					–	–		
Titanium Tetrachloride					X	O	X	
Toluene					O	O		
Toluene Diisocyanate					O	O		
Toluenesulfonic Acid	0	125	0	94	C	O		
Tomato Paste					O	O		
Triacetin					O	O		
Tribromomethane					X	–	X	
Trichloroacetic Acid	0	120	0	50	X	O	X	
Trichloroacetyl Chloride					X	O	X	
Trichlorobenzene					X	O	X	

SS = Stainless steel
 NSC = Ni-Span-C Alloy 902
 C22 = Nickel alloy C22

See page 38 for material compatibility codes.

Material compatibility for tube density meters *continued*

Fluid name	Temp (°C)		Conc. (%wt)		Compatibility			Notes
	Low	High	Low	High	SS	C22	NSC	
Trichlorobromomethane					X	–	X	
Trichloroethane					X	X	X	
Trichloroethylene					O	O		Dry
Trichloromethylpyridine					X	O	X	
Trichloromonofluoroethane					O	O		
Trichlorosilane					O	O		
Trichlorotrifluoroethane					O	O		
Triethanolamine	0	95	0	100	O	O		
Triethyl Aluminum					O	O		
Triethylamine					O	O		
Triethylene Glycol					O	O		
Trifluoroacetic Acid					X	O	X	
Trimethyl Sulfonium Bromide					X	–	X	
Trimethylchlorocyanate					X	O	X	
Triphenyl Phosphite					O	O		
Trisodiumphosphate	0	200	0	90	X	O	X	
Tritylchloride					X	O	X	
Turpentine					O	O		
Urea	0	90	0	100	O	O		
Vanadium Benzene					O	O		
Vanadium Chloride					X	O	X	
Vanadium Oxychloride					X	O	X	
Vanadium Oxytrichloride					X	O	X	
Vanadium Tetrachloride					X	O	X	
Vanadium Triacetylacetonate					X	O	X	
Varnish					O	O		
Vazo					X	O	X	
Vegetable Tanning Liquor	0	79	0	100	–	O		
Vinegar					O	O		
Vinyl Acetate					O	O		
Vinyl Acetate Polymer Residues					O	O		
Vinyl Chloride	0	60	0	100	–	O		Latex
Vinyl Chloride	0	65	0	100	O	O		Monomer
Vinyl Fluoride					–	–		
Vinylidene Chloride					X	O	X	
Vitamin E					O	O		
Water	0	200	0	100	O	O		Observe chloride limits of Fig 2
Water/Flour/Starch/Corn Syrup					–	O		
Wax Emulsion					O	O		

SS = Stainless steel
 NSC = Ni-Span-C Alloy 902
 C22 = Nickel alloy C22

See page 38 for material compatibility codes.

Material compatibility for tube density meters *continued*

Fluid name	Temp (°C)		Conc. (%wt)		Compatibility			Notes
	Low	High	Low	High	SS	C22	NSC	
Whey/Milk					O	O		
Whisky					O	O	O	
White Liquor	20	50	0	100	X	O	X	
Wine					O	O		
Xylene	20	120	0	100	O	O		
Yeast					O	O		
Yogurt					O	O		
Zeolite					–	O		
Zinc Carbonate Slurry	0	21	0	100	–	O		
Zinc Carbonate Slurry	21	82	0	100	–	O		
Zinc Chloride	0	107	0	71	X	O	X	
Zinc Dialkyl Dithiophosphate					X	O	X	
Zinc Hydrosulfite	0	120	0	10	X	O	X	
Zinc Sulfate	0	111	0	34	X	O	X	
Zirconium Chloride	0	85	0	25	X	O	X	
Zirconium Chloride					X	O	X	Gas

SS = Stainless steel

NSC = Ni-Span-C Alloy 902

C22 = Nickel alloy C22

See page 38 for material compatibility codes.

Material compatibility for fork density meters, viscosity meters

Fluid name	Temp (°C)		Conc. (%wt)		Material compatibility								Notes
	Low	High	Low	High	316	304	C22	B3	TI	ML	ZR		
Acetaldehyde	-18	93	0	100	O		O		O				
Acetaldehyde	93	149	0	100					O				
Acetate	-18	52	0	100	O		O		O				
Acetate	52	77	0	100	O		O		O				
Acetate	77	100	0	100	O		O		O				
Acetate	100	204	0	100	O		O		O				
Acetic Acid	-18	10	0	50	O	O	O	O	O	O	O	O	Non-aerated. Consult MMI before using zirconium with acetic acid containing copper ions.
Acetic Acid	-18	10	50	80	O	O	O	O	O	O	O	O	Non-aerated. Consult MMI before using zirconium with acetic acid containing copper ions.
Acetic Acid	-18	10	80	95	O	O	O	O	O	O	O	O	Non-aerated. Consult MMI before using zirconium with acetic acid containing copper ions.
Acetic Acid	-18	10	95	100	O	O	O	O	O	O	O	O	Non-aerated. Consult MMI before using zirconium with acetic acid containing copper ions.
Acetic Acid	10	71	0	50	O	O	O	O	O	O	O	O	Non-aerated. Consult MMI before using zirconium with acetic acid containing copper ions.
Acetic Acid	10	71	50	80	O	O	O	O	O	O	O	O	Non-aerated. Consult MMI before using zirconium with acetic acid containing copper ions.
Acetic Acid	10	71	80	95	C	O	O	O	O	O	O	O	Non-aerated. Consult MMI before using zirconium with acetic acid containing copper ions.
Acetic Acid	10	66	95	100	O	O	O	O	O	O	O	O	Non-aerated. Consult MMI before using zirconium with acetic acid containing copper ions.
Acetic Acid	66	93	95	100	O	C	O	O	O	O	O	O	Non-aerated. Consult MMI before using zirconium with acetic acid containing copper ions.

316 = 316L stainless steel
 304 = 304L stainless steel
 C22 = Nickel alloy C22
 B3 = Nickel alloy B3

TI = Titanium Grade 9
 ML = Alloy 400
 ZR = Zirconium Grade 702

See page 38 for material compatibility codes.

Material compatibility for fork density meters, viscosity meters

Fluid name	Temp (°C)		Conc. (%wt)		Material compatibility							Notes
	Low	High	Low	High	316	304	C22	B3	TI	ML	ZR	
Acetic Acid	71	79	0	45	O	C	O	O	O	O	O	Non-aerated. Consult MMI before using zirconium with acetic acid containing copper ions.
Acetic Acid	71	79	45	50	O	C	O	O	O	O	O	Non-aerated. Consult MMI before using zirconium with acetic acid containing copper ions.
Acetic Acid	71	79	50	80	C	C	O	O	O	O	O	Non-aerated. Consult MMI before using zirconium with acetic acid containing copper ions.
Acetic Acid	79	93	0	45	O	C	O	O	O	O	O	Non-aerated. Consult MMI before using zirconium with acetic acid containing copper ions.
Acetic Acid	79	93	45	50	O	C	O	O	O	O	O	Non-aerated. Consult MMI before using zirconium with acetic acid containing copper ions.
Acetic Acid	79	93	50	55	O	C	O	O	O	O	O	Non-aerated. Consult MMI before using zirconium with acetic acid containing copper ions.
Acetic Acid	79	93	55	95	C	C	O	O	O	O	O	Non-aerated. Consult MMI before using zirconium with acetic acid containing copper ions.
Acetic Acid	93	99	0	20	O	O	O	O	O	O	O	Non-aerated. Consult MMI before using zirconium with acetic acid containing copper ions.
Acetic Acid	93	99	20	50	O	C	O	O	O	O	O	Non-aerated. Consult MMI before using zirconium with acetic acid containing copper ions.
Acetic Acid	93	99	50	55	O	C	O	O	O	O	O	Non-aerated. Consult MMI before using zirconium with acetic acid containing copper ions.
Acetic Acid	93	99	55	80	C	C	O	O	O	O	O	Non-aerated. Consult MMI before using zirconium with acetic acid containing copper ions.

316 = 316L stainless steel
 304 = 304L stainless steel
 C22 = Nickel alloy C22
 B3 = Nickel alloy B3

TI = Titanium Grade 9
 ML = Alloy 400
 ZR = Zirconium Grade 702

See page 38 for material compatibility codes.

Material compatibility for fork density meters, viscosity meters

Fluid name	Temp (°C)		Conc. (%wt)		Material compatibility								Notes
	Low	High	Low	High	316	304	C22	B3	TI	ML	ZR		
Acetic Acid	93	99	80	95	C	C	O	O	O	O	O	Non-aerated. Consult MMI before using zirconium with acetic acid containing copper ions.	
Acetic Acid	93	118	95	100	O	X	O	O	O	O	O	Non-aerated. Consult MMI before using zirconium with acetic acid containing copper ions.	
Acetic Acid	99	104	0	20	O	–	O	O	O	X	O	Non-aerated. Consult MMI before using zirconium with acetic acid containing copper ions.	
Acetic Acid	99	104	20	50	O	C	O	O	O	X	O	Non-aerated. Consult MMI before using zirconium with acetic acid containing copper ions.	
Acetic Acid	99	104	50	55	O	C	O	O	O	O	O	Non-aerated. Consult MMI before using zirconium with acetic acid containing copper ions.	
Acetic Acid	99	104	55	80	C	C	O	O	O	O	O	Non-aerated. Consult MMI before using zirconium with acetic acid containing copper ions.	
Acetic Acid	99	104	80	95	C	C	O	O	O	O	O	Non-aerated. Consult MMI before using zirconium with acetic acid containing copper ions.	
Acetic Acid	104	127	0	20	O	X	O	O	O	X	O	Non-aerated. Consult MMI before using zirconium with acetic acid containing copper ions.	
Acetic Acid	104	127	20	50	O	X	O	O	O	X	O	Non-aerated. Consult MMI before using zirconium with acetic acid containing copper ions.	
Acetic Acid	104	127	50	55	O	C	O	O	O	X	O	Non-aerated. Consult MMI before using zirconium with acetic acid containing copper ions.	
Acetic Acid	104	127	50	80	C	C	O	C	O	X	O	Non-aerated. Consult MMI before using zirconium with acetic acid containing copper ions.	

316 = 316L stainless steel
 304 = 304L stainless steel
 C22 = Nickel alloy C22
 B3 = Nickel alloy B3

TI = Titanium Grade 9
 ML = Alloy 400
 ZR = Zirconium Grade 702

See page 38 for material compatibility codes.

Material compatibility for fork density meters, viscosity meters

Fluid name	Temp (°C)		Conc. (%wt)		Material compatibility								Notes
	Low	High	Low	High	316	304	C22	B3	TI	ML	ZR		
Acetic Acid	104	127	80	85	C	C	O	C	O	X	O	Non-aerated. Consult MMI before using zirconium with acetic acid containing copper ions.	
Acetic Acid	104	127	85	95	C	X	O	C	O	X	O	Non-aerated. Consult MMI before using zirconium with acetic acid containing copper ions.	
Acetic Acid	118	204	95	100	O	X	O	C	-	X	-	Non-aerated. Consult MMI before using zirconium with acetic acid containing copper ions.	
Acetic Acid	127	135	0	20	O	X	O	O	O	X	O	Non-aerated. Consult MMI before using zirconium with acetic acid containing copper ions.	
Acetic Acid	127	135	20	50	O	X	O	O	O	X	O	Non-aerated. Consult MMI before using zirconium with acetic acid containing copper ions.	
Acetic Acid	127	135	50	55	O	X	O	O	O	X	O	Non-aerated. Consult MMI before using zirconium with acetic acid containing copper ions.	
Acetic Acid	127	135	50	85	C	X	O	C	O	X	O	Non-aerated. Consult MMI before using zirconium with acetic acid containing copper ions.	
Acetic Acid	127	135	85	95	C	X	O	C	O	X	O	Non-aerated. Consult MMI before using zirconium with acetic acid containing copper ions.	
Acetic Acid	135	149	0	20	O	X	O	O	O	X	O	Non-aerated. Consult MMI before using zirconium with acetic acid containing copper ions.	
Acetic Acid	135	149	20	50	O	X	O	O	O	X	O	Non-aerated. Consult MMI before using zirconium with acetic acid containing copper ions.	
Acetic Acid	135	149	50	55	O	X	O	O	O	X	O	Non-aerated. Consult MMI before using zirconium with acetic acid containing copper ions.	

316 = 316L stainless steel
 304 = 304L stainless steel
 C22 = Nickel alloy C22
 B3 = Nickel alloy B3

TI = Titanium Grade 9
 ML = Alloy 400
 ZR = Zirconium Grade 702

See page 38 for material compatibility codes.

Material compatibility for fork density meters, viscosity meters

Fluid name	Temp (°C)		Conc. (%wt)		Material compatibility								Notes
	Low	High	Low	High	316	304	C22	B3	TI	ML	ZR		
Acetic Acid	135	149	55	95	C	X	–	C	O	X	O	Non-aerated. Consult MMI before using zirconium with acetic acid containing copper ions.	
Acetic Acid	149	204	0	20	O	X	O	–	–	X	–	Non-aerated. Consult MMI before using zirconium with acetic acid containing copper ions.	
Acetic Acid	149	204	20	50	O	X	O	–	–	X	–	Non-aerated. Consult MMI before using zirconium with acetic acid containing copper ions.	
Acetic Acid	149	204	50	55	O	X	O	–	–	X	–	Non-aerated. Consult MMI before using zirconium with acetic acid containing copper ions.	
Acetic Acid	149	204	55	95	C	X	–	–	–	X	–	Non-aerated. Consult MMI before using zirconium with acetic acid containing copper ions.	
Acetic Anhydride	–18	38	0	100	C		O		O				
Acetic Anhydride	38	121	0	100	C		O		O				
Acetic Anhydride	121	143	0	100	C		O		O				
Acetone	–18	60	0	100	O		O		O				
Acetone	60	93	0	100	O		O		O				
Acetone	93	104	0	100	O		O						
Acetone	104	149	0	100	O								
Acetone	149	204	0	100	O								
Acetone Cyanhydrin					O								
Acetone, 50% Water	–18	60	0	100			O		O				
Acetone, 50% Water	60	104	0	100			O		O				
Acetonitrile	0	60	0	100	O								
Acetyl Chloride	–18	21	0	100	O		O						
Acetyl Chloride	21	37	0	100			O						
Acetyl Chloride	37	60	0	100									
Acetylene	0	26	0	100	O		O		O				
Acetylene	26	37	0	100	O		O						
Acetylene	37	116	0	100	O								
Acetylene	116	204	0	100	O								
Acetylene Tetrabromide													
Acetylene Trichloride	0	106	0	90			O						
Acid Pulping	0	80	0	100			O						

316 = 316L stainless steel
 304 = 304L stainless steel
 C22 = Nickel alloy C22
 B3 = Nickel alloy B3

TI = Titanium Grade 9
 ML = Alloy 400
 ZR = Zirconium Grade 702

See page 38 for material compatibility codes.

Material compatibility for fork density meters, viscosity meters

Fluid name	Temp (°C)		Conc. (%wt)		Material compatibility							
	Low	High	Low	High	316	304	C22	B3	TI	ML	ZR	Notes
Acrylic Acid	0	53			O	O						
Acrylic Emulsion					O	O						
Acrylonitrile	0	60	0	100	O	O			O			
Acrylonitrile	60	87	0	100	O	O			O			
Acrylonitrile	87	104	0	100			O					
Acrylonitrile	104	130	0	100								
Adipic Acid	0	10	0	100	O	O			O			
Adipic Acid	10	93	0	100	O	O			O			
Adipic Acid	93	120	0	100					O			
Adipic Acid	120	220	0	100					O			
Air					O	O			O			
Alachlor Technical							O					Chlorodiethylacetanilide
Alcohols	0	100	0	100	O	O						
Alkaline Liquor					O	O						
Alkylbenzene Sulfonic Acid							O					
Alkyldimethyl Ammonium Chloride							O					
Allyl Alcohol	0	93	0	100	O	O						
Allyl Alcohol	93	209	0	100	O							
Allyl Chloride	0	26	0	100	O		O		O			
Allyl Chloride	26	82	0	100					O			
Allyl Chloride Phenol							O		O			
Allyl Chloroformate							O					
Allyl Phenol	0	130	0	100	O							
Allylbenzene	20	60	0	100	O							
Alphamethylstyrene					O	O						
Alum	0	30	0	100	O	O			O			
Alum	30	98	0	100					O			
Alum	98	120	0	100								
Alumina					O	O			O			
Aluminum Chloride Aqueous	0	93	0	10	X	X	O	O	O	X	O	
Aluminum Chloride Aqueous	0	93	10	100	X	X	O	O	C	X	-	
Aluminum Chloride Aqueous	93	120	0	100	X	X	C	O	X	X	-	
Aluminum Chloride Dry	0	21	0	10	O	O	O	O	O	O	O	
Aluminum Chloride Dry	21	93	0	100	X	X	O	O	X	X	-	
Aluminum Chloride Dry	93	120	10	100	X	X	-	-	-	X	-	
Aluminum Chlorohydroxide							O					
Aluminum Fluorosulfate	0	200	0	15			O					
Aluminum Nitrate	0	98	0	100	O				O			
Aluminum Nitrate	98	120	0	100								

316 = 316L stainless steel
 304 = 304L stainless steel
 C22 = Nickel alloy C22
 B3 = Nickel alloy B3

TI = Titanium Grade 9
 ML = Alloy 400
 ZR = Zirconium Grade 702

See page 38 for material compatibility codes.

Material compatibility for fork density meters, viscosity meters

Fluid name	Temp (°C)		Conc. (%wt)		Material compatibility							
	Low	High	Low	High	316	304	C22	B3	TI	ML	ZR	Notes
Aluminum Oxide					O		O					
Aluminum Silicate												
Aluminum Sulfate	0	38	0	100			O		O			
Aluminum Sulfate	38	93	0	100					O			
Amine	0	100	0	100	O		O		O			
Amine	100	120	0	100								
Amine	120	148	0	100								
Ammonium Hydroxide	0	30	0	50	O	O	O	O	O	X	O	(Ammonia + Water)
Ammonium Hydroxide	30	70	0	30	O	O	O	O	-	X	O	(Ammonia + Water)
Ammonium Hydroxide	30	70	30	50	O	O	O	O	-	X	O	(Ammonia + Water)
Ammonium Hydroxide	70	150	0	50	-	-	O	O	-	X	O	(Ammonia + Water)
Ammonia					O	O	O	C	O	C	C	Anhydrous, gaseous
Ammonium Carbonate	0	20	0	30	O		O		O			
Ammonium Carbonate	20	93	0	30	O				O			
Ammonium Carbonate	93	120	0	30								
Ammonium Chloride	0	93	0	10	X	X	O	O	O	O	O	
Ammonium Chloride	0	82	0	50	X	X	O	O	O	O	O	
Ammonium Chloride	82	104	0	50	X	X	O	O	O	O	O	
Ammonium Chloride	104	120	0	50	X	X	O	O	O	-	O	
Ammonium Dihydrozene Phosphate							O					
Ammonium Laurate					O							
Ammonium Laureth Sulfate							O					
Ammonium Nitrate	0	93	0	100	O		O		O			
Ammonium Nitrate	93	120	0	100	O							
Ammonium Oxalate	0	24	0	10			O					
Ammonium Persulfate	0	25	0	5	O		O		O			
Ammonium Persulfate	0	25	5	10	O		O		O			
Ammonium Persulfate	0	60	10	100	O				O			
Ammonium Persulfate	60	120	10	100								
Ammonium Phosphate	0	60	0	10	O		O		O			
Ammonium Phosphate	0	60	10	100			O		O			
Ammonium Phosphate	60	104	0	10					O			
Ammonium Phosphate	60	120	10	100								
Ammonium Phosphate	104	120	0	10					O			
Ammonium Phosphate	120	148	10	100								
Ammonium Saltwater	20	80	0	15			O					
Ammonium Sulfate	0	104	0	10			O		O			
Ammonium Sulfate	0	120	10	100					O			
Ammonium Sulfate	104	120	0	10								

316 = 316L stainless steel
 304 = 304L stainless steel
 C22 = Nickel alloy C22
 B3 = Nickel alloy B3

TI = Titanium Grade 9
 ML = Alloy 400
 ZR = Zirconium Grade 702

See page 38 for material compatibility codes.

Material compatibility for fork density meters, viscosity meters

Fluid name	Temp (°C)		Conc. (%wt)		Material compatibility							
	Low	High	Low	High	316	304	C22	B3	TI	ML	ZR	Notes
Ammonium Sulfate	120	160	0	10								
Ammonium Sulfate	120	149	10	100								
Ammonium Sulfide	0	70	0	100				O				
Ammonium Sulfide	40	60	0	100				O				
Ammonium Thioglycolate					O			O				
Ammonium Thiosulfate								O		O		
Amyl Chloride	0	60	0	100	O	O	O	O	X	O	O	
Amyl Chloride	60	120	0	100	-	-	O	O	-	O	-	
Amyl Chloride	120	148	0	100	-	-	-	-	-	O	-	
Amyl Mercaptan	0	160	0	100				O				
Amylphenol	0	200	0	100				O				
Aniline	0	110	0	100	O				O			
Aniline	110	120	0	100	O			O				
Aniline	120	265	0	100	O							
Animal Fat								O		O		
Anodizing Solution Aluminum								O				
Anthracene Oil	80	90	0	100	O							
Anthraquinone												
Antibiotic Fermentation Media								O				
Antimony Pentachloride	0	71	0	50				O				
Apple Juice					O			O		O		
Aqua Quinine					O			O				
Aqua Regia	0	26			X	X	X	X	O	X	X	
Aqua Regia	26	120			X	X	X	X	X	X	X	
Argon					O			O		O		
Arsenic Acid	0	52	0	100	O							
Arsenic Acid	52	120	0	100								
Asphalt	0	60	0	100	O					O		
Asphalt	60	200	0	100	O					O		
Atropine	0	60	0	100				O				
Barium Sulfate	0	93	0	100				O		O		
Barium Sulfate	93	120	0	100								
Beef Tallow					O			O		O		
Beer	0	37	0	100	O			O		O		
Beer	37	150	0	100	O					O		
Beeswax Bleach Solution	0	104	0	100				O				
Benzene	0	116	0	100	O			O		O		
Benzene Hexachloride	0	200	0	100				O				
Benzoic Acid	0	82	0	10				O		O		
Benzoic Acid	0	104	10	100						O		

316 = 316L stainless steel
 304 = 304L stainless steel
 C22 = Nickel alloy C22
 B3 = Nickel alloy B3

TI = Titanium Grade 9
 ML = Alloy 400
 ZR = Zirconium Grade 702

See page 38 for material compatibility codes.

Material compatibility for fork density meters, viscosity meters

Fluid name	Temp (°C)		Conc. (%wt)		Material compatibility							
	Low	High	Low	High	316	304	C22	B3	TI	ML	ZR	Notes
Benzoic Acid	104	120	10	100								O
Benzophenone												O
Benzoquinine					O							O
Benzoyl Chloride												O
Benzoyl Peroxide												O
Benzyl Chloride	0	50	0	100								O
Benzyl Chloride	0	120	0	100								O
Black Acid	0	210	0	100								
Black Liquor	20	90	0	100	O							O
Bleach												O
Boric Acid	0	30	0	10	O							O
Boric Acid	0	120	0	10								O
Boric Acid	120	150	0	10								O
Boric Acid	150	250	0	10								O
Boron Sulfate												O
Boron Trifluoride												O
Boron Trifluoride Etherate	0	57	0	100								O
Brine												O
Bromethylbenzene												
Bromine	0	66	0	100	X	X	O	O	X	O	C	Dry gas
Bromine	0	20	0	100	X	X	O	X	O	X	O	Wet gas
Bromine	20	90	0	100	X	X	-	-	O	X	-	Wet gas
Butadiene	0	60	0	100	O							
Butadiene	60	120	0	100								O
Butane					O							O
Butanol					O							O
Butyl Acetate	0	120	0	100	O							O
Butyl Aldehyde					O							
Butylamine					O							O
Butylene Glycol												
Calcium Carbonate					O							O
Calcium Chloride	0	93	0	40	X	X	O	O	O	O	O	
Calcium Chloride	0	93	40	100	X	X	O	O	O	O	O	
Calcium Chloride	93	120	0	40	X	X	O	O	O	-	O	
Calcium Chloride	93	120	40	100	X	X	O	O	O	-	O	
Calcium Chloride	120	200	4	100	X	X	O	O	O	-	-	
Calcium Hydroxide	0	50	0	50	O							O
Calcium Hydroxide	0	100	0	50								O
Calcium Lignosulphonate												O
Calcium Pyridine Sulfonate	0	66	0	100								O

316 = 316L stainless steel
 304 = 304L stainless steel
 C22 = Nickel alloy C22
 B3 = Nickel alloy B3

TI = Titanium Grade 9
 ML = Alloy 400
 ZR = Zirconium Grade 702

See page 38 for material compatibility codes.

Material compatibility for fork density meters, viscosity meters

Fluid name	Temp (°C)		Conc. (%wt)		Material compatibility							
	Low	High	Low	High	316	304	C22	B3	TI	ML	ZR	Notes
Calcium Sulfide	0	47	0	100			O					
Canola Oil					O		O					
Carbolite					O		O					
Carbon Dioxide	0	120	0	100	O		O		O			Dry
Carbon Dioxide	0	120	0	100					O			
Carbon Disulfide	0	43	0	100	O				O			
Carbon Disulfide	43	65	0	100					O			
Carbon Disulfide	65	93	0	100					O			
Carbon Tetrachloride	0	60	0	100	O		O		O			Dry
Carbon Tetrachloride	60	120	0	100					O			Dry
Carbon Tetrachloride							O		O			Wet
Carbon Tetrafluoride												
Carbonic Acid									O		O	Wet
Carbochloric Acid									O			
Carboxylic Acid Salts									O			
Ceda Clean									O			
Cement					O				O			
Cerium Acetate									O			
Cetylpyridinium					O				O			
Cetylpyridinium Chloride									O			
Chloric Acid	0	31	0	20					O			
Chloric Acid	0	70	0	50								
Chlorinated Hydrocarbons									O			
Chlorinated Phenol									O			
Chlorinated Pyridine									O			
Chlorinated, Fluorinated Pyradines									O			
Chlorine	0	104	0	100	C	C	O	O	X	O	O	Dry gas
Chlorine	0	120	0	100	X	X	O	C	O	X	X	Wet gas
Chlorine	0	50	0	100	X	X	O	-	-	O	X	Liquid
Chlorine Dioxide									O			
Chloro Nitro Ethane									O			
Chloro Trifluoroethylene	0	49	0	100					O			
Chloroacetic Acid									O		O	
Chloroacetyl Chloride									O			
Chlorobenzene	0	38	0	60					O		O	
Chlorodifluoroethane									O			
Chlorodifluoromethane												
Chloroform	0	21	0	100	O				O			
Chloroform	21	95	0	100					O			

316 = 316L stainless steel
 304 = 304L stainless steel
 C22 = Nickel alloy C22
 B3 = Nickel alloy B3

TI = Titanium Grade 9
 ML = Alloy 400
 ZR = Zirconium Grade 702

See page 38 for material compatibility codes.

Material compatibility for fork density meters, viscosity meters

Fluid name	Temp (°C)		Conc. (%wt)		Material compatibility							
	Low	High	Low	High	316	304	C22	B3	TI	ML	ZR	Notes
Chloroform	95	104	0	100								O
Chlorophenol	0	60	0	5				O				
Chloropicrin	0	95	0	0				O				
Chlorosilane								O				
Chlorosulfonic Acid	0	85	0	100				O				
Chlorotetrahydrophthalic Anhydride								O				
Chocolate					O							O
Choline Chloride								O				
Chromic Oxide								O				Based on 50% chromic acid
Chromiumtrioxide			0	100						O		Chromic acid
Chromium Sulfate					O		O					
Citric Acid	0	100	0	50	O	C	O	O	O	O	O	
Citric Acid	100	120	0	50	X	X	O	O	X	X	O	
Coal Tar Fuel					O		O					
Coal Tar Pitch					O		O					
Cobalt Hydroxide	0	200	0	100								
Cobalt Octoate					O		O					
Cocoa Butter					O					O		
Coconut Oil					O					O		
Coke Gas Oil					O		O					
Compressed Natural Gas					O		O			O		
Concrete					O		O					
Copper Bromide												
Copper Sulfate	0	104	0	100				O		O		
Corn Oil					O		O			O		
Corn Oil and Garlic					O		O					
Corn Steep Liquor					O		O					
Corn Syrup					O		O			O		
Creosote Oil								O		O		
Cresol					O		O			O		
Cresylic Acid	0	100	0	100				O		O		
Crude Geranyl Ester					O		O					
Cupric Bromide	0	30	0	100								
Cupric Chloride	0	104	0	5	X	X	O	-	O	X	X	
Cupric Chloride	0	21	5	50	X	X	O	O	O	X	X	
Cupric Chloride	21	120	5	50	X	X	C	-	O	X	X	
Cyanogen Chloride	0	46	0	20				O				
Cyclohexane	0	93	0	100	O					O		
Cyclohexane	93	120	0	100	O					O		

316 = 316L stainless steel
 304 = 304L stainless steel
 C22 = Nickel alloy C22
 B3 = Nickel alloy B3

TI = Titanium Grade 9
 ML = Alloy 400
 ZR = Zirconium Grade 702

See page 38 for material compatibility codes.

Material compatibility for fork density meters, viscosity meters

Fluid name	Temp (°C)		Conc. (%wt)		Material compatibility							
	Low	High	Low	High	316	304	C22	B3	TI	ML	ZR	Notes
Cyclopropylamine					○	○						
Decane Sulfonyl Fluoride												
Diacryl Phthalate	0	15	0	100	○							
Dibromobenzene	0	200	0	100								
Dichloroacetyl Chloride												
Dichlorobenzene								○				
Dichlorobutene								○				
Dichlorodifluoromethane	0	21	0	100			○		○			
Dichlorodifluoromethane	21	71	0	100								
Dichlorofluoroethane							○		○			
Dichlorophenol	0	120	0	100			○					
Dichlorotrifluoroethane												
Diesel Fuel	0	38	0	100	○	○						
Diesel Fuel	38	120	0	100	○	○						
Diethanolamine	0	100	0	100	○	○			○			
Diethyl Aluminum Chloride												
Diethyl Disulfide	0	90	0	100			○					
Diethyl Sulfate								○				
Diethyl Sulfide								○				
Diethylamine	0	120	0	100	○							
Diethylene Glycol	0	52	0	100	○				○			
Diethylene Glycol	52	76	0	100	○				○			
Difluorobenzonitrile												
Difluoromonochlorethane								○				
Dihydrogen Sulfide								○				
Diisononylphthalate					○	○						
Diisopropyl Peroxydicarbonate					○	○						
Dimethyl Aminoethyl Methacrylate					○							
Dimethyl Chloride								○				
Dimethyl Dichloride								○				
Dimethyl Formaldehyde					○							
Dimethyl Hydrazine					○	○						
Dimethyl Malonate	0	100	0	100			○					
Dimethyl Succinate			0	100	○	○						
Dimethyl Sulfate					○	○						
Dimethyl Sulfide					○	○						
Dimethyl Terephthalate					○							
Dimethylacetamide	0	200	0	100								
Dimethylamine	25	180	0	100	○							

316 = 316L stainless steel
 304 = 304L stainless steel
 C22 = Nickel alloy C22
 B3 = Nickel alloy B3

TI = Titanium Grade 9
 ML = Alloy 400
 ZR = Zirconium Grade 702

See page 38 for material compatibility codes.

Material compatibility for fork density meters, viscosity meters

Fluid name	Temp (°C)		Conc. (%wt)		Material compatibility							
	Low	High	Low	High	316	304	C22	B3	TI	ML	ZR	Notes
Dimethylpolysiloxanes					○		○					
Dinitrotoluene					○		○					
Diphenyl Methane					○		○					
Diisocyanate												
Diphenylamine	0	100	0	100			○					
Dipropyl Peroxydicarbonate					○		○					
Disobutylene					○		○					
Disodium Iminodiacetate												
Divinylbenzene					○		○					
Dodecyl Mercaptan					○		○					
Dodecylbenzene Sulfonic Acid								○				
Drilling Mud					○		○		○			
Egg Slurry					○		○		○			
Epichlorohydrine	0	60	0	100	○		○					Dry
Epoxy Resin					○		○		○			
Ercimide							○					
Ester Vinyl Ether							○					
Ether	20	100	0	100	○				○			
Ethyl Acetate	20	65	0	100	○		○		○			
Ethyl Alcohol					○				○			
Ethyl Benzene	0	60	0	100	○		○					
Ethyl Benzene	60	100	0	100	○		○					
Ethyl Monochloroacetate								○				
Ethylbenzene Sulfonyl Fluoride								○				
Ethylene					○		○					Gas
Ethylene Chlorohydrin	0	100	0	100			○					
Ethylene Diamine	0	37	0	100	○				○			
Ethylene Diamine	37	43	0	100								
Ethylene Dichloride	0	93	0	100	○	○	○	○	○	○	C	
Ethylene Glycol	0	120	0	100	○		○		○			
Ethylene Glycol	120	200	0	100			○					
Ethylene Glycol/Bromoform				97								
Ethylene Oxide	0	31	0	100	○		○		○			
Ethylene Oxide	31	120	0	100	○							
Ethylproplacrolein					○		○					
Evaposhine							○					
Fat/Garlic					○		○		○			
Fatty Acid	0	120	0	100	○		○		○			
Fatty Acid	120	200	0	100	○		○					
Ferric Chloride	0	25	0	10			○		○			

316 = 316L stainless steel
 304 = 304L stainless steel
 C22 = Nickel alloy C22
 B3 = Nickel alloy B3

TI = Titanium Grade 9
 ML = Alloy 400
 ZR = Zirconium Grade 702

See page 38 for material compatibility codes.

Material compatibility for fork density meters, viscosity meters

Fluid name	Temp (°C)		Conc. (%wt)		Material compatibility							
	Low	High	Low	High	316	304	C22	B3	TI	ML	ZR	Notes
Ferric Chloride		80		100								O
Ferric Nitrate	0	20	0	100			O					O
Ferric Nitrate	20	120	0	100								O
Ferric Nitrite					O		O					
Ferric Sulfate	0	60	0	10	O		O					O
Ferric Sulfate	0	60	10	30			O					O
Ferric Sulfate	0	98	30	100								O
Ferric Sulfate	60	98	0	10								O
Ferric Sulfate	60	98	10	30								O
Ferrous Chloride	0	25	0	10			O					
Ferrous Chloride	0	120	0	100								O
Ferrous Sulfate	0	120	0	100			O					O
Fluorine					C	O	O	-	X	O	X	Dry gas
Fluorine					X	X	O	-	X	C	X	Wet gas
Fluoroalcohol												
Fluorobenzene												
Fluorosulfonic Acid												
Fluorotrichloromethane												
Food Product							O			O		
Formaldehyde					O							
Formic Acid	0	30	0	10	O	O	O	O	O	O	O	
Formic Acid	0	100	0	5	O	O	O	O	O	O	O	
Formic Acid	0	100	10	85	O	C	O	C	C	O	O	
Formic Acid	100	116	0	5	O	X	O	O	O	O	O	
Formic Acid	116	153	0	5	X	X	-	O	O	-	-	
Fruit Juice					O		O			O		
Gasoline	0	43	0	100	O		O			O		
Gasoline	43	120	0	100			O					
Gelatin					O					O		
Glycerine	0	104	0	100	O		O			O		
Glycolite					O		O					
Glyoxalic Acid	0	50					O					
Green Liquor							O					
Halogenated Alkyl Ether												
Halogenated Alkyl Ether							O					
Halogenated Styrene							O					
Helium					O		O			O		
Heptane	0	60	0	100	O		O			O		

316 = 316L stainless steel
 304 = 304L stainless steel
 C22 = Nickel alloy C22
 B3 = Nickel alloy B3

TI = Titanium Grade 9
 ML = Alloy 400
 ZR = Zirconium Grade 702

See page 38 for material compatibility codes.

(1) Refer to page 32 for additional information about HCl.

Material compatibility for fork density meters, viscosity meters

Fluid name	Temp (°C)		Conc. (%wt)		Material compatibility								Notes
	Low	High	Low	High	316	304	C22	B3	TI	ML	ZR		
Heptane	60	98	0	100				O		O			
Hexachlorocyclopentadiene													Chlorinated cyclic olefin (C5Cl6)
Hexafluoropropene										O			
Hexahydrophthalic Anhydride						O			O				
Hexamethylenediisocyanate										O			
Hexane						O			O		O		
Hydrazine						O			O				
Hydrobromic Acid													
Hydrochloric Acid ⁽¹⁾	0	90	0	5	X	X	O	C	C	X	O		Consult MMI before using B3, ML or ZR when oxidizing impurities such as ferric ions (Fe ⁺³) or cupric ions (Cu ⁺²) are present.
Hydrochloric Acid ⁽¹⁾	0	49	5	38	X	X	O	O	C	X	O		Consult MMI before using B3, ML or ZR when oxidizing impurities such as ferric ions (Fe ⁺³) or cupric ions (Cu ⁺²) are present.
Hydrochloric Acid ⁽¹⁾	49	191	5	100	X	X	X	C	X	X	C		Consult MMI before using B3, ML or ZR when oxidizing impurities such as ferric ions (Fe ⁺³) or cupric ions (Cu ⁺²) are present.
Hydrochloric Acid ⁽¹⁾	38	71	100	100	X	X	X	O	X	X	-		Consult MMI before using B3, ML or ZR when oxidizing impurities such as ferric ions (Fe ⁺³) or cupric ions (Cu ⁺²) are present.
Hydrochloric Acid Slurry ⁽¹⁾			0	15	X	X	O	O	-	-	O		Consult MMI before using B3, ML or ZR when oxidizing impurities such as ferric ions (Fe ⁺³) or cupric ions (Cu ⁺²) are present.
Hydrofluoric Acid	0	21	0	10	C	C	C	O	X	O	X		Aqueous. Consult MMI before using B3, ML or ZR when oxidizing impurities such as ferric ions (Fe ⁺³) or cupric ions (Cu ⁺²) are present.
Hydrofluoric Acid	21	120	10	100	C	X	C	C	X	C	X		Aqueous. Consult MMI before using B3, ML or ZR when oxidizing impurities such as ferric ions (Fe ⁺³) or cupric ions (Cu ⁺²) are present.
Hydrofluosilicic Acid			10	50									

316 = 316L stainless steel
 304 = 304L stainless steel
 C22 = Nickel alloy C22
 B3 = Nickel alloy B3

TI = Titanium Grade 9
 ML = Alloy 400
 ZR = Zirconium Grade 702

See page 38 for material compatibility codes.

Material compatibility for fork density meters, viscosity meters

Fluid name	Temp (°C)		Conc. (%wt)		Material compatibility							
	Low	High	Low	High	316	304	C22	B3	TI	ML	ZR	Notes
Hydrogen	0	120	0	100	O	O	O	O	O	O	–	
Hydrogen	120	200	0	100	O	O	O	O	O	O	–	
Hydrogen Bromide												
Hydrogen Chloride					O	O	O	O	C	C	O	Dry gas
Hydrogen Chloride					C	C	X	O	–	X	–	Wet gas
Hydrogen Cyanide	0	31	0	100	O		O		O			
Hydrogen Cyanide	31	53	0	100			O					
Hydrogen Cyanide	53	120	0	100								
Hydrogen Fluoride	0	43	0	100	O	O	O	O	O	O	O	Dry gas
Hydrogen Peroxide	0	90	0	5	O	O	O	C	O	X	O	
Hydrogen Peroxide	0	90	0	50	O	O	O	C	O	C	O	
Hydrogen Peroxide	0	48	50	90	O	O	O	C	O	C	O	
Hydrogen Sulfide	0	31	0	100	O		O		O			Dry gas
Hydrogen Sulfide	0	38	0	100			O		O			Wet gas
Hydrogen Sulfide	31	82	0	100	O		O					Dry gas
Hydrogen Sulfide	38	120	0	100								Wet gas
Hydrogen Sulfide	82	120	0	100								Dry gas
Hydrogen Sulfide									O			Aqueous solution
Hydroquinone					O		O					
Hydroxymethyl Ester					O		O					
Hydroxyphenylethanone					O		O					
Hydroxypropylmethylcellulose												Opadry
Hypochlorite							O					
Hypochlorous Acid							O		O			
Ice Cream					O		O		O			
Igepon Surfactant					O		O					
Ink					O				O			
Insulin Extract							O					
Iron Sulfate							O					
Isobutanol					O				O			
Isobutyl Acetate					O							
Isooctyl Alcohol					O		O					
Isopar E					O		O					
Isopentane					O		O					
Isopropyl Acetate					O		O					
Isopropyl Alcohol					O		O		O			
Isopropylamine					O		O					
Jet Fuel	0	30	0	100	O		O		O			
Kathon Lx 1.5% Biocide							O					
Kerosene					O		O		O			

316 = 316L stainless steel
 304 = 304L stainless steel
 C22 = Nickel alloy C22
 B3 = Nickel alloy B3

TI = Titanium Grade 9
 ML = Alloy 400
 ZR = Zirconium Grade 702

See page 38 for material compatibility codes.

Material compatibility for fork density meters, viscosity meters

Fluid name	Temp (°C)		Conc. (%wt)		Material compatibility							Notes
	Low	High	Low	High	316	304	C22	B3	TI	ML	ZR	
Ketchup					O				O			
Lactic Acid	0	49	0	10	O				O			
Lactic Acid	0	49	10	25	O				O			
Lactic Acid	49	104	0	10					O			
Lactic Acid	49	60	10	25					O			
Lactic Acid	104	120	0	10						O		
Lactic Acid			25	100							O	
Lactose	0	100	0	100	O							
Laoquer Thinner/Lupranate					O				O			
Lard Oil					O				O			
Lasso Herbicide												
Latex	0	60	0	100	O					O		
Latex Emulsion					O				O			
Lauryl Bromide									O			
Lead Acetate	0	104	0	100	O				O			
Lime Slurry	0	55	0	100					O			
Limestone	0	49	0	8	O				O			Maintain velocity < 10ft/sec
Liquefied Petroleum Gas					O				O			
Lithium Bromide					O	X	O	O	O	O	-	
Lithium Chloride	0	100	0	60	C	C	O	O	O	O	-	
Magnesium Chloride	0	120	0	100	X	X	O	O	O	C	-	
Magnesium Chloride	120	153	50	100	X	X	O	O	-	C	-	
Magnesium Hydroxide	0	100	0	100	O				O			
Magnesium Hydroxide	100	120	0	100								
Magnesium Nitrate	0	93	0	100	O				O			
Magnesium Oxide					O				O			
Magnesium Silicate					O				O			
Magnesium Sulfate	0	93	0	50					O			
Magnetic Slurries									O			
Maleic Acid	0	80	0	100	O				O			
Maleic Acid	80	120	0	100						O		
Maleic Anhydride					O				O			
Malumar					O				O			
Manganese Cobalt Acetate					O				O			
Manganese Sulfate	0	63	0	100					O			
Mayonnaise					O				O			
Mercaptan					O				O			
Mercapto Ethanol					O				O			
Methacrylic Acid					O				O			
Methane					O				O			

316 = 316L stainless steel
 304 = 304L stainless steel
 C22 = Nickel alloy C22
 B3 = Nickel alloy B3

TI = Titanium Grade 9
 ML = Alloy 400
 ZR = Zirconium Grade 702

See page 38 for material compatibility codes.

Material compatibility for fork density meters, viscosity meters

Fluid name	Temp (°C)		Conc. (%wt)		Material compatibility							
	Low	High	Low	High	316	304	C22	B3	TI	ML	ZR	Notes
Methanol	0	100	0	100	O	O			X			
Methyl Acetate	0	60	0	60	O	O						
Methyl Acrylate					O	O						
Methyl Acrylic Acid							O					
Methyl Alcohol	0	100	0	100	O	O	O	O	X	O	O	
Methyl Benzimidazole Zinc Salt							O					
Methyl Bromide	0	20	0	100	O	O	O	O	O	C	-	
Methyl Bromide	20	120	0	100	-	-	O	O	-	-	-	
Methyl Chloride	0	120	0	100	O	O	O	X	O	X	-	Dry
Methyl Chloride	0	104	0	100	X	X	O	O	O	-	-	Wet
Methyl Ethyl Ketone	0	93	0	100	O	O			O			
Methyl Iodide												
Methyl Methacrylate					O	O						
Methylamine					O							
Methyldichlorosilane							O					
Methylene Chloride	0	30			O	O			O			Dry
Methylene Chloride	0	30	0	100					O			
Methylene Chloride	0	120	0	100					O			
Methylpyrrolidone					O	O						
Mineral Oil					O	O			O			
Mineral Spirits					O	O						
Molasses					O	O			O			
Monochlorobenzene							O					
Monochlorodifluoromethane					O	O			O			
Monoethanoamine Hydrochloride	0	65	0	100			O					
Monoethanol Amine							O		O			
Monoethanolamine	0	100	0	90	O	O			O			
Morpholine					O	O						
Musk Concentrate					O	O						
Mustard Gas												
Nadir Methyl Anhydride					O	O						
Nalco 625							O					
Naphtha					O	O			O			
Naphthalene	0	120	0	100	O	O			O			
Naphthalene Sulfonic Acid	0	200	0	100			O					
Neopentyl Glycol							O					
Nickel Chloride	0	90	0	100			O		O			

316 = 316L stainless steel
 304 = 304L stainless steel
 C22 = Nickel alloy C22
 B3 = Nickel alloy B3

TI = Titanium Grade 9
 ML = Alloy 400
 ZR = Zirconium Grade 702

See page 38 for material compatibility codes.

(1) Refer to page 34 for additional information about HNO₃.

Material compatibility for fork density meters, viscosity meters

Fluid name	Temp (°C)		Conc. (%wt)		Material compatibility							
	Low	High	Low	High	316	304	C22	B3	TI	ML	ZR	Notes
Nickel Slurry					O		O					
Nitric Acid ⁽¹⁾	-18	10	0	70	O	O	O	C	O	X	O	
Nitric Acid ⁽¹⁾	-18	10	70	90	O	O	O	X	X	X	O	
Nitric Acid ⁽¹⁾	-18	10	90	100	O	O	X	X	X	X	X	
Nitric Acid ⁽¹⁾	10	24	0	70	O	O	O	C	O	X	O	
Nitric Acid ⁽¹⁾	10	24	70	90	O	O	C	X	X	X	O	
Nitric Acid ⁽¹⁾	10	24	90	100	O	O	C	X	X	X	X	
Nitric Acid ⁽¹⁾	24	38	0	20	O	O	O	C	O	X	O	
Nitric Acid ⁽¹⁾	24	38	20	50	O	O	O	C	O	X	O	
Nitric Acid ⁽¹⁾	24	38	50	70	O	O	O	C	O	X	O	
Nitric Acid ⁽¹⁾	24	38	70	90	C	O	X	C	X	X	O	
Nitric Acid ⁽¹⁾	24	38	90	100	C	O	X	X	X	X	X	
Nitric Acid ⁽¹⁾	38	52	0	10	O	O	O	C	O	X	O	
Nitric Acid ⁽¹⁾	38	52	10	40	O	O	O	C	O	X	O	
Nitric Acid ⁽¹⁾	38	52	40	70	O	O	C	C	O	X	O	
Nitric Acid ⁽¹⁾	38	52	70	80	O	O	C	C	X	X	O	
Nitric Acid ⁽¹⁾	38	52	80	90	C	C	X	X	X	X	O	
Nitric Acid ⁽¹⁾	38	52	90	100	X	C	X	X	X	X	X	
Nitric Acid ⁽¹⁾	52	66	0	30	O	O	O	C	O	X	O	
Nitric Acid ⁽¹⁾	52	66	30	70	C	O	O	C	O	X	O	
Nitric Acid ⁽¹⁾	52	66	70	90	X	C	X	X	X	X	O	
Nitric Acid ⁽¹⁾	52	66	90	100	X	C	X	X	X	X	X	
Nitric Acid ⁽¹⁾	66	80	0	20	O	O	C	C	X	X	O	
Nitric Acid ⁽¹⁾	66	80	20	45	O	O	X	C	X	X	O	
Nitric Acid ⁽¹⁾	66	80	45	55	O	O	X	X	X	X	O	
Nitric Acid ⁽¹⁾	66	80	55	90	X	C	X	X	X	X	O	
Nitric Acid ⁽¹⁾	66	80	90	100	X	C	X	X	X	X	X	
Nitric Acid ⁽¹⁾	80	93	0	45	C	O	C	C	X	X	O	
Nitric Acid ⁽¹⁾	80	90	45	90	X	C	X	X	X	X	O	
Nitric Acid ⁽¹⁾	80	93	90	100	X	C	X	X	X	X	X	
Nitric Acid ⁽¹⁾	93	163	0	90	X	C	X	X	X	X	O	
Nitric Acid ⁽¹⁾	93	163	90	100	X	C	X	X	X	X	X	
Nitroaniline							O					
Nitrobenzene					O		O		O			
Nitrochlorobenzene							O					
Nitrogen					O		O		O			
Nonanoic Acid Sludge							O					
Nonyl Phenol					O		O					
Octanol					O		O					
Oil Emulsion					O		O		O			

316 = 316L stainless steel
 304 = 304L stainless steel
 C22 = Nickel alloy C22
 B3 = Nickel alloy B3

TI = Titanium Grade 9
 ML = Alloy 400
 ZR = Zirconium Grade 702

See page 38 for material compatibility codes.

Material compatibility for fork density meters, viscosity meters

Fluid name	Temp (°C)		Conc. (%wt)		Material compatibility								
	Low	High	Low	High	316	304	C22	B3	TI	ML	ZR	Notes	
Oil, Crude					O				O				
Oil, Fuel					O				O				
Oil, Gas					O				O				
Oil, Hydraulic Cylinder					O				O				
Oil, Lube					O				O				
Oil, Soybean					O				O				
Oil, Spindle					O				O				
Oil, Transformer					O				O				
Oil, Turpentine					O				O				
Oil, Vegetable	0	43	0	100	O				O				
Oil, Vegetable	43	104	0	100	O								
Oil, Waste									O				
Oleum	20	50	0	100					O				
Orange Juice					O					O			
Oxalic Acid	0	104	0	10					O				
Oxygen					O				O				
Ozonated Water					O					O			
Ozone					O				O				
Paint					O				O				
Palmitic Acid					O								
Paper Pulp	0	74	0	15					O			Chlorine bleached	
Paraffine					O					O			
Paranitrochlorinebenzene													
Pentamethyl Indan					O				O				
Pentane					O				O				
Perchloroethylene					O				O				
Perfluorochemical Inert Liquid													
Peroxide Acid									O				
Phenol			0	95					O				
Phenol					O				O				
Phenol Formaldehyde	0	130	0	100					O				
Phenolsulfonic Acid					O				O				
Phenothiazine					O				O				
Phosgene	20	65	0	100					O				
Phosphoric Acid	0	25	0	85	O	O	O	O	O	C	X	C	Food Grade (Thermal Process). Do not use B3 or ML when ferric ions or dissolved oxygen are present.
Phosphoric Acid	0	100	0	5	O	O	O	O	O	C	X	O	(Wet Process). Do not use B3 or ML when ferric ions or dissolved oxygen are present.

316 = 316L stainless steel
 304 = 304L stainless steel
 C22 = Nickel alloy C22
 B3 = Nickel alloy B3

TI = Titanium Grade 9
 ML = Alloy 400
 ZR = Zirconium Grade 702

See page 38 for material compatibility codes.

Material compatibility for fork density meters, viscosity meters

Fluid name	Temp (°C)		Conc. (%wt)		Material compatibility								Notes
	Low	High	Low	High	316	304	C22	B3	TI	ML	ZR		
Phosphoric Acid	0	100	5	50	O	X	O	O	C	X	O	(Wet Process). Do not use B3 or ML when ferric ions or dissolved oxygen are present.	
Phosphoric Acid	0	100	50	98	O	X	O	O	X	X	X	(Wet Process). Do not use B3 or ML when ferric ions or dissolved oxygen are present.	
Phosphoric Acid	0	80	98	100	O	X	X	O	X	X	X	(Wet Process). Do not use B3 or ML when ferric ions or dissolved oxygen are present.	
Phosphoric Acid/Sodium Hydroxide								O					
Phosphorous								O					
Phosphorous Acid								O					
Phosphorous Oxychloride													
Phosphorous Trichloride										O			
Phthalic Acid					O		O		O				
Phthalic Anhydride	-18	99	98	100	O		O						
Phthalic Anhydride	99	149	98	100	O		O						
Phthalic Anhydride	149	204	98	100	O		O						
Phthalic Anhydride/Thermon								O					
Picric Acid					O		O		O				
Pitch	100	200	0	100	O				O				
Pivalic Acid					O		O						
Platinum Chloride													
Polyacrylamide					O		O						
Polyamine	0	182	0	100				O					
Polybutyl Chloride								O					
Polydimethylaminetetra-chlorohydrate								O					
Polyester					O		O						
Polyethylene					O		O						
Polyethylene Glycol					O		O		O				
Polyethylene Wax					O		O		O				
Polyisobutylene					O		O						
Polyol					O		O						
Polyphosphorous								O					
Polyvinyl Alcohol					O		O						
Potassium Acetate													
Potassium Bisulfite	0	63	0	100				O					
Potassium Bromide	0	31	0	30	X	X	O	O	O	X	O		
Potassium Bromide	0	104	30	50	X	X	O	C	O	X	O		

316 = 316L stainless steel
 304 = 304L stainless steel
 C22 = Nickel alloy C22
 B3 = Nickel alloy B3

TI = Titanium Grade 9
 ML = Alloy 400
 ZR = Zirconium Grade 702

See page 38 for material compatibility codes.

Material compatibility for fork density meters, viscosity meters

Fluid name	Temp (°C)		Conc. (%wt)		Material compatibility							
	Low	High	Low	High	316	304	C22	B3	TI	ML	ZR	Notes
Potassium Bromide	0	104	50	100	X	X	O	C	O	X	-	
Potassium Carbonate					O		O		O			
Potassium Carbonate							O		O			
Potassium Chloride	0	110	0	99	X	X	O	O	O	O	O	
Potassium Chloride	110	160	0	99	X	X	O	O	O	O	O	
Potassium Chromate	0	24	0	10			O					
Potassium Hydroxide	0	93	0	40	O	O	O	O	C	O	O	
Potassium Hydroxide	0	100	40	50	X	O	O	O	C	O	O	
Potassium Iodide					O	O	O	O	O	O	O	
Potassium Nitrate	0	100					O		O			
Potassium Permanganate	0	100	0	50			O		O			
Potassium Persulfate	0	24	0	4			O					
Potassium Persulfate					O							
Primary Stearyl Amine					O		O					
Propane					O		O		O			
Propionic Acid	0	140	0	97			O					
Propyl Alcohol	0	104	0	100	O		O		O			
Propylene					O		O		O			
Propylene Glycol					O		O		O			
Propylene Oxide					O		O					
Pyridine												
Rhodium					O		O					
Rosin	0	200	0	100			O					
Roundup Herbicide							O					
Rubber Cement					O		O					
Rubber Hydrocarbon					O		O					
Safety-kleen 105					O		O					
Salicylic Acid	0	120	0	100			O		O			
Scalp Oil							O		O			
Sebacic Acid	0	104	0	10			O					
Sentol (Liquid Acid Cleaner)							O					
Silica Slurry					O		O					
Silicon Dioxide					O		O					
Silicon Tetrafluoride												
Silicone					O		O		O			
Silicone Oil					O		O		O			
Silicontetrachloride Slurry					O		O					
Silver Nitrate					O		O		O			

316 = 316L stainless steel
 304 = 304L stainless steel
 C22 = Nickel alloy C22
 B3 = Nickel alloy B3

TI = Titanium Grade 9
 ML = Alloy 400
 ZR = Zirconium Grade 702

See page 38 for material compatibility codes.

(1) Refer to page 33 for additional information about NaOH.

Material compatibility for fork density meters, viscosity meters

Fluid name	Temp (°C)		Conc. (%wt)		Material compatibility							
	Low	High	Low	High	316	304	C22	B3	TI	ML	ZR	Notes
Soap Fat	0	200	0	100			O		O			
Soap Solution					O		O		O			
Sodium Alkyl Glyceryl Sulfonate							O					
Sodium Aluminate					O		O		O			
Sodium Bicarbonate			0	20	O		O		O			
Sodium Bicarbonate			20	100					O			
Sodium Bisulfate	0	82	0	20			O		O			
Sodium Bisulfite							O					
Sodium Carbonate	0	100	0	25	O	O	O	O	O	O	O	
Sodium Carbonate	0	100	25	100	O	O	O	O	O	O	O	
Sodium Carbonate/Sulfuric Acid					O		O					
Sodium Chlorate	0	104	0	70	O	O	O	C	O	O	-	
Sodium Chlorate	60	150	70	100	X	X	O	C	O	X	-	
Sodium Chloride	0	60	0	100	X	X	O	O	O	O	O	
Sodium Cyanide	0	38	0	10	O		O		O			
Sodium Cyanide	0	120	0	100								
Sodium Formaldehyde					O		O					
Sodium Formaldehyde Bisulfate					O		O					
Sodium Formaldehyde sulfoxylate							O					
Sodium Gluconate					O		O					
Sodium Hydrosulfate					O		O					
Sodium Hydrosulfide												
Sodium Hydrosulfide							O					
Sodium Hydrosulfite					O		O					
Sodium Hydroxide ⁽¹⁾	0	53	0	15	O	O	O	O	O	O	O	Observe chloride limits of Fig 2 for 316L and 304L
Sodium Hydroxide ⁽¹⁾	0	53	15	20	O	O	O	O	O	O	O	Observe chloride limits of Fig 2 for 316L and 304L
Sodium Hydroxide ⁽¹⁾	0	53	20	50	O	O	O	O	O	O	O	Observe chloride limits of Fig 2 for 316L and 304L
Sodium Hydroxide ⁽¹⁾	53	86	0	50	O	O	O	O	O	O	O	Observe chloride limits of Fig 2 for 316L and 304L
Sodium Hydroxide ⁽¹⁾	86	120	0	100	C	C	C	O	X	C	C	Observe chloride limits of Fig 2 for 316L and 304L
Sodium Hypochlorite	0	30	0	1	O	X	O	X	O	X	O	
Sodium Hypochlorite	30	60	0	16	X	X	O	X	O	X	O	
Sodium Hypochlorite	60	120	0	16	X	X	X	X	C	X	O	
Sodium Hypophosphite					O		O					
Sodium Metabisulfite							O					
Sodium Metal							O					

316 = 316L stainless steel
 304 = 304L stainless steel
 C22 = Nickel alloy C22
 B3 = Nickel alloy B3

TI = Titanium Grade 9
 ML = Alloy 400
 ZR = Zirconium Grade 702

See page 38 for material compatibility codes.

Material compatibility for fork density meters, viscosity meters

Fluid name	Temp (°C)		Conc. (%wt)		Material compatibility							
	Low	High	Low	High	316	304	C22	B3	TI	ML	ZR	Notes
Sodium Nitrate	0	112	0	60	O	O			O			
Sodium Nitrate	0	120	60	100					O			
Sodium Nitrite								O	O			
Sodium Omandine												
Sodium Perchlorate	0	65	0	100				O				
Sodium Persulfate								O				
Sodium Phenolate	0	120	0	100				O				
Sodium Phosphate	0	100						O	O			
Sodium Polyphosphate								O				
Sodium Silicate					O			O	O			
Sodium Sulfate	0	100	0	20	O			O	O			
Sodium Sulfide	0	120	0	50				O	O			
Sodium Sulfite	0	120	0	10				O	O			
Sodium Xylene Sulphonate					O			O				
Soy Oil					O			O	O			
Soy Protein			0	18				O	O			
Soy Sauce								O	O			
Spent Acid												
Stannic Chloride								O	O			
Stannous Chloride	0	75	0	10	O			O	O			
Stannous Chloride	0	120	10	100				O				
Starch Syrup					O			O				
Stearic Acid					O			O	O			
Styrene					O			O				
Sucrose	0	93	0	62	O			O				
Sulfamic Acid	0	30			O			O				
Sulfite Liquor								O	O			
Sulfolane					O			O				
Sulfonic Acid								O				
Sulfonylchloride								O				
Sulfur	0	120	0	100	O			O	O			Molten
Sulfur Dichloride								O				
Sulfur Dioxide					O			O	O			Dry
Sulfur Dioxide								O				Wet
Sulfur Monochloride/Isobutylene												
Sulfur Trioxide	0	25	0	100				O				

316 = 316L stainless steel
 304 = 304L stainless steel
 C22 = Nickel alloy C22
 B3 = Nickel alloy B3

TI = Titanium Grade 9
 ML = Alloy 400
 ZR = Zirconium Grade 702

See page 38 for material compatibility codes.

(1) Refer to page 34 for additional information about H₂SO₄.

Material compatibility for fork density meters, viscosity meters

Fluid name	Temp (°C)		Conc. (%wt)		Material compatibility								Notes
	Low	High	Low	High	316	304	C22	B3	TI	ML	ZR		
Sulfuric Acid ⁽¹⁾	-18	24	0	20	O	X	O	O	C	C	O	Do not use B3, ML, or ZR when oxidizing impurities such as ferric ions, cupric ions or dissolved oxygen are present.	
Sulfuric Acid ⁽¹⁾	-18	24	20	65	X	X	O	O	X	C	O	Do not use B3, ML, or ZR when oxidizing impurities such as ferric ions, cupric ions or dissolved oxygen are present.	
Sulfuric Acid ⁽¹⁾	-18	24	65	75	X	X	O	O	X	C	C	Do not use B3, ML, or ZR when oxidizing impurities such as ferric ions, cupric ions or dissolved oxygen are present.	
Sulfuric Acid ⁽¹⁾	-18	24	75	98	C	C	O	O	X	C	X	Do not use B3, ML, or ZR when oxidizing impurities such as ferric ions, cupric ions or dissolved oxygen are present.	
Sulfuric Acid ⁽¹⁾	24	38	0	10	O	X	O	O	C	-	O	Do not use B3, ML, or ZR when oxidizing impurities such as ferric ions, cupric ions or dissolved oxygen are present.	
Sulfuric Acid ⁽¹⁾	24	38	10	40	X	X	O	O	X	C	O	Do not use B3, ML, or ZR when oxidizing impurities such as ferric ions, cupric ions or dissolved oxygen are present.	
Sulfuric Acid ⁽¹⁾	24	38	40	75	X	X	O	O	X	C	C	Do not use B3, ML, or ZR when oxidizing impurities such as ferric ions, cupric ions or dissolved oxygen are present.	
Sulfuric Acid ⁽¹⁾	24	38	75	85	O	X	O	O	X	C	X	Do not use B3, ML, or ZR when oxidizing impurities such as ferric ions, cupric ions or dissolved oxygen are present.	
Sulfuric Acid ⁽¹⁾	24	38	85	93	O	X	O	O	X	X	X	Do not use B3, ML, or ZR when oxidizing impurities such as ferric ions, cupric ions or dissolved oxygen are present.	

316 = 316L stainless steel
 304 = 304L stainless steel
 C22 = Nickel alloy C22
 B3 = Nickel alloy B3

TI = Titanium Grade 9
 ML = Alloy 400
 ZR = Zirconium Grade 702

See page 38 for material compatibility codes.

(1) Refer to page 34 for additional information about H₂SO₄.

Material compatibility for fork density meters, viscosity meters

Fluid name	Temp (°C)		Conc. (%wt)		Material compatibility								Notes
	Low	High	Low	High	316	304	C22	B3	TI	ML	ZR		
Sulfuric Acid ⁽¹⁾	24	38	93	98	O	O	O	O	X	X	X	Do not use B3, ML, or ZR when oxidizing impurities such as ferric ions, cupric ions or dissolved oxygen are present.	
Sulfuric Acid ⁽¹⁾	38	52	0	5	O	X	O	O	C	-	O	Do not use B3, ML, or ZR when oxidizing impurities such as ferric ions, cupric ions or dissolved oxygen are present.	
Sulfuric Acid ⁽¹⁾	38	52	5	25	C	X	O	O	X	C	O	Do not use B3, ML, or ZR when oxidizing impurities such as ferric ions, cupric ions or dissolved oxygen are present.	
Sulfuric Acid ⁽¹⁾	38	52	25	75	X	X	C	O	X	C	C	Do not use B3, ML, or ZR when oxidizing impurities such as ferric ions, cupric ions or dissolved oxygen are present.	
Sulfuric Acid ⁽¹⁾	38	52	75	90	C	-	O	O	X	C	X	Do not use B3, ML, or ZR when oxidizing impurities such as ferric ions, cupric ions or dissolved oxygen are present.	
Sulfuric Acid ⁽¹⁾	38	52	90	98	-	C	O	O	X	X	X	Do not use B3, ML, or ZR when oxidizing impurities such as ferric ions, cupric ions or dissolved oxygen are present.	
Sulfuric Acid ⁽¹⁾	52	54	0	5	O	X	O	O	C	-	O	Do not use B3, ML, or ZR when oxidizing impurities such as ferric ions, cupric ions or dissolved oxygen are present.	
Sulfuric Acid ⁽¹⁾	52	54	5	75	C	X	C	O	X	C	C	Do not use B3, ML, or ZR when oxidizing impurities such as ferric ions, cupric ions or dissolved oxygen are present.	
Sulfuric Acid ⁽¹⁾	52	54	75	98	-	-	O	O	X	C	X	Do not use B3, ML, or ZR when oxidizing impurities such as ferric ions, cupric ions or dissolved oxygen are present.	

316 = 316L stainless steel
 304 = 304L stainless steel
 C22 = Nickel alloy C22
 B3 = Nickel alloy B3

TI = Titanium Grade 9
 ML = Alloy 400
 ZR = Zirconium Grade 702

See page 38 for material compatibility codes.

(1) Refer to page 34 for additional information about H₂SO₄.

Material compatibility for fork density meters, viscosity meters

Fluid name	Temp (°C)		Conc. (%wt)		Material compatibility								Notes
	Low	High	Low	High	316	304	C22	B3	TI	ML	ZR		
Sulfuric Acid ⁽¹⁾	54	66	0	5	O	X	O	O	X	-	O	Do not use B3, ML, or ZR when oxidizing impurities such as ferric ions, cupric ions or dissolved oxygen are present.	
Sulfuric Acid ⁽¹⁾	54	66	5	98	C	X	C	C	X	C	C	Do not use B3, ML, or ZR when oxidizing impurities such as ferric ions, cupric ions or dissolved oxygen are present.	
Sulfuric Acid ⁽¹⁾	66	93	0	50	C	X	C	O	X	C	O	Do not use B3, ML, or ZR when oxidizing impurities such as ferric ions, cupric ions or dissolved oxygen are present.	
Sulfuric Acid ⁽¹⁾	66	93	50	98	X	X	C	-	X	C	C	Do not use B3, ML, or ZR when oxidizing impurities such as ferric ions, cupric ions or dissolved oxygen are present.	
Sulfuric Acid ⁽¹⁾	93	204	0	98	X	X	C	C	X	X	C	Do not use B3, ML, or ZR when oxidizing impurities such as ferric ions, cupric ions or dissolved oxygen are present.	
Sulfuric Acid ⁽¹⁾	0	100	99	99	O	O	-	O	X	X	X	Do not use B3, ML, or ZR when oxidizing impurities such as ferric ions, cupric ions or dissolved oxygen are present.	
Sulfuric Acid ⁽¹⁾	0	125	100	100	O	O	C	O	X	X	X	Do not use B3, ML, or ZR when oxidizing impurities such as ferric ions, cupric ions or dissolved oxygen are present.	
Sulfuric Fluoride													
Sulfuryl Chloride								O					
Sulphenilic Acid					O			O					
Sulphurous Acid								O					
Tall Oil Fatty Acid								O					
Tall Oil Rosin								O					
Tall Oil Soap								O					
Tar	150	200			O			O					
Tar Acid	0	200	0	100				O					
Tea					O			O		O			

316 = 316L stainless steel
 304 = 304L stainless steel
 C22 = Nickel alloy C22
 B3 = Nickel alloy B3

TI = Titanium Grade 9
 ML = Alloy 400
 ZR = Zirconium Grade 702

See page 38 for material compatibility codes.

Material compatibility for fork density meters, viscosity meters

Fluid name	Temp (°C)		Conc. (%wt)		Material compatibility							
	Low	High	Low	High	316	304	C22	B3	TI	ML	ZR	Notes
Terephthalic Acid	100	160	0	100	○	○						
Tetrachloroethane	0	70	0	100		○			○			
Tetrachloroethylene Sulfide						○						
Tetrachlorosilane							○					
Tetrafluoroethane					○	○						Dry
Tetrahydrofluorine												
Tetrahydrofuran					○	○						
Tetrasodium EDTA					○	○						
Thinner					○	○			○			
Thiodichloric Acid							○					
Tin Liquor							○					
Titanium Chloride							○		○			
Titanium Dioxide					○	○			○			
Titanium Iron Sulfate Solution												
Titanium Tetrachloride					X	X	○	X	○	X	-	
Toluene					○	○			○			
Toluene Diisocyanate					○	○						
Toluenesulfonic Acid	0	125	0	94			○					
Tomato Paste					○	○						
Triacetin					○	○						
Tribromomethane												
Trichloroacetic Acid	0	120	0	50			○					
Trichloroacetyl Chloride							○					
Trichlorobenzene							○					
Trichlorobromomethane												
Trichloroethane									○			
Trichloroethylene					○	○			○			Dry
Trichloromethylpyridine							○					
Trichloromonofluoroethane					○	○						
Trichlorosilane					○	○						
Trichlorotrifluoroethane					○	○						
Triethanolamine	0	95	0	100	○	○			○			
Triethyl Aluminum					○	○						
Triethylamine					○	○						
Triethylene Glycol					○	○			○			
Trifluoroacetic Acid							○					
Trimethyl Sulfonium Bromide												
Trimethylchlorocyanate							○					
Triphenyl Phosphite					○	○			○			
Trisodiumphosphate	0	200	0	90			○					

316 = 316L stainless steel
 304 = 304L stainless steel
 C22 = Nickel alloy C22
 B3 = Nickel alloy B3

TI = Titanium Grade 9
 ML = Alloy 400
 ZR = Zirconium Grade 702

See page 38 for material compatibility codes.

Synonyms

Material compatibility for fork density meters, viscosity meters

Fluid name	Temp (°C)		Conc. (%wt)		Material compatibility								Notes		
	Low	High	Low	High	316	304	C22	B3	TI	ML	ZR				
Tritylchloride															
Turpentine															
Urea	0	90	0	100					X	O	X	O			
Vanadium Benzene															
Vanadium Chloride															
Vanadium Oxychloride															
Vanadium Oxytrichloride															
Vanadium Tetrachloride															
Vanadium Triacetylacetonate															
Varnish															
Vazo															
Vegetable Tanning Liquor	0	79	0	100											
Vinegar															
Vinyl Acetate															
Vinyl Acetate Polymer Residues															
Vinyl Chloride	0	60	0	100											Latex
Vinyl Chloride	0	65	0	100											Monomer
Vinyl Fluoride															
Vinylidene Chloride															
Vitamin E															
Water	0	200	0	100											Observe chloride limits of Fig 2 for 316L and 304L
Water/Flour/Starch/Corn Syrup															
Wax Emulsion															
Whey/Milk															
Whisky															
White Liquor	20	50	0	100											
Wine															
Xylene	20	120	0	100											

316 = 316L stainless steel
 304 = 304L stainless steel
 C22 = Nickel alloy C22
 B3 = Nickel alloy B3

TI = Titanium Grade 9
 ML = Alloy 400
 ZR = Zirconium Grade 702

See page 38 for material compatibility codes.

Synonyms *continued*

Material compatibility for fork density meters, viscosity meters

Fluid name	Temp (°C)		Conc. (%wt)		Material compatibility							
	Low	High	Low	High	316	304	C22	B3	TI	ML	ZR	Notes
Yeast					○	○						
Yogurt					○	○						
Zeolite							○					
Zinc Carbonate Slurry	0	21	0	100			○					
Zinc Carbonate Slurry	21	82	0	100			○					
Zinc Chloride	0	107	0	71			○		○			
Zinc Dialkyl Dithiophosphate							○					
Zinc Hydrosulfite	0	120	0	10			○					
Zinc Sulfate	0	111	0	34			○		○			
Zirconium Chloride	0	85	0	25			○					
Zirconium Chloride							○					Gas

316 = 316L stainless steel

304 = 304L stainless steel

C22 = Nickel alloy C22

B3 = Nickel alloy B3

TI = Titanium Grade 9

ML = Alloy 400

ZR = Zirconium Grade 702

See page 38 for material compatibility codes.

Synonyms *continued*

Synonym	Listed under	Synonym	Listed under
1, 2 - Benzenedicarboxylic Acid Anhydride	Phthalic Anhydride	C ₃ H ₅ Cl	Allyl Chloride
1, 3 - Phthalandione	Phthalic Anhydride	C ₃ H ₆ O	Allyl Alcohol
1,3 - Dioxophthalan	Phthalic Anhydride	C ₃ H ₆ O	Acetone
2 - Propenoic Acid	Acrylic Acid	C ₄ H ₁₀	Butane
Acetic Aldehyde	Acetaldehyde	C ₄ H ₆ O ₃	Acetic Anhydride
Acetic Ether	Ethyl Acetate	C ₅ Cl ₆	Hexachlorocyclopentadiene
Acetic Oxide	Acetic Anhydride	C ₅ H ₁₁ Cl	Amyl Chloride
Acetyl Oxide	Acetic Anhydride	C ₅ H ₁₂ S	Amyl Mercaptan
Acide Acetique (French)	Acetic Acid	C ₆ H ₁₀ O ₄	Adipic Acid
Acide Sulfurique (French)	Sulfuric Acid	C ₆ H ₆	Benzene
Acido Acetico (Italian)	Acetic Acid	C ₆ H ₇ N	Aniline
Acido Solforico (Italian)	Sulfuric Acid	C ₇ H ₁₆	Heptane
Actylene Tetrachloride	Tetrachloroethane	C ₇ H ₅ ClO	Benzoyl Chloride
Albone	Hydrogen	C ₇ H ₆ O ₂	Benzoic Acid
Aldehyde Acetique (French)	Acetaldehyde	C ₇ H ₇ Cl	Benzyl Chloride
Aldeide Acetica (Italian)	Acetaldehyde	C ₇ H ₈ O	Cresol
Amino Benzene	Aniline	CaCl ₂	Calcium Chloride
Ammonium Hydroxide	Ammonia	CaH ₂ O ₂	Calcium Hydroxide
Anhydride Phtalique (French)	Phthalic Anhydride	Calcium Oxide	Limestone
Anidride Ftalica (Italian)	Phthalic Anhydride	Carbamide	Urea
Ar	Argon	Carbolic Acid	Phenol
AsH ₃ O ₄	Arsenic Acid	Carbon Dichloride	Perchloroethylene
Azijnzuur (Dutch)	Acetic Acid	Carbon Oxychloride	Phosgene
Azine	Pyridine	Carbonyl Chloride	Phosgene
Aziotic Acid	Nitric Acid	Carbonyl Diamide	Urea
Baking Soda	Sodium Bicarbonate	Caustic Potash	Potassium Hydroxide
Battery Acid	Sulfuric Acid	Caustic Soda	Sodium Hydroxide
Benzene Carboxylic Acid	Benzoic Acid	Caustic Sulfite Liquor	Sulfite Liquor
Benzol	Benzene	CCl ₄	Carbon Tetrachloride
BH ₃ O ₃	Boric Acid	CFI ₄	Carbon Tetrafluoride
Br	Bromine	CH ₂ O	Formaldehyde
Bromoform	Tribromomethane	CH ₃ COCH ₃	Acetone
Bromomethane	Methyl Bromide	CH ₃ COOH	Acetic Acid
Butyl Alcohol	Butanol	Chlorallylene	Allyl Chloride
Butylene	Butadiene	Chlorinated cyclic olefin	Hexachlorocyclopentadiene
C ₁₃ H ₁₀ O	Benzophenone	Chlorine Gas	Chlorine
C ₁₄ H ₈ O ₂	Anthraquinone	Chlorine Liquid	Chlorine
C ₂₃ H ₁₇ NO ₃	Atropine	Chlorodiethylacetanilide	Alachlor Technical
C ₂ H ₂	Acetylene	Chloroethylen	Vinyl Chloride
C ₂ H ₃ ClO	Acetyl Chloride	Chloromethane	Methyl Chloride
C ₂ H ₃ N	Acetonitrile	Chloropentane	Amyl Chloride
C ₃ H ₃ N	Acrylonitrile	Chlorotrithloromethyl	Pyridine
C ₃ H ₄ O ₂	Acrylic Acid	Cl ₂	Chlorine
		ClH ₄ N	Ammonium Chloride

Synonym	Listed under
ClO ₂	Chlorine Dioxide
CIP	(Consider each fluid used, or contact Micro Motion)
CNG	Compressed Natural Gas
CO ₂	Carbon Dioxide
Crude Oil	Oil, Crude
CS ₂	Carbon Disulfide
CuCl ₂	Cupric Chloride
Cupric Sulfate	Copper Sulfate
Darammon	Ammonium Chloride
Deac	Diethyl Aluminum Chloride
Deionized Water	Water
Dichloroethane	Ethylene Dichloride
Dichloromethane	Methylene Chloride
Diethyl Ether	Ether
Diethylene Oxide, Tetramethylene Oxide	Tetrahydrofuran
Dihydroxyethane	Ethylene Glycol
Dimethyl Benzene	Xylene
Dimethyl Ketone	Acetone
Dipping Acid	Sulfuric Acid
Dipropyl	Hexane
Dodecyl Bromide	Lauryl Bromide
Dracrylic Acid	Benzoic Acid
Epsom Salt	Magnesium Sulfate
Essigsaeure (German)	Acetic Acid
Ethanoic Acid	Acetic Acid
Ethanoic Acid	Acetic Acid
Ethanal	Acetaldehyde
Ethanol	Ethyl Alcohol
Ethanonitrile	Acetonitrile
Ethenyl Benzene	Styrene
Ethyl Aldehyde	Acetaldehyde
Ethyl Ethanoate	Ethyl Acetate
Ethylene Chloride	Ethylene Dichloride
Ethylic Acid	Acetic Acid
Ethyne	Acetylene
Ethyrene	Butadiene
Formalin	Formaldehyde
Freon 10	Carbon Tetrachloride
Freon 113	Trichlorotrifluoroethane
Freon 12	Dichlorodifluoromethane
Freon 17	Trichloromonofluoroethane
Freon 22	Monochlorodifluoromethane

Synonym	Listed under
Ftaalzuuranhydride (Dutch)	Phthalic Anhydride
Ftalowy Bezwodnik (Polish)	Phthalic Anhydride
Fuel Oil	Oil, Fuel
Fuming Sulfuric Acid	Oleum
Glycol	Ethylene Glycol
H ₃ N	Ammonia
H ₃ N	Ammonia Anhydrous
H ₄ N ₂ O ₃	Ammonium Nitrate
H ₈ N ₂ O ₄ S	Ammonium Sulfate
H ₈ N ₂ S	Ammonium Sulfide
Hartshorn	Ammonium Carbonate
HCl	Hydrochloric Acid
He	Helium
Herbicide	Alachlor Technical
Hexandioic Acid	Adipic Acid
HF	Hydrofluoric Acid
Hg	Mercury
HNO ₃	Nitric Acid
Hydoxy Benzoic Acid	Salicylic Acid
Hydraulic Cylinder Oil	Oil, Hydraulic Cylinder
Hydrochloric Acid/ Nitric Acid (3:1)	Aqua Regia
Hydrogen Peroxide Solution (DOT)	Hydrogen
Hypo Photographic Solution	Sodium Bisulfate
Inhibine	Hydrogen
Isopropanol	Isopropyl Alcohol
JP-4, JP-5	Jet Fuel
KOH	Potassium Hydroxide
Kyanol	Aniline
Li	Lithium
Lime	Limestone
Lime Sulfur	Calcium Sulfide
Liquid Chlorine	Chlorine
LPG	Liquefied Petroleum Gas
Lube Oil	Oil, Lube
Methanal	Formaldehyde
Methanecarboxylic Acid	Acetic Acid
Methanoic Acid	Formic Acid
Methanol	Methyl Alcohol
Methyl Benzene	Toluene
Methyl Cyanide	Acetonitrile
Methyltrichlorosilane	Methyldichlorosilane
Morkit	Anthraquinone

Synonym	Listed under
Muriatic Acid	Hydrochloric Acid
N	Nitrogen
NaCl	Sodium Chloride
NaOH	Sodium Hydroxide
NCI-c56326	Acetaldehyde
Nitrobenzol	Nitrobenzene
Nordhausen Acid (DOT)	Sulfuric Acid
O ₂	Oxygen
Octowy Aldehyd (Polish)	Acetaldehyde
Octowy Kwas (Polish)	Acetic Acid
OH	Alcohols
Oil of Mirbane	Nitrobenzene
Oil of Vitriol	Sulfuric Acid
Opadry	Hydroxypropylmethylcellulose
Oxybisethanol	Diethylene Glycol
Pentanethiol	Amyl Mercaptan
Perchlorocyclopentadiene	Hexachlorocyclopentadiene
Perhydrol	Hydrogen
Perossido di Idrogeno (Italian)	Hydrogen Peroxide
Peroxan	Hydrogen
Peroxide d'Hydrogen (French)	Hydrogen Peroxide
Phenyl Amine	Aniline
Phenyl Chloride	Chlorobenzene
Phenyl Ethylene	Styrene
Phthalic Acid Anhydride	Phthalic Anhydride
Phthalsaeureanhydrid (German)	Phthalic Anhydride
Propanoic Acid	Propionic Acid
Propanol	Propyl Alcohol
Propanone	Acetone
Quartz	Silicon Dioxide
Red Wine	Wine
Saline Solution	Sodium Chloride
Salmiac	Ammonium Chloride
Salt	Sodium Chloride
Salt Brine	Sodium Chloride
Salt Water	Sodium Chloride
Schwefelsaeureloesungen (German)	Sulfuric Acid
Sea Water	Brine
Sib Adduct	Sulfur Monochloride/ Isobutylene
Soda Ash	Sodium Carbonate
Spindle Oil	Oil, Spindle
Sugar of Lead	Lead Acetate

Synonym	Listed under
Sulfurous Acid	Sulphurous Acid
Sulphuric Acid	Sulfuric Acid
Table Salt	Sodium Chloride
Tallow	Animal Fat
Tear Gas	Chloropicrin
Tectilon Blue	Anthraquinone
Tetrachloroethylene	Perchloroethylene
Tetrachloromethane	Carbon Tetrachloride
Tin Dichloride	Stannous Chloride
Tin Tetrachloride	Stannic Chloride
Toluol	Toluene
Transformer Oil	Oil, Transformer
Trichloromethane	Chloroform
Turpentine Oil	Oil, Turpentine
Vinegar Acid	Acetic Acid
Vinyl Benzene	Styrene
Vinyl Cyanide	Acrylonitrile
Vinylformic Acid	Acrylic Acid
Vinyltrichlorosilane	Methyldichlorosilane
Vitriol Brown Oil	Sulfuric Acid
Wasserstoffperoxide (German)	Hydrogen Peroxide
Waste Oil	Oil, Waste
Water Glass	Sodium Silicate
Waterstofperoxyde (Dutch)	Hydrogen Peroxide
White Wine	Wine
Zwavelauroplossingen (Dutch)	Sulfuric Acid

GI-00415, Rev. H

For the latest Micro Motion product specifications, view the PRODUCTS section of our web site at www.micromotion.com

Emerson Process Management Americas

7070 Winchester Circle
Boulder, Colorado USA 80301
www.MicroMotion.com
www.Rosemount.com
I: +1 800 522 6277
T: +1 (303) 527 5200
F: +1 (303) 530 8459

Mexico T: 52 55 5809 5300
Argentina T: 54 11 4837 7000
Brazil T: 55 15 3413 8000
Venezuela T: 58 26 1300 8100

Emerson Process Management Europe/Middle East

Central & Eastern Europe T: +41 41 7686 111
Dubai T: +971 4 811 8100
Abu Dhabi T: +971 2 697 2000
France T: 0800 917 901
Germany T: 0800 182 5347
Italy T: 8008 77334
The Netherlands T: +31 318 495 555
Belgium T: +32 2 716 77 11
Spain T: +34 913 586 000
U.K. T: 0870 240 1978
Russia/CIS T: +7 495 981 9811

Emerson Process Management Asia Pacific

Australia T: (61) 3 9721 0200
China T: (86) 21 2892 9000
India T: (91) 22 6662 0566
Japan T: (81) 3 5769 6803
South Korea T: (82) 2 3438 4600
Singapore T: (65) 6 777 8211

© 2014 Micro Motion, Inc. All rights reserved.

The Emerson logo is a trademark and service mark of Emerson Electric Co. Micro Motion, ELITE, ProLink, MVD and MVD Direct Connect marks are marks of one of the Emerson Process Management family of companies. All other marks are property of their respective owners.

Micro Motion supplies this publication for informational purposes only. While every effort has been made to ensure accuracy, this publication is not intended to make performance claims or process recommendations. Micro Motion does not warrant, guarantee, or assume any legal liability for the accuracy, completeness, timeliness, reliability, or usefulness of any information, product, or process described herein. We reserve the right to modify or improve the designs or specifications of our products at any time without notice. For actual product information and recommendations, please contact your local Micro Motion representative.

