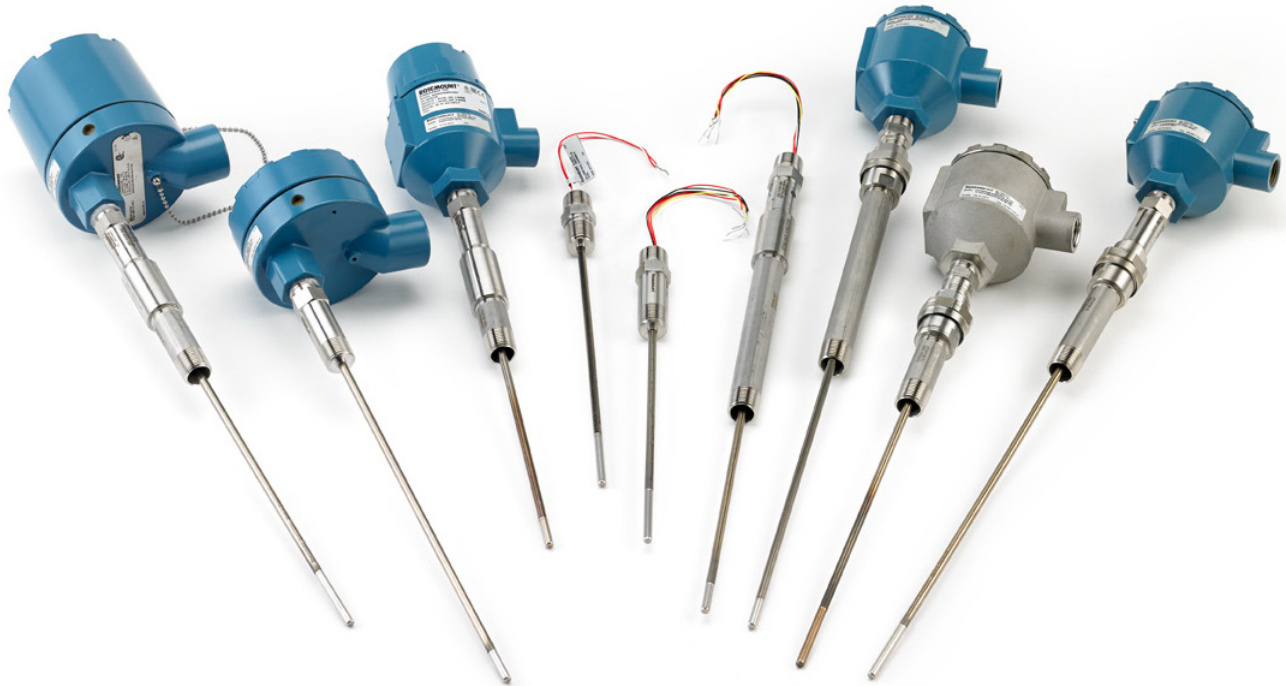


# Rosemount™ 214C Temperature Sensors



## Primary product benefits

- High accuracy resistance temperature detectors (RTD) and various thermocouple types offered in a variety of element configurations
- Calibration capabilities for increased measurement accuracy for RTDs

# Rosemount™ 214C Temperature Sensors

## Optimize plant efficiency and increase measurement reliability with industry-proven design and specifications

- All sensor styles and lengths available as standard in 1/4-in. (6 mm) nominal diameter
- State-of-the-art manufacturing processes providing robust element packaging, increasing reliability
- Industry-leading calibration capabilities allowing for Callendar-Van Dusen values giving increased RTD accuracy when paired with Rosemount transmitters
- Optional Class A accuracy RTDs or Class 1/Special Tolerances thermocouples for critical temperature measurement points

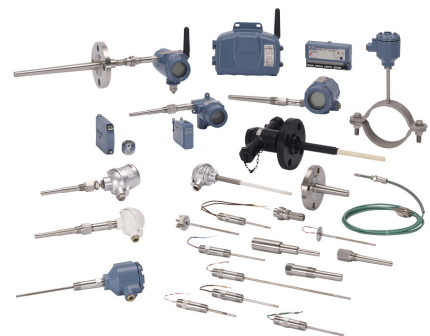
## Explore the benefits of a Complete Point Solution™ from Emerson™

- “Transmitter assembled to sensor” and “Thermowell assembled to sensor” options enable Emerson to provide a complete point temperature solution, delivering process-ready or hand-tight transmitter, sensor, and/or thermowell assemblies
- Complete portfolio of Single Point and Multi-Input Temperature Measurement solutions, allowing effective measurement and processes control with the trusted reliability from Rosemount products



## Experience global consistency and local support from numerous worldwide Emerson manufacturing sites

- World-class manufacturing provides globally consistent product from every factory and the capacity to fulfill needs of any project, large or small
- Experienced Instrumentation Consultants help select the right product for any temperature application and offer advice on best installation practices
- Extensive global network of Emerson service and support personnel can be on-site when and where they are needed



### Contents

Rosemount 214C Sensor . . . . .	3	Product certifications . . . . .	31
RTD ordering information . . . . .	4	Additional RTD specifications . . . . .	46
Thermocouple ordering information . . . . .	12	Additional thermocouple specifications . . . . .	47
Ordering information detail . . . . .	20		

# Rosemount 214C Sensor



The Rosemount 214C Sensors are designed to provide flexible and reliable temperature measurements in process monitoring and control environments.

Features include:

- Temperature ranges of -196 to 600 °C (-321 to 1112 °F) for RTDs and -196 to 1200 °C (-321 to 2192 °F) for thermocouples
- Industry-standard sensor types: PT100 RTDs; thermocouple Type J, Type K, and Type T
- Spring-loaded and compact spring-loaded sensor mounting styles
- Hazardous location product approvals and certification
- Calibration services to give insight to sensor performance
- Calibration certificate to accompany sensor

Specification and selection of product materials, options, or components must be made by the purchaser of the equipment.

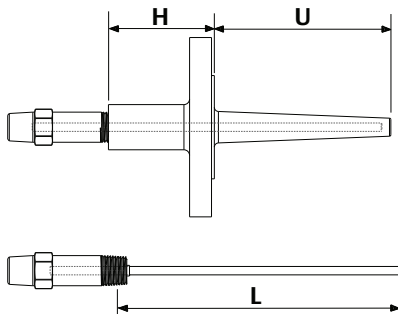
**Figure 1. Model Number Ordering Example**

Model				Sensor type		Sheath material		Sensor accuracy		Number of elements		Units	Sensor insertion length				Sensor mounting style		Options
2	1	4	C	R	W	S	M	A	1	S	4	E	0	1	5	0	S	L	WR5, E5...
1	2	3	4	5	6	7	8	9	10	11	12	13	14	15	16	17	18	19	XXXXX

The numbers below the model string example in [Figure 1](#) correlate to the character place numbers in the ordering table.

## Ensure sensor fits thermowell

Rosemount 114C Head length (H) + Immersion length (U) = Rosemount 214C Sensor insertion length (L).



# RTD ordering information

Table 1. Rosemount 214C RTD Quick Order Table

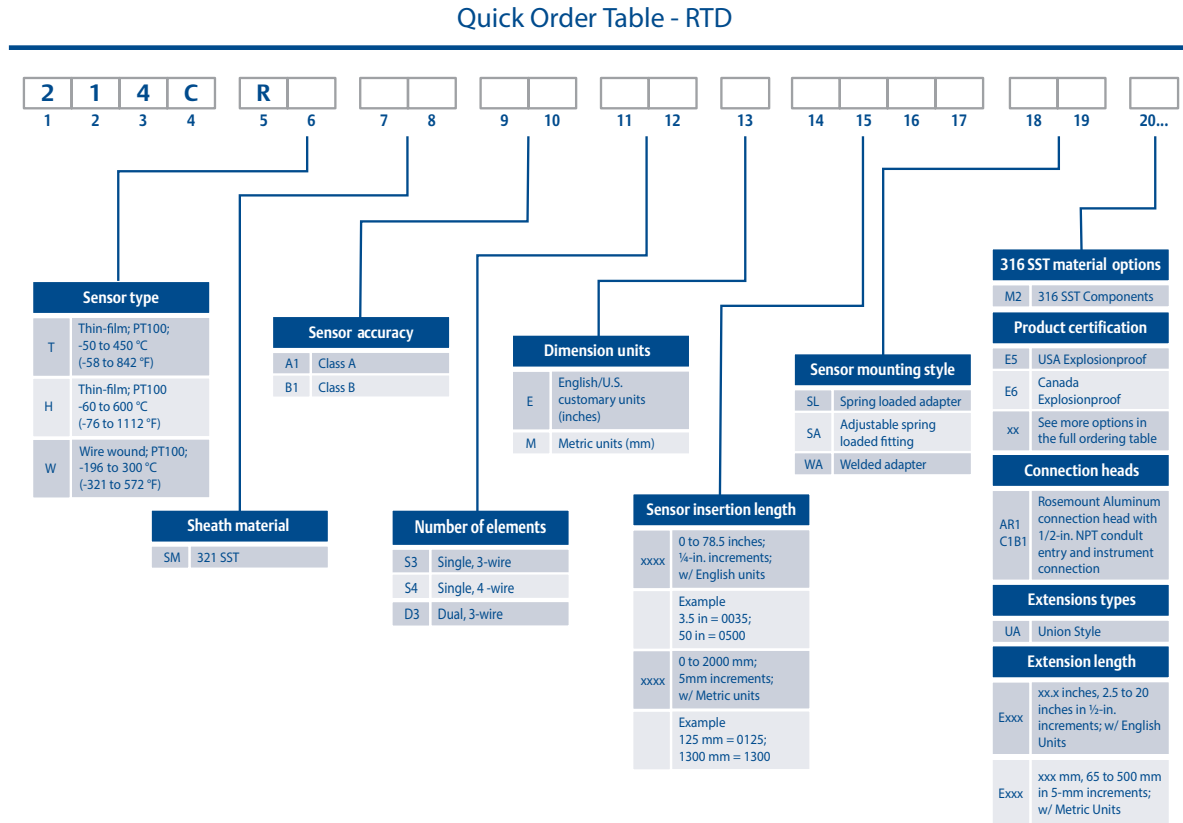


Table 2. Rosemount 214C RTD Ordering Information

The starred offerings (★) represent the most common options and should be selected for best delivery. The non-starred offerings are subject to additional delivery lead time.

Place #s 1-4	Model		
★ 214C	Temperature sensor core base model (made with standard outside diameter of 6 mm [1/4-in.])		
Place #s 5-6	Sensor type	Details	Ref. page
★ RT	RTD, PT100; $\alpha = 0.00385$ ; -50 to 450 °C (-58 to 842 °F)	Thin-film element is better in vibration and physical shock	21
★ RW	RTD, PT100; $\alpha = 0.00385$ ; -196 to 300 °C (-321 to 572 °F)	Wire wound element is better for low temperature applications	21
★ RH	RTD, PT100; $\alpha = 0.00385$ ; -60 to 600 °C (-76 to 1112 °F)	High temperature thin-film element is better in vibration and physical shock	21
Place #s 7-8	Sensor sheath material	Details	
★ SM	321 SST	Maximum operating temperature limit of 816 °C (1500 °F)	23

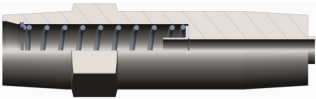
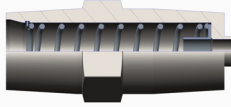
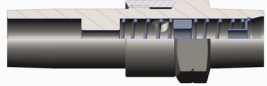
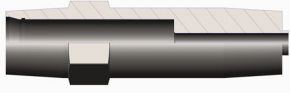
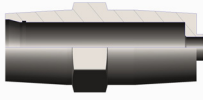
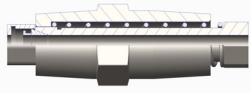
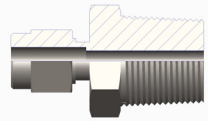

**Table 2. Rosemount 214C RTD Ordering Information**

The starred offerings (★) represent the most common options and should be selected for best delivery. The non-starred offerings are subject to additional delivery lead time.

Place #s 9-10		Sensor accuracy	Details	Image	Ref. page
★	A1	Class A per IEC 60751 over -50 to 300 °C (-58 to 572 °F)	Class A accuracy is only available with wire-wound element Option Code: RW		24
★	B1	Class B per IEC 60751			24
Place #s 11-12		Number of elements	Details	Image	
★	S3	Single, 3-wire	Good measurement results		25
★	S4	Single, 4-wire	Excellent measurement results		25
★	D3	Dual, 3-wire	Added measurement redundancy		25
Place # 13		Dimension units	Details		
★	E	English/U.S. customary units (inches)	Only applies to lengths		26
★	M	Metric units (mm)		26	

**Table 2. Rosemount 214C RTD Ordering Information**


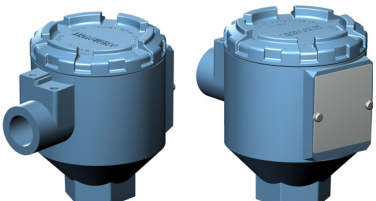
The starred offerings (★) represent the most common options and should be selected for best delivery. The non-starred offerings are subject to additional delivery lead time.

Place #s 14-17		Sensor insertion length (L)		Ref. page	
★	xxxx	xxx.x inches, 0 to 78.5 inches in 1/4-in. increments (when ordered with Dimension units code E) Example of a 6.25-in. length where the second decimal is dropped off: 0062		26	
★	xxxx	xxxx mm, 0 to 2000 mm in 5 mm increments (when ordered with Dimension units code M) Example of a 50 mm length: 0050		26	
Place #s 18-19		Sensor mounting style <sup>(1)</sup>	Details	Image	Ref. page
★	SL	Spring loaded adapter	Ensures sensor contact with thermowell tip		28
★	SC	Compact spring loaded adapter	Non-explosionproof adapter that is 1.17-in. (29.72 mm) shorter than standard spring loaded adapter (currently not available with Division 2/Zone 2 approvals)		28
★	SW	Spring loaded adapter with thermowell contact indication	Spring loaded adapter with a small opening on the side of the adapter for visual indication of sensor contact with the tip of a thermowell		28
★	WA	Welded adapter	Welded joint between sensor capsule and adapter allows for direct immersion of sensor into the process. If thermowell is used, this welded joint acts as a secondary process seal.		29
★	WC	Compact welded adapter	Non-explosionproof adapter that is 1.17-in. (29.72 mm) shorter than standard welded adapter (currently not available with Division 2/Zone 2 approvals)		29
★	SA	Adjustable spring loaded fitting	Adjustable fitting that allows for installation along sensor capsule body. The spring loaded fitting ensures sensor contact to thermowell tip.		29
★	CA	Compression fitting 1/8-in. NPT	Adjustable fitting that allows for installation along the sensor capsule body. (100 psig maximum.) (Default compression fitting material is brass. For stainless steel, select the M2 option.)		29
★	CB	Compression fitting 1/4-in. NPT			
★	CC	Compression fitting 1/2-in. NPT			
★	CD	Compression fitting 3/4-in. NPT			
★	SO	Sensor only	Sensor capsule without any fittings or adapters for mounting		30

**Table 2. Rosemount 214C RTD Ordering Information**

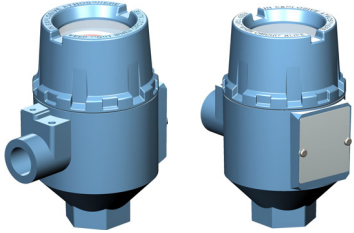
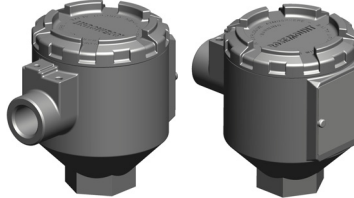
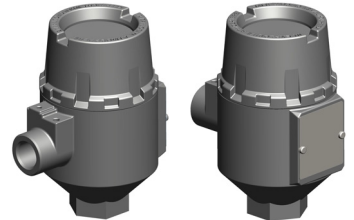
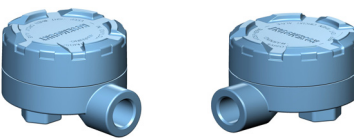
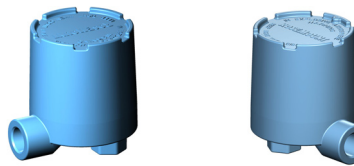
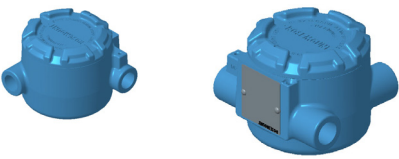
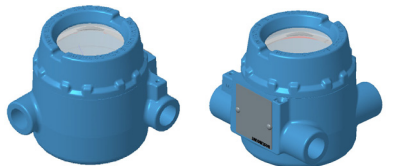
The starred offerings (★) represent the most common options and should be selected for best delivery. The non-starred offerings are subject to additional delivery lead time.

**Options (include with selected model number)**

316SST Material options			Details	Image	Ref. page
★	M1	316SST Wire on tag	Changes out the original 304SST wire on tag to a corrosion-resistant 316SST wire on tag		30
★	M2	316SST Components	Replaces various components with corrosion-resistant 316SST material (review reference page for affected components)		30
Product certifications					Ref. page
★	E1	ATEX Flameproof			31
★	N1	ATEX Zone 2			32
★	ND	ATEX Dust			32
★	E5	USA Explosionproof			31
★	N5	USA Division 2			31
★	E6	Canada Explosionproof			31
★	N6	Canada Division 2			31
★	E7	IECEX Flameproof			33
★	N7	IECEX Zone 2			33
★	NK	IECEX Dust			33
★	KA	Combination of ATEX Flameproof and Canada Explosionproof			35
★	KB	Combination of USA and Canada Explosionproof			35
★	KC	Combination of ATEX Flameproof and USA Explosionproof			35
★	KD	Combination of ATEX Flameproof, USA and Canada Explosionproof			35
★	KE	Combination of ATEX and IECEX Flameproof, USA and Canada Explosionproof			35
★	KN	Combination of ATEX and IECEX Zone 2, USA and Canada Division 2			35
Connection heads			Details	Image	Ref. page
★	AR1	Rosemount aluminum	<ul style="list-style-type: none"> <li>Conduit connection: 1/2-in. NPT; M20</li> <li>Instrument connection: 1/2-in. NPT</li> <li>Optional terminal block, stainless steel cover chain, external ground screw, or low temperature options also available</li> </ul>		36

**Table 2. Rosemount 214C RTD Ordering Information**

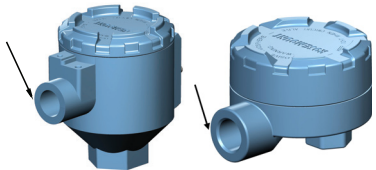
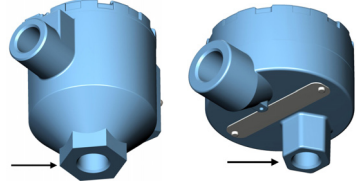


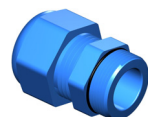


The starred offerings (★) represent the most common options and should be selected for best delivery. The non-starred offerings are subject to additional delivery lead time.

Connection heads			Details	Image	Ref. page
★	AR2	Rosemount aluminum with display cover	<ul style="list-style-type: none"> <li>Conduit connection: 1/2-in. NPT; M20</li> <li>Instrument connection: 1/2-in. NPT</li> <li>Optional terminal block, external ground screw, or low temperature options also available</li> </ul>		36
★	SR1	Rosemount SST	<ul style="list-style-type: none"> <li>Conduit connection: 1/2-in. NPT; M20</li> <li>Instrument connection: 1/2-in. NPT</li> <li>Optional terminal block, stainless steel cover chain, external ground screw, or low temperature options also available</li> </ul>		36
★	SR2	Rosemount SST with display cover	<ul style="list-style-type: none"> <li>Conduit connection: 1/2-in. NPT; M20</li> <li>Instrument connection: 1/2-in. NPT</li> <li>Optional terminal block, external ground screw, or low temperature options also available</li> </ul>		36
★	AT1	Aluminum with terminal strip	<ul style="list-style-type: none"> <li>Conduit connection: 3/4-in. NPT</li> <li>Instrument connection: 1/2-in. NPT</li> <li>Optional stainless steel cover chain or external ground screw available</li> </ul>		36
★	AT3	Aluminum with terminal strip and extended cover	<ul style="list-style-type: none"> <li>Conduit connection: 3/4-in. NPT</li> <li>Instrument connection: 1/2-in. NPT</li> <li>Optional stainless steel cover chain or external ground screw available</li> </ul>		37
★	AJ1	Universal 3 entry aluminum junction box	<ul style="list-style-type: none"> <li>Conduit connection: 1/2-in. NPT or M20</li> <li>Instrument connection 1/2-in. NPT</li> <li>Optional terminal block, external ground screw, and stainless steel cover chain available</li> </ul>		37
★	AJ2	Universal 3 entry aluminum junction box with display cover	<ul style="list-style-type: none"> <li>Conduit connection: 1/2-in. NPT or M20</li> <li>Instrument connection 1/2-in. NPT</li> <li>Optional terminal block, external ground screw, and stainless steel cover chain available</li> </ul>		37



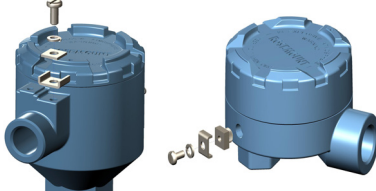
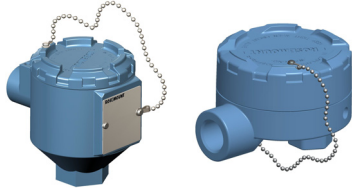
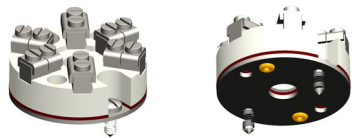
**Table 2. Rosemount 214C RTD Ordering Information**

The starred offerings (★) represent the most common options and should be selected for best delivery. The non-starred offerings are subject to additional delivery lead time.

Conduit entry (selection required for connection heads)				Image	Ref. page
★	C1	1/2-in. NPT	Available for connection head options AR1, AR2, SR1, and SR2		37
★	C2	M20 × 1.5	Available for connection head options AR1, AR2, SR1, and SR2		37
★	C3	3/4-in. NPT	Available for connection head options AT1 and AT3		38
Instrument connection (selection required for connection heads)				Image	Ref. page
★	B1	1/2-in. NPT			38
Conduit cable glands				Image	Ref. page
★	GN1	Ex d, standard cable diameter		39	
★	GN2	Ex d, thin cable diameter		39	
★	GN6	EMV, standard cable diameter			39
★	GP1	Ex e, standard cable diameter, polyamide			39
★	GP2	Ex e, thin cable diameter, polyamide			39
Extension type		Details		Image	Ref. page
★	UA	Union style, 1/2-in. NPT, 1/2-in. NPT	Contains union fitting, which allows orientation of the conduit entry during installation; also known as nipple-union style		39
★	FA	Fixed style, 1/2-in. NPT, 1/2-in. NPT	Contains coupling fitting which does not allow orientation of the conduit entry during installation; also known as nipple-coupling style		39
Extension length (E)					Ref. page
★	Exxx	xx.x inches, 2.5 to 20 inches in 1/2-in. increments (when ordered with Dimension units code E)			40
★	Exxx	xxx mm, 65 to 500 mm in 5 mm increments (when ordered with Dimension units code M)			40

**Table 2. Rosemount 214C RTD Ordering Information**

The starred offerings (★) represent the most common options and should be selected for best delivery. The non-starred offerings are subject to additional delivery lead time.

Single point calibration				Ref. page
★	X91Q4	Resistance of one specified temperature point		42
Temperature range calibration				Ref. page
★	V20Q4	32 to 212 °F (0 to 100 °C)		43
★	V21Q4	32 to 392 °F (0 to 200 °C)		43
★	V22Q4	32 to 842 °F (0 to 450 °C)		43
★	V23Q4	32 to 1112 °F (0 to 600 °C)		43
★	V24Q4	-58 to 212 °F (-50 to 100 °C)		43
★	V25Q4	-58 to 392 °F (-50 to 200 °C)		43
★	V26Q4	-58 to 842 °F (-50 to 450 °C)		43
★	V27Q4	-76 to 1112 °F (-60 to 600 °C)		43
★	X8Q4	Custom specified temperature range		43
Ground screw		Details	Image	Ref. page
★	G1	External ground screw	Allows for grounding of wires to the connection head	 44
Cover chain		Details	Image	Ref. page
★	G3	Cover chain	Keeps the cover connected to the connection head when disassembled; not available with display covers	 44
Terminal block		Details	Image	Ref. page
★	TB	Terminal block	Available if wire termination in a connection head is required	 44
Low temperature housing				Ref. page

**Table 2. Rosemount 214C RTD Ordering Information**

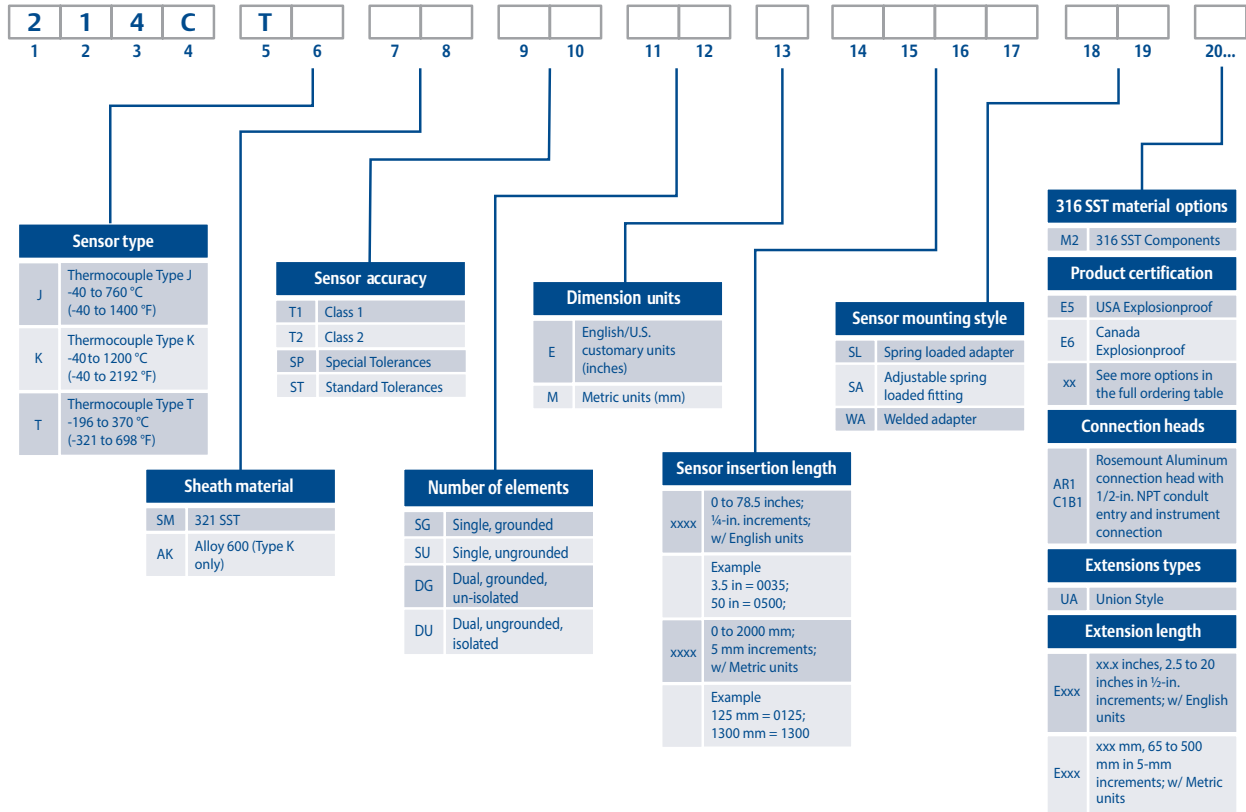
The starred offerings (★) represent the most common options and should be selected for best delivery. The non-starred offerings are subject to additional delivery lead time.

★	LT	Low temperature connection head option down to -51 °C (-60 °F)		44
<b>Transmitter assembled to sensor</b>		<b>Details</b>		<b>Ref. page</b>
★	XA	Process-ready assembly of transmitter and sensor	Ensures sensor is threaded into connection head with transmitter and torqued for process-ready installation; sensor is wired to the transmitter	45
★	XC	Hand-tight assembly of transmitter and sensor	Ensures sensor is threaded into connection head with transmitter but only hand tightened; manual wiring is required	45
<b>Thermowell assembled to sensor</b>		<b>Details</b>		<b>Ref. page</b>
★	XW	Process-ready assembly of sensor and thermowell	Ensures sensor is threaded into thermowell and torqued for process-ready installation	45
★	XT	Hand-tight assembly of sensor and thermowell	Ensures sensor is threaded into thermowell but only hand tightened	45
<b>Extended product warranty</b>		<b>Details</b>		<b>Ref. page</b>
★	WR3	3-year limited warranty	This warranty option is to extend your manufacturers warranty to three or five years for manufacturer related defects	45
★	WR5	5-year limited warranty		45

1. Welded adapters are built several millimeters shorter than specified length to ensure that the sheath will not be damaged by contact with the bottom of a thermowell if overtightened. Conversely, spring loaded adapters are built several millimeters longer than specified to ensure contact with the bottom of a thermowell.

# Thermocouple ordering information

**Table 3. Rosemount 214C Thermocouple Quick Order Table**



**Table 4. Rosemount 214C Thermocouple Ordering Information**

The starred offerings (★) represent the most common options and should be selected for best delivery. The non-starred offerings are subject to additional delivery lead time.

Place #s 1-4	Model		
Place #s 5-6	Sensor type	Details	Ref. page
★ 214C	Temperature thermocouple sensor core base model (made with standard outside diameter of 6mm [1/4-in.])		
★ TJ	Thermocouple Type J, -40 to 760 °C (-40 to 1400 °F)	One of the most common thermocouples made of conductor materials Iron and Constantan	22
★ TK	Thermocouple Type K, -40 to 1200 °C (-40 to 2192 °F)	Commonly used for high temperature applications, Type K thermocouples contain Chromel® and Alumel® conductors (available with sheath material Option AK only)	23
★ TT	Thermocouple Type T, -196 to 370 °C (-321 to 698 °F)	Commonly used for low temperature applications, Type T thermocouples contain copper and constantan conductors	23

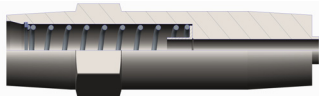
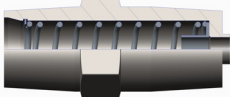
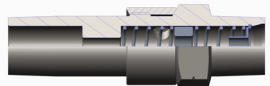
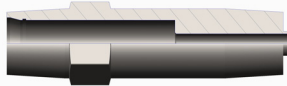
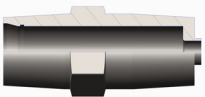
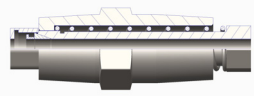
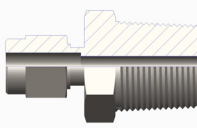

**Table 4. Rosemount 214C Thermocouple Ordering Information**

The starred offerings (★) represent the most common options and should be selected for best delivery. The non-starred offerings are subject to additional delivery lead time.

Place #s 7-8		Sensor sheath material	Details	Ref. page	
★	SM	321 SST	Maximum operating temperature limit of 816 °C (1500 °F) (For types TJ and TT only)	23	
★	AK <sup>(1)</sup>	Alloy 600	Maximum operating temperature limit of 1200 °C (2192 °F) (For type TK only)	24	
Place #s 9-10		Sensor accuracy	Details	Ref. page	
★	T1	Class 1 per IEC 60584	Approximately half of accuracy error margin than Class 2; made with higher grade wire which increases accuracy reading	25	
★	T2	Class 2 per IEC 60584	Wider accuracy error margin than Class 1; made with standard thermocouple grade wire	25	
★	SP	Special Tolerances per ASTM E230	Approximately half of accuracy error margin than Standard Tolerances; made with higher grade wire which increases the accuracy reading	25	
★	ST	Standard Tolerances per ASTM E230	Wider accuracy error margin than Special Tolerances; made with standard thermocouple grade wire	25	
Place #s 11-12		Number of elements	Details	Image	Ref. page
★	SG	Single, grounded	Provides contact to sheath for faster response time than a single, ungrounded thermocouple; more susceptible to induced noise from ground loops		26
★	SU	Single, ungrounded	Provides more accurate reading than a single grounded thermocouple, with a slower response time		26
★	DG	Dual, grounded, unisolated	Provides faster response time than a dual ungrounded isolated thermocouple with added redundancy in the reading		26
★	DU	Dual, ungrounded, isolated	Provides more accurate reading than a dual grounded unisolated thermocouple, with a slower response time		26
Place # 13		Dimension units	Details	Ref. page	
★	E	English/U.S. customary units (inches)	Only applies to lengths	26	
★	M	Metric units (mm)		26	

**Table 4. Rosemount 214C Thermocouple Ordering Information**


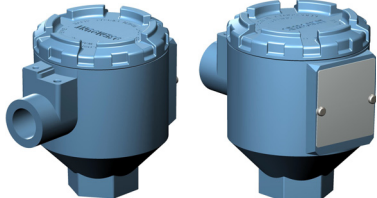
The starred offerings (★) represent the most common options and should be selected for best delivery. The non-starred offerings are subject to additional delivery lead time.

Place #s 14-17		Sensor insertion length (L)		Ref. page	
★	XXXX	xxx.x inches, 0 to 78.5 inches in 1/4-in. increments (when ordered with Dimension units code E) Example of a 6.25-in. length where the second decimal is dropped off: 0062		26	
★	XXXX	xxxx mm, 0 to 2000 mm in 5 mm increments (when ordered with Dimension units code M) Example of a 50 mm length: 0050		26	
Place #s 18-19		Sensor mounting style <sup>(2)</sup>	Details	Image	Ref. page
★	SL	Spring loaded adapter	Ensures sensor contact with thermowell tip		28
★	SC	Compact spring loaded adapter	Non-explosionproof adapter that is 1.17-in. (29.72 mm) shorter than standard spring loaded adapter (currently not available with Division 2/Zone 2 approvals)		28
★	SW	Spring loaded adapter with thermowell contact indication	Spring loaded adapter with a small opening on the side of the adapter for visual indication of sensor contact with the tip of a thermowell		28
★	WA	Welded adapter	Welded joint between sensor capsule and adapter allows for direct immersion of sensor into the process. If thermowell is used, this welded joint acts as a secondary process seal.		29
★	WC	Compact welded adapter	Non-explosionproof adapter that is 1.17-in. (29.72 mm) shorter than standard welded adapter (currently not available with Division 2/Zone 2 approvals)		29
★	SA	Adjustable spring loaded fitting	Adjustable fitting that allows for installation along sensor capsule body. The spring loaded fitting ensures sensor contact to thermowell tip.		29
★	CA	Compression fitting 1/8-in. NPT	Adjustable fitting that allows for installation along the sensor capsule body. (Default compression fitting material is brass. For stainless steel, select the M2 option.) (100 psig maximum.)		29
★	CB	Compression fitting 1/4-in. NPT			
★	CC	Compression fitting 1/2-in. NPT			
★	CD	Compression fitting 3/4-in. NPT			
★	SO	Sensor only	Sensor capsule without any fittings or adapters for mounting		30

**Table 4. Rosemount 214C Thermocouple Ordering Information**

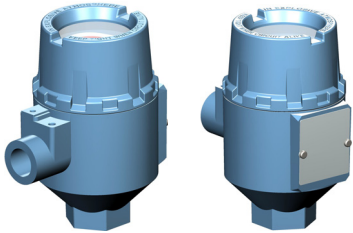
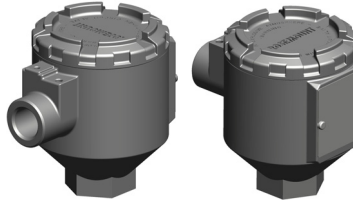
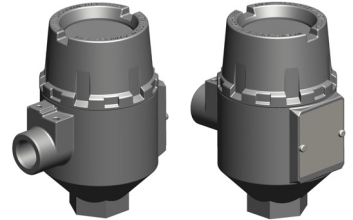
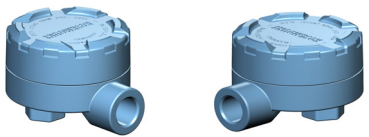
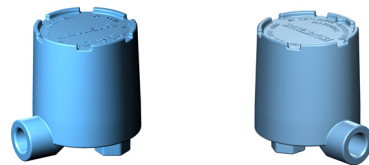
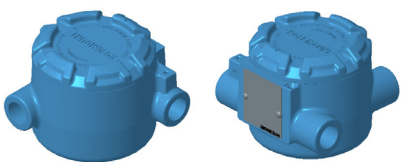
The starred offerings (★) represent the most common options and should be selected for best delivery. The non-starred offerings are subject to additional delivery lead time.

**Options (include with selected model number)**

316SST Material options			Details	Image	Ref. page
★	M1	316SST Wire on tag	Changes out the original 304SST wire on tag to a corrosion-resistant 316SST wire on tag		30
★	M2	316SST Components	Replaces various components with corrosion-resistant 316SST material (review reference page for affected components)		30
Product certifications					Ref. page
★	E1	ATEX Flameproof			31
★	N1	ATEX Zone 2			32
★	ND	ATEX Dust			32
★	E5	USA Explosionproof			31
★	N5	USA Division 2			31
★	E6	Canada Explosionproof			31
★	N6	Canada Division 2			31
★	E7	IECEX Flameproof			33
★	N7	IECEX Zone 2			33
★	NK	IECEX Dust			33
★	KA	Combination of ATEX Flameproof and Canada Explosionproof			35
★	KB	Combination of USA and Canada Explosionproof			35
★	KC	Combination of ATEX Flameproof and USA Explosionproof			35
★	KD	Combination of ATEX Flameproof, USA, and Canada Explosionproof			35
★	KE	Combination of ATEX and IECEX Flameproof, USA, and Canada Explosionproof			35
★	KN	Combination of ATEX and IECEX Zone 2, USA, and Canada Division 2			35
Connection heads			Details	Image	Ref. page
★	AR1	Rosemount aluminum	<ul style="list-style-type: none"> <li>• Conduit connection: 1/2-in. NPT; M20</li> <li>• Instrument connection: 1/2-in. NPT</li> <li>• Optional terminal block, stainless steel cover chain, external ground screw, or low temperature options also available</li> </ul>		36

**Table 4. Rosemount 214C Thermocouple Ordering Information**

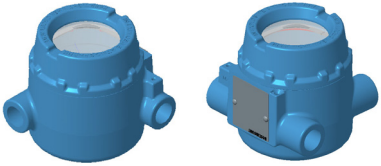
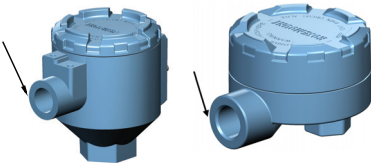
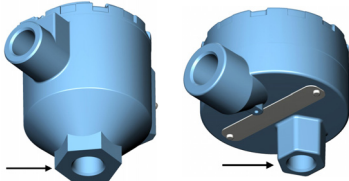


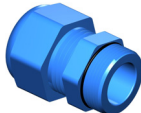
The starred offerings (★) represent the most common options and should be selected for best delivery. The non-starred offerings are subject to additional delivery lead time.

Connection heads			Details	Image	Ref. page
★	AR2	Rosemount aluminum with display cover	<ul style="list-style-type: none"> <li>• Conduit connection: 1/2-in. NPT; M20</li> <li>• Instrument connection: 1/2-in. NPT</li> <li>• Optional terminal block, external ground screw, or low temperature options also available</li> </ul>		36
★	SR1	Rosemount SST	<ul style="list-style-type: none"> <li>• Conduit connection: 1/2-in. NPT; M20</li> <li>• Instrument connection: 1/2-in. NPT</li> <li>• Optional terminal block, stainless steel cover chain, external ground screw, or low temperature options also available</li> </ul>		36
★	SR2	Rosemount SST with display cover	<ul style="list-style-type: none"> <li>• Conduit connection: 1/2-in. NPT; M20</li> <li>• Instrument connection: 1/2-in. NPT</li> <li>• Optional terminal block, external ground screw, or low temperature options also available</li> </ul>		36
★	AT1	Aluminum with terminal strip	<ul style="list-style-type: none"> <li>• Conduit connection: 3/4-in. NPT</li> <li>• Instrument connection: 1/2-in. NPT</li> <li>• Optional stainless steel cover chain or external ground screw available</li> </ul>		36
★	AT3	Aluminum with terminal strip and extended cover	<ul style="list-style-type: none"> <li>• Conduit connection: 3/4-in. NPT</li> <li>• Instrument connection: 1/2-in. NPT</li> <li>• Optional stainless steel cover chain or external ground screw available</li> </ul>		37
★	AJ1	Universal 3 entry aluminum junction box	<ul style="list-style-type: none"> <li>• Conduit connection: 1/2-in. NPT or M20</li> <li>• Instrument connection 1/2-in. NPT</li> <li>• Optional terminal block, external ground screw, and stainless steel cover chain available</li> </ul>		36





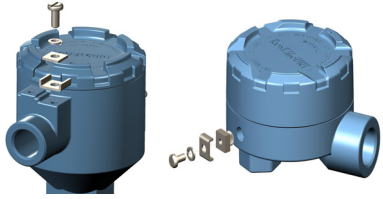
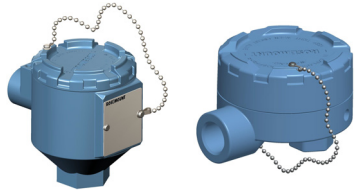
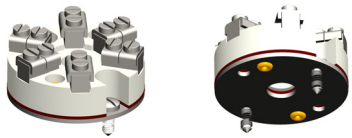
**Table 4. Rosemount 214C Thermocouple Ordering Information**

The starred offerings (★) represent the most common options and should be selected for best delivery. The non-starred offerings are subject to additional delivery lead time.

Connection heads			Details	Image	Ref. page
★	AJ2	Universal 3 entry aluminum junction box with display cover	<ul style="list-style-type: none"> <li>Conduit connection: 1/2-in. NPT or M20</li> <li>Instrument connection 1/2-in. NPT</li> <li>Optional terminal block, external ground screw, and stainless steel cover chain available</li> </ul>		36
Conduit entry (selection required for connection heads)				Image	Ref. page
★	C1	1/2-in. NPT	Available for connection head options AR1, AR2, SR1, and SR2		37
★	C2	M20 × 1.5	Available for connection head options AR1, AR2, SR1, and SR2		37
★	C3	3/4-in. NPT	Available for connection head options AT1 and AT3		38
Instrument connection (selection required for connection heads)				Image	Ref. page
★	B1	1/2-in. NPT			38
Conduit cable glands				Image	Ref. page
★	GN1	Ex d, standard cable diameter			39
★	GN2	Ex d, thin cable diameter			39
★	GN6	EMV, standard cable diameter			39
★	GP1	Ex e, standard cable diameter, polyamide			39
★	GP2	Ex e, thin cable diameter, polyamide			39

**Table 4. Rosemount 214C Thermocouple Ordering Information**

The starred offerings (★) represent the most common options and should be selected for best delivery. The non-starred offerings are subject to additional delivery lead time.

Extension type			Details	Image	Ref. page
★	UA	Union style, 1/2-in. NPT, 1/2-in. NPT	Contains union fitting which allows orientation of the conduit entry during installation; also known as nipple-union style		39
★	FA	Fixed style, 1/2-in. NPT, 1/2-in. NPT	Contains coupling fitting which does not allow orientation of the conduit entry during installation; also known as nipple-coupling style		39
Extension length (E)					Ref. page
★	Exxx	xx.x inches, 2.5 to 20 inches in 1/2-in. increments (when ordered with Dimension units code E)			40
★	Exxx	xxx mm, 65 to 500 mm in 5 mm increments (when ordered with Dimension units code M)			40
Ground screw			Details	Image	Ref. page
★	G1	External ground screw	Allows for grounding of wires to the connection head		44
Cover chain			Details	Image	Ref. page
★	G3	Cover chain	Keeps the cover connected to the connection head when disassembled; not available with display covers		44
Terminal block			Details	Image	Ref. page
★	TB	Terminal block	Available if wire termination in a connection head is required		44
Low temperature housing					Ref. page
★	LT	Low temperature connection head option down to -51 °C (-60 °F)			44
Transmitter assembled to sensor			Details	Image	Ref. page
★	XA	Process-ready assembly of transmitter and sensor	Ensures sensor is threaded into connection head with transmitter and torqued for process-ready installation; sensor is wired to the transmitter		45
★	XC	Hand-tight assembly of transmitter and sensor	Ensures sensor is threaded into connection head with transmitter but only hand tightened; manual wiring is required		45

**Table 4. Rosemount 214C Thermocouple Ordering Information**

The starred offerings (★) represent the most common options and should be selected for best delivery. The non-starred offerings are subject to additional delivery lead time.

Thermowell assembled to sensor			Details	Ref. page
★	XW	Process-ready assembly of sensor and thermowell	Ensures sensor is threaded into thermowell and torqued for process-ready installation	45
★	XT	Hand-tight assembly of sensor and thermowell	Ensures sensor is threaded into thermowell but only hand tightened	45
Extended product warranty			Details	Ref. page
★	WR3	3-year limited warranty	This warranty option is to extend your manufacturers warranty to three or five years for manufacturer related defects	45
★	WR5	5-year limited warranty		45

1. For type TK only.
2. Welded adapters are built several millimeters shorter than specified length to ensure that the sheath will not be damaged by contact with the bottom of a thermowell if overtightened. Conversely, spring loaded adapters are built several millimeters longer than specified to ensure contact with the bottom of a thermowell.

# Ordering information detail

## Sensor type

[Back to RTD ordering table](#)

[Back to Thermocouple ordering table](#)

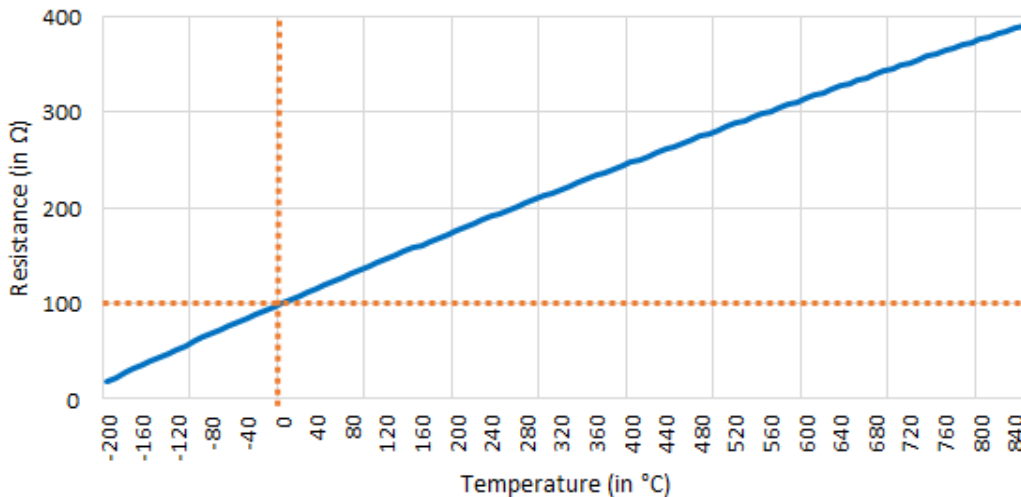
### RTD

RTDs are based on the principle that the electrical resistance of a metal increases as temperature increases – a phenomenon known as thermal resistivity. Thus, a temperature measurement can be inferred by measuring the resistance of the RTD element.

RTDs are constructed of a resistive material with leads attached and usually placed into a protective sheath (see “[Sheath material](#)” on [page 23](#) for details). The resistive material can be a variety of materials. Emerson however, standardizes on platinum materials for all RTDs because of its high accuracy, excellent repeatability, and exceptional linearity over a wide temperature range. Platinum RTDs also exhibit a large resistance change per degree of temperature change.

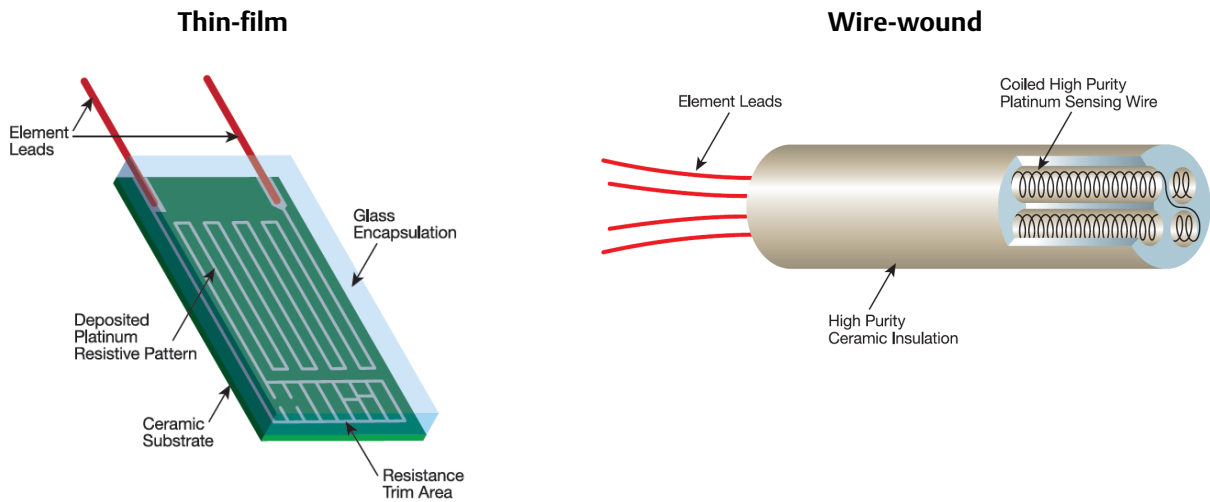
The relationship between the resistance change of an RTD vs. temperature is called its Temperature Coefficient of Resistance (TCR) and is often referred to as the RTD’s alpha curve. Emerson’s PT100 RTDs all have a standard alpha coefficient of  $\alpha = 0.00385$  which is the most popular option that is recognized nationally and internationally. Reference [Figure 2](#) for typical behavior of the resistance of a platinum RTD over a range of temperature.

**Figure 2. Resistance Change vs. Temperature for Platinum RTD (PT100)**



Emerson offers the two most common styles of RTD sensors: thin-film and wire-wound. Wire-wound RTDs are manufactured by winding the resistive wire in a helical shape supported in a ceramic sheath – hence the name wire-wound. Thin-film RTDs are manufactured with a thin resistive coating that is deposited on a flat, usually rectangular ceramic substrate.

Figure 3. RTD Elements



**Thin-film RTD (RT, RH)**

Thin-film elements are generally better in vibration and physical shock. With a platinum construction (PT100) and a temperature coefficient  $\alpha = 0.00385$ , these elements can be rated between  $-60$  to  $600\text{ }^{\circ}\text{C}$  ( $-76$  to  $1112\text{ }^{\circ}\text{F}$ ).

**Wire-wound RTD (RW)**

When a lower temperature range is required for an RTD, the wire-wound element is a better choice. The RW option code is for wire-wound RTDs which are for  $-196$  to  $300\text{ }^{\circ}\text{C}$  ( $-321$  to  $572\text{ }^{\circ}\text{F}$ ). Similar to the thin-film element, this element has a platinum construction (PT100) and an alpha value of  $\alpha = 0.00385$ . Because of its lower temperature range, this option should be chosen for low temperature applications (below  $-60\text{ }^{\circ}\text{C}$  [ $-76\text{ }^{\circ}\text{F}$ ]).

Table 5. RTD Comparison

Option code	RT	RW	RH
Element type	Thin film	Wire wound	High temperature thin film
Temperature range	$-50$ to $450\text{ }^{\circ}\text{C}$ ( $-58$ to $842\text{ }^{\circ}\text{F}$ )	$-196$ to $300\text{ }^{\circ}\text{C}$ ( $-321$ to $572\text{ }^{\circ}\text{F}$ )	$-60$ to $600\text{ }^{\circ}\text{C}$ ( $-76$ to $1112\text{ }^{\circ}\text{F}$ )
Good for	Higher vibration and physical shock	Higher accuracy and low temperature applications	Higher temperature applications, resistance to vibration, and physical shock
Accuracy	Class B	Class A; Class B	Class B

### Thermocouple

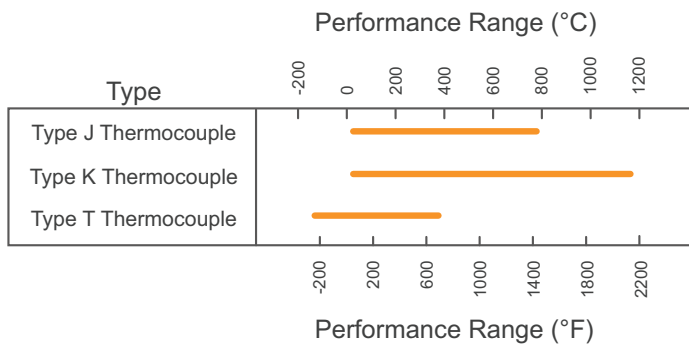
A thermocouple (T/C) is a closed-circuit thermoelectric temperature sensing device consisting of two wires of dissimilar metals joined at both ends. A current is created when the temperature at one end or junction differs from the temperature at the other end. This phenomenon is known as the Seebeck effect, which is the basis for thermocouple temperature measurements.

One end is referred to as the hot junction whereas the other end is referred to as the cold junction. The hot junction measuring element is placed inside a sensor sheath and exposed to the process. The cold junction, or the reference junction, is the termination point outside of the process where the temperature is known and where the voltage is being measured (e.g. in a transmitter, control system input card, or other signal conditioner).

According to the Seebeck effect, a voltage measured at the cold junction is proportional to the difference in temperature between the hot junction and the cold junction. This voltage may be referred to as the Seebeck voltage, thermoelectric voltage, or thermoelectric EMF. As the temperature rises at the hot junction, the observed voltage at the cold junction also increases non-linearly with the rising temperature. The linearity of the temperature-voltage relationship depends on the combination of metals used to make the T/C.

There are many types of T/C that use various metal combinations. These combinations have different output characteristics that define the applicable temperature range it can measure and the corresponding voltage output. The higher the magnitude of the voltage output the higher the measurement resolution, which increases repeatability and accuracy. There are trade-offs between measurement resolutions and temperature ranges which suits individual T/C types to specific ranges and applications. Refer to [Figure 4](#) for different thermocouple behavior over a range of temperatures.

**Figure 4. Thermocouple Temperature Ranges**



Emerson offers a variety of thermocouples: Type J, Type K, and Type T.

### Type J (TJ)

**Figure 5. Type J Thermocouple Colors**



Constructed of iron and constantan, Type J thermocouples have a potential temperature range of -40 to 760 °C (-40 to 1400 °F), and a sensitivity of about 50 μV/°C. Type J thermocouples become brittle below 0 °C (32 °F) and are suitable for use in vacuum, reducing, or inert atmospheres. These thermocouples will have a reduced life if used in an oxidizing atmosphere.

## Type K (TK)

Figure 6. Type K Thermocouple Colors



Constructed of Chromel and Alumel materials, Type K thermocouples are one of the most common general purpose thermocouples, have a potential temperature range of  $-40$  to  $1200\text{ }^{\circ}\text{C}$  ( $-40$  to  $2192\text{ }^{\circ}\text{F}$ ), and a sensitivity of approximately  $41\text{ }\mu\text{V}/^{\circ}\text{C}$ . Type K thermocouples are relatively linear and may be used in continuously oxidizing or neutral atmospheres, and are typically used above  $538\text{ }^{\circ}\text{C}$  ( $1000\text{ }^{\circ}\text{F}$ ).

## Type T (TT)

Figure 7. Type T Thermocouple Colors



Constructed of copper and constantan, Type T thermocouples have a potential temperature range of  $-196$  to  $370\text{ }^{\circ}\text{C}$  ( $-321$  to  $698\text{ }^{\circ}\text{F}$ ) and a sensitivity of  $38\text{ }\mu\text{V}/^{\circ}\text{C}$ . Type T thermocouples demonstrate a good linearity and can be used in oxidizing, reducing or inert atmospheres, as well as in a vacuum. These thermocouples exhibit a high resistance to moisture corrosion, and are typically used in very low (cryogenic) to medium temperature ranges.

Table 6. Thermocouple Types

Option code	TJ	TK	TT
Element type	Type J	Type K	Type T
Metals	Iron-constantan	Chromel-Alumel	Copper-constantan
Temperature range	$-40$ to $760\text{ }^{\circ}\text{C}$ ( $-40$ to $1400\text{ }^{\circ}\text{F}$ )	$-40$ to $1200\text{ }^{\circ}\text{C}$ ( $-40$ to $2192\text{ }^{\circ}\text{F}$ )	$-196$ to $370\text{ }^{\circ}\text{C}$ ( $-321$ to $698\text{ }^{\circ}\text{F}$ )
Good for	Medium temperature ranges	High temperature ranges	Low (cryogenic) temperature ranges

## Sheath material

[Back to RTD ordering table](#)

[Back to Thermocouple ordering table](#)

### (SM)

For Type J and T thermocouples, Emerson offers a protective sheath made of 321 SST. This material is a stainless steel stabilized by adding titanium. This gives it excellent resistance to intergranular corrosion after exposure to high temperatures (above  $427\text{ }^{\circ}\text{C}$  [ $800\text{ }^{\circ}\text{F}$ ]). Type 321 has a maximum operating temperature limit of  $816\text{ }^{\circ}\text{C}$  ( $1500\text{ }^{\circ}\text{F}$ ). The operating temperature range for the sensor element will constrain this limit. See [Table 5](#) and [Table 6](#) for the temperature range of the different sensor element types. This material is only available for Type J and T thermocouple.

**(AK)**

For Type K thermocouples, Emerson offers a protective sheath made of Alloy 600. This material is a nickel-chromium alloy with good oxidation resistance at higher temperatures. Alloy 600 is designed for use in the temperature range of -40 to 1200 °C (-40 to 2192 °F). The operating temperature range for the sensor element will be constrained by this limit. This material is only available for Type K thermocouples.

**Sensor accuracy**

[Back to RTD ordering table](#)  
[Back to Thermocouple ordering table](#)

**(A1, B1)**

The thin-film option codes RT and RH are available in Class B accuracy only.

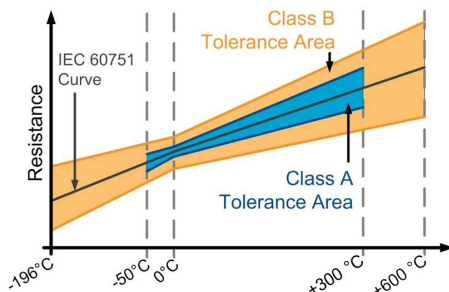
The wire-wound option code RW is intended for applications that require high accuracy and/or subjected to low temperatures. Option code RW is available with both Class A and Class B accuracy over -50 to 300 °C (-58 to 572 °F).

Table 7 shows the interchangeability of RTD sensors. It explains the tolerance for Class A and Class B accuracy RTDs over a specific temperature range. The performance of the option codes RT and RW sensors conform to the standard set by IEC 60751. Figure 8 is a graphical representation that demonstrates the Class A and Class B accuracy curve over temperature per IEC 60751. For maximum system accuracy, Emerson can provide sensor calibration and optional sensor-to-transmitter matching obtainable through the use of Callendar-Van Dusen Constants. See “Calibration” on page 42 for additional calibration offering.

**Table 7. Interchangeability Error for RTD per IEC 60751**

°C (°F)	Tolerance in °C (°F)			
	Class B for RTD Model Option RT	Class B for RTD Model Option RW	Class A for RTD Model Option RW	Class B for RTD Model Option RH
-196 (-321)	N/A	±1.28 (2.30)	N/A	N/A
-100 (-148)	N/A	±0.8 (1.44)	N/A	N/A
-50 (-58)	±0.55 (0.99)	±0.55 (0.99)	±0.25 (0.45)	±0.55 (0.99)
0 (32)	±0.3 (0.54)	±0.3 (0.54)	±0.15 (0.27)	±0.3 (0.54)
100 (212)	±0.8 (1.44)	±0.8 (1.44)	±0.35 (0.63)	±0.8 (1.44)
200 (392)	±1.3 (2.34)	±1.3 (2.34)	±0.55 (0.99)	±1.3 (2.34)
300 (572)	±1.8 (3.24)	±1.8 (3.24)	±0.75 (1.35)	±1.8 (3.24)
450 (842)	±2.55 (4.59)	N/A	N/A	±2.55 (4.59)
500 (932)	N/A	N/A	N/A	±2.8 (5.04)
600 (1112)	N/A	N/A	N/A	±3.3 (5.94)

**Figure 8. Sensor Accuracy Curve**





## (T1, T2, SP, ST)

Similar to RTDs, thermocouples also can have tolerances as defined by national standards. According to IEC 60584, thermocouples can have a narrower tolerance (or higher accuracy) of Class 1. Class 1 thermocouples are manufactured with higher grade wire which increases their accuracy reading. Class 2, on the other hand, has a wider accuracy error margin since they are manufactured with standard thermocouple grade wires.

Emerson also provides thermocouples that meet tolerances per ASTM E230 standards. Special Tolerances are approximately half of accuracy error margin than Standard Tolerances since they are made with higher grade wire.

## Number of elements

[Back to RTD ordering table](#)

[Back to Thermocouple ordering table](#)

### (S3, S4, D3)

For applications where a generic RTD temperature measurement is sufficient, select option S3 for a single, 3-wire measurement. For better results, select option S4 for a single, 4-wire measurement. For added measurement reassurance, select option D3 for a dual, 3-wire measurement.

Since the lead wires are part of the RTD circuit, the lead wire resistance needs to be compensated for to achieve the best accuracy. This becomes especially critical in applications where long sensor and/or lead wires are used. Emerson provides two lead wire configurations that are commonly available: 3-wire and 4-wire.

In a 4-wire configuration, the lead wire resistance is inconsequential to the measurement. It uses a measurement technique where a very small constant current of about 150  $\mu$ A is applied to the sensor through two leads and the voltage developed across the sensor is measured over the other two wires with a high-impedance and high resolution measuring circuit. In accordance with Ohm's Law the high impedance virtually eliminates any current flow in the voltage measurement leads and therefore the resistance of the leads is not a factor.

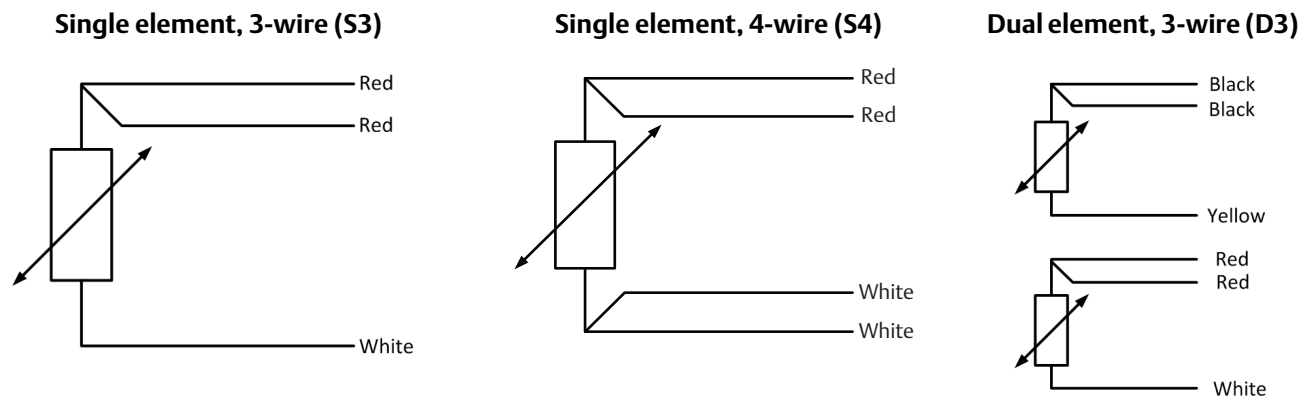
In a 3-wire configuration, compensation is accomplished using a third wire with the assumption that it will be the same resistance as the other two wires and the same compensation is applied to all three wires.

Lead wire configurations can be programmed in Emerson's Rosemount Temperature Transmitters since they are capable of compensating for the various configurations.

All of the available lead wire configurations conform to IEC 60751. As a result, the wire colors for the sensor match what is defined by the standard.

A 4-wire sensor can also be used in a 2- or 3- wire configuration. To properly wire the 4-wire RTD for use in a 2-, 3-, or 4-wire configuration, refer to the Rosemount 214C [Quick Start Guide](#).

**Figure 9. RTD Lead Wire Configurations**

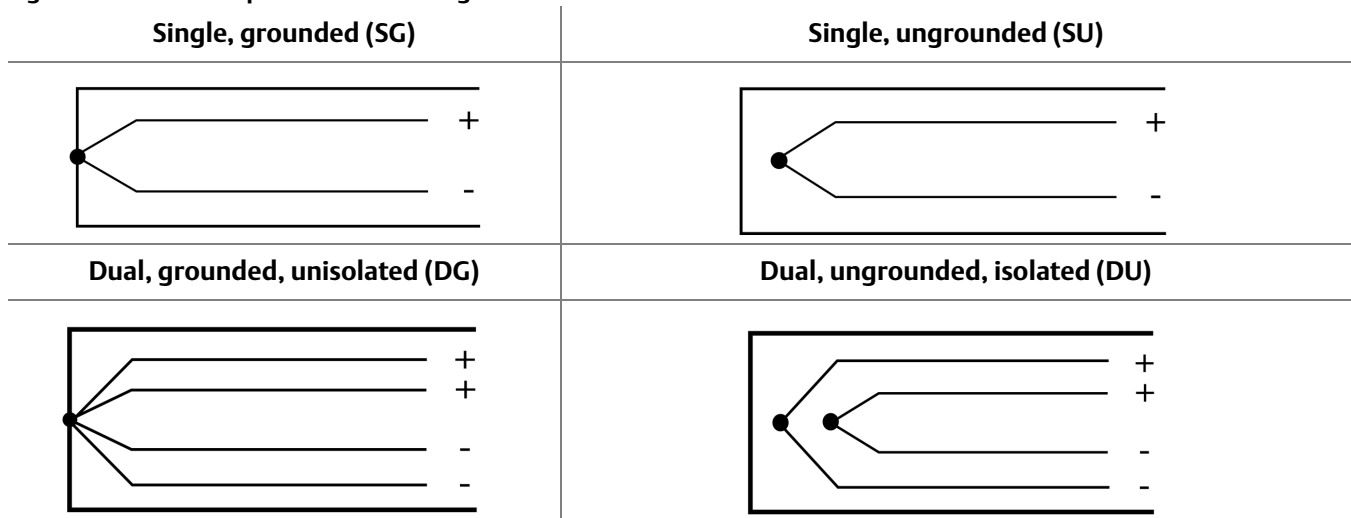


**(SG, SU, DG, DU)**

For generic thermocouple measurements, select option SG for a single, grounded junction thermocouple measurement. This grounded configuration provides contact to the sheath for faster response time; however, this is more susceptible to induced noise from ground loops. This can be avoided by selecting option SU for single, ungrounded thermocouple configuration. This particular type provides a more accurate reading than a single, grounded thermocouple, but with a slower response time due to it's isolation.

For added redundancy in the temperature measurement, select option DG for dual, grounded, unisolated configuration; or option DU for dual, ungrounded, isolated sensor wire configuration. See [Figure 10](#) for all available configurations.

**Figure 10. Thermocouple Lead Wire Configurations**



**Dimension units**

[Back to RTD ordering table](#)

[Back to Thermocouple ordering table](#)

These dimensional units determine both the sensor insertion length and the extension length through the model.

**English/U.S. customary units (E)**

If English/U.S. customary units is selected, then all lengths will be in inches.

**Metric (M)**

If metric is selected, then all lengths will be in millimeters.

**Sensor insertion length**

[Back to RTD ordering table](#)

[Back to Thermocouple ordering table](#)

Sensor insertion length can be ordered by specifying a four-digit option code. However, when ordering, the second decimal place is dropped off.

When ordering in inches, the length can be ordered in 1/4-in. increments. Here are some examples:

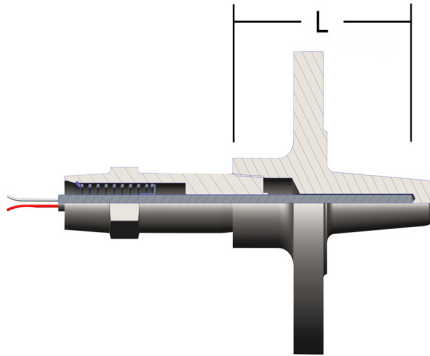
- 120.25-in. = 1202
- 62.75 -in. = 0627

When ordering in millimeters, the length can be ordered in 5 mm increments. Here are some examples:

- 50 mm = 0050
- 325 mm = 0325

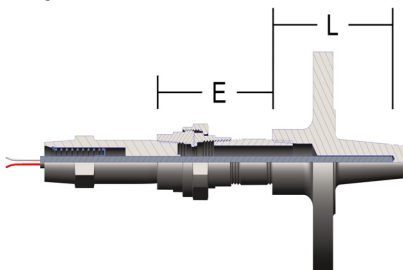
## Determining the length (L) of a replacement spring-loaded sensor in existing installation

### To replace only the sensor



1. Remove the existing sensor from the installation.
2. Measure the sensor length with the spring in the relaxed state from the tip of the sensor to the thread engagement point of 13 mm (0.5-in.) into the adapter threads.
3. Subtract 6 mm (0.25-in.) from your measurement. The resulting length is (L). Use this length to specify the sensor insertion length in the ordering table.

### To replace the sensor and extension



1. Remove the existing sensor and extension from the installed thermowell.
2. Measure the sensor length with the spring in the relaxed state from the tip of the sensor to the thread engagement point of 13 mm (0.5-in.) into the extension threads.
3. Subtract 6 mm (0.25-in.) from your measurement. The resulting length is (L). Use this length to specify the sensor insertion length in the ordering table.
4. Measure the extension length from thermowell connection to the adapter/fitting connection accounting for 13 mm (0.5-in.) thread engagement. The resulting length is (E). Use this length to specify the extension length in the ordering table (see [“Extension length” on page 40](#)).

### Note

Emerson standardizes on a spring compression of 13 mm (0.5-in.) for all spring loaded and compact spring loaded mounting styles for sensors. The thermowell tip thickness is assumed to be 6 mm (0.25-in.) and the sensors are built 6 mm (0.25-in.) longer than the ordered length to ensure contact to the thermowell tip.

To ensure sensor fits the Rosemount 114C Thermowell, refer to [“Ensure sensor fits thermowell” on page 3](#).

## Sensor mounting style

[Back to RTD ordering table](#)

[Back to Thermocouple ordering table](#)

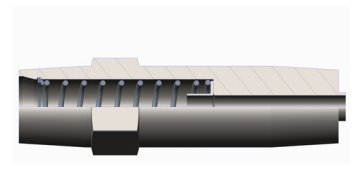
Emerson offers a variety of mounting style options for every sensor. Depending on the application needs and constraints, a certain type of mounting style may be preferred. See description of each style and their dimensions below.

### Threaded style mounting adapters

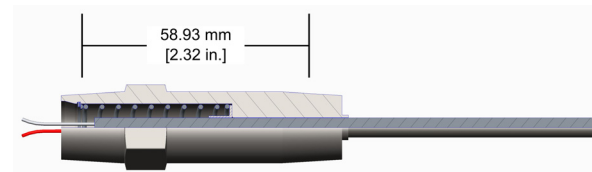
The threaded style is a sensor with a threaded adapter to provide a connection to the process and connection head. The benefit of the threaded style is the ability to install it directly into a process or thermowell without any additional mounting fittings. Emerson currently offers two different threaded mounting styles: Spring loaded adapter and Compact spring loaded adapter.

#### Spring loaded adapter (SL)

A spring located in the threaded adapter allows the sensor to travel, ensuring contact with the bottom of a thermowell. This helps ensure better sensor accuracy, improved sensor response time and aids in providing better performance while under vibration.

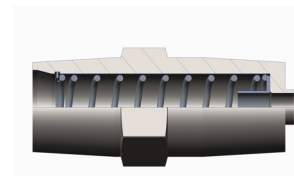


**Figure 11. Dimensions**

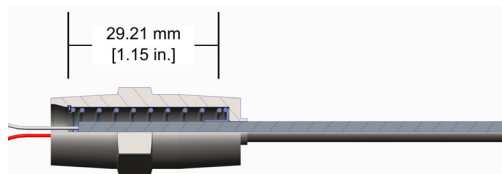


#### Compact spring loaded adapter (SC)

When space is limited, Emerson provides a compact spring loaded adapter. This adapter has a length of 29.21 mm (1.15-in.) as shown in Figure 12. It is also an excellent option for when explosionproof approvals are not a concern yet continuous contact to the thermowell tip is required.

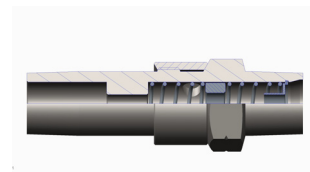


**Figure 12. Dimensions**

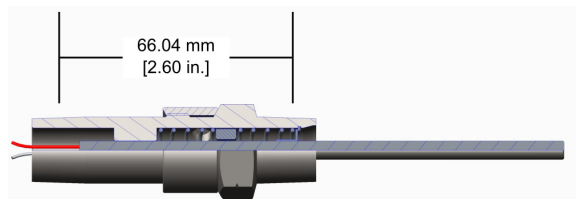


#### Spring loaded adapter with thermowell contact indication (SW)

This spring loaded adapter contains a small opening on the side of the adapter giving this design an added advantage of a visual indication of the sensor contact to the tip of the thermowell. This design is slightly larger with a length of 66.04 mm (2.60-in.).

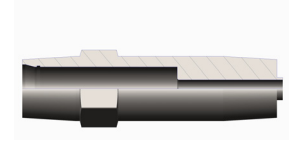


**Figure 13. Dimensions**

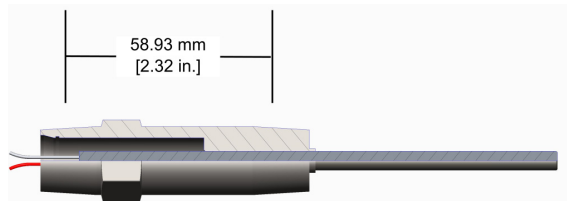


### Welded adapter (WA)

Unlike the spring loaded style, the welded adapter does not contain a spring in the design. Instead, the mounting adapter is welded to the body of the sensor that creates a seal when immersed directly into the process. This seal is rated for 3500 psi.

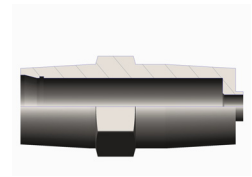


**Figure 14. Dimensions**

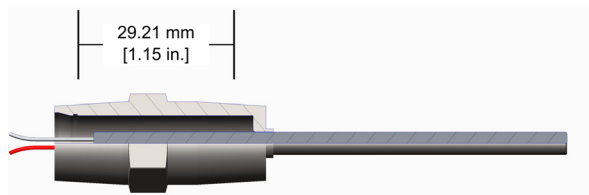


### Compact welded adapter (WC)

Similar size as the compact spring loaded adapter, the compact welded adapter does not contain a spring and the mounting adapter is instead welded to the body of the sensor. This adapter has a length of 29.21 mm (1.15-in.).

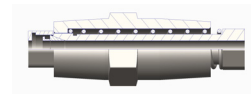


**Figure 15. Dimensions**

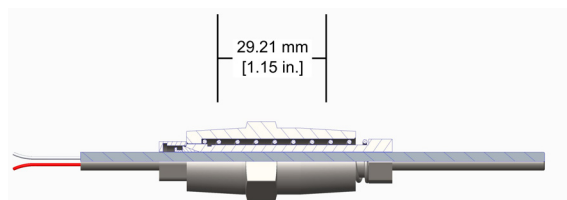


### Adjustable spring loaded fitting (SA)

A spring located in the adjustable threaded compression fitting allows the sensor to travel ensuring contact to the bottom of a thermowell. As a result, this adjustable fitting allows for installation along the body of a sensor capsule that can be of any length.

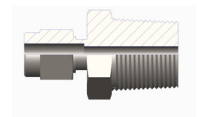


**Figure 16. Dimensions**



### Compression fittings (CA, CB, CC, CD)

An adjustable fitting that allows for installation along the body of a sensor capsule. This limits the need to stock various lengths of sensors. Instead it only requires to insert the sensor in the process or thermowell, adjust the fitting to length and tighten it on to the sensor sheath; allowing for quick set temperature measurement points.



#### Note

Default compression fitting material is brass. For stainless steel, select the M2 option.  
For low pressure applications— 100 psig maximum.

## Sensor only (SO)

Sensor capsule without any fittings or adapters.



## 316SST Material options (M1, M2)

[Back to RTD ordering table](#)

[Back to Thermocouple ordering table](#)

The M1 option changes out the original 304SST wire on tag to a corrosion resistant 316SST wire on tag while the M2 option changes out the following components:

- Wire on tag
- Adapter
- Union
- Nipple
- Name plate
- Drive screws
- Conduit cable glands
- Compression fittings

The components listed above are replaced with corrosion resistant 316SST components.

# Product certifications

[Back to RTD ordering table](#)

[Back to Thermocouple ordering table](#)

Rev 1.17

## European Directive Information

A copy of the EU Declaration of Conformity can be found at the end of the Quick Start Guide. The most recent revision of the EU Declaration of Conformity can be found at [Emerson.com/Rosemount](http://Emerson.com/Rosemount).

## Ordinary Location Certification

The Rosemount 214C has been examined and tested to determine that the design meets the basic electrical, mechanical, and fire protection requirements by a nationally recognized test laboratory (NRTL) as accredited by the Federal Occupational Safety and Health Administration (OSHA).

## North America

The US National Electrical Code® (NEC) and the Canadian Electrical Code (CEC) permit the use of Division marked equipment in Zones and Zone marked equipment in Divisions. The markings must be suitable for the area classification, gas, and temperature class. This information is clearly defined in the respective codes.

- E5** Explosionproof (XP) and Dust-Ignitionproof (DIP)  
 Certificate: 70044744  
 Standards: FM 3600:2011, FM 3615:2006, UL 50E:2007, UL 61010-1:2010, ANSI/ISA 60529:2004  
 Markings: XP CL I, DIV 1, GP B, C, D; DIP CL II, DIV 1, GP E, F, G; CL III; T6 ( $-50\text{ °C} \leq T_a \leq +80\text{ °C}$ ), T5 ( $-50\text{ °C} \leq T_a \leq +95\text{ °C}$ ); Seal not required; installed per Rosemount drawing 00214-1030; Type 4X† and IP 66/67;  $V_{\max}$  35 VDC, 750 mW<sub>max</sub>

### Special Conditions for Safe Use (X):

1. Flameproof joints are not intended for repair.
2. Cable entries must be used which maintain the ingress protection of the enclosure. Unused cable entries must be filled with suitable blanking plugs.

- N5** Division 2 (NI)  
 Certificate: 70044744  
 Standards: FM 3600:2011, FM 3611:2004, UL 50E:2007, UL 61010-1:2010, ANSI/ISA 60529:2004  
 Markings: NI CL I, DIV 2, GP A, B, C, D; T6 ( $-50\text{ °C} \leq T_a \leq +80\text{ °C}$ ), T5 ( $-50\text{ °C} \leq T_a \leq +95\text{ °C}$ ); installed per Rosemount drawing 00214-1030; Type 4X† and IP 66/67;  $V_{\max}$  35VDC, 750 mW<sub>max</sub>

- E6** Explosionproof & Dust-Ignitionproof  
 Certificate: 70044744  
 Standards: CAN/CSA C22.2 No. 0:2010, CAN/CSA No. 25-1966 (R2000), CAN/CSA C22.2 No. 30-M1986 (R2012), CAN/CSA C22.2 No. 94-M1991 (R2011), CAN/CSA C22.2 No. 61010-1:2012  
 Markings: Explosionproof CL I, DIV 1, GP B, C, D; Dust-Ignitionproof CL II, DIV 1, GP E, F, G; CL III; T6 ( $-50\text{ °C} \leq T_a \leq +80\text{ °C}$ ), T5 ( $-50\text{ °C} \leq T_a \leq +95\text{ °C}$ ); Seal not required; installed per Rosemount drawing 00214-1030; Type 4X† and IP 66/67;  $V_{\max}$  35 VDC, 750 mW<sub>max</sub>

### Special Conditions for Safe Use (X):

1. Flameproof joints are not intended for repair.
2. Cable entries must be used which maintain the ingress protection of the enclosure. Unused cable entries must be filled with suitable blanking plugs.

- N6** Division 2  
 Certificate: 70044744  
 Standards: : CAN/CSA C22.2 No. 0:2010, CAN/CSA C22.2 No. 94-M1991 (R2011), CAN/CSA No. 213-M1987 (R2013), CAN/CSA C22.2 No. 61010-1:2012  
 Markings: CL I, DIV 2, GP A, B, C, D; T6 ( $-50\text{ °C} \leq T_a \leq +80\text{ °C}$ ), T5 ( $-50\text{ °C} \leq T_a \leq +95\text{ °C}$ ); Seal not required; installed per Rosemount drawing 00214-1030; Type 4X† and IP 66/67;  $V_{\max}$  35 VDC, 750 mW<sub>max</sub>

† – Spring loaded indicator has reduced ingress and dust ratings. Spring loaded sensors must be installed in a thermowell to maintain dust and ingress ratings. Unpainted aluminum enclosures are Type 4 rated.

## Europe

- E1** Flameproof  
 Certificate: DEMKO 16 ATEX 1677X  
 Standards: EN 60079-0:2012+A11 2013, EN 60079-1:2014  
 Markings: **CE** 1180 **Ex** II 2 G Ex db IIC T6...T1 Gb T6 ( $-50\text{ °C} \leq T_a \leq +80\text{ °C}$ ), T5 ( $-50\text{ °C} \leq T_a \leq +95\text{ °C}$ ), T4...T1 ( $-50\text{ °C} \leq T_a \leq +100\text{ °C}$ )  $V_{\max}$  = 45 Vdc,  $P_{\max}$  = 750 mW


**Installation Instructions:**

1. Use field wiring suitable for both the minimum and maximum service temperatures.
2. These devices are provided without cable glands/conduit sealing devices/blanking elements. Proper selection of suitable cable glands/conduit sealing/blanking elements should occur in the field.
3. Unused apertures shall be closed with suitable blanking elements.
4. The enclosures may be provided with up to (3) 1/2-in.–14 NPT, 3/4-in.–14 NPT, or M20 × 1.5 entries, with location of the entries specified in the installation instructions document.

**Special Conditions for Safe Use (X):**

1. Refer to certificate for details regarding process and ambient temperature limits.
2. When the 214C sensor is provided with an enclosure with a display cover, the maximum ambient shall be 95 °C.
3. The non-metallic label on the device may store an electrostatic charge and become a source of ignition in Group III atmospheres. Care shall be taken to reduce electrostatic build-up. For example, the non-metallic label may be rubbed with a damp cloth.
4. The display covers were impacted at 4J according to a low risk of mechanical danger. Guard the display covers against impact energies greater than 4J.
5. Flameproof joints are not intended for repair.
6. The stand-alone 214C sensors without an enclosure must be assembled to a suitable Ex certified enclosure of a volume no greater than 0.55 L to maintain the types of protection “db” and “tb”.
7. The spring loaded sensors and DIN sensors must be installed in a thermowell to maintain IP6X ratings.
8. Contact indicating sensors do not meet requirements for protection type “tb” and therefore are not “tb” rated.

**I1 ATEX Intrinsic Safety**


Certificate: Baseefa16ATEX0101X  
 Standards: EN 60079-0:2012+A11:2013,  
 EN 60079-11:2012  
 Markings:  II 1 G Ex ia IIC T5/T6 Ga  
 (See certificate for schedule)

Thermocouples; Pi = 500 mW	T6 60 °C ≤ T <sub>a</sub> ≤ +70 °C
RTDs; Pi = 192 mW	T6 60 °C ≤ T <sub>a</sub> ≤ +70 °C
RTDs; Pi = 290 mW	T6 60 °C ≤ T <sub>a</sub> ≤ +60 °C T5 60 °C ≤ T <sub>a</sub> ≤ +70 °C



**Special Condition for Safe Use (X):**

1. The equipment must be installed in an enclosure which affords it a degree of ingress protection of at least IP20.

**N1 ATEX Type n—with enclosure**

Certificate: BAS00ATEX3145  
 Standards: EN 60079-0:2012, EN 60079-15:2010  
 Markings:  II 3 G Ex nA IIC T5 Gc (–40 °C ≤ T<sub>a</sub> ≤ +70 °C)

**ND Dust**

Certificate: DEMKO 16 ATEX 1677X  
 Standards: EN 60079-0:2012+A11 2013, EN 60079-1:2014  
 Markings:  1180  II 2 D Ex tb IIIC T130 °C Db (–50 °C ≤ T<sub>a</sub> ≤ +100 °C) V<sub>max</sub>=45 Vdc, P<sub>max</sub>=750 mW

**Installation Instructions:**

1. Use field wiring suitable for both the minimum and maximum service temperatures.
2. These devices are provided without cable glands/conduit sealing devices/blanking elements. Proper selection of suitable cable glands/conduit sealing/blanking elements should occur in the field.
3. Unused apertures shall be closed with suitable blanking elements.
4. The enclosures may be provided with up to (3) 1/2-in.–14 NPT, 3/4-in.–14 NPT, or M20 × 1.5 entries, with location of the entries specified in the installation instructions document.

**Special Conditions for Safe Use (X):**

1. Refer to certificate for details regarding process and ambient temperature limits.
2. When the 214C sensor is provided with an enclosure with a display cover, the maximum ambient shall be 95 °C.
3. The non-metallic label on the device may store an electrostatic charge and become a source of ignition in Group III atmospheres. Care shall be taken to reduce electrostatic build-up. For example, the non-metallic label may be rubbed with a damp cloth.
4. The display covers were impacted at 4J according to a low risk of mechanical danger. Guard the display covers against impact energies greater than 4J.
5. Flameproof joints are not intended for repair.
6. The stand-alone 214C sensors without an enclosure must be assembled to a suitable Ex certified enclosure of a volume no greater than 0.55 L to maintain the types of protection “db” and “tb”.
7. The spring loaded sensors and DIN sensors must be installed in a thermowell to maintain IP6X ratings.
8. Contact indicating sensors do not meet requirements for protection type “tb” and therefore are not “tb” rated.



## International

### E7 Flameproof

Certificate: IECEx UL 16.0048X

Standards: IEC 60079-0:2011, IEC 60079-1:2014

Markings: Ex db IIC T6...T1 Gb T6(-50 °C ≤ T<sub>a</sub> ≤ +80 °C),  
T5(-50 °C ≤ T<sub>a</sub> ≤ +95 °C), T4...T1(-50 °C ≤ T<sub>a</sub> ≤  
+100 °C) V<sub>max</sub> = 45 Vdc, P<sub>max</sub> = 750 mW

#### Installation Instructions:

1. Use field wiring suitable for both the minimum and maximum service temperatures.
2. These devices are provided without cable glands/conduit sealing devices/blanking elements. Proper selection of suitable cable glands/conduit sealing/blanking elements should occur in the field.
3. Unused apertures shall be closed with suitable blanking elements.
4. The enclosures may be provided with up to (3) 1/2-in.-14 NPT, 3/4-in.-14 NPT, or M20 × 1.5 entries, with location of the entries specified in the installation instructions document.

#### Special Conditions for Safe Use (X):

1. Refer to certificate for details regarding process and ambient temperature limits.
2. When the 214C sensor is provided with an enclosure with a display cover, the maximum ambient shall be 95 °C.
3. The non-metallic label on the device may store an electrostatic charge and become a source of ignition in Group III atmospheres. Care shall be taken to reduce electrostatic build-up. For example, the non-metallic label may be rubbed with a damp cloth.
4. The display covers were impacted at 4J according to a low risk of mechanical danger. Guard the display covers against impact energies greater than 4J.
5. Flameproof joints are not intended for repair.
6. The stand-alone 214C sensors without an enclosure must be assembled to a suitable Ex certified enclosure of a volume no greater than 0.55 L to maintain the types of protection “db” and “tb”.
7. The spring loaded sensors and DIN sensors must be installed in a thermowell to maintain IP6X ratings.
8. Contact indicating sensors do not meet requirements for protection type “tb” and therefore are not “tb” rated.

### I7 IECEx Intrinsic Safety

Certificate: IECEx BAS 16.0077X

Standards: IEC 60079-0: 2011, IEC 60079-11:2011

Markings: Ex ia IIC T5/T6 Ga

(See certificate for schedule)

Thermocouples; P <sub>i</sub> = 500 mW	T6 60 °C ≤ T <sub>a</sub> ≤ +70 °C
RTDs; P <sub>i</sub> = 192 mW	T6 60 °C ≤ T <sub>a</sub> ≤ +70 °C
RTDs; P <sub>i</sub> = 290 mW	T6 60 °C ≤ T <sub>a</sub> ≤ +70 °C T5 60 °C ≤ T <sub>a</sub> ≤ +70 °C

#### Special Condition for Safe Use (X):

1. Use field wiring suitable for both the minimum and maximum service temperatures.

### N7 IECEx Type n—with enclosure

Certificate: IECEx BAS 07.0055

Standards: IEC 60079-0:2011, IEC 60079-15:2010

Markings: Ex nA IIC T5 Gc; T5(-40 °C ≤ T<sub>a</sub> ≤ +70 °C)

### NK Dust

Certificate: IECEx UL 16.0048X

Standards: IEC 60079-0:2011, IEC 60079-31:2013

Markings: Ex tb IIIC T130 °C Db (-50 °C ≤ T<sub>a</sub> ≤ +100 °C)  
V<sub>max</sub> = 45 Vdc, P<sub>max</sub> = 750 mW

#### Installation Instructions:

1. Use field wiring suitable for both the minimum and maximum service temperatures.
2. These devices are provided without cable glands/conduit sealing devices/blanking elements. Proper selection of suitable cable glands/conduit sealing/blanking elements should occur in the field.
3. Unused apertures shall be closed with suitable blanking elements.
4. The enclosures may be provided with up to (3) 1/2-in.-14 NPT, 3/4-in.-14 NPT, or M20 × 1.5 entries, with location of the entries specified in the installation instructions document.

#### Special Conditions for Safe Use (X):

1. Refer to certificate for details regarding process and ambient temperature limits.
2. When the 214C sensor is provided with an enclosure with a display cover, the maximum ambient shall be 95 °C.
3. The non-metallic label on the device may store an electrostatic charge and become a source of ignition in Group III atmospheres. Care shall be taken to reduce electrostatic build-up. For example, the non-metallic label may be rubbed with a damp cloth.
4. The display covers were impacted at 4J according to a low risk of mechanical danger. Guard the display covers against impact energies greater than 4J.
5. Flameproof joints are not intended for repair.
6. The stand-alone 214C sensors without an enclosure must be assembled to a suitable Ex certified enclosure of a volume no greater than 0.55 L to maintain the types of protection “db” and “tb”.
7. The spring loaded sensors and DIN sensors must be installed in a thermowell to maintain IP6X ratings.

- Contact indicating sensors do not meet requirements for protection type "tb" and therefore are not "tb" rated.

## Brazil

- E2** Flameproof & Dust-Ignitionproof  
 Certificate: UL-BR 17.0199X  
 Standards: ABNT NBR IEC 60079-0:2013, ABNT NBR IEC 60079-1:2016, ABNT NBR IEC 60079-31:2014  
 Markings: Ex db IIC T6...T1 Gb T6(-50 °C ≤ T<sub>a</sub> ≤ +80 °C), T5(-50 °C ≤ T<sub>a</sub> ≤ +95 °C), T4...T1(-50 °C ≤ T<sub>a</sub> ≤ +100 °C), Ex tb IIIC T130 °C (-50 °C ≤ T<sub>a</sub> ≤ +100 °C)

### Special Conditions for Safe Use (X):

- Refer to certificate for details regarding process and ambient temperature limits.
- When the Rosemount 214C sensor is provided with an enclosure with a display cover, the maximum ambient shall be 95 °C.
- The non-metallic label on the device may store an electrostatic charge and become a source of ignition in Group III atmospheres. Care shall be taken to reduce electrostatic build-up. For example, the non-metallic label may be rubbed with a damp cloth.
- The display covers were impacted at 4J according to a low risk of mechanical danger. Guard the display covers against impact energies greater than 4J.
- Flameproof joints are not intended for repair.
- The stand-alone 214C sensors without an enclosure must be assembled to a suitable Ex certified enclosure of a volume no greater than 0.55 L to maintain the types of protection "db" and "tb".
- The spring loaded sensors and DIN sensors must be installed in a thermowell to maintain IP6X ratings.
- Contact indicating sensors do not meet requirements for protection type "Ex tb" and therefore are not "Ex tb" rated on this certificate.

- I2** Intrinsic Safety  
 Certificate: UL-BR 18.0257X  
 Standards: ABNT NBR IEC 60079-0:2013, ABNT NBR IEC 60079-11:2013  
 Markings: Ex ia IIC T6...T5 Ga  
 Thermocouples: P<sub>i</sub> = 500 mW, T6(-60 °C ≤ T<sub>a</sub> ≤ +70 °C)  
 RTDs: P<sub>i</sub> = 192 mW, T6(-60 °C ≤ T<sub>a</sub> ≤ +70 °C)  
 P<sub>i</sub> = 290 mW, T6(-60 °C ≤ T<sub>a</sub> ≤ +60 °C),  
 T5(-60 °C ≤ T<sub>a</sub> ≤ +70 °C)

### Special Condition for Safe Use (X):

- The equipment must be installed in an enclosure which affords it a degree of ingress protection of at least IP20.

## China

- E3** Flameproof & Dust-Ignitionproof  
 Certificate: GYJ17.1010X  
 Standards: GB 3836.1-2010, GB 3836.2-2010, GB 12476.1-2013, GB 12476.5-2013  
 Markings: Ex d IIC T6~T1 Gb, Ex td A21 IP6X T130 °C

### Special Condition for Safe Use (X):

- Refer to certificate for details regarding process and ambient temperature limits as well as Special Conditions for Safe Use.

- I3** Intrinsic Safety  
 Certificate: GYJ18.1024X  
 Standards: GB 3836.1-2010, GB 3836.4-2010, GB 3836.20-2010  
 Markings: Ex ia IIC T5/T6 Ga

### Special Condition for Safe Use (X):

- Refer to certificate for details regarding process and ambient temperature limits as well as Special Conditions for Safe Use.

- N3** Zone 2  
 Certificate: GYJ18.1025  
 Standards: GB 3836.1-2010, GB 3836.8-2014  
 Markings: Ex nA IIC T5 Gc, T5(-40 °C ≤ T<sub>a</sub> ≤ +70 °C)

### Special Condition for Safe Use (X):

- Refer to certificate for details regarding process and ambient temperature limits as well as Special Conditions for Safe Use.

## Korea

- EP** Flameproof & Dust-Ignitionproof  
 Certificate: 17-KA4BO-0305X  
 Markings: Ex d IIC T6...T1, T6(-50 °C ≤ T<sub>a</sub> ≤ +80 °C), T5(-50 °C ≤ T<sub>a</sub> ≤ +95 °C), T4...T1(-50 °C ≤ T<sub>a</sub> ≤ +100 °C)

- Certificate: 17-KA4BO-0306X  
 Markings: Ex tb IIIC T130°C, T130°C(-50 °C ≤ T<sub>a</sub> ≤ +100 °C)

### Special Condition for Safe Use (X):

- Refer to certificate for Special Conditions for Safe Use.

- IP** Intrinsic Safety  
 Certificate: 17-KA4BO-0304X  
 Markings: Ex ia IIC T6/T5

### Special Condition for Safe Use (X):

- Refer to certificate for details regarding process and ambient temperature limits as well as Special Conditions for Safe Use.

**N3** Zone 2  
 Certificate: GYJ18.1025  
 Standards: GB 3836.1-2010, GB 3836.8-2014  
 Markings: Ex nA IIC T5 Gc, T5(-40 °C ≤ T<sub>a</sub> ≤ +70 °C)

**Special Condition for Safe Use (X):**

1. Refer to certificate for details regarding process and ambient temperature limits as well as Special Conditions for Safe Use.

## Russia

**EM** Flameproof  
 Certificate: GYJ17.1010X  
 Markings: 1Ex db IIC T6...T1 Gb X, T6(-50 °C ≤ T<sub>a</sub> ≤ +80 °C), T5(-50 °C ≤ T<sub>a</sub> ≤ +95 °C), T4...T1 (-50 °C ≤ T<sub>a</sub> ≤ +100 °C)

**Special Condition for Safe Use (X):**

1. Refer to certificate for Special Conditions for Safe Use.

**IM** Intrinsic Safety  
 Certificate: GYJ18.1024X  
 Markings: 0Ex ia IIC T5, T6 Ga X

**Special Condition for Safe Use (X):**

1. Refer to certificate for details regarding process and ambient temperature limits as well as Special Conditions for Safe Use.

**KM** EAC Flameproof, Dust-Ignitionproof, and Intrinsic Safety  
 Certificate: GYJ18.1025  
 Markings: Ex tb IIIC T130 °C Db X in addition to the markings above for EM and IM.

**Special Condition for Safe Use (X):**

1. Refer to certificate for details regarding process and ambient temperature limits as well as Special Conditions for Safe Use.

## Combinations

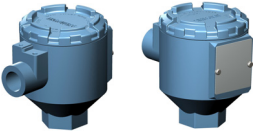
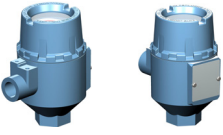

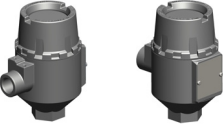
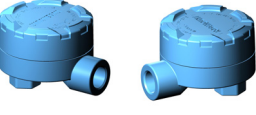
**K1** Combination of E1, I1, and N1  
**KA** Combination of E3, I3, and N3  
**KA** Combination of E7, I7, and N7  
**KA** Combination of E1 and E6  
**KB** Combination of E5 and E6  
**KC** Combination of E1 and E5  
**KD** Combination of E1, E5, and E6  
**KM** Combination of EM and IM  
**KN** Combination of N1, N5, N6, and N7  
**KP** Combination of EP and IP

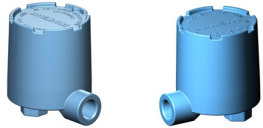
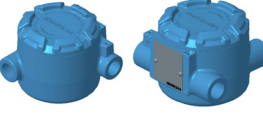
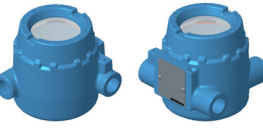
## Connection heads

[Back to RTD ordering table](#)

[Back to Thermocouple ordering table](#)

The connection heads provide high-level durability and mechanical protection for harsh environments. All connection heads are rated IP66/68 and NEMA® 4X.

Head description (code)	Corrosion resistance	Explosionproof design	Conduit options <sup>(1)</sup>	Conduit entries	Instrument connection <sup>(1)</sup>	Features	Recommendations
<b>Rosemount aluminum (AR1)</b> 	★★☆☆	Yes	1/2-in. NPT (C1); M20 (C2)	1	1/2-in. NPT (B1)	<ul style="list-style-type: none"> <li>• Smallest explosion proof connection head</li> <li>• Fits either DIN A or DIN B size transmitter</li> <li>• Optional terminal block, stainless steel cover chain, external ground screw, or low temperature options also available</li> </ul>	Most popular connection head, used for many applications
<b>Rosemount aluminum with display cover (AR2)</b> 	★★☆☆	Yes	1/2-in. NPT (C1); M20 (C2)	1	1/2-in. NPT (B1)	<ul style="list-style-type: none"> <li>• Allows LCD display use on the transmitter</li> <li>• Allows you to see inside the connection head without removing cover</li> <li>• Fits either DIN A or DIN B size transmitter</li> <li>• Optional terminal block, external ground screw, or low temperature options also available</li> </ul>	Used with transmitters with displays
<b>Rosemount SST (SR1)</b> 	★★★★☆	Yes	1/2-in. NPT (C1); M20 (C2)	1	1/2-in. NPT (B1)	<ul style="list-style-type: none"> <li>• Smallest explosion proof stainless steel connection head</li> <li>• Fits either DIN A or DIN B size transmitter</li> <li>• Optional terminal block, stainless steel cover chain, external ground screw, or low temperature options also available</li> </ul>	Pick this option if an explosionproof connection head is required in a corrosive environment.
<b>Rosemount SST with display cover (SR2)</b> 	★★★★☆	Yes	1/2-in. NPT (C1); M20 (C2)	1	1/2-in. NPT (B1)	<ul style="list-style-type: none"> <li>• Allows LCD display use on the transmitter</li> <li>• Allows for seeing inside the connection head without removing cover</li> <li>• Fits either DIN A or DIN B size transmitter</li> <li>• Optional terminal block, external ground screw, or low temperature options also available</li> </ul>	<ul style="list-style-type: none"> <li>• Use with transmitters with displays</li> <li>• Pick this option if an explosionproof connection head is required in a corrosive environment.</li> </ul>
<b>Aluminum with terminal strip (AT1)</b> 	★★☆☆	Yes	3/4-in. NPT (C3)	1	1/2-in. NPT (B1)	<ul style="list-style-type: none"> <li>• Big connection head that is easy to wire due to shallow terminal strip location</li> <li>• Optional stainless steel cover chain or external ground screw available</li> </ul>	Pick this option if wire termination is required without the use of a transmitter.

Head description (code)	Corrosion resistance	Explosionproof design	Conduit options <sup>(1)</sup>	Conduit entries	Instrument connection <sup>(1)</sup>	Features	Recommendations
<b>Aluminum with terminal strip and extended cover (AT3)</b> 	★★☆☆	Yes	3/4-in. NPT (C3)	1	1/2-in. NPT (B1)	<ul style="list-style-type: none"> <li>• Big connection head that is easy to wire due to shallow terminal strip location</li> <li>• Extended cover provides additional space within the connection head for wires</li> <li>• Optional stainless steel cover chain or external ground screw available</li> </ul>	Pick this option if wire termination is required without the use of a transmitter.
<b>Universal 3 entry aluminum junction box (AJ1)</b> 	★★☆☆	Yes	1/2-in. NPT or M20	2	1/2-in. NPT	<ul style="list-style-type: none"> <li>• Two conduit connection penetrations</li> <li>• Optional terminal block, external ground screw, and stainless steel cover chain available</li> </ul>	Pick this option if two conduit connections are required.
<b>Universal 3 entry aluminum junction box with display cover (AJ2)</b> 	★★☆☆	Yes	1/2-in. NPT or M20	2	1/2-in. NPT	<ul style="list-style-type: none"> <li>• Two conduit connection penetrations</li> <li>• Optional terminal block, external ground screw, and stainless steel cover chain available</li> </ul>	Pick this option if two conduit connections are required.

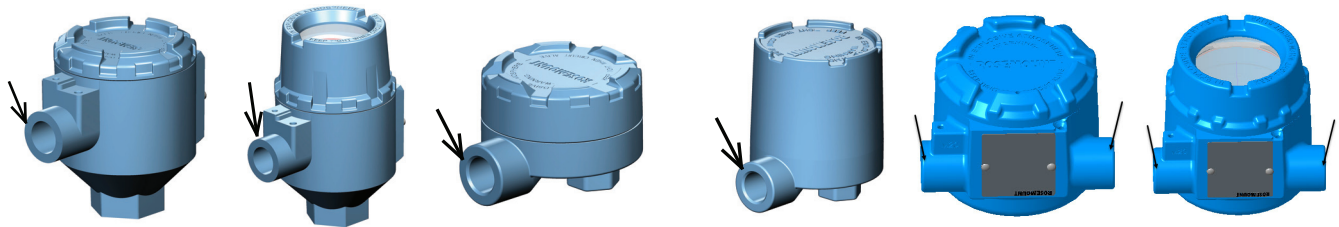
1. Option codes for the conduit entry and instrument connection are denoted within the parentheses. The conduit entry is the threaded opening between the connection head and the input/output wires. The instrument connection is the threaded opening between the connection head and the sensors.

## Conduit entry

[Back to RTD ordering table](#)

[Back to Thermocouple ordering table](#)

The conduit entry is the threaded opening on the side of the connection head, often connected to wiring conduit. It allows the input/output wires to pass into the connection head.



### 1/2-in. NPT (C1)

U.S. Standard connection thread with a 1/2-in. diameter

### M20 × 1.5 (C2)

Metric connection thread with a 20 mm diameter and a 1.5 mm fine pitch

### **3/4-in. NPT (C3)**

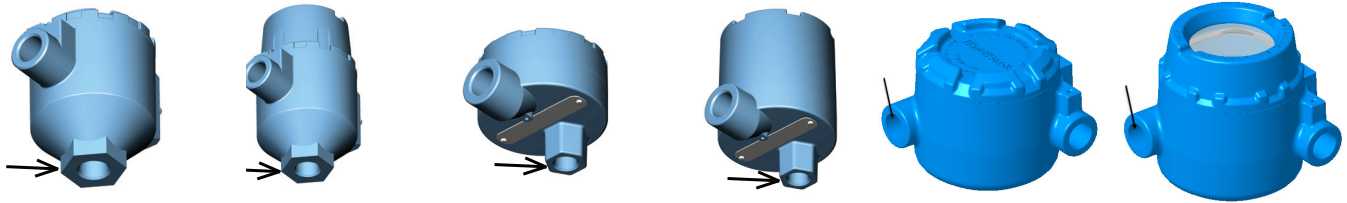
U.S. Standard connection thread with a 3/4-in. diameter

## **Instrument connection**

[Back to RTD ordering table](#)

[Back to Thermocouple ordering table](#)

The instrument connection is the threaded opening between the connection head and sensors.



### **1/2-in. NPT (B1)**

U.S. Standard connection thread with a 1/2-in. diameter



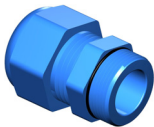
## **Conduit cable glands**

[Back to RTD ordering table](#)

[Back to Thermocouple ordering table](#)

Conduit cable glands are entry devices that allow for a cable or wires to pass to and from an enclosure while maintaining ingress protection rating. Proper installation of cable glands to the connection head is required to maintain hazardous location approvals and IP rating.

**Table 8. Conduit Cable Gland Specifications**

Ordering code	Description	Image	Material	Cable diameter range		IP rating
				For 1/2-in. NPT and M20	For 3/4-in. NPT	
GN1	Ex d, standard cable diameter		Nickel plated brass or 316SST	6.5–12.0 mm (0.26–0.47-in.)	13.0–20.2 mm (0.51–0.80-in.)	IP66/68, NEMA 4X
GN2	Ex d, thin cable diameter			3.2–8.0 mm (0.13–0.32-in.)	10.0–14.3 mm (0.39–0.56-in.)	
GN6	EMV, standard cable diameter			5.0–13.0 mm (0.20–0.51-in.)	13.0–20.2 mm (0.51–0.80-in.)	
GP1	Ex e, standard cable diameter		Polyamide	6.5–12.0 mm (0.26–0.47-in.)	13.0–18.0 mm (0.51–0.71-in.)	
GP2	Ex e, thin cable diameter			5.0–9.0 mm (0.20–0.35-in.)	9.0–16.0 mm (0.35–0.63-in.)	

## Extension type (UA, FA)

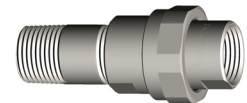
[Back to RTD ordering table](#)

[Back to Thermocouple ordering table](#)

Sensor assemblies can include extensions of various lengths to distance the transmitter from high process temperatures that may affect the transmitter electronics. Extensions can be a combination of unions, nipples, and/or couplings and can be connected to either a thermowell or the pipe for direct insertion assembly.

### Union style (UA)

- Adjustable union for ease of orienting the connection head
- All threads will be 1/2-in. NPT



### Fixed style (FA)

- Lower cost extension type
- Fixed coupling which does not allow for orienting the connection head
- All threads will be 1/2-in. NPT



## Extension length

[Back to RTD ordering table](#)

[Back to Thermocouple ordering table](#)

Each of the extension types are available in both English/U.S. customary or Metric units. Note the dimension units for each option will be the same as specified earlier in the ordering table (see “[Dimension units](#)” on page 26). When specifying the actual lengths, the following examples can be used.

English/U.S. customary units available from 2.5- to 20-in. (in 1/2-in. increments):

- 8.5-in. – E085
- 15-in. – E150

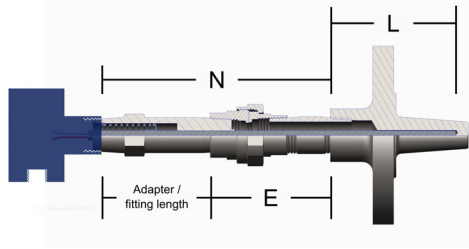
Metric available from 65 to 500 mm (in 5 mm increments):

- 80 mm – E080
- 485 mm – E485



### Specify an extension length from an “N” length

If “N” length is known, the adapter/fitting length needs to be subtracted to determine the extension length needed for the assembly.



Mounting style	Adapter length <sup>(1)</sup>
SL	58.93 mm (2.32-in.)
SC	29.21 mm (1.15-in.)
SW	66.04 mm (2.60-in.)
WA	58.93 mm (2.32-in.)
WC	29.21 mm (1.15-in.)
SA	29.21 mm (1.15-in.)

1. Adapter sizes assume 1/2-in. thread engagement.

$$E = N - (\text{adapter length})$$

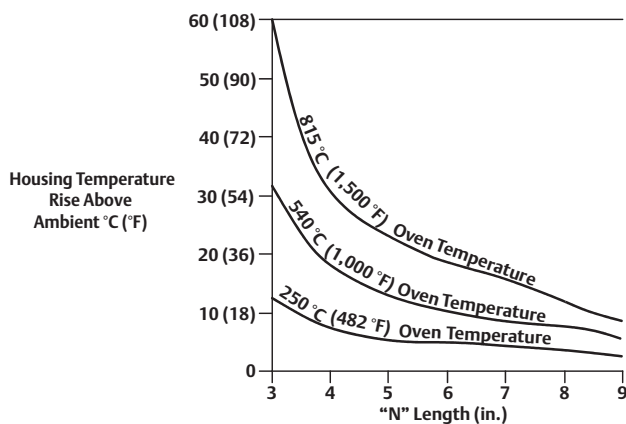
**Note**

Round the E length to the nearest 5 mm (1/4-in.).

**Selecting an extension**

Aside from ambient temperature variations, the heat from the process is transferred from the thermowell to the transmitter housing. If the process temperature is near or beyond specification limits, consider the use of additional thermowell lagging, an extension nipple, or a remote mounting configuration to isolate the transmitter from the excessive temperatures. Refer to Figure 17 and the corresponding example to approximate an adequate extension length.

**Figure 17. Rosemount Temperature Transmitter Housing Temperature Rise versus Extension Length for a Test Installation**



## Calibration

[Back to RTD ordering table](#)

### Calibration options

Sensor calibration may be required for input to quality systems or for control system enhancement, based on the local regulation requirements for maintaining measurement accuracies. More frequently, it is used to improve the overall temperature measurement performance by matching the sensor to a temperature transmitter.

Sensor matching is available for RTD sensors used with Emerson temperature transmitters where the inherent stability and repeatability of the RTD technology is well established.

### X91Q4: Single point calibration

The X91Q4 option documents the sensor's resistance at a single specified point. A calibration certificate with the resistance value at this point is supplied. Before specifying the point, take careful note of the sensor's temperature limits.

---

#### Note

The X91Q4 option can be ordered and used in conjunction with the X8Q4, V20Q4 - V27Q4 options. However, when ordering in conjunction with other calibration option codes, only specify one instance of "Q4".

---

### Callendar-Van Dusen Constants

Significant temperature measurement accuracy improvement can be attained using a temperature sensor that is matched to a temperature transmitter. This matching process entails teaching the temperature transmitter the relationship between resistance and temperature for a specific RTD sensor. This relationship, approximated by the Callendar-Van Dusen equation, is described as:

$R_t = R_0 + R_0\alpha[t - \delta(0.01t - 1)(0.01t) - \beta(0.01t - 1)(0.01t)^3]$ , where:

- $R_t$  = Resistance (ohms) at Temperature  $t$  (°C)
- $R_0$  = Sensor-Specific Constant (Resistance at  $t = 0$  °C)
- $\alpha$  = Sensor-Specific Constant
- $\delta$  = Sensor-Specific Constant
- $\beta$  = Sensor-Specific Constant (0 at  $t > 0$  °C, 0.11 at  $t < 0$  °C)

The exact values for  $R_0$ ,  $\alpha$ ,  $\delta$ ,  $\beta$ , – known as Callendar-Van Dusen (CVD) constants – are specific to each RTD sensor, and are established by testing each individual sensor at various temperatures.

The calibration temperature values using the CVD equation are divided into two major temperature areas: above 0 °C and below 0 °C. The calibration for the temperature range is obtained from the following formula:

$$R_t = R_0 \left\{ 1 + a \left[ t - d \left( \frac{t}{100} \right) \left( \frac{t}{100} - 1 \right) \right] \right\}$$

Note that this is a modification of the fourth-order CVD equation where  $\beta = 0$  for temperatures greater than 0 °C. Since this modified equation is a second-order equation, at least three distinct temperature values are needed in order to curve fit the behavior of the RTD. For the temperature range from 0 to 100 °C, only these two end points are used, and an approximation is made to render the constants.

Once the sensor-specific constants are entered, the transmitter uses them to generate a custom curve to best describe the relationship between resistance and temperature for the particular sensor and transmitter system. Matching a Rosemount 214C temperature sensor to an Emerson temperature transmitter typically results in a three- or four-fold improvement in temperature measurement accuracy for the measurement point. This substantial system accuracy improvement is realized as a result of the transmitter's ability to use the sensor's *actual* resistance-vs.-temperature curve instead of an ideal curve.

---

#### Note

An RTD ordered with the V option is shipped with CVD constants only; while resistance data for several temperature points is included, it does not include a full calibration table.

---

## V20Q4 - V27Q4: Calibration with A, B, C, and Callendar-Van Dusen constants to specific temperature ranges

Rosemount 214C sensors can be ordered with an option (i.e. V20Q4...V27Q4), that provides Callendar-Van Dusen constants and are shipped with the sensor. When you order this option, the values of all four sensor-specific constants are physically attached to each sensor with a wire-on tag. Emerson temperature transmitters have a unique, built-in sensor matching capability. To use this capability, the four sensor-specific constants are programmed into the transmitter at the factory by ordering a C2 option on the transmitter, or easily entered and changed in the field using a Field Communicator or AMS Device Manager. When these values are entered into an Emerson temperature transmitter, the sensor and transmitter become matched.

For applications requiring the increased accuracy obtainable through a matched sensor and transmitter, order the appropriate “V” option. To ensure optimal performance, select a “V” option such that the sensor’s range of actual operation is between the minimum and maximum calibration points.

Option code	Temperature range		Calibration points	
	°F	°C	°F	°C
V20Q4	32 to 212	0 to 100	32	0
			212	100
V21Q4	32 to 392	0 to 200	32	0
			212	100
			392	200
V22Q4	32 to 842	0 to 450	32	0
			212	100
			842	450
V23Q4	32 to 1112	0 to 600	32	0
			212	100
			1112	600
V24Q4	-58 to 212	-50 to 100	-58	-50
			32	0
			212	100
V25Q4	-58 to 392	-50 to 200	-58	-50
			32	0
			212	100
			392	200
V26Q4	-58 to 842	-50 to 450	-58	-50
			32	0
			212	100
			842	450
V27Q4	-76 to 1112	-60 to 600	-76	-60
			32	0
			212	100
			1112	600

### Note

The uncertainty of each measurement is  $\pm 0.1$  °C for temperatures equal to or less than 100 °C and  $\pm 0.3$  °C for temperatures greater than 100 °C.

## X8Q4: Calibration with A, B, C, and Callendar-Van Dusen constants to a custom specified temperature range

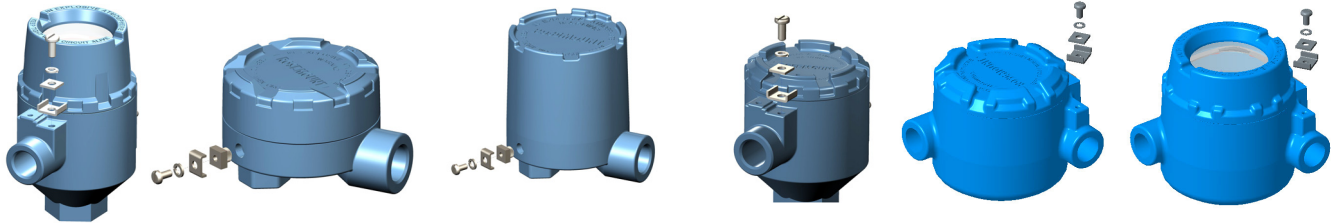
When an RTD with the X8Q4 option is ordered, a temperature range over which the sensor is to be calibrated must be specified. Before specifying the range, take careful note of the sensor’s temperature limits.

## Ground screw (G1)

[Back to RTD ordering table](#)

[Back to Thermocouple ordering table](#)

The external screw allows the users to ground wires to the connection head. Ground screw is 316 SST material.



## Cover chain (G3)

[Back to RTD ordering table](#)

[Back to Thermocouple ordering table](#)

The cover chain keeps the cover connected to the connection head when disassembled. Cover chain is 304 SST material.

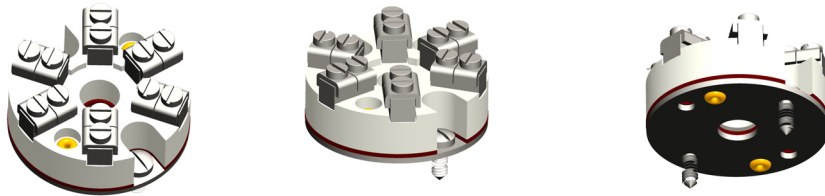


## Terminal block (TB)

[Back to RTD ordering table](#)

[Back to Thermocouple ordering table](#)

The terminal block is installed in the connection head and the sensor lead wires are terminated to one side of the terminal block. Terminal blocks are typically used when mounting remote transmitters.



## Low temperature housing (LT)

[Back to RTD ordering table](#)

[Back to Thermocouple ordering table](#)

Selecting this option allows the connection head to be compatible to  $-51\text{ }^{\circ}\text{C}$  ( $-60\text{ }^{\circ}\text{F}$ ).

## Transmitter assembled to sensor (XA, XC)

[Back to RTD ordering table](#)

[Back to Thermocouple ordering table](#)

### XA

This option is selected when a sensor is ordered with a transmitter. This option code ensures the sensor is threaded into the connection head and torqued for a process-ready installation, with the sensor wired to the terminal.

### XC

This option is selected when a sensor is ordered with a transmitter. This option code ensures the sensor is threaded into the connection head, but only hand tightened, and manual wiring of the sensor to the terminal is required.

---

#### Note

XC code does not meet hazardous location approval requirements. Refer to Rosemount 214C [Quick Start Guide](#) for proper installation.

---

## Thermowell assembled to sensor (XW, XT)

[Back to RTD ordering table](#)

[Back to Thermocouple ordering table](#)

### XW

This option is selected when a sensor is ordered with the Rosemount 114C Thermowell. It ensures the sensor is threaded into the thermowell and torqued for a process-ready installation.

### XT

This option is selected when a sensor is ordered with the Rosemount 114C Thermowell. It ensures the sensor is threaded into the thermowell, but only hand tightened.

---

#### Note

XT code does not meet hazardous location approval requirements. Refer to Rosemount 214C [Quick Start Guide](#) for proper installation.

---

## Extended product warranty (WR3, WR5)

[Back to RTD ordering table](#)

[Back to Thermocouple ordering table](#)

The extended product warranty options are available in three- or five-year coverage plans. In the model string, order option codes WR3 for a three-year extended warranty or WR5 for a five-year warranty. This coverage is an extension of the manufacturer's limited warranty and states that the goods manufactured or services provided by seller will be free from defects in materials or workmanship under normal use and care until the expiration of the applicable warranty period.

---

## Additional RTD specifications

---

### Note

All specifications in this section apply to all RTD unless noted otherwise.

---

### Insulation resistance

1000 M $\Omega$  minimum insulation resistance when measured at 500 VDC at room temperature.

### Insulation resistance at elevated temperature

Sensor Type RT: 400 M $\Omega$  minimum insulation resistance when measured at 500 VDC at 450 °C.

Sensor Type RH: 5 M $\Omega$  minimum insulation resistance when measured at 500 VDC at 600 °C.

Sensor Type RW: 800 M $\Omega$  minimum insulation resistance when measured at 500 VDC at 300 °C.

### Time response

10.8 seconds maximum required to reach 50 percent sensor response when tested in flowing water according to IEC 60751:2008

### Stability

$\pm 0.15$  °C (0.059  $\Omega$ ) maximum ice-point resistance shift for Class A and  $\pm 0.3$  °C (0.117  $\Omega$ ) for Class B following 1,000 hours at maximum specified temperature when measured per methods defined in IEC 60751:2008.

### Effects of temperature cycling

$\pm 0.15$  °C (0.059  $\Omega$ ) maximum ice-point resistance shift for Class A and  $\pm 0.3$  °C (0.117  $\Omega$ ) for Class B following 10 cycles over the maximum specified temperature range when measured per methods defined in IEC 60751:2008.

### Hysteresis

Sensor Type RT:  $\pm 1.3$  °C (0.478  $\Omega$ ) maximum resistance shift for Class B when measured at 200 °C per methods defined in IEC 60751:2008.

Sensor Type RH:  $\pm 1.65$  °C (0.593  $\Omega$ ) maximum resistance shift for Class B when measured at 270 °C per methods defined in IEC 60751:2008.

Sensor Type RW:  $\pm 0.25$  °C (0.096  $\Omega$ ) maximum resistance shift for Class A sensors and  $\pm 0.55$  °C (0.212  $\Omega$ ) for class B when measured at 50 °C per methods defined in IEC 60751:2008.

### Self heating

An average of 0.32 °C/mW is found when measured per method defined in IEC 60751:2008.

## Process immersion

Sensor Type RT, Single: Max Minimum Immersion Depth = 30 mm measured in 100 °C water according to IEC 60751:2008

Sensor Type RT, Dual: Max Minimum Immersion Depth = 45 mm measured in 100 °C water according to IEC 60751:2008

Sensor Type RH, Single: Max Minimum Immersion Depth = 40 mm measured in 100 °C water according to IEC 60751:2008

Sensor Type RH, Dual: Max Minimum Immersion Depth = 40 mm measured in 100 °C water according to IEC 60751:2008

Sensor Type RW, Single and Dual: Max Minimum Immersion Depth = 50 mm measured in 100 °C water according to IEC 60751:2008

## Vibration limits

Sensor Type RT and RH: 0.05 °C (0.020) maximum ice-point resistance shift after 3g vibration between 20 and 500 Hz for 150 hours according to IEC 60751:2008.

Sensor Type RW: 0.05 °C (0.020) maximum ice-point resistance shift after 1g vibration between 20 and 500 Hz for 150 hours according to IEC 60751:2008.

## Lead wires

Lead wires -24 AWG wire, FEP insulated; color coded per IEC 60751.

# Additional thermocouple specifications

---

### Note

All specifications in this section apply to all thermocouple types unless noted otherwise.

---

## Insulation resistance

1000 M $\Omega$  minimum insulation resistance when measured at 500 VDC at room temperature.

## Time response

Grounded thermocouples: 2.2 seconds maximum required to reach 50 percent sensor response when tested in flowing water according to IEC 61515:2016.

Ungrounded thermocouples: 3.2 seconds maximum required to reach 50 percent sensor response when tested in flowing water according to IEC 61515:2016.

## Process immersion

Grounded thermocouples: Max minimum immersion depth = 5 mm measured in 100 °C water according to IEC 61515:2016.

Ungrounded thermocouples: Max minimum immersion depth = 10 mm measured in 100 °C water according to IEC 61515:2016.

## Continuity


Electrical continuity of each conductor pair is verified. For a grounded junction thermocouple, electrical continuity of each pair of conductors to sheath are verified.

## Lead wires

Lead wires –24 AWG wire, FEP insulated; color coded per IEC 60584 or ASTM E230.




## Global Headquarters

### Emerson Automation Solutions

6021 Innovation Blvd.  
Shakopee, MN 55379, USA  
 +1 800 999 9307 or +1 952 906 8888  
 +1 952 949 7001  
 RFQ.RMD-RCC@Emerson.com




## North America Regional Office

### Emerson Automation Solutions

8200 Market Blvd.  
Chanhassen, MN 55317, USA  
 +1 800 999 9307 or +1 952 906 8888  
 +1 952 949 7001  
 RMT-NA.RCCRFQ@Emerson.com




## Latin America Regional Office

### Emerson Automation Solutions

1300 Concord Terrace, Suite 400  
Sunrise, FL 33323, USA  
 +1 954 846 5030  
 +1 954 846 5121  
 RFQ.RMD-RCC@Emerson.com

## Europe Regional Office

### Emerson Automation Solutions Europe GmbH

Neuhofstrasse 19a P.O. Box 1046  
CH 6340 Baar  
Switzerland  
 +41 (0) 41 768 6111  
 +41 (0) 41 768 6300  
 RFQ.RMD-RCC@Emerson.com

## Asia Pacific Regional Office


### Emerson Automation Solutions

1 Pandan Crescent  
Singapore 128461  
 +65 6777 8211  
 +65 6777 0947  
 Enquiries@AP.Emerson.com

## Middle East and Africa Regional Office


### Emerson Automation Solutions

Emerson FZE P.O. Box 17033  
Jebel Ali Free Zone - South 2  
Dubai, United Arab Emirates  
 +971 4 8118100  
 +971 4 8865465  
 RFQ.RMTMEA@Emerson.com

 [Linkedin.com/company/Emerson-Automation-Solutions](https://www.linkedin.com/company/Emerson-Automation-Solutions)

 [Twitter.com/Rosemount\\_News](https://twitter.com/Rosemount_News)

 [Facebook.com/Rosemount](https://www.facebook.com/Rosemount)

 [Youtube.com/user/RosemountMeasurement](https://www.youtube.com/user/RosemountMeasurement)

 [Google.com/+RosemountMeasurement](https://www.google.com/+RosemountMeasurement)

Emerson Terms and Conditions of Sale are available upon request.  
The Emerson logo is a trademark and service mark of Emerson Electric Co. Rosemount is a mark of one of the Emerson family of companies.  
All other marks are the property of their respective owners.  
© 2018 Emerson. All rights reserved.