

# Emerson Deepwater Offshore Solutions

Proven Fisher® technology to mitigate risks and meet production targets

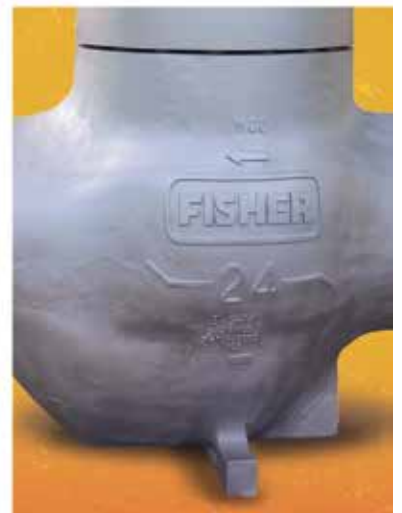

**“Unplanned maintenance or shutdowns put my personnel and process at risk. High operating costs and declining production prevent me from reaching the target return on our production assets.”**

As offshore exploration activities continue to increase and drilling deepens, the risks to your assets compound. If your equipment isn't running at its best in remote and extreme environments, you put your personnel at risk. Common process upsets caused by inefficient control valves can negatively impact your production uptime, increasing operational costs and the chances of a safety incident.

### What if you could...

- + MAXIMIZE PRODUCTION with proven technology, durable equipment, and application expertise? *pages 4-7*
- + REDUCE OPERATIONAL COSTS and risks to your personnel with proven-reliable technology? *pages 8-10*
- + INCREASE UPTIME by having access to reliable control valve service and support? *page 11*

**Mitigate risks and meet production targets with proven Fisher® technology for your critical valve applications:**

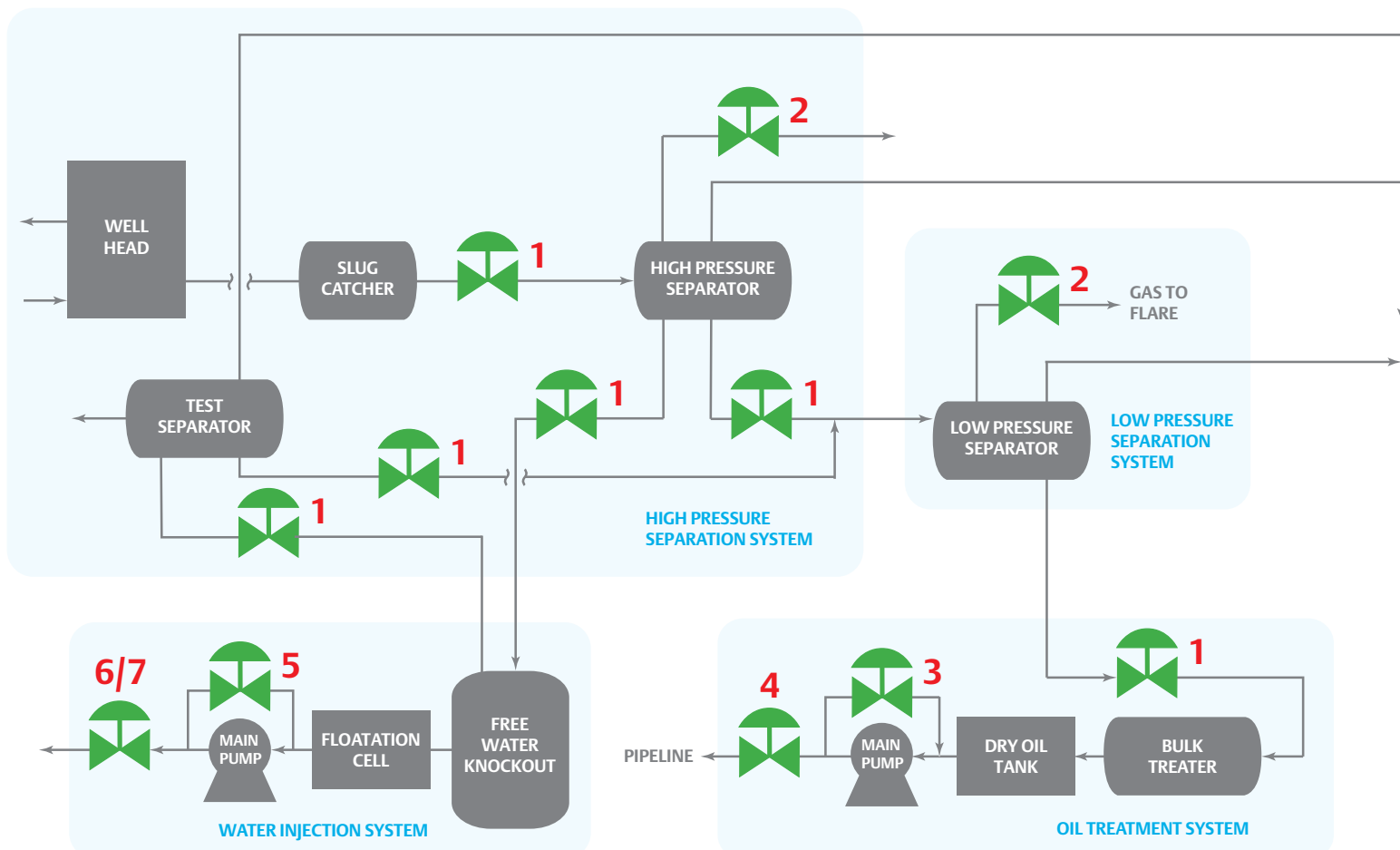



**1**  
**Level Control Valve**  
▶ more on pages 6 & 7



**2**  
**Gas to Flare Valve**  
▶ more on page 4



**3**  
**Oil Pump Recirculation Valve**



**4**  
**Oil Pump Discharge Valve**



**5**  
**Water Injection Pump Recirculation Valve**  
▶ more on page 5



**6**  
**Water Injection Valve**  
▶ more on page 5



**7**  
**Water Overboard Valve**

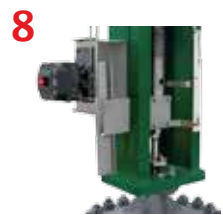

**8**  
**Compressor Antisurge Valve**  
▶ more on page 9



**9**  
**Gas Injection Valve**  
▶ more on page 6



**10**  
**Glycol Contactor Level Control Valve**  
▶ more on page 6

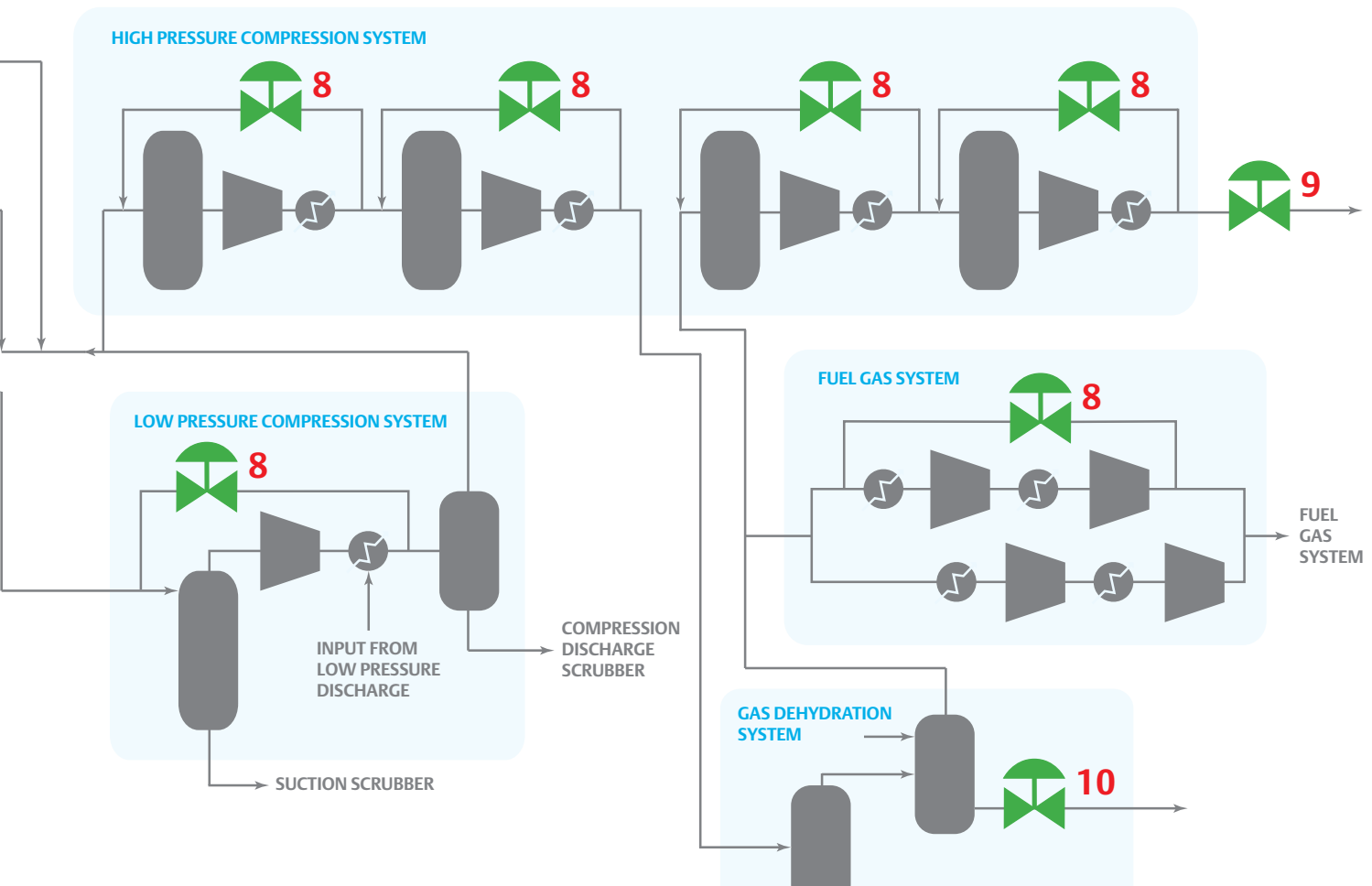

## MAXIMIZE PRODUCTION

A lot goes into the sizing and selection of a control valve. A procedure based on sound engineering principles, coupled with real-world knowledge of your process, helps determine the valve selections that are most appropriate for your production requirements. Total comprehension of this procedure, your process, and the engineered specifications of your applications are critical to helping you reach your production targets.

By partnering with Emerson, you can work alongside a team of application experts who are dedicated to solving your toughest offshore challenges. Our engineers carry out the sizing and selection of your control valve equipment with precision for detail. This helps you reach your production targets and gain confidence in your process.

### Reduce Noise and Improve Output

Gas-to-flare systems are an integral part of many deepwater offshore assets. They safeguard against the overpressure of critical equipment and are vital to the start-up, shut-down, and short-duration upsets of your offshore production platform.

Like any critical application, the gas-to-flare application comes with its challenges. Significant pressure drops and high flow rates across the valve are the primary concerns. If these issues are not taken into account during the valve sizing and selection process, excessive noise levels and even damaging vibration can occur, resulting in production interruptions, safety incidents, or environmental fines.



*Fisher HP control valve with Whisper trim™  
(often used in gas-to-flare applications)*

Emerson engineers use aerodynamic noise modeling and prediction technology to account for independent trim and valve body noise, leaving you with a customized valve solution that best fits your large pressure drop applications. This comprehensive approach incorporates field-proven, noise-attenuating valve trims, like Fisher Whisper III trim, to reduce noise and prevent damaging vibration. When you're able to control noise effectively, you can keep production running smoothly and safely.



*Laser shadowgraphs show jet independence from three properly spaced holes (left). The same three holes spaced too closely (right) show jet interaction, which leads to additional noise. Being able to predict and control jet interaction can reduce the noise produced by up to 40 dBA.*

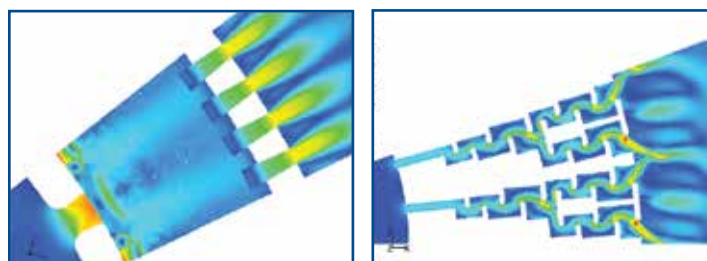

*A top-down look at flow through Fisher WhisperFlo™ trim (left) using computational fluid dynamics illustrates the independence of fluid jets as they exit the cage. In contrast, the exit jets of some tortuous path trims (right) impinge upon one another in pairs, creating an additional noise source.*



## Combat Corrosion, Mitigate Erosion, and Increase Recovery

Water injection systems can be one of the most difficult applications on your offshore asset. Because they serve to significantly increase extraction, these systems are essential to meeting production targets. High-pressure water is injected into the well to dispose of water recovered from processing or to help facilitate product flow by maintaining reservoir pressure. While sea water is often the most convenient source for this system, it also presents its own unique set of challenges unlike those that exist onshore.

The pressures at the bottom of the ocean and down the wellbore are much greater than those on the surface. However, the inherently corrosive nature of seawater could be the most difficult characteristic to combat. Its alkalinity, or pH, can cause a chemical reaction that quickly degrades your control valve equipment. Sand, microorganisms, and other particulates, combined with the high pressure drops can shorten control valve life by plugging the cage and causing material erosion or corrosion of the plug, cage, and seat. Damage to the control valve body may also occur. These issues compromise your production efforts and may shutdown your process.

With a variety of valve materials suited for corrosion resistance, Emerson engineers can help you select a valve construction that will endure even the harshest conditions. Designed specifically for dirty service applications, Fisher dirty service trim technologies allow particulate to pass, while resisting or eliminating cavitation or process particulate damage. The use of corrosion-resistant alloys, such as super duplex steel in trim components, can help reduce chloride pitting and stress corrosion cracking to promote longer service life and tighter shutoff.



Scan this QR code to learn more about solutions for cavitation control.

## MATERIALS MATTER.

We've got you covered:

**Tungsten Carbide**

**Super Duplex**

**Duplex**

**Ceramic**

**Ferrallium**

**Inconel**

**Aluminum Bronze**

**Monel**

**254 SMO**

**Superaustenitic**

**WCC**

**316sst**

**440C**

**Titanium**

## PROVEN RESULTS

**APPLICATION:** The water injection system of an offshore platform in the Gulf of Mexico

**CHALLENGE:** Subjected to pressure drops as high as 10,000 psi (689.5 bar) and abrasive sea water, valves in this application are prone to clogging, severe cavitation damage, and corrosion. Valve failures were costing the facility 3000 barrels in lost production per day.

**SOLUTION:** Using Fisher HP valves fitted with Cavitrol™ trim—designed to eliminate cavitation, as opposed to containment—the platform was able to increase runtime of the waterflood system by nearly 80%. With Fisher Lifecycle Services' Quick Ship delivery, the application was restarted 15 weeks sooner than planned, saving the platform more than \$300,000 USD per day.

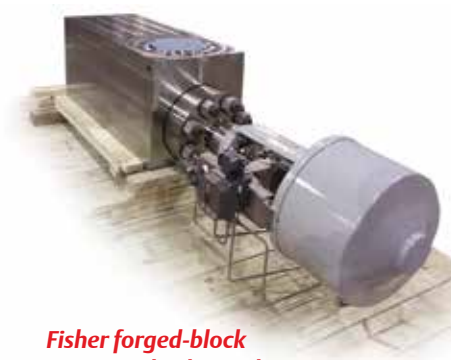

Fisher forged-block HP control valve with Cavitrol IV trim

## MAXIMIZE PRODUCTION

### Full Range Equipment for Variable Pressures

Like water injection, gas lift and gas injection are methods used to increase production as the well ages. In this application, gas injection may also be used as a way to dispose of unwanted gas production. In either case, the valves are subjected to high pressures and large pressure drops and must be able to maintain sufficient uptime. With little opportunity to change out the valve—not to mention the high cost of doing so—proper engineering and configuration up front is critical.

Emerson engineers understand that the success of the gas lift and gas injection methods are directly tied to the initial design of the control valve. When you require thorough engineering and high quality standard design, Fisher high pressure control valves (HP series) provide a thicker valve body wall for extra protection against erosion and corrosion.



*Fisher valves are factory-tested beyond standard requirements for tight shutoff and endurance to extend service life and ensure you achieve optimum production. Scan the QR code to learn more about Fisher solutions for noise abatement.*



*Identifying application challenges during the engineering of a valve is crucial to ensuring valve reliability and more importantly, ensuring the safety of your personnel.*

### Optimized Level Control

Carefully managing the levels of oil, water, and glycol is critical to ensuring you get the highest quality product. Level control valves and controllers are integral in separating water, gas, and other constituents from the oil before it is shipped from the offshore production asset. The erosive qualities associated with deep water extraction, like sand and salt particulates, put these valves under a lot of stress. Flashing, erosion, and high vibration only add to what is already a critical application.

With these issues in mind, Emerson has a variety of Fisher valves, trims, and materials to handle the challenging level control applications found on your offshore asset.

## Dependable Performance Across the Board

Emerson uses innovative engineering practices to give you high-performing, reliable solutions specifically for precise level control. The rugged Fisher easy-e™ sliding-stem control valve has undergone extensive flow testing and evaluation, yielding a robust control valve that is the industry standard for dependability and longevity. And, with interchangeable trim parts, the easy-e valve allows you to minimize your valve investment while maximizing your control options. You'll quickly understand why over a million units have been installed globally in a broad range of applications.

Also available, the Fisher Vee-Ball™ rotary control valve with its V-notch ball provides positive shearing action and a nearly equal percentage flow characteristic. It is essential to the accuracy and controllability of your system and provides non-clogging, high capacity flow control of your gas, steam, and clean or dirty fluids. Extensive flow loop testing has demonstrated the Vee-Ball valve's low friction performance advantage in controlling process variability.

Both the easy-e valve and the Vee-Ball valve can be coupled with a full range of Fisher actuators and FIELDVUE™ digital valve controllers to yield compact, easy-to-handle control valve assemblies. All components are engineered to work together to deliver dynamic performance and reliability.

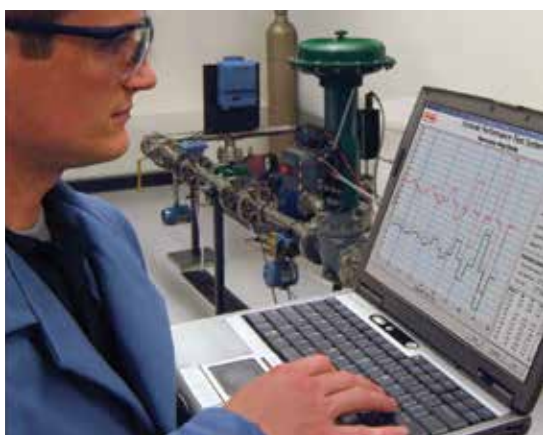

***Fisher control valve assemblies are subjected to in-line dynamic performance testing to evaluate their ability to reduce process variability.***



## EXCEEDING EXPECTATIONS

Every Fisher control valve design received Lloyd's Register's Marine Type Approval for process applications within the offshore oil and gas production industry, including those high integrity control valve applications that could potentially affect the safe operation of the offshore installation. In fact, all Fisher products have been thoroughly tested per Lloyd's Register requirements to confirm compliance with marine industry standards. All product designs have been certified to meet rigorous offshore codes and standards.

In addition to Marine Type Approval, Emerson facilities in all world areas have been approved to manufacture products certified to Lloyd's Register Marine rules. And one more thing—no other control valve supplier in the world can say the same.

Scan the code to learn more about what the Lloyd's approval could mean for maximizing your production efforts.





## REDUCE OPERATIONAL COSTS

For years, reactive and routine maintenance has been the standard approach to valve and instrument care in the oil & gas industry. “Run-to-fail” often seemed like the most cost-effective option. A traditional alternative to the run-to-fail strategy is schedule-based maintenance where inspections and refurbishments are performed to a schedule—whether they are necessary or not. As offshore production grows and technology expectations increase, it’s evident that reactive and schedule-based maintenance is not a sustainable strategy.

By implementing field-proven control valves and instruments from the very start of your planning and designing process, you can optimize your maintenance program, streamline your process, improve your performance, and protect your personnel.



*Using a valve signature series test, you can easily track the operating health of your control valve without removing it from the line.*

### The Control Valve You Choose Matters

When you buy Fisher control valves, you get the application expertise that comes from more than a century of oil & gas production experience. Plus you benefit from millions of dollars of research invested in reliability-centric testing of Fisher control valve technologies.

Fisher product specifications are, in many cases, more stringent than the industry accepted standards set by regulatory agencies. Our attention to and evaluation of product quality is necessary to bring you Fisher technologies of the highest reliability and performance. Fisher technology development capabilities extend worldwide with engineers and labs in North America, Europe, and Asia.

Using Fisher technology can help you achieve efficient, productive, and reliable plant operation. Want to see for yourself? Visit the Emerson Innovation Center for Fisher Technology in Marshalltown, Iowa, USA. To schedule a visit, please contact your local Emerson sales office.



*Scan the code to watch how Fisher products are rigorously tested to meet safety and performance standards.*







*By moving the compressor's operating point closer to the surge limit line, you can operate more efficiently.*

## Safely Operate Closer to Compressor Limits

Compressors can be the most critical and expensive components on your offshore asset. To minimize unplanned downtime, equipment damage, and risks to personnel safety, it's critical to have a system and valve that recognize an impending surge condition and take immediate action to prevent it.

Typical methods for maintaining surge control include either a blow-off to atmosphere or recirculation from the outlet to the inlet of the compressor. The anti-surge control strategy is tightly integrated with the compressor load control strategy. The control strategy requires not only a fast-acting controller, but a fast-acting valve with properly selected noise-attenuating and vibration-reducing trim to release or recirculate the flow.

Fisher optimized digital valves (ODV) and the predictive diagnostic capability of the FIELDVUE digital valve controller make it easier for operators to protect the compressor and ensure valves are working properly. Using the FIELDVUE digital valve controller, you can remotely check for valve packing friction, air leaks, stuck valves, and even analyze valve health while in-service or offline. With an antisurge valve that moves with greater speed, precision, and control, you can push the compressor's operating point closer to the surge limit—increasing efficiency, while avoiding process upsets and compressor failure. Fisher control valves and instruments exhibit industry-leading dynamic performance.

*The FIELDVUE digital valve controller offers antisurge-specific tuning capability that is an integral part of the Fisher ODV package.*



*Scan the code to learn more about the FIELDVUE DVC6200 digital valve controller with stainless steel housing to handle abrasive offshore environments.*

## REDUCE OPERATIONAL COSTS

### Flow Stability Means Improved Uptime

Extreme water depths mean extreme conditions, like frigid temperatures, high pressures, and corrosion. Such severe temperatures, pressures, and pressure drops can result in the formation of ice-like structures, called hydrates. Hydrates can cause large plugs that block piping and other equipment, causing them to become inoperable. High pressure and low flow rates can also cause erosion, often requiring increased valve maintenance or costly downtime.

Mono-ethylene glycol (MEG) is used as a freeze-protectant to help inhibit the formation of hydrates. MEG injection control valves regulate the flow of MEG and are critical to providing precise and continuous MEG dosage, as even the smallest percentage loss of MEG dosage can lead to hydrate formation.

Tested to the highest requirements, including seat leakage, packing emission, cavitation, and erosion, Fisher control valves and instruments used in MEG injection applications are designed to prevent erosion damage to the seat and plug to maintain integrity for tight shutoff and precise, continuous flow control. The valve plug and seat ring are uniquely matched to regulate flow during very low flow and high pressures. A valve with built-in reliability means preventing hydrates from the start, so you can meet the flow requirement and attain the highest performance from your process.



*Fisher HP control valve with Cavitrol III micro-flat trim (often used in MEG injection applications)*



*Fisher control valves shown in an offshore environment.*

## INCREASE UPTIME

### Improved Availability and Dependable Support

The way you manage key production assets like control valves directly affects your plant's efficiency, reliability, and profitability. Emerson Process Management's Fisher Services provides trusted expertise for control valve maintenance and repair.

Whether you're starting or commissioning a process, scheduling diagnostics and repair, or planning a turnaround with upgrades to optimize and extend your plant's lifecycle, our network of owned and authorized service centers around the world provide effective maintenance through a network of experienced, highly skilled technicians when and where you need them.

To help you maintain your plant's efficiency and reliability, Fisher Services uses only certified OEM parts and assemblies sourced through local inventories, regional parts distribution centers, and Quick Ship facilities to deliver unmatched response to customer needs.





To learn more, visit [Fisher.com/OilandGas](http://Fisher.com/OilandGas) or contact your local Emerson sales office. Take advantage of the many benefits of Fisher solutions today.



 <http://www.Facebook.com/FisherValves>

 <http://www.Twitter.com/FisherValves>

 <http://www.YouTube.com/user/FisherControlValve>

 <http://www.Linkedin.com/groups/Fisher-3941826>

© 2014 Fisher Controls International LLC. All rights reserved.

Fisher, Whisper Trim, WhisperFlo, Cavitrol, easy-e, Vee-Ball, and FIELDVUE are marks owned by one of the companies in the Emerson Process Management business unit of Emerson Electric Co. Emerson Process Management, Emerson, and the Emerson logo are trademarks and service marks of Emerson Electric Co. All other marks are the property of their respective owners.

The contents of this publication are presented for informational purposes only, and while every effort has been made to ensure their accuracy, nothing herein is to be construed as a warranty or guarantee, express or implied, regarding the products or services described herein or their use, performance, merchantability or fitness for a particular purpose. Individual results may vary. All sales are governed by our terms and conditions, which are available upon request. We reserve the right to modify or improve the designs or specifications of our products at any time without notice. Responsibility for proper selection, use and maintenance of any product or service remains solely with the purchaser and end user.

**Emerson Process Management**  
Marshalltown, Iowa 50158 USA  
Sorocaba, 18087 Brazil  
Chatham, Kent ME4 4QZ UK  
Dubai, United Arab Emirates  
Singapore 128461 Singapore  
[www.Fisher.com](http://www.Fisher.com)

