



# Model B73 & Series 75 Sealed External Cage Liquid Level Switches

## DESCRIPTION

Sealed external cage type level switches are completely self-contained units designed for side mounting to a tank or vessel with threaded or flanged pipe connections. These units are an industry standard in petroleum refineries and chemical plants. Thousands of these switches are in daily service throughout the world.

## FEATURES

- Carbon steel or stainless steel welded float chamber
- Service pressures up to 2240 psig (154 bar)
- Process temperatures up to +1000 °F (+538 °C); Consult factory for process temperatures up to +1200 °F (+650 °C)
- Specific gravity ratings as low as 0.32
- Available switch styles including dry contact, hermetically sealed and pneumatic
- Single or multiple switch mechanisms available
- Available switch enclosures include:
  - NEMA 1 carbon steel for pneumatics
  - TYPE 4X/7/9 Class I, Div. 1 Groups C & D or Groups B, C & D polymer coated aluminum
- 1", 1½", or 2" tank connections available in either NPT, socket weld, flanged side/side or flanged side/bottom construction
- Optional high temperature insulation available. See bulletin 41-106.

## TECHNOLOGY

A permanent magnet ① is attached to a pivoted switch actuator and adjustment screw ②. As the float ③ rises following the liquid level, it raises the attraction sleeve ④ into the field of the magnet, which then snaps against the non-magnetic enclosing tube ⑤, actuating the switch ⑥. The enclosing tube provides a static pressure boundary between the switch mechanism and the process. On a falling level, an inonel spring retracts the magnet, deactivating the switch.





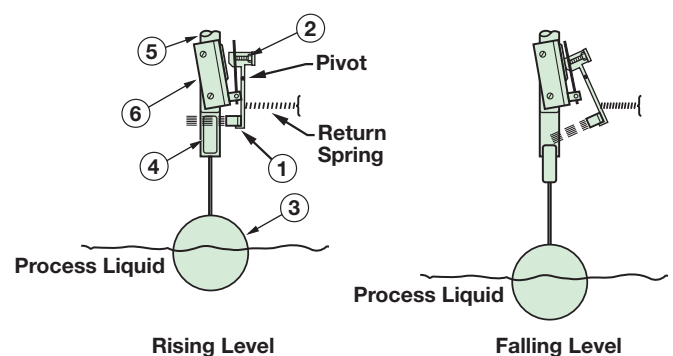

## APPLICATIONS

- Accumulators
- Receivers
- Flare pots
- Scrubbers
- Oil refineries
- Steam and electric generating stations
- Flash tanks
- Knockout drums
- Storage tanks
- Separators
- Chemical processing plants



# AGENCY APPROVALS

AGENCY	APPROVED MODEL	AREA CLASSIFICATION
<b>FM</b> 	All with an electric switch mechanism and a housing listed as TYPE 4X/7/9	Class I, Div 1, Groups C & D Class II, Div 1, Groups E, F & G
	All with an electric switch mechanism and a housing listed as TYPE 4X/7/9 Class I, Div 1, Group B	Class I, Div 1, Groups B, C & D Class II, Div 1, Groups E, F & G
<b>CSA</b> 	All with a Series HS, F, 8 or 9 electric switch mechanism and a housing listed as CSA TYPE 4X	Class I, Div 2, Groups A, B, C & D
	All with an electric switch mechanism and a housing listed as TYPE 4X/7/9	Class I, Div 1, Groups C & D Class II, Div 1, Groups E, F & G
	All with an electric switch mechanism and a housing listed as TYPE 4X/7/9 Class I, Div 1, Group B	Class I, Div 1, Groups B, C & D Class II, Div 1, Groups E, F & G
<b>ATEX / IEC Ex</b> ② 	All with an electric switch mechanism and an ATEX housing ①	ATEX II 2 G EEx D IIC T6 94/9/EC IEC Ex Ex d IIC T6 IP66
<b>CE</b> 	Low Voltage Directives 2006/95/EC Per Harmonized Standard: EN 61010-1/1993 & Amendment No. 1	Installation Category II Pollution Degree 2

① Models with two HS switches are not ATEX approved.

② IEC Installation Instructions: The cable entry and closing devices shall be Ex d certified suitable for the conditions of use and correctly installed. For ambient temperatures above +55 °C or for process temperatures above +150 °C, suitable heat resistant cables shall be used. Heat extensions (between process connection and housing) shall never be insulated.

### Special conditions for safe use:

When the equipment is installed in process temperatures higher than +85 °C the temperature classification must be reduced according to the following table as per IEC60079-0.

Maximum Process Temperature	Temperature Classification
< 85 °C	T6
< 100 °C	T5
< 135 °C	T4
< 200 °C	T3
< 300 °C	T2
< 450 °C	T1

These units are in conformity with IECEx KEM 05.0020X  
Classification Ex d IIC T6  
T<sub>ambient</sub> -40 °C to +70 °C

## BASIC ELECTRICAL RATINGS

Voltage	Switch Series and Non-Inductive Ampere Rating							
	B	C	D	F	HS	R	8	9
120 VAC	15.00	15.00	10.00	2.50	5.00	1.00	1.00	—
240 VAC	15.00	15.00	—	—	5.00	1.00	—	—
24 VDC	6.00	6.00	10.00	4.00	5.00	1.00	3.00	0.50
120 VDC	0.50	1.00	10.00	0.30	0.50	0.40	—	—
240 VDC	0.25	0.50	3.00	—	0.25	—	—	—

## DIMENSIONAL SPECIFICATIONS

### CARBON STEEL CHAMBERS WITH 1½-INCH CONNECTIONS

#### INCHES

#### MILLIMETERS

	Min. <sup>①</sup> SG	NPT & Socket Weld			Flanged Upper Side/Btm			Flanged Side/Side			Actuating Levels <sup>②</sup>		NPT & Socket Weld			Flanged Upper Side/Btm			Flanged Side/Side			Actuating Levels <sup>②</sup>					
		A	B	C	A	B	C	A	B	C	HL	LL	A	B	C	A	B	C	A	B	C	HL	LL				
														HL	LL												
B75	0.67	8.94	4.22	23.06	12.56	7.69	26.69	13.21	7.69	27.34	1.93	2.61	227	107	586	319	195	678	336	195	694	49	66				
C75	0.55										1.93	2.61										49	66				
F75	0.55	11.06	5.75	26.19	14.78	9.19	29.92	15.39	9.19	30.53	1.08	1.66	281	146	665	375	233	760	391	233	775	27	42				
G75	0.53	9.62	4.75	24.09	13.31	8.19	27.75	13.96	8.19	28.42	1.59	2.25	244	121	612	338	208	705	355	208	722	40	57				
J75	0.48										2.23	2.95										56	74				
K75	0.39	12.06	5.75	27.14	15.56	9.19	30.64	16.21	9.19	31.29	1.77	2.39	306	146	689	395	233	778	412	233	795	44	60				
L75	0.40	9.62	4.75	24.09	13.31	8.19	27.75	13.96	8.19	28.42	1.78	2.52	244	121	612	338	208	705	355	208	722	44	64				
N75	0.32	12.06	5.75	27.14	15.56	9.19	30.64	16.21	9.19	31.29	1.81	2.49	306	146	689	395	233	778	412	233	306	45	63				
S75	0.60	Consult Factory										n/a	n/a	Consult Factory										n/a	n/a		
V75	0.74	8.82	4.22	23.20	12.56	7.68	26.94	13.21	7.68	27.79	1.94	2.69	224	107	589	319	195	684	336	195	706	49	68				
Z75	0.68	9.51	4.75	24.09	13.31	8.18	27.89	13.96	8.18	28.54	1.69	2.59	242	121	612	338	208	708	355	208	725	43	66				

Levels are ±0.25" (6 mm)

CARBON STEEL CHAMBERS WITH 2-INCH CONNECTIONS  
INCHES

MILLIMETERS

	Min <sup>①</sup> SG	NPT & Socket Weld			Flanged Upper Side/Btm			Flanged Side/Side			Actuating Levels <sup>②</sup>		NPT & Socket Weld			Flanged Upper Side/Btm			Flanged Side/Side			Actuating Levels <sup>②</sup>	
		A	B	C	A	B	C	A	B	C	HL	LL	A	B	C	A	B	C	A	B	C	HL	LL
B75	0.67	8.69	4.34	23.20	12.56	7.69	26.07	13.21	7.69	27.72	1.48	2.16	221	110	589	319	195	662	336	195	704	37	54
C75	0.55										1.64	2.36										41	59
F75	0.55	10.94	5.88	26.32	14.78	9.19	30.16	15.39	9.19	30.77	0.78	1.36	278	149	669	375	233	766	391	233	782	19	34
G75	0.53	9.50	4.88	24.21	13.31	8.19	28.02	13.96	8.19	28.67	1.31	1.97	241	124	615	338	208	712	355	208	728	33	50
J75	0.48										1.95	2.67										49	67
K75	0.39	11.94	5.88	27.32	15.56	9.19	30.94	16.21	9.19	31.59	1.59	2.21	303	149	694	395	233	786	412	233	802	40	56
L75	0.40	9.50	4.88	24.21	13.31	8.19	28.02	13.96	8.19	28.67	1.50	2.24	241	124	615	338	208	712	355	208	728	38	56
N75	0.32	11.94	5.88	27.32	15.56	9.19	30.94	16.21	9.19	31.59	1.63	2.31	303	149	694	395	233	786	412	233	802	40	58
S75	0.60	Consult Factory									n/a	n/a	Consult Factory									n/a	n/a
V75	0.74	8.49	4.34	23.27	12.56	7.68	27.34	13.21	7.68	27.99	1.88	2.63	216	110	591	319	195	694	336	195	711	48	67
Z75	0.68	9.31	4.87	24.16	13.31	8.18	28.16	13.96	8.18	28.81	1.44	2.25	236	124	614	338	208	715	355	208	732	37	57

Levels are ±0.25" (6 mm)

Housing	D	E
NEMA 1	4.70 (119)	5.00 (127)
TYPE 4X/7/9 Group B	5.93 (151)	3.87 (98)

Conduit Connections F
Electrical Switches
TYPE 4X/7/9: 1" NPT
Group B: 1" NPT
Pneumatic Switches
NEMA 1: ¼" NPT

① Min S.G. given is for single switch units with -1 materials of construction only. Consult factory for other configurations.

② Switch actuating levels (HL & LL) are given for minimum specific gravity materials of construction -1 and single switch units. Consult factory for other configurations.

NOTES:

1. Standard process connections are a combination of 1" NPT and 1" socket weld coupling.
2. Allow overhead clearance of 10 inches (254 mm) for cover removal.
3. All housings rotatable 360 degrees.

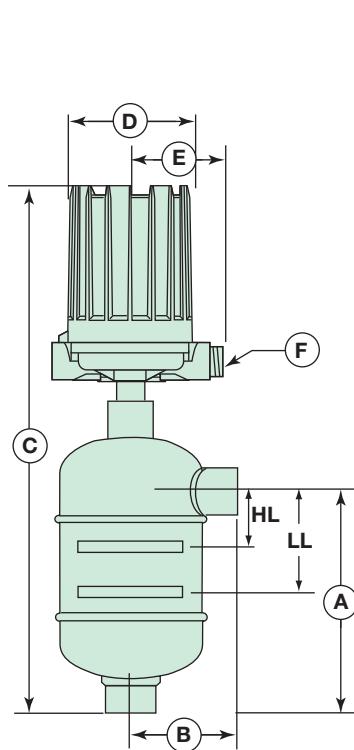

Series 75  
Threaded and Socket Weld  
Upper Side/Bottom

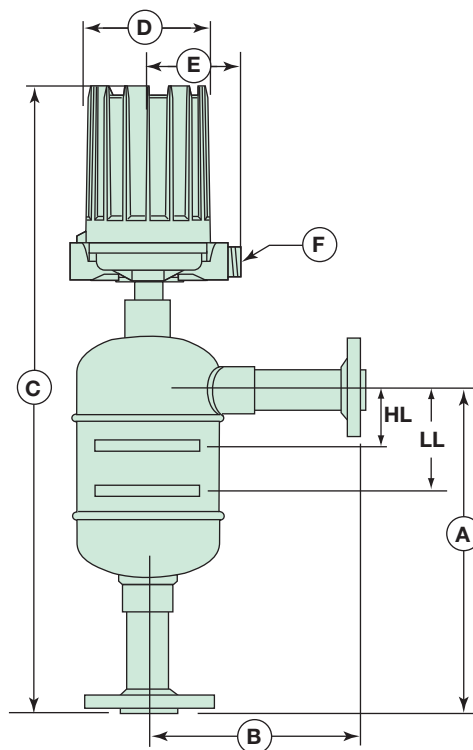

Series 75  
Flanged Upper Side/Bottom

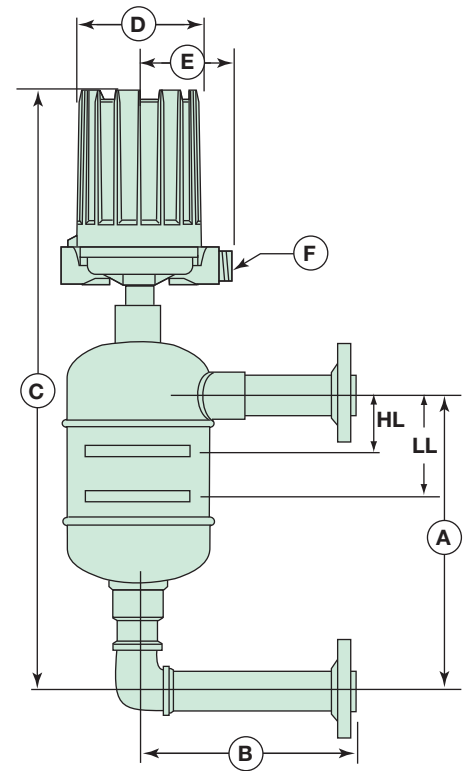

Series 75  
Flanged Side/Side

# DIMENSIONAL SPECIFICATIONS

## STAINLESS STEEL CHAMBERS WITH 1-INCH CONNECTIONS INCHES

## MILLIMETERS

	Min. SG <sup>①</sup>	NPT & Socket Weld			Flanged Upper Side/Btm			Flanged Side/Side			Actuating Levels <sup>②</sup>		NPT & Socket Weld			Flanged Upper Side/Btm			Flanged Side/Side			Actuating Levels <sup>②</sup>	
		A	B	C	A	B	C	A	B	C	HL	LL	A	B	C	A	B	C	A	B	C	HL	LL
B73	0.59	6.36	2.83	17.44	9.25	6.25	20.32	9.90	6.25	21.00	1.22	2.10	151	72	442	235	159	515	251	159	532	30	53
C75	0.60	8.50	3.61	22.06	11.56	6.68	25.12	12.21	6.68	25.75	2.75	3.62	216	92	560	294	170	638	310	170	654	70	92
J75	0.57	9.25	3.61	23.06	12.31	6.68	26.12	12.96	6.68	26.75	2.93	3.78	235	92	586	313	170	663	329	170	679	74	96
O75 <sup>③</sup>	0.85	8.50	2.71	21.87	11.56	5.68	24.93	12.21	5.68	25.62	2.44	3.50	216	69	555	294	144	633	310	144	651	62	89
O75 <sup>④</sup>	0.85	8.50	2.59	21.56	11.56	5.56	24.62	12.21	5.56	25.43	2.44	3.50	216	66	548	294	141	625	310	141	646	62	89
P75	0.75	8.50	3.09	21.93	11.56	6.12	25.00	12.21	6.12	25.68	2.56	3.50	216	76	557	294	155	635	310	155	652	65	89

Levels are ±0.25" (6 mm)

## CARBON STEEL CHAMBERS WITH 1-INCH CONNECTIONS INCHES

## MILLIMETERS

	Min. SG <sup>①</sup>	NPT & Socket Weld			Flanged Upper Side/Btm			Flanged Side/Side			Actuating Levels <sup>②</sup>		NPT & Socket Weld			Flanged Upper Side/Btm			Flanged Side/Side			Actuating Levels <sup>②</sup>	
		A	B	C	A	B	C	A	B	C	HL	LL	A	B	C	A	B	C	A	B	C	HL	LL
B73	0.59	6.36	3.34	17.44	9.25	6.25	20.32	9.90	6.25	21.00	1.22	2.10	151	84	442	235	159	515	251	159	532	30	53
B75	0.67	8.69	3.80	22.69	11.56	6.69	25.56	12.21	6.69	26.21	2.56	3.24	221	97	576	294	170	649	310	170	666	65	82
C75	0.55										2.72	3.44										69	87
F75	0.55	10.91	5.33	24.91	13.78	8.19	27.78	14.39	8.19	28.39	1.76	2.35	277	135	633	350	208	706	366	208	721	44	59
G75	0.53	9.44	4.33	23.44	12.31	7.19	26.31	12.96	7.19	26.96	2.25	2.92	240	110	595	313	183	668	329	183	685	57	74
J75	0.48										2.90	3.62										73	91
K75	0.39	11.69	5.33	25.69	14.56	8.19	28.56	15.21	8.19	29.21	2.15	2.77	297	135	653	370	208	754	386	208	742	54	70
L75	0.40	9.44	4.33	23.44	12.31	7.19	26.31	12.96	7.19	26.96	2.45	3.19	240	110	595	313	183	668	329	183	685	62	81
N75	0.32	11.69	5.33	25.69	14.56	8.19	28.56	15.21	8.19	29.21	2.17	2.86	297	135	653	370	208	754	386	208	742	55	72
S75	0.60	11.16	5.33	27.06	Consult Factory						2.13	2.78	283	135	687	Consult Factory						54	70
V75	0.74	9.02	4.15	23.27	11.56	6.68	25.81	12.21	6.68	26.46	2.63	3.38	229	105	591	294	170	656	313	170	672	69	86
Z75	0.68	9.77	4.68	24.16	12.31	7.18	26.70	12.96	7.18	27.35	2.38	3.19	248	119	614	313	182	678	329	182	695	60	81

Levels are ±0.25" (6 mm)

Housing	D	E
NEMA 1	4.70 (119)	5.00 (127)
TYPE 4X/7/9 Group B	5.93 (151)	3.87 (98)

Conduit Connections F
Electrical Switches
TYPE 4X/7/9: 1" NPT
Group B: 1" NPT
Pneumatic Switches
NEMA 1: ¼" NPT

- ① Min S.G. given is for single switch units with -1 materials of construction only. Consult factory for other configurations.
- ② Switch actuating levels (HL & LL) are given for minimum specific gravity materials of construction -1 and single switch units. Consult factory for other configurations.
- ③ 304 Stainless steel only.
- ④ 316 Stainless steel only.
- ⑤ These dimensions increase by 2.19 inches (55 mm) with Series HS switches with terminal blocks.

### NOTES:

1. Standard process connections are a combination of 1" NPT and 1" socket weld coupling.
2. Allow overhead clearance of 10 inches (254 mm) for cover removal.
3. All housings rotatable 360 degrees.

# DIMENSIONAL SPECIFICATIONS

INCHES (mm)

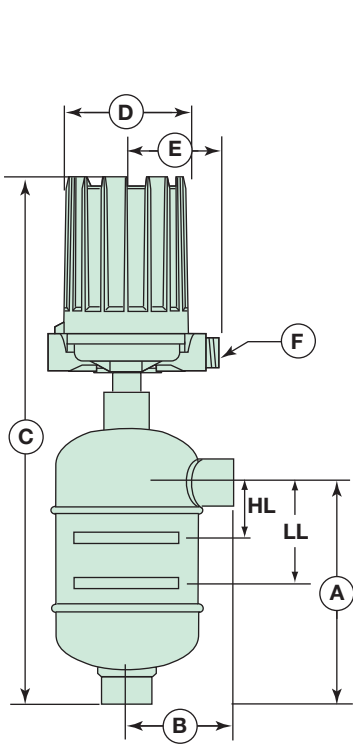

**Series 75**  
Threaded and Socket Weld  
Upper Side/Bottom

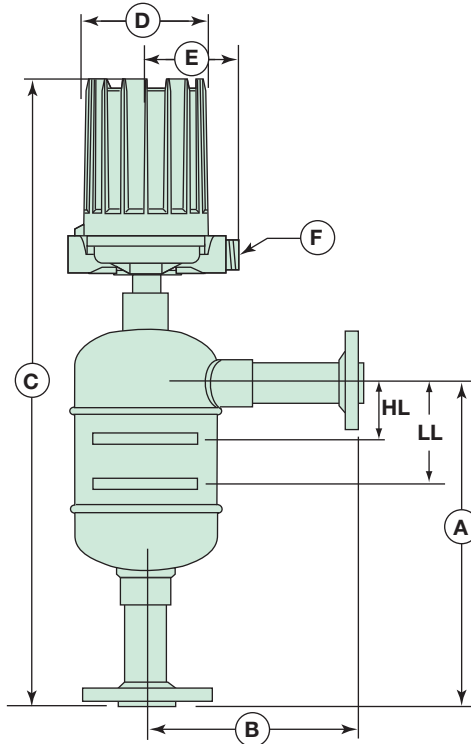

**Series 75**  
Flanged Upper Side/Bottom

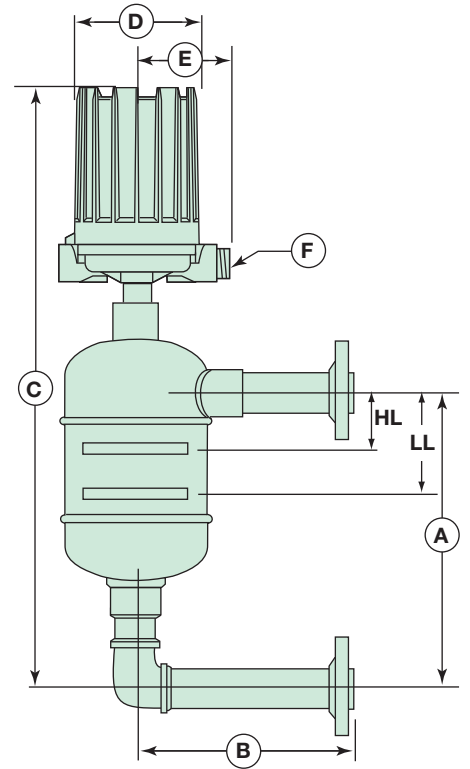

**Series 75**  
Flanged Side/Side

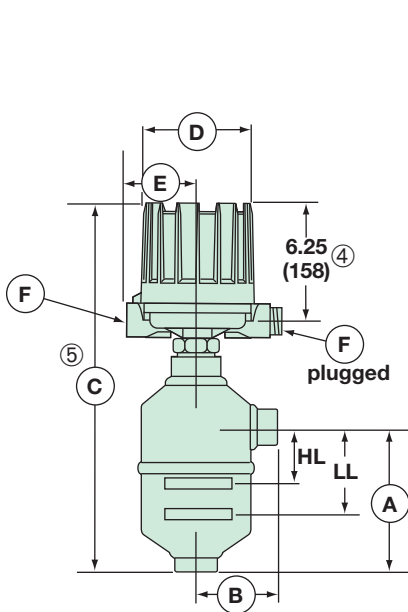

**Model B73**  
Threaded and Socket Weld  
Upper Side/Bottom

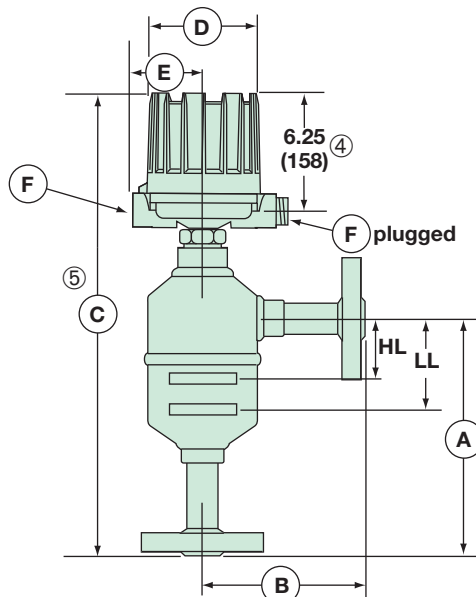

**Model B73**  
Flanged Upper Side/Bottom

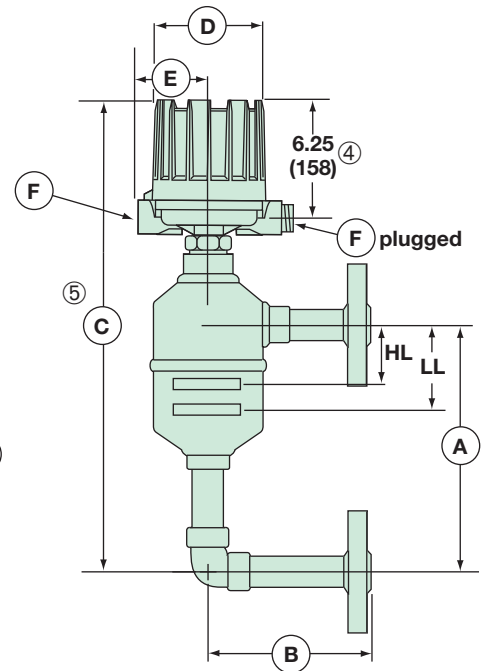

**Model B73**  
Flanged Side/Side

# MODEL NUMBER

## SERIES B73

Models available for quick shipment, usually within one week after factory receipt of a complete purchase order, through the Expedite Ship Plan (ESP)

### MODEL NUMBER CODE

Model No.	Min. SG	Materials of Construction	Pressure Rating			
			psig @ °F		bar @ °C	
			100	450 <sup>①</sup>	38	232 <sup>①</sup>
B73-1	0.59	Carbon steel chamber, 316 stainless steel float, 400 stainless steel trim	400	275	28	20
B73-2	0.59	Carbon steel chamber, 316 stainless steel float, 316 stainless steel trim				
B73-3	0.59	304 stainless steel chamber, 316 stainless steel float, 304 stainless steel trim				
B73-4	0.59	316 stainless steel chamber, 316 stainless steel float, 316 stainless steel trim				

### TANK CONNECTION TYPE AND SIZE

B20	1" NPT threaded side/bottom
B30	1" socket weld side/bottom
N30	1" 150 lb. flanged upper side/bottom
N40	1" 300 lb. flanged upper side/bottom
S30	1" 150 lb. flanged side/side
S40	1" 300 lb. flanged side/side

- ① Models are limited to maximum temperature rating of selected switch mechanism. See Switch Mechanism chart on page 9.
- ② Process temperature based on +100 °F (+38 °C) ambient.
- ③ On steam & other condensing applications, temperature down-rated to +400 °F (+204 °C) process @ +100° F (+38 °C) ambient.

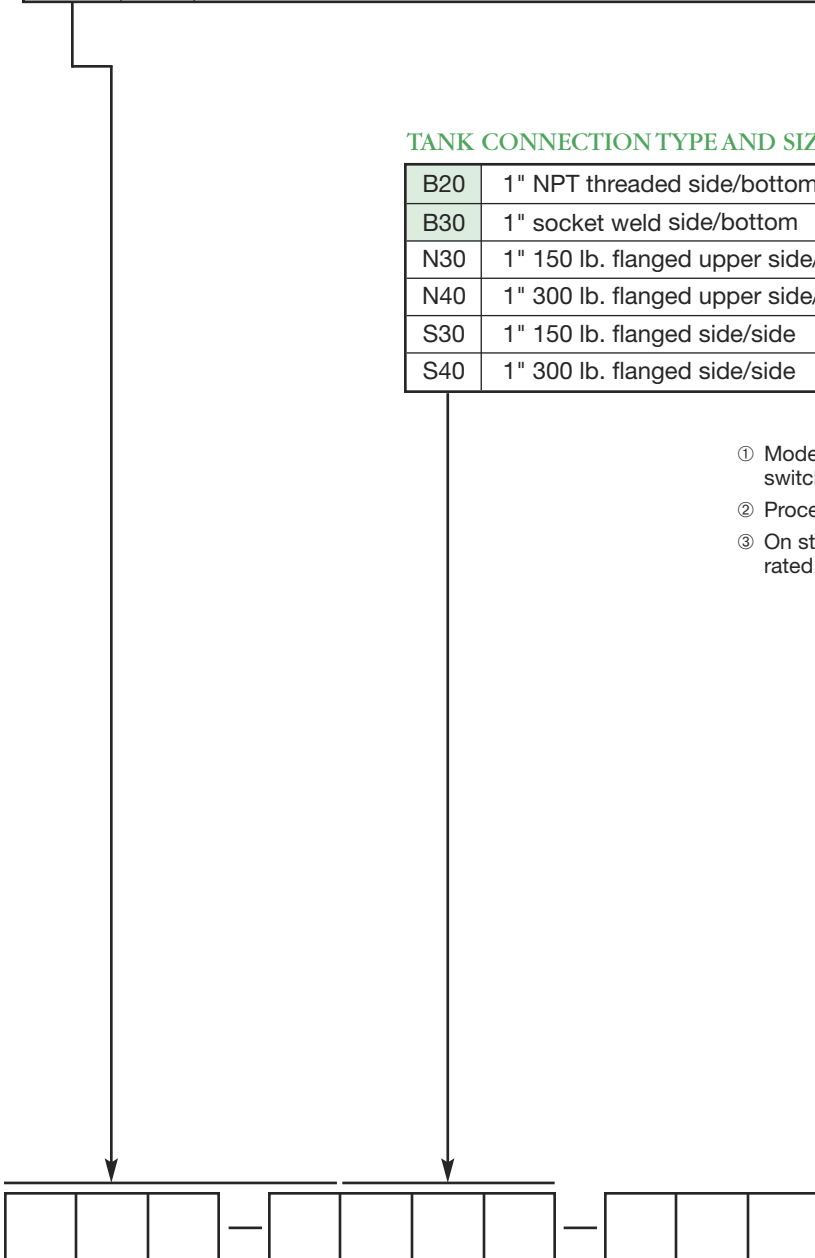

**ELECTRIC SWITCH MECHANISM AND ENCLOSURE**

Switch Description	② Process Temperature Range °F (°C)	One Set Point Contacts	Model B73-1 Only			Models B73-2, B73-3, B73-4		
			TYPE 4X/7/9 Aluminum Enclosure					
			Class I, Div 1 Groups C & D	Class I, Div 1 Groups B, C & D	Ⓢ II 2 G EEx D IIC T6	Class I, Div 1 Groups C & D	Class I, Div 1 Groups B, C & D	Ⓢ II 2 G EEx D IIC T6
Series B Snap	-40 to +250 (-40 to +121)	SPDT	BKP	BKT	BAC	BKQ	BKS	BA9
		DPDT	BNP	BNT	BBC	BNQ	BNS	BB9
Series C Snap	-40 to +450 (-40 to +232)	SPDT	CKP	CKT	CAC	CKQ	CKS	CA9
		DPDT	CNP	CNT	CBC	CNQ	CNS	CB9
Series D Snap	-40 to +250 (-40 to +121)	SPDT	n/a			DKQ	DKS	DA9
		DPDT	n/a			DNQ	DNS	DB9
Series F Hermetically Sealed Snap	-50 to +450 (-46 to +232)	SPDT	FKP	FKT	FAC	FKQ	FKS	FA9
		DPDT	FNP	FNT	FBC	FNQ	FNS	FB9
Series HS Hermetically Sealed 5 amp Snap with wiring leads	③ -50 to +450 (-46 to +232)	SPDT	n/a			HMC	HEK	n/a
		DPDT	n/a			HMF	HET	n/a
Series HS Hermetically Sealed 5 amp Snap with terminal block	③ -50 to +450 (-46 to +232)	SPDT	n/a			HM3	HM4	HA9
		DPDT	n/a			HM7	HM8	HB9

**PNEUMATIC SWITCH MECHANISM AND ENCLOSURE**

Switch Description	Maximum Supply Pressure		Maximum Process Temperature		Bleed Orifice Diameter		Models with Material of Construction	
	psig	bar	° F	° C	inches	mm	Code 1 NEMA 1	Code 2, 3 or 4 NEMA 1
Series J Bleed Type	100	7	400	204	.063	1.6	JDG	JDE
	60	4	400	204	.094	2.3	JEG	JEE
	60	4	450	232	.055	1.4	—	JFE
Series K Non-Bleed	100	7	400	204	—	—	—	KOE
	40	3	400	204	—	—	KOG	—

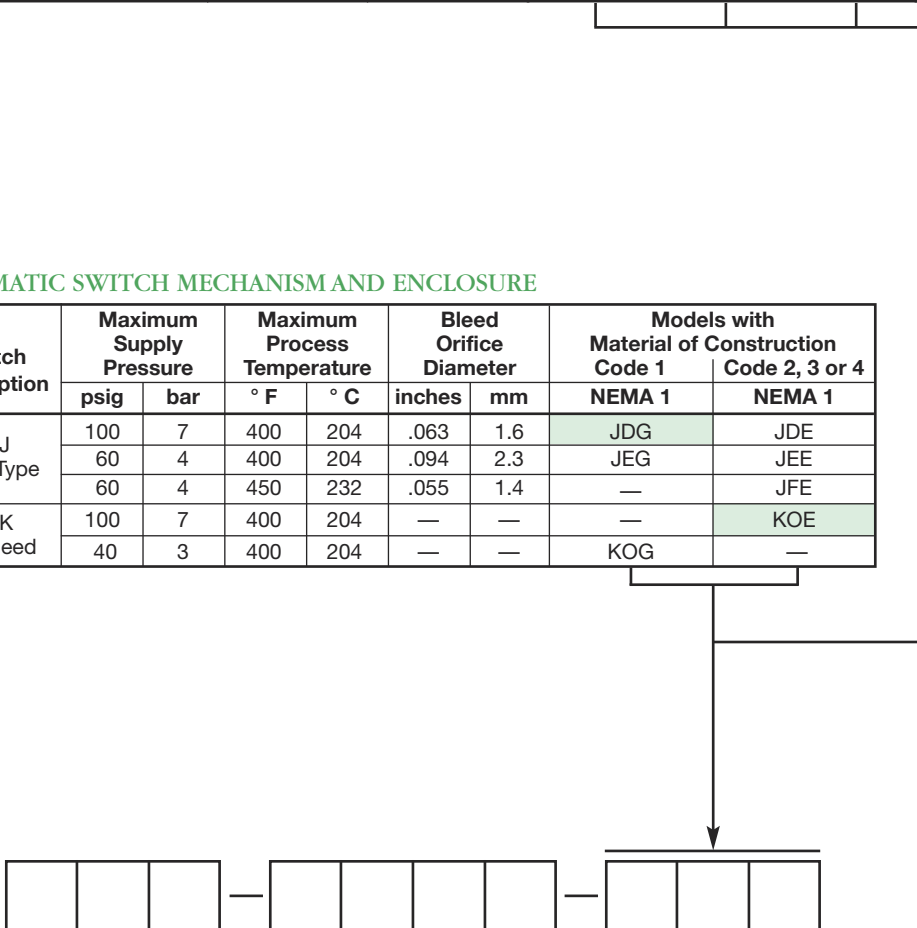

# MODEL NUMBER

## SERIES 75 with Carbon Steel Chamber



Models available for quick shipment, usually within one week after factory receipt of a complete purchase order, through the Expedite Ship Plan (ESP)

### MODEL NUMBER CODE

Model Code	Min. S.G. for models with ① Material of Construction Code			Pressure Rating ②									
				psig @ °F					bar @ °C				
	1	2		100	550	750	900 <sup>③</sup>	1000 <sup>③⑨</sup>	38	288	399	482 <sup>③</sup>	538 <sup>③⑨</sup>
B75	0.67	0.71		1000	870	716	357	138	69	60	49	25	10
C75	0.55	0.59		500	435	400	357	138	34	30	28	25	10
F75	0.55	0.56		1000	870	800	523	200	69	60	55	36	14
G75	0.53	0.56		750	653	600	338	130	52	45	41	23	9
J75	0.48	0.51		400	—	250	—	—	28	—	17	—	—
K75	0.39	0.40		600	—	375	—	—	41	—	26	—	—
L75	0.40	0.42		300	—	185	—	—	21	—	13	—	—
N75	0.32	0.33		450	—	280	—	—	31	—	19	—	—
S75 <sup>④</sup>	0.60	n/a		1500	1275	1045	523	n/a	103	88	72	36	n/a
V75 <sup>④</sup>	0.74	0.81		2240	1913	1455	728	n/a	154	132	100	50	n/a
Z75 <sup>④</sup>	0.68	0.71		2193	1913	1425	713	n/a	151	132	98	49	n/a

### MATERIALS OF CONSTRUCTION

1	Carbon steel chamber, 316 stainless steel float, 400 stainless steel trim
2	Carbon steel chamber, 316 stainless steel float, 316 stainless steel trim

### TANK CONNECTION TYPE AND SIZE

Type	Material	Size											
		1"				1½"				2"			
Threaded Side/Bottom	CS	B20				C20				D20			
Socket Weld Side/Bottom	CS	B30				C30				D30			
		Cage Mounting Flange Rating (lbs.)											
		150	300	600	900 <sup>⑤</sup>	150	300	600	900 <sup>⑤</sup>	150	300	600	900 <sup>⑤</sup>
Flanged Upper Side/Bottom	CS	N30	N40	N50	N60	P30	P40	P50	P60	Q30	Q40	Q50	Q60
Flanged Side/Side	CS	S30	S40	S50	S60	T30	T40	T50	T60	V30	V40	V50	V60

### PNEUMATIC SWITCH MECHANISM AND ENCLOSURE

Switch Description	Maximum Supply Pressure		Maximum Process Temperature		Bleed Orifice Diameter		Excluding S75, V75 & Z75	S75, V75 & Z75
	psig	bar	° F	° C	inches	mm	NEMA 1	NEMA 1
Series J Bleed Type	100	7	400	204	.063	1.6	JDE	JKE
	60	4	400	204	.094	2.3	JEE	JLE
	60	4	700	371	.055	1.3	JFE	JME
Series K Non-Bleed	100	7	400	204	—	—	KOE	KPE

① Minimum specific gravity ratings apply only to single stage units. Consult factory for two or three stage units.

② Models are limited to maximum temperature rating of selected switch mechanism. See Switch Mechanism Charts above.

③ Use caution when specifying carbon steel and stainless steel for temperatures greater than +800 °F (+427 °C), as they become sensitized.

④ S75, V75 & Z75 contain 17-7 ph float.

⑤ Valid for Models V75 & Z75 only.

⑥ Process temperature based on +100° F (+38 °C) ambient.

⑦ HS switches can be used with only materials of construction code 1 on models S75, V75 & Z75.

⑧ On steam and other condensing applications, temperature down-rated to +400 °F (+204 °C) process at +100 °F (+38 °C) ambient.

⑨ Consult factory for process temperatures up to +1200 °F (+650 °C)

See next page for **Electric Switch Mechanism and Enclosure** codes.





ELECTRIC SWITCH MECHANISM AND ENCLOSURE

Switch Description	Process <sup>®</sup> Temperature Range °F (°C)	Contacts	Set Points	All Models with Material of Construction Code 1 except Models S75, V75 & Z75			All models with Material of Construction Codes 2 and all Models S75, V75 & Z75		
				TYPE 4X/7/9 Aluminum Enclosure					
				Class I, Div 1 Groups C&D	Class I, Div 1 Group B	ATEX Ex II 2 G EEx d IIC T6	Class I, Div 1 Groups C&D	Class I, Div 1 Group B	ATEX Ex II 2 G EEx d IIC T6
Series B Snap Switch	-40 to +250 (-40 to +121)	SPDT	1	BKA	BKJ	BCC	BKB	BKK	BC9
			2	BLA	BLJ	BDC	BLB	BLK	BD9
			3	BMA	BMJ	BEC	BMB	BMK	BE9
		DPDT	1	BNA	BNJ	BFC	BNB	BNK	BF9
			2	BOA	BOJ	BGC	BOB	BOK	BG9
Series C Snap Switch	-40 to +450 (-40 to +232)	SPDT	1	CKA	CKJ	CCC	CKB	CKK	CC9
			2	CLA	CLJ	CDC	CLB	CLK	CD9
			3	CMA	CMJ	CEC	CMB	CMK	CE9
		DPDT	1	CNA	CNJ	CFC	CNB	CNK	CF9
			2	COA	COJ	CGC	COB	COK	CG9
Series D DC Current Snap Switch	-40 to +250 (-40 to +121)	SPDT	1	DKB	DKK	DC9	DKB	DKK	DC9
			2	DLB	DLK	DD9	DLB	DLK	DD9
			3	DMB	DMK	DE9	DMB	DMK	DE9
		DPDT	1	DNB	DNK	DF9	DNB	DNK	DF9
			2	DOB	DOK	DG9	DOB	DOK	DG9
Series F Hermetically Sealed Snap Switch	-50 to +750 (-46 to +399)	SPDT	1	FKA	FKJ	FCC	FKB	FKK	FC9
			2	FLA	FLJ	FDC	FLB	FLK	FD9
		DPDT	1	FNA	FNJ	FFC	FNB	FNK	FF9
			2	FOA	FOJ	FGC	FOB	FOK	FG9
Series HS <sup>⑦</sup> Hermetically Sealed 5-amp Snap Switch with Wiring Leads	-50 to +550 <sup>®</sup> (-46 to +288)	SPDT	1	HMJ	HMK	N/A	HMJ	HMK	N/A
			2	HMN	HMP		HMN	HMP	
		DPDT	1	HMS	HMT		HMS	HMT	
			2	HMY	HMZ		HMY	HMZ	
Series HS <sup>⑦</sup> Hermetically Sealed 5-amp Snap Switch with Terminal Block	-50 to +550 <sup>®</sup> (-46 to +288)	SPDT	1	HM3	HM4	HA9	HM3	HM4	HA9
		DPDT	1	HM7	HM8	HB9	HM7	HM8	HB9
Series R High Temperature Snap Switch	-40 to +750 (-40 to +399)	SPDT	1	RKB	RKK	RC9	RKB	RKK	RC9
			2	RLB	RLK	RD9	RLB	RLK	RD9
		DPDT	1	RNB	RNK	RF9	RNB	RNK	RF9
			2	ROB	ROK	RG9	ROB	ROK	RG9
Series 8 Hermetically Sealed Snap Switch	-50 to +750 (-46 to +399)	SPDT	1	8KA	8KJ	8CC	8KB	8KK	8C9
			2	8LA	8LJ	8DC	8LB	8LK	8D9
			3	8MA	8MJ	8EC	8MB	8MK	8E9
		DPDT	1	8NA	8NJ	8FC	8NB	8NK	8F9
			2	8OA	8OJ	8GC	8OB	8OK	8G9
Series 9 High Temperature Hermetically Sealed Snap Switch	-50 to +750 (-46 to +399)	SPDT	1	9KA	9KJ	9CC	9KB	9KK	9C9
			2	9LA	9LJ	9DC	9LB	9LK	9D9
			3	9MA	9MJ	9EC	9MB	9MK	9E9
		DPDT	1	9NA	9NJ	9FC	9NB	9NK	9F9
			2	9OA	9OJ	9GC	9OB	9OK	9G9
Switch Description	Process <sup>®</sup> Temp. Range °F (°C)	Contacts	Set Points	CS/Aluminum	Cast Iron		CS/Aluminum	Cast Iron	
				NEMA 4X	Class I, Div 1 Groups C&D	Class I, Div 1 Group B	NEMA 4X	Class I, Div 1 Groups C&D	Class I, Div 1 Group B
Series R High Temperature Snap Switch	-40 to +1000 (-40 to +538)	SPDT	1	R1M	RKM	RKW	R1M	RKM	RKW
			2	R3M	RLM	RLW	R3M	RLM	RLW
		DPDT	1	RDM	RNM	RNW	RDM	RNM	RNW
			2	REM	ROM	ROW	REM	ROM	ROW
Series 9 High Temperature Hermetically Sealed Snap Switch	-50 to +1000 (-46 to +538)	SPDT	1	9AD	9KD	9KV	9AM	9KM	9KW
			2	9BD	9LD	9LV	9BM	9LM	9LW
			3	9CD	9MD	9MV	9CM	9MM	9MW
		DPDT	1	9DD	9ND	9NV	9DM	9NM	9NW
			2	9ED	9OD	9OV	9EM	9OM	9OW

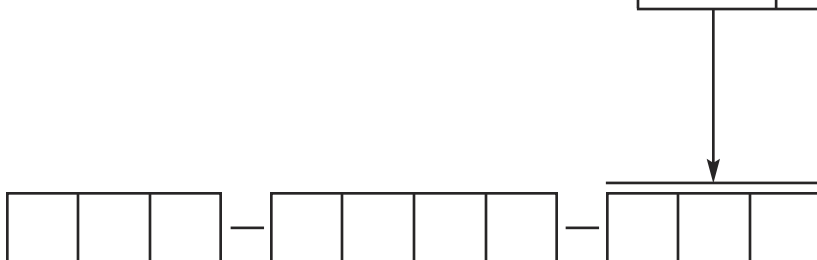

# MODEL NUMBER

## SERIES 75 with Stainless Steel Chamber

### MODEL NUMBER CODE

Model Code	Min. S.G. for models with <sup>①</sup> Material of Construction Code	Pressure Rating <sup>②</sup>									
		psig @ °F					bar @ °C				
		3 & 4	100	550	750	900 <sup>③</sup>	1000 <sup>③⑦</sup>	38	288	399	482 <sup>③</sup>
C75	0.60	500	435	400	385	380	34	30	28	26	26
J75	0.57	400	—	225	—	—	28	—	16	—	—
O75	0.85	500	435	400	385	380	34	30	28	26	26
P75	0.75	400	—	225	—	—	28	—	16	—	—

### MATERIALS OF CONSTRUCTION

3	304 Stainless steel chamber, 316 stainless steel float, 316 stainless steel trim
4	316 Stainless steel chamber, 316 stainless steel float, 316 stainless steel trim

### TANK CONNECTION TYPE AND SIZE

Type	Material	Size											
		1"		1½" <sup>④</sup>				2" <sup>④</sup>					
Threaded Side/Bottom	SS	B20		C20				D20					
Socket Weld Side/Bottom	SS	B30		C30				D30					
		Cage Mounting Flange Rating (lbs.)											
		150	300	600	900	150	300	600	900	150	300	600	900
Flanged Upper Side/Bottom	SS	N30	N40	Consult Factory									
Flanged Side/Side	SS	S30	S40	Consult Factory									

### PNEUMATIC SWITCH MECHANISM AND ENCLOSURE

Switch Description	Maximum Supply Pressure		Maximum Process Temperature		Bleed Orifice Diameter		NEMA 1
	psig	bar	°F	°C	inches	mm	
Series J Bleed Type	100	7	400	204	.063	1.6	JDE
	60	4	400	204	.094	2.3	JEE
	60	4	700	371	.055	1.3	JFE
Series K Non-Bleed	100	7	400	204	—	—	KOE

- ① Minimum specific gravity ratings apply only to single stage units. Consult factory for two or three stage units.
- ② Models are limited to maximum temperature rating of selected switch mechanism. See Switch Mechanism Charts above.
- ③ Use caution when specifying carbon steel and stainless steel for temperatures greater than +800 °F (+427 °C), as they become sensitized.
- ④ The O75 and P75 are not available with 1½" and 2" process connections.
- ⑤ Process temperature based on +100 °F (+38 °C) ambient.
- ⑥ On steam and other condensing applications, temperature down-rated to +400 °F (+204 °C) process at +100 °F (+38 °C) ambient.
- ⑦ Consult factory for process temperatures up to +1200 °F (+650 °C)



See next page for **Electric Switch Mechanism and Enclosure** codes.

**ELECTRIC SWITCH MECHANISM AND ENCLOSURE**

Switch Description	Process ⑤ Temperature Range °F (°C)	Contacts	Set Points	All models		
				TYPE 4X/7/9 Aluminum Enclosure		
				Class I, Div 1 Groups C&D	Class I, Div 1 Group B	ATEX Ex II 2 G EEx d IIC T6
Series B Snap Switch	-40 to +250 (-40 to +121)	SPDT	1	BKB	BKK	BC9
			2	BLB	BLK	BD9
			3	BMB	BMK	BE9
		DPDT	1	BNB	BNK	BF9
			2	BOB	BOK	BG9
Series C Snap Switch	-40 to +450 (-40 to +232)	SPDT	1	CKB	CKK	CC9
			2	CLB	CLK	CD9
			3	CMB	CMK	CE9
		DPDT	1	CNB	CNK	CF9
			2	COB	COK	CG9
Series D DC Current Snap Switch	-40 to +250 (-40 to +121)	SPDT	1	DKB	DKK	DC9
			2	DLB	DLK	DD9
			3	DMB	DMK	DE9
		DPDT	1	DNB	DNK	DF9
			2	DOB	DOK	DG9
Series F Hermetically Sealed Snap Switch	-50 to +750 (-46 to +399)	SPDT	1	FKB	FKK	FC9
			2	FLB	FLK	FD9
		DPDT	1	FNB	FNK	FF9
			2	FOB	FOK	FG9
Series HS Hermetically Sealed 5-amp Snap Switch with Wiring Leads	-50 to +550 ⑥ (-46 to +288)	SPDT	1	HMJ	HMK	N/A
			2	HMN	HMP	
		DPDT	1	HMS	HMT	
			2	HMY	HMZ	
Series HS Hermetically Sealed 5-amp Snap Switch with Terminal Block	-50 to +550 ⑥ (-46 to +288)	SPDT	1	HM3	HM4	HA9
		DPDT	1	HM7	HM8	HB9
Series R High Temperature Snap Switch	-40 to +750 (-40 to +399)	SPDT	1	RKB	RKK	RC9
			2	RLB	RLK	RD9
		DPDT	1	RNB	RNK	RF9
			2	ROB	ROK	RG9
Series 8 Hermetically Sealed Snap Switch	-50 to +750 (-46 to +399)	SPDT	1	8KB	8KK	8C9
			2	8LB	8LK	8D9
			3	8MB	8MK	8E9
		DPDT	1	8NB	8NK	8F9
			2	8OB	8OK	8G9
Series 9 High Temperature Hermetically Sealed Snap Switch	-50 to +750 (-46 to +399)	SPDT	1	9KB	9KK	9C9
			2	9LB	9LK	9D9
			3	9MB	9MK	9E9
		DPDT	1	9NB	9NK	9F9
			2	9OB	9OK	9G9
Switch Description	Process ⑤ Temp. Range °F (°C)	Contacts	Set Points	CS/Aluminum	Cast Iron	
				NEMA 4X	Class I, Div 1 Groups C&D	Class I, Div 1 Group B
Series R High Temperature Snap Switch	-40 to +1000 (-40 to +538)	SPDT	1	R1M	RKM	RKW
			2	R3M	RLM	RLW
		DPDT	1	RDM	RNM	RNW
			2	REM	ROM	ROW
Series 9 High Temperature Hermetically Sealed Snap Switch	-50 to +1000 (-46 to +538)	SPDT	1	9AM	9KM	9KW
			2	9BM	9LM	9LW
			3	9CM	9MM	9MW
		DPDT	1	9DM	9NM	9NW
			2	9EM	9OM	9OW

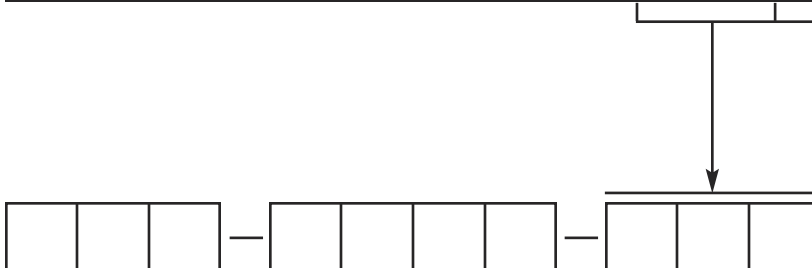

## QUALITY

---



The quality assurance system in place at Magnetrol® guarantees the highest level of quality throughout the company. MAGNETROL is committed to providing full customer satisfaction both in quality products and quality service.

The MAGNETROL quality assurance system is registered to ISO 9001 affirming its commitment to known international quality standards providing the strongest assurance of product/service quality available.

## ESP

---

### Expedite Ship Plan

Several Sealed External Cage Level Switches are available for quick shipment, usually within one week after factory receipt of a complete purchase order, through the Expedite Ship Plan (ESP).

To take advantage of ESP, match the color coded model number codes in the selection charts (standard dimensions apply).

ESP service may not apply to orders of ten units or more. Contact your local representative for lead times on larger volume orders, as well as other products and options.

## WARRANTY

---



All MAGNETROL mechanical level and flow controls are warranted free of defects in materials or workmanship for five full years from the date of original factory shipment.

If returned within the warranty period; and, upon factory inspection of the control, the cause of the claim is determined to be covered under the warranty; then, MAGNETROL will repair or replace the control at no cost to the purchaser

(or owner) other than transportation.

MAGNETROL shall not be liable for misapplication, labor claims, direct or consequential damage or expense arising from the installation or use of equipment. There are no other warranties expressed or implied, except special written warranties covering some MAGNETROL products.



705 Enterprise Street • Aurora, Illinois 60504-8149 • 630-969-4000  
info@magnetrol.com • www.magnetrol.com

Copyright © 2017 Magnetrol International, Incorporated.  
Performance specifications are effective with date of issue and are subject to change without notice.

Magnetrol & Magnetrol logotype are registered trademarks of Magnetrol International.

**BULLETIN: 46-115.28**  
**EFFECTIVE: July 2017**  
**SUPERSEDES: March 2016**