



Experience high performance  
across a broad range of  
applications.

**Fisher™ Vee-Ball™ Rotary Control Valves**  
Highly efficient rotary valves to meet a variety of application requirements.



## Fisher Vee-Ball Rotary Control Valves



With Emerson, you'll have the support of a global company with extensive international engineering, research, sales, marketing, manufacturing, and service operations. This means you'll have access to leading control valve and instrument technologies that offer new levels of performance and reliability. Regardless of your industry. And regardless of your location.

**FISHER™**

**If you can't count on your control valves, you can't count on your process. That's why operations like yours have chosen Fisher final control elements. Emerson provides trusted and tested products, along with local and certified support, so you can focus on meeting your production goals.** The precision-machined parts and pressure-balanced seals in the Vee-Ball valve designs allow smooth, precise valve operation across almost any application.

Actuators • Bulk Storage & Transport Equipment • **Control Valves** • Controllers & Instruments  
Flame & Detonation Arrestors • Industrial Heat Tracing • Isolation & Shut-off Valves • Nuclear Flow Controls  
Regulators & Relief Valves • Solenoid Valves • Tank Vents & Hatches

The Vee-Ball valve combines the best of Emerson application experience with the latest in control valve technology.

It offers a broad range of application versatility and can be coupled with Fisher actuators and FIELDVUE™ digital valve controllers to yield compact, easy-to-handle control valve packages. All components work together, delivering superior dynamic performance and low operating cost.



### Easy Installation

To reduce installation time and headaches, the Vee-Ball valve is available with either a flangeless ANSI body or an integral flange body. The flangeless design uses built-in centering lugs to help simplify alignment procedures.



### V-Notch Ball

The Vee-Ball valve with its V-notch ball provides positive shearing action and a nearly equal percentage flow characteristic. It provides non-clogging, high-capacity flow control of gas, steam, clean and dirty fluids, abrasive chemicals, and fibrous slurries. You will find this valve hard at work in pulp and paper, power, chemical, and petrochemical industries.

## Added-Value Features



**Minimal Deadband** A taper key ball-to-shaft connection eliminates lost motion and minimizes deadband. During maintenance procedures, this arrangement proves to be more reliable and easier to assemble than conventional connections.



**Heavy-Duty (HD) Seal** The heavy-duty ball seal offers exceptional wear and pressure drop performance over a wide range of steam, gas, liquid, and slurry applications. The metal seal is pressure-balanced, which reduces operating torques and allows higher pressure drops without excessive wear.



**Easy Seal Replacement and Inspection** Once the valve is removed from the pipeline, just remove two screws and the seal assembly is easily extracted from the body. No need to disassemble the valve body or remove the actuator. Metal and soft seals are fully interchangeable.



**Trim Interchangeability** Across the Vee-Ball line, size-for-size, trim components remain the same regardless of body style. This reduces parts inventory requirements and costs. It also simplifies maintenance training and procedures.

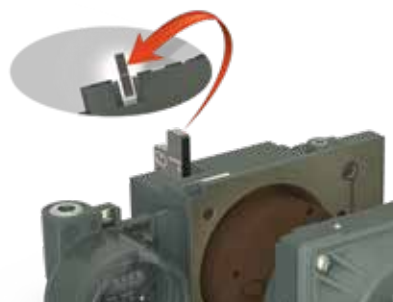

**Better Linkage Protection** Integral mounting of the positioner protects linkages. With no sliding parts to wear, loosen, corrode, or vibrate, a magnet array and Hall Effect sensor are used to detect valve position. This technology provides a robust solution for harsh environments and nonstop cycling.

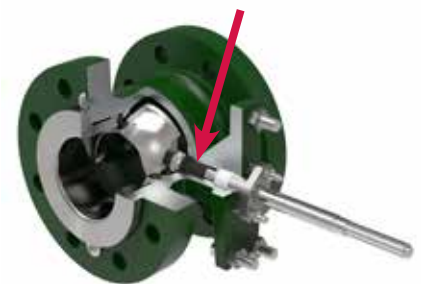

**Superior Bearings** To enhance the performance and service life of the valve, a patented, low-friction, high-load bearing system fully supports both drive and follower shafts. To reduce maintenance costs, this bearing system is designed to easily drop into place.



**Characterized V-Notch Ball Design**

The V-notch ball provides positive shearing action for fibrous flows and creates an inherently equal percentage flow characteristic. It has been specially contoured to maximize capacity and enhance seal life and shutoff integrity. The Vee-Ball valve offers high capacity with its unrestricted, straight-through flow path. The result is accurate throttling control over a wide range of flow conditions.



**Micro- Notch** balls allow extremely small flow rates. Available in ceramic, R30006, and chrome-plated CG8M SST.



**Cavitrol™ Hex** design is ideal for severe service liquid applications, helps reduce noise and cavitation effects that cause pipeline vibration.



**Rotary attenuator** reduces liquid cavitation damage and aerodynamic noise.

## Added-Value Features

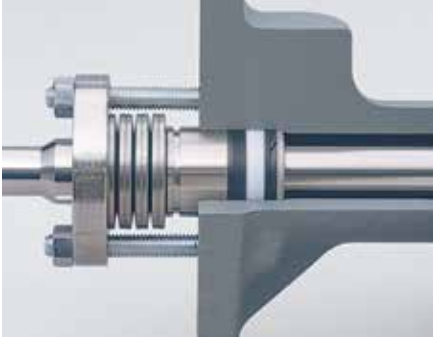

**Shaft Packing Options** A choice of shaft packing systems provides enhanced shaft sealing to meet specific application requirements. ENVIRO-SEAL™ packing is available in all Vee-Ball valves and helps meet stringent emission control requirements.



**Structural Integrity** The one-piece body improves structural integrity of the pressure boundary by eliminating the potential leak paths found in two-piece, bolted valve designs.



**Accurate Positioning** A splined driveshaft coupled with clamped actuator lever helps ensure zero lost motion.



**Process Compatibility** A wide choice of materials for the valve body, the V-notch ball, ball seals, shafts, and other components allows you to specify a Vee-Ball valve to meet most process applications.



**Erosive Slurry Control** The V150S Slurry Vee-Ball valve has a body liner, V-notch ball, and flow ring, all constructed of high-chromium iron. A ceramic flow ring insert is available for especially aggressive slurry services. V150S erosion-resistant trim components protect the body from erosive wear and are retained without the use of press fits or threads for easy replacement.



**Medium Consistency Pulping** The V150E expanded outlet Vee-Ball valve accommodates expanded downstream piping. The V150E outlet flange is one standard line size diameter larger than the inlet. The expanded outlet geometry streamlines the flow through the valve as the flow area increases from inlet to outlet.

## Choose the Actuator and Accessories to Fit the Control Situation

A choice of Fisher pneumatically-operated rotary actuators makes it easy to specify the right Vee-Ball control valve package for each application. The rotary actuators, available in spring-and-diaphragm and piston styles, share design and construction features that enable efficient and stable valve operation, even under application extremes.



- All actuator/positioner/valve linkages are enclosed for both personnel safety and protection against damage.
- Actuator housings are rugged to meet repeated, high-torque requirements.
- Splined-and-clamped valve shaft lever, plus a single-point actuator rod connection, minimize lost motion for maximum throttling control accuracy.
- A selection of actuator sizes allows matching actuator output to operating torque requirements.
- Corrosion-resistant powder coat paint and corrosion-resistant fasteners are standard.
- Optional declutchable manual operators will override the actuator to position the valve.

## For Even Greater Versatility, FIELDVUE Digital Valve Controllers

While a traditional valve positioner serves a single purpose—to maintain a valve in its intended control position—FIELDVUE digital valve controllers provide much more. FIELDVUE instrumentation collects real-time data about valve performance, which is crucial not only to reducing process variability but also to enhancing plant operations.

Designed for the Plantweb™ digital ecosystem, FIELDVUE digital valve controllers and ValveLink™ software enable you to run your operation more efficiently, safely, and profitably by delivering new insights on valve health.

## Money and Time-Saving Benefits

Regardless of the application, incorporating the Vee-Ball valve into your process can have significant money and time-saving benefits. In addition to providing top quality, expertly engineered valves, Emerson is committed to providing you with exceptional customer service. Emerson's application assistance, responsive replacement parts service, control valve repair, and training add even more value to the Vee-Ball rotary control valve.

### Improve Total Cost of Ownership



Quality construction enables long-term performance from your Vee-Ball valve.

### Reduce Process Variability



Extensive flow loop testing has demonstrated the Vee-Ball valve's low friction performance advantage in controlling process variability.

### Increase Reliability



The rugged Vee-Ball valve incorporates large margins of safety in its design. This, coupled with extensive flow testing and evaluation, results in a rotary control valve that is the industry standard for reliability.

### Enhance Operational Efficiency



The Vee-Ball valve's high capacity and excellent characteristics mean your process can be controlled with less system pressure drop across the control valve.





### Demonstrated Performance

Vee-Ball control valves undergo extensive testing for proof of performance. The dynamic performance lab enables thorough product testing and analysis with a simulated control loop to imitate actual process conditions.

## Simplify Parts Inventory



Commonality of parts across the Vee-Ball line helps you trim inventory costs to a minimum, resulting in bottom-line savings.

## Streamline Maintenance



The V-notch ball seal can be replaced without valve disassembly or actuator removal.

# Vee-Ball Valve Selection Guide



Flanged body design with a Class 150, 300, or 600 rating.



Flangeless body provides a multi-class rating.

## Availability Overview

Valve Design	End Connection	Size NPS/DN	Rating ANSI <sup>(1)</sup>
V150	Flanged	1 to 20	CL150
		DN 80 to 150	PN10 to 16
		DN 200 to 300	PN10 or 16
V200	Flangeless	1 to 2	CL150, 300, 600
		3 to 4	CL150, 300, 600
		6 to 8	CL150, 300, 600
		10	CL150
		Flanged	2 to 8
V300	Flanged	1 to 20	CL300
		DN 25 to 50	PN10 to 40
		DN 80 to 150	PN25 to 40
		DN 200 to 300	PN25 or 40

(1) ASME/ANSI B 16.34 Class Rating

(2) All Fisher Vee-Ball valves have a modified equal percentage flow characteristic and a flow coefficient ratio of 300:1.

## Vee-Ball Capacity

Size NPS	C <sub>v</sub> with Ball Wide Open V150, V200, V300 <sup>(1)</sup>	(90° Rotation) V150S
1	34	
1½	76	
2	123	
3	364	170
4	523	380
6	1080	705
8	1750	1150
10	2710	2200
12	4100	2850
14	5610	
16	8270	
20	10,300	

(1) C<sub>v</sub> values shown are for a construction containing the Fisher TCM Plus seal.

## Seal Overview

Vee-Ball Seal Constructions	Temperature Range	Shutoff Classification per ANSI/ASFCI 70-2 and IEC 60534-4
Flow Ring	-325 to 800°F	5% of max rated flow (bi-directional)
Flat Metal	-325 to 800°F	Class IV (forward flow)
TCM Plus/Ultra	-50 to 450°/500°F	Class VI (forward flow)
Heavy-Duty (HD)	-50 to 550°F	Class IV (bi-directional)
HD - High Temperature	-50 to 800°F	Class III (bi-directional)



Vee-Ball seal types shown include Flat Metal, TCM (composition), and HD.

# The Service and Support You Need

## Lifecycle Services



Emerson Lifecycle Services provide you with expertise, technology, and processes that can help your plant operate safely, improve asset reliability, and optimize process capabilities. Maintenance services keep your plant operating safely, consistently, and economically. Reliability services improve your asset integrity and preserve your investments. Performance services optimize your plant efficiency and help you achieve business goals.

## Educational Services







Emerson Educational Services provide your workforce with a full range of training options from certified instructors. Train new hires, improve your current workforce skills, or help your team adapt to new technology or products. Courses are offered through our regional training centers, locally or at your facility, via the web utilizing eLearning or virtual classroom, or through a blended learning approach.

Superior dynamic performance and low operating cost.



**FISHER™**

**Emerson Automation Solutions  
Flow Controls**  
Marshalltown, Iowa, 50158 USA  
Sorocaba, 18087 Brazil  
Cernay, 68700 France  
Dubai, United Arab Emirates  
Singapore 128461 Singapore

-  [Fisher.com](http://Fisher.com)
-  [Facebook.com/FisherValves](https://Facebook.com/FisherValves)
-  [LinkedIn.com/groups/Fisher-3941826](https://LinkedIn.com/groups/Fisher-3941826)
-  [Twitter.com/FisherValves](https://Twitter.com/FisherValves)

© 2018 Fisher Controls International LLC. All rights reserved. Fisher, Vee-Ball, FIELDVUE, ENVIRO-SEAL, Plantweb, and ValveLink are marks owned by one of the companies in the Emerson Automation Solutions business unit of Emerson Electric Co. Emerson, and the Emerson logo are trademarks and service marks of Emerson Electric Co. All other marks are the property of their respective owners. The contents of this publication are presented for informational purposes only, and while every effort has been made to ensure their accuracy, nothing herein is to be construed as a warranty or guarantee, express or implied, regarding the products or services described herein or their use, performance, merchantability or fitness for a particular purpose. Individual results may vary. All sales are governed by our terms and conditions, which are available upon request. We reserve the right to modify or improve the designs or specifications of our products at any time without notice. Responsibility for proper selection, use and maintenance of any product or service remains solely with the purchaser and end user. D350004X012 / MDD10 / May18



**EMERSON. CONSIDER IT SOLVED.™**