

Sentronic^{LP}

Digital Electronic Pressure Regulator
617 Series with Display and Controls

Installation Manual

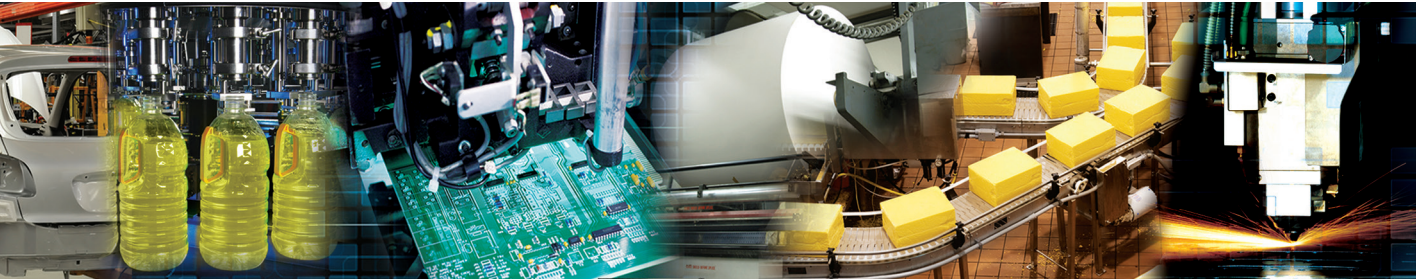

www.asco.com



Table of Contents

Sentronic^{LP}

Description	2
How To Order	2
Operating Elements	3
Manual Pressure Adjustment	3
Operating Modes	3
Electrical Connection	4
Analog Target Value - Output Pressure	5
Pneumatic Connection	6
Information on the Factory Settings	6
Technical Characteristics	7
Fluid Characteristics	7
Key Values	7
Care and Maintenance	8
Dimensions and Weights	9



CAUTION
OBSERVE PRECAUTIONS
FOR HANDLING
ELECTROSTATIC SENSITIVE
DEVICES

This product contains electronic components sensitive to electrostatic discharge. An electrostatic discharge generated by a person or object coming in contact with the electrical components can damage or destroy the product.

To avoid the risk of electrostatic discharge, please observe the handling precautions and recommendations contained in standard EN 100015-1. Do not connect or disconnect the device while it is energised.



CAUTION! Dangerous operating conditions may occur when using the programming interface on the valve as the valve may possibly not react to the analog setpoint any more. Provide for protection against uncontrolled movement of equipment when putting the valve into operation and before making any modifications to the valve settings.

We herewith declare that the version of the product described in this installation manual is intended to be incorporated into or assembled with other machinery and that it must not be put into service until the machinery into which it is to be incorporated has been declared in conformity with the provisions of Council Directive 2006/42/EC.

Handling, assembly and putting into service and all settings and adjustments must be done by qualified, authorised personnel only.



This product complies with the essential requirements of the EMC Directive 2014/30/EU and its amendments. It is CE-approved. A separate Declaration of Conformity is available on request. Please provide ordering code and serial numbers of products concerned.

NOTICE

The information in this manual is subject to change without notice.

In no event shall ASCO NUMATICS be liable for technical or editorial errors or omissions. Neither is any liability assumed for accidental or consequential damages arising out of or in connection with the supply or use of the information contained herein.

THIS MANUAL CONTAINS INFORMATION PROTECTED BY COPYRIGHT. NO PART OF THIS DOCUMENT MAY BE PHOTOCOPIED OR REPRODUCED IN ANY FORM OR MANNER WHATSOEVER WITHOUT PRIOR WRITTEN PERMISSION FROM ASCO NUMATICS.

Description

The Sentronic^{LP} valve operates with pulsed pilot valves which change the pressure in a control chamber. A downstream flow amplifier (pressure booster) converts the control pressure into an output pressure. The output pressure is measured by a pressure sensor and fed to the integrated digital control circuit. The target value is set via the electrical plug connection as a standard signal [0 to 10 V or 0(4) to 20 mA].

Sentronic^{LP} is particularly suitable for pressure control procedures where a constant pressure is required with different flow rates, such as air dosing via nozzles or turbine rotation speed control.

Using the available DaS software (Data Acquisition Software), the valve can be adapted to the application if necessary.

- The pressure connections and the air vent connections are designed in the same size, which results in short response times both for increasing the pressure and for reducing the pressure.
- Digital pressure control in a closed circuit: An internal pressure sensor measures the output pressure. The output pressure is adjusted in real time.
- The control parameters can be changed with the additional DaS software. The variability of the parameters used by the valve is ensured by the DaS software. This flexibility makes it possible to adapt the valve to a very wide range of applications and to optimize the response time and the precision of the valve and prevent it from overshooting.
- After determining the optimum parameters, these can be saved for personal use in a project file, which can be sent into our Product Support Department for future series production.

How to Order

8 617 A 4 2 2 1 0 A00 PB

<p>Threaded Connection</p> <p>G = ISO 228 (BSPP) 8 = NPT</p> <p>Product Series</p> <p>617</p> <p>Revision</p> <p>A = Initial release</p> <p>Size</p> <p>0 = Manifold Version + pressure hold (DN4)¹ 4 = 1/4 + pressure hold (DN4) 6 = 3/8 + pressure hold (DN8) 8 = 1/2 + pressure hold (DN15)</p> <p>Setpoint</p> <p>0 = 0 – 10 V 1 = 0 – 20 mA 2 = 4 – 20 mA 5 = 2 Bit, 4 pressure select</p> <p>¹ See Accessories for individual subbases for this Manifold Version ² No Digital In possible</p>	<p>Pressure Range</p> <table border="0"> <tr> <td></td> <td style="text-align: right;">Max. Inlet Pressure</td> </tr> <tr> <td>PA = 0 – 50 psi</td> <td style="text-align: right;">90 psi</td> </tr> <tr> <td>PB = 0 – 100 psi</td> <td style="text-align: right;">140 psi</td> </tr> <tr> <td>PC = 0 – 150 psi</td> <td style="text-align: right;">190 psi</td> </tr> </table> <p>Options</p> <p>A00 = Standard A07 = Oxygen clean</p> <p>Input/Display w/Buttons</p> <p>0 = Standard not connected + Display 1 = Standard not connected 8 = Digital IN + Display</p> <p>Output 2</p> <p>0 = Not connected 1 = Digital OUT² (Standard)</p> <p>FeedbackType</p> <p>0 = 0 – 10 V 1 = 0 – 20 mA 2 = 4 – 20 mA 7 = 2 Bit, 4 pressure select</p>		Max. Inlet Pressure	PA = 0 – 50 psi	90 psi	PB = 0 – 100 psi	140 psi	PC = 0 – 150 psi	190 psi
	Max. Inlet Pressure								
PA = 0 – 50 psi	90 psi								
PB = 0 – 100 psi	140 psi								
PC = 0 – 150 psi	190 psi								

Operating Elements



- 1 Power supply, M12 plug
- 2 Pressure output
- 3 Protective ground - M4 connector
- 4 Exhaust
- 5 Pressure supply
- 6 LC display
- 7 Control keys
- 8 Mounting hole

Manual Pressure Adjustment

(Manual Operation - Only for version with a display)

If the supply voltage is cut off, after a reconnection of the supply voltage and by pressing the two arrow keys below the display at the same time, the pressure regulator will change to “Manual operation” mode. This operating mode is indicated in the display by the letters “HND”.

The letters “HND” in the display will disappear after the arrow keys are released. The output pressure is shown on the display, followed by the letters “HND” at the top right of the display.

Using the arrow keys, the output pressure can be changed (left arrow key or arrow pointing down => reduce the output pressure, right arrow key or arrow pointing up => increase the output pressure).

This operating mode can be exited by pressing both arrow keys at the same time or by briefly cutting off the supply voltage.

Operating Modes

Shutoff:

If the setpoint is set to less than 0.5%, the air will be released from the valve and the current supplied to the exhaust valve will be switched off after 10 seconds.

Over temperature:

If the internal control electronics reach a temperature above 100°C, the control function will be restricted in order to prevent any more overheating.

Electrical Connection

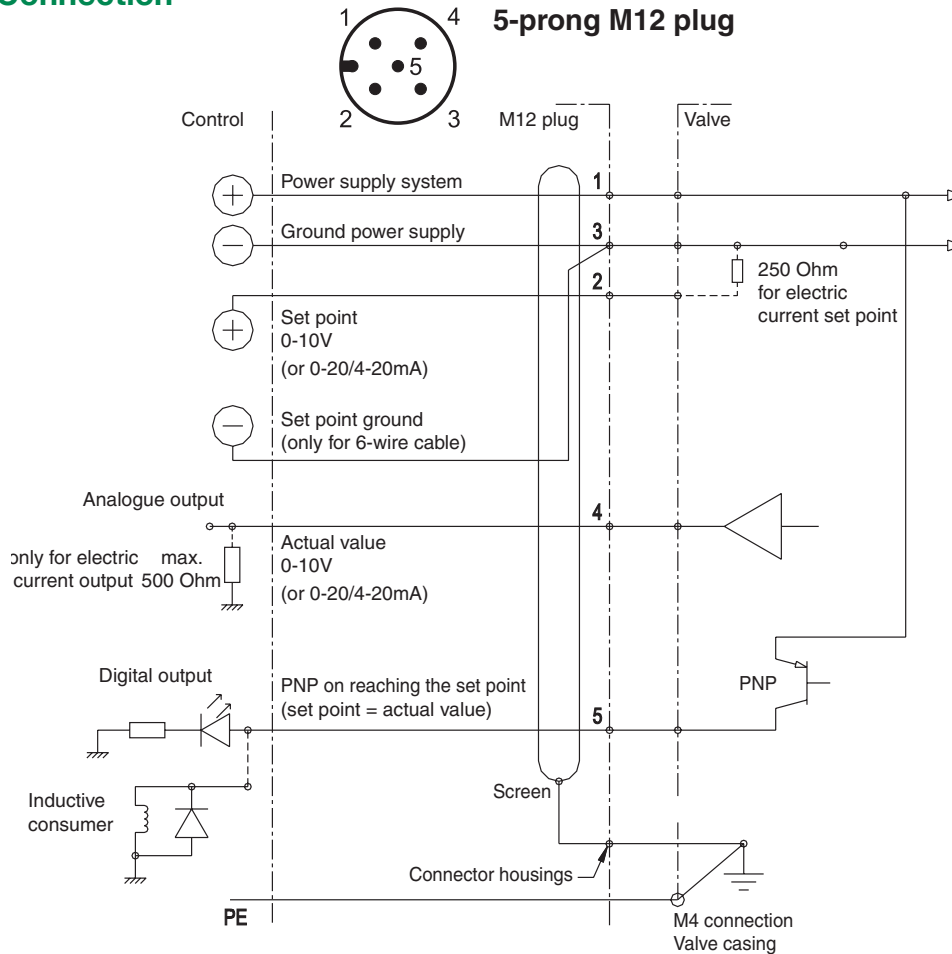

1. The valve may only be operated with a supply voltage of 24 VDC $\pm 10\%$ and a maximum ripple effect of 10%. (no supply via diode bridge). Overvoltages or ripple currents exceeding these tolerance limits may result in damage to the electronics of the pressure regulator.
2. The maximum current for the pressure switch is 200 mA / 4.8 W (PNP output). The output is protected against short circuits and overloads.
3. If a relay (inductive load) is connected to the pressure switch output, a free-wheeling diode or a varistor should be used.
4. To protect against electromagnetic interference, a shielded cable must be used.
5. The valve body must be grounded using the grounding terminal (diameter M4).

Connector Pinning/Cable Wiring

Standard Analog Control

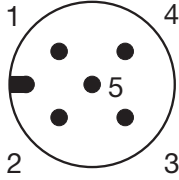

View from soldering side

Pin	Description	6-wire cable
1	24 VDC voltage supply	brown
2	Analog Setpoint Input	white
3	Supply common	blue
	Analog common*	yellow
4	Analog output (feedback)	black
5	Digital Output (pressure switch)	gray
Body	EMC screen	shield

* A 6-wire cable with separate common for the command signal is used for cable lengths over 2m to minimize the voltage drop for the command signal

2 Bit, 4 Pressure Select

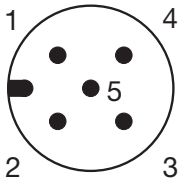

Pin	Description
1	24 VDC voltage supply
2	Input signal 1 (LSB)
3	Supply common
4	Input signal 2 (MSB)
5	Unused

2 Bit, 4 Pressure Select

How to Set Pressures

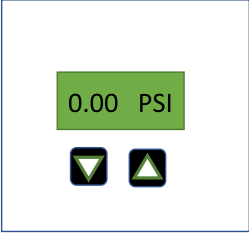
1. 

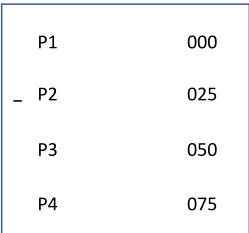
 Press & Hold Arrow Down Key, then press Arrow Up to enter the pressure select menu
2. 

Press arrow Down Key to select a setpoint to adjust

 (x2) (selects Setpoint 2)

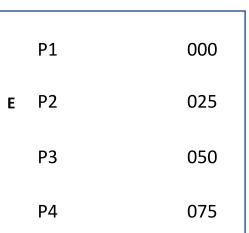
_ = Selected
3. 

 Press Arrow Up key once to enter Edit Mode (x1)

 Now Press Up or Down Key to adjust selected setpoint in 1 PSI Increments

Press & hold Up or Down Key to scroll continuously to a new setpoint value

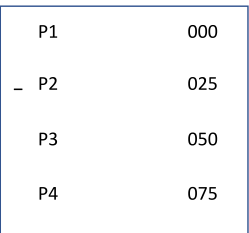
E = Edit
4. 

 Press & Hold Arrow Down Key, then press Arrow Up to exit Edit Mode (hold (x1))

 Press Arrow Down Key to move _ to a new setpoint & repeat Edit process (by pressing Arrow Up key)

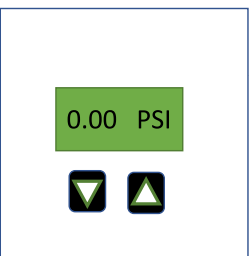
or
5. 

 Press & Hold Arrow Down Key, then press Arrow Up to exit and save changes (hold (x1))

Analog Target Value - Output Pressure

Setpoint Onset

The pressure zero point of the setpoint can be changed using the DaS software. To do this, in the section “Setpoint settings” switch to “Customer”. The maximum adjustment range for the zero point is from -50% to +100%.

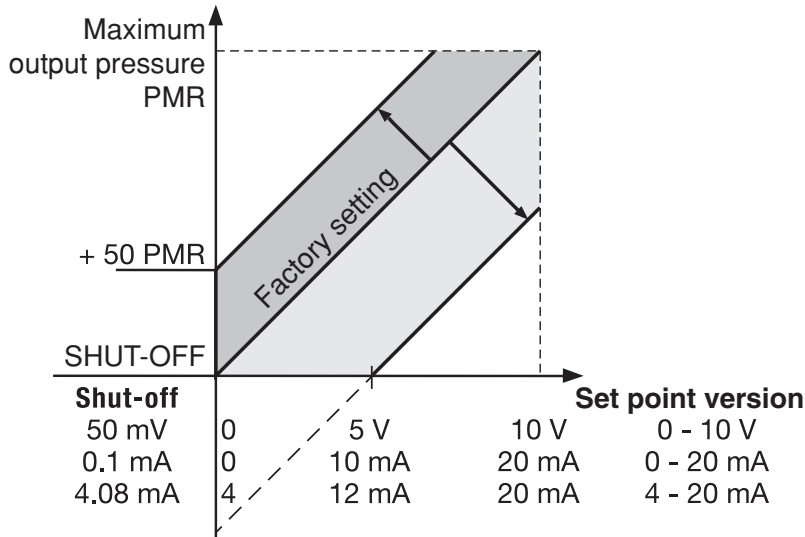

Maximum Output Pressure PMR (psi)	Maximum Input Pressure MAP (psi)
50	90
100	140
150	190

WARNING: Output pressures greater than the PMR (Pressure Maximum Range) will not be regulated by the valve, i.e. the maximum output pressure is limited to the PMR.

In order to prevent damage to the sensor, the supply pressure should always be less than the maximum input pressure (MAP) (see table).

Setpoint span

The pressure range of the target value can be changed using the DaS software. To do this, in the section “Setpoint setting” switch to “Customer”. The adjustment range for the pressure is 10% to 200%.

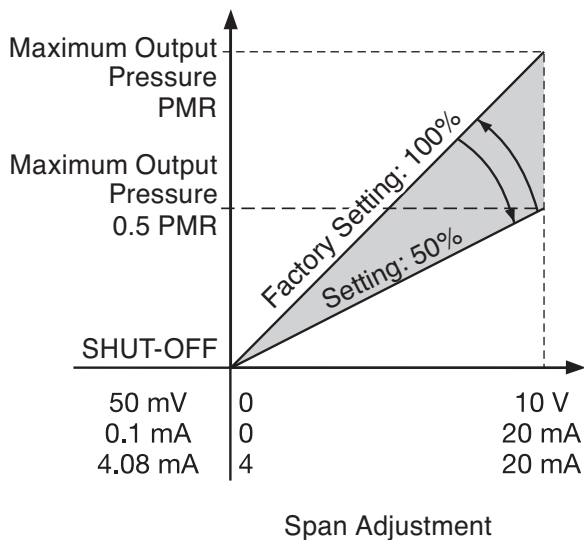

The maximum setting for the pressure range is 200% of the PMR (Pressure Maximum Range).

Pneumatic Connection

The air flow direction is from connection 1 to 2.

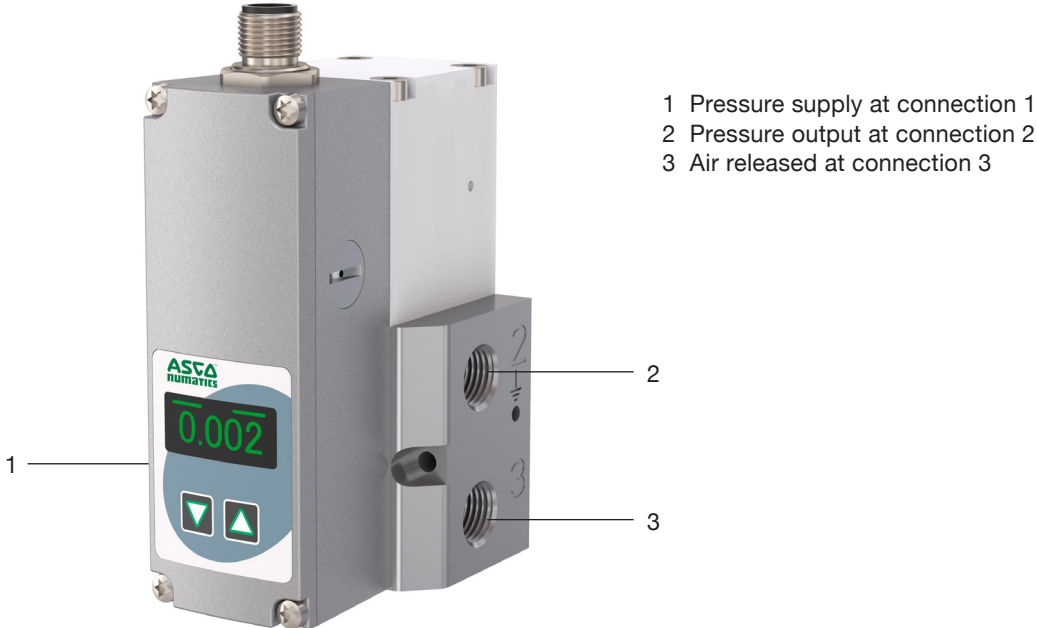

Inch screw connections (pipe threads) are to be used.

Each screw connection must be lined with a fitting plastic sealing ring.

Teflon sealing tape and hemp may not be used, because some of these materials may end up inside the valve.

A suitable silencer is to be used at port (3). Depending on the type of silencer used, the time required for the air to be released may be extended.

The cross-section of the pneumatic lines must be adjusted to the nominal diameter of the valve. The output line (2) should have a cross-section greater than or equal to the input line (1).

The supply pressure must always be less than the value specified in the table in section 3, but it must always be greater than the desired output pressure.

Information on the Factory Settings

- Output pressure: 0 psi with a setpoint of 0 V/0(4) mA
- Pressure range: 50 psi device = 50 psi at 10 V/20 mA
100 psi device = 100 psi at 10 V/20 mA
150 psi device = 100 psi at 10 V/20 mA
- Minimal hysteresis
- The control parameters, the zero point and the pressure range are factory-set.

Set of Parameters: Factory Settings

Zero point: 0%

Pressure range: 100%

Setpoint ramp: none

Shut-off point: ONE; with a target value of less than 0.5%, the air will be released from the valve

Control system: PID

Technical Characteristics

Fluid Characteristics

Fluids:	Air or neutral gas filtered at 50 µm, without condensate, lubricated or unlubricated, class 5 according to ISO 8573-1:2010 [7:4:4]
Max. allowable pressure (MAP):	At least 1 bar above the maximum outlet pressure
Pressure range:	0 – 50 psi, 0 – 100 psi, 0 – 150 psi
Fluid temperature:	0°C to +60°C
Ambient temperature:	0°C to +50°C
Flow (Qv at 6 bar):	470 NI/min – 5200 NI/min
Setpoint:	0 – 10 V (impedance 100 kΩ) 0 – 20 mA/4 – 20 mA (impedance 250 Ω)
Hysteresis:	1% of span
Linearity:	1% of span
Repeatability:	1% of span
Minimum setpoint:	100 mV (0.2 mA/4.2mA) with shutoff function
Minimum outlet pressure:	1% of span
Failsafe behaviour:	Pressure hold on loss of power, without control

Construction

Body:	aluminum
Internal parts:	POM (polyacetal)
Seals:	NBR (nitrile)

Key Values

Electrical Characteristics						
Nominal size DN (mm)	Voltage (compensated)*	Power consumption (W)	Current consumption (mA)	Insulation class	Protection class	Cable connection
4, 8, 15	24VDC	3.8 W ($< 1W$ compensated)	160	H	IP 65	5-pin cable socket M12 (to be ordered separately)

* Residual ripple 10%

Specifications			
Ø Ports NPT or BSPP	Ø Orifice DN (mm)	Flow	
		C _v Flow Factor (K _v Nm ³ /h)	at 6 Bar (l/min - ANR)
1/4	4	0.50 (0.43)	470
3/8	8	1.39 (1.20)	1300
1/2	15	5.57 (4.80)	5200

Test conditions according to ISO 8778: temperature: 20°C, relative input pressure: 6 bar, relative output pressure: 5 bar

Accessories

	5 Pin 12mm FEMALE Straight Field Attachable Connectors	Model Number
	PG 9 Cable Gland	TC05F20000000000
	5 Pin 12mm FEMALE 90 DEGREE Field Attachable Connectors	
	PG 9 Cable Gland	TD05F20000000000
	Micro Female 5 Pole Straight 6 Wire 24 AWG, Shielded	
	3 Meter	TC0503MMS000671Y
	5 Meter	TC0505MMS000671Y
	Micro Female 5 Pole 90 Degree 6 Wire 24 AWG Euro Color Code, Shielded	
	3 Meter	TD0503MMS000671Y
	5 Meter	TD0505MMS000671Y
	Micro F/M 4 Pole Straight 22 AWG Euro Color Code (for connecting to G3 analog I/O modules or digital I/O for 2Bit Setpoint units)	
	Unshielded	Shielded
	3 Meter - TC0403MIETA04000	3 Meter - TC0403MMETA04000
	5 Meter - TC0405MIETA04000	5 Meter - TC0405MMETA04000
	Micro F 90°/M Straight 22 AWG Euro Color Code (for connecting to G3 analog I/O modules or digital I/O for 2Bit Setpoint units)	
	Unshielded	Shielded
	2 Meter - TD0403MIETA04000	3 Meter - TD0403MMETA04000
	5 Meter - TD0405MIETA04000	5 Meter - TD0405MMETA04000
	Manifold (individual subbases that join together)	
	Manifold for 617 DN4 with pressure supply/exhaust 3/8 NPT & output 1/4 NPT 1	N50781800200000
	Manifold for 617 DN4 with pressure supply/exhaust G3/8 & output G1/4 (BSPP) 1	N50781800000000
	PC Software & Cable Connectors	
	DaS Light: Data Acquisition Software for Sentronic ^D - basic parameters - free download at asco.com	99100110
	USB interface for software, 2m cable	N50930300100000
	RS 232 cable converter; 2m cable with 9-pin Sub-D (plug connector)	88100732

¹ Manifold ships with required hardware and gaskets for connecting manifolds together.

Care and Maintenance

Installation and Operating Instructions

1. Before putting the pressure regulator into operation, carry out a careful inspection of the electrical connections and the supply voltage (24 VDC \pm 10%). An overvoltage can damage the electronic systems.
Recommended fuse protection T 2.0 A
2. The electrical connection is made using a circular plug connector M12x1. The connector used must comply with the requirements of German standard DIN 60079-15.

Safety notice:

The plug must not be pulled out when a voltage is running through it!

When the connector plug is removed from its socket, in order to maintain the IP protection class, the protective cap supplied with the device must be fitted.

3. For the electrical connection of the valve, shielded cables must be used. The shielded connection, plug and switch cabinet must comply with EMC requirements. The valve body must be electrically grounded (protective earthing, machine grounding). Do not install control cables parallel to power cables or control cables of servomotors etc.
4. The cable cross-section area of the supply voltage cable should be at least 0.25 mm².
If long supply cables are used, it may be appropriate for them to have an even larger cable cross-section area.
5. Make sure that the valve is subjected to pressure as soon as a target value signal is sent to the valve (if a target value setting is sent to the valve without the valve being under pressure, this will result in unacceptable excessive heating of the valve).
6. The device is calibrated with factory settings.
7. The device must be sent to the factory if repairs are needed.

Safety Instructions

These products must only be used in industrial compressed air systems. These products are to be used in locations where the pressures and temperatures listed under "Specifications" are not exceeded. Please take note of the relevant page in the instruction manual.

Before using these products with fluids other than those specified in the manual, or in non-industrial applications, life-support systems, or in other systems which are not specified in the published instruction manuals, please contact ASCO Numatics directly.

The components used in fluid power systems can fail in various ways due to misuse, wear or system malfunctions.

System designers are warned to make it a priority to take into account the possible types of faults of all component parts used in fluid power systems, and to provide adequate safeguards to prevent injuries to staff or damage to equipment in the event of such faults.

System designers must provide safety instructions for the end users in the operating manual if protection against faults cannot be sufficiently guaranteed.

System designers and end users are strongly advised to comply with the safety instructions provided with these products.

Dimensions: mm

DN 4

Inline version

Weight: 0.49kg (1.08lbs)

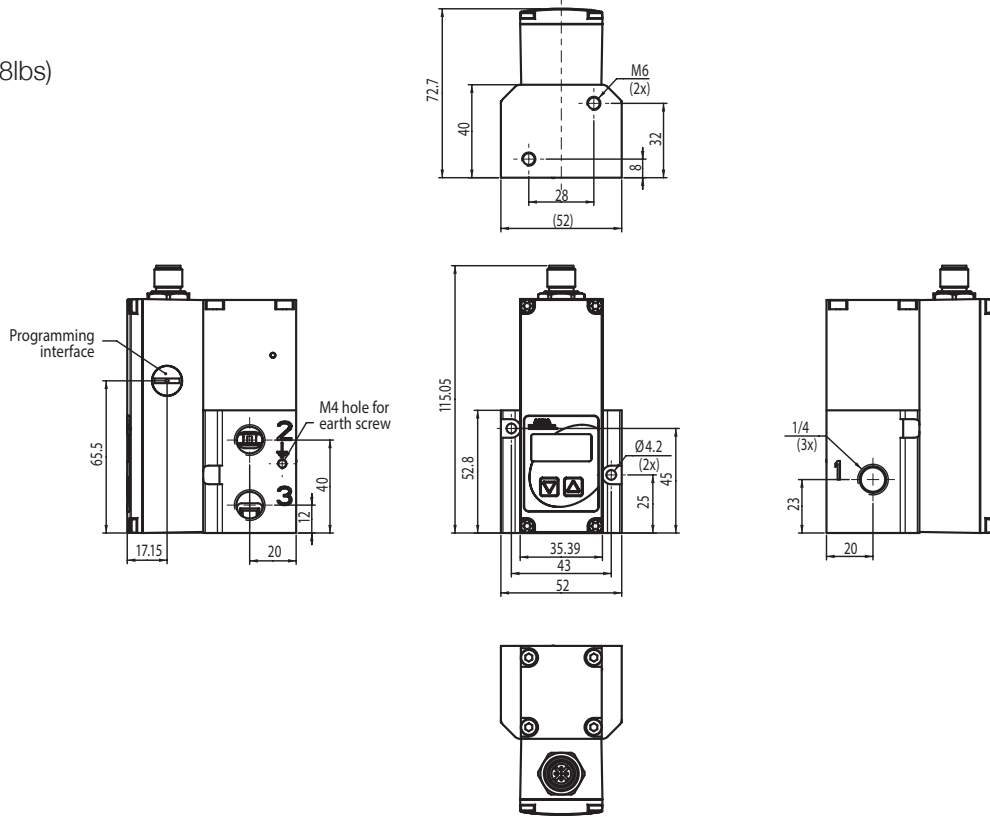

DN 4

Subbase version

Weight: 0.49kg (1.08lbs)

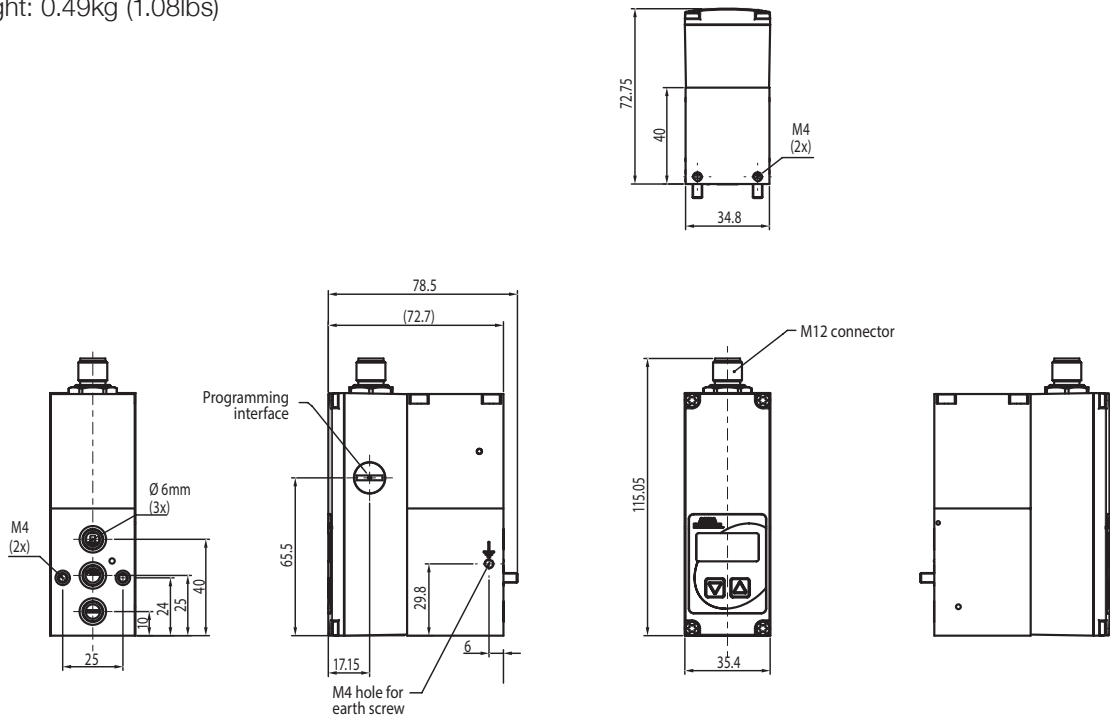

Dimensions: mm

DN 4

Joinable subbase

Weight: 0.3kg (0.66lbs)

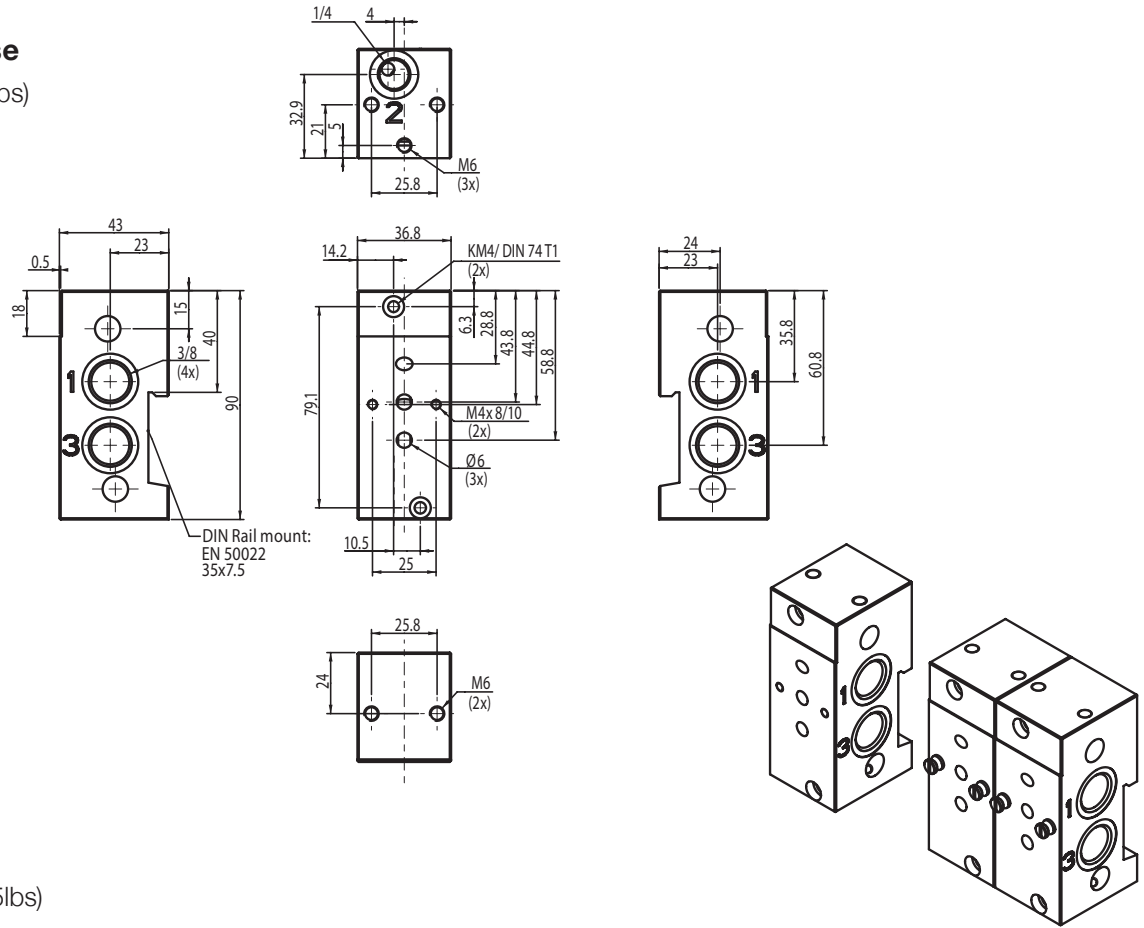

DN 8

Weight: 0.93kg (2.05lbs)

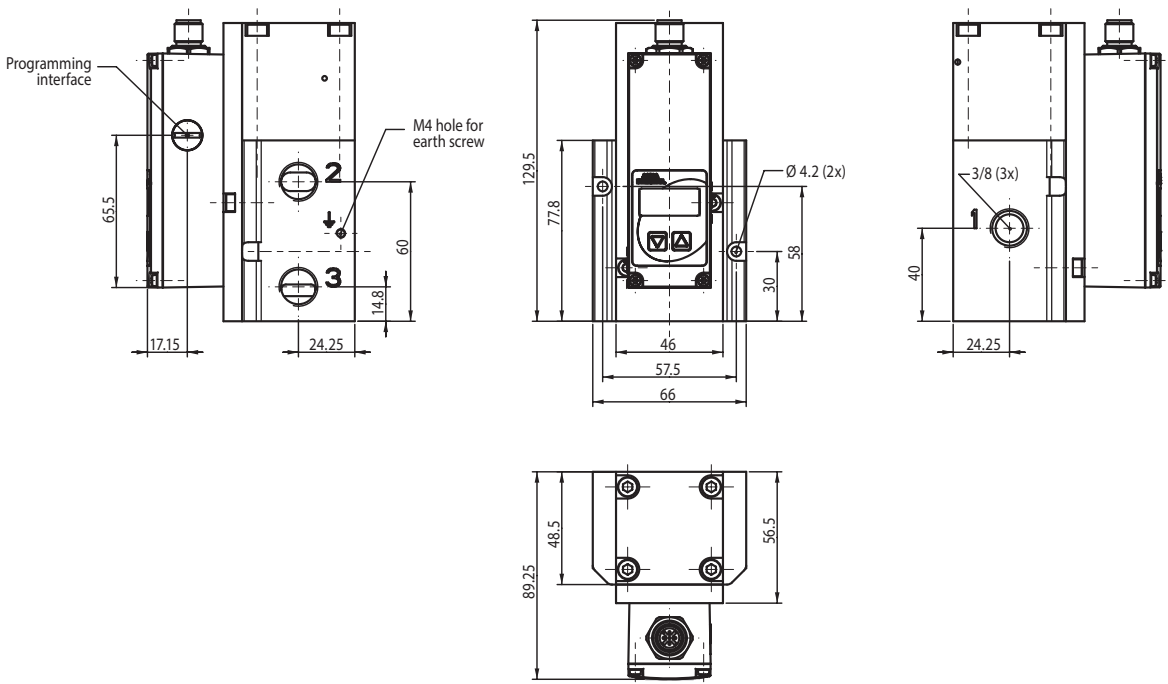

Dimensions: mm

DN 15

Weight: 1.33kg (2.93lbs)

