

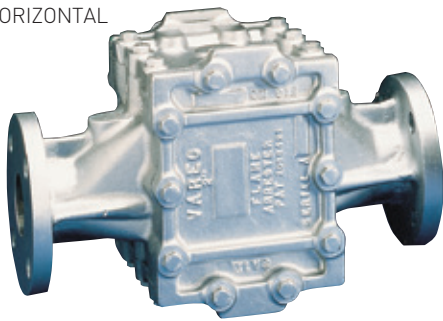

VAREC 5000/5010 SERIES FLAME ARRESTERS

Group 'D' end-of-line flame arresters with a unique extensible bank frame designed to stop the propagation of flame from external sources

5010 SERIES -
HORIZONTAL



5000 SERIES -
VERTICAL



FEATURES

- Models available for vertical or horizontal configurations.
- Heavy wall cast housing in 356 T6 aluminum, carbon steel or 316 stainless steel.
- Net free area through banks three to four times the unit pipe size, resulting in increased flow capacity with minimal pressure drop.
- Bank's large surface area improves heat dissipation.
- Removable cover plate and extensible bank assembly for easy inspection, cleaning or replacement.
- Unitized housing does not require support for proper bank alignment during maintenance.
- 'Off-set' housing design ensures flow capacity unaffected by condensate accumulation, even when installed in horizontal piping.
- 5010 Series 1/2" NPT drain plug at the low point is located conveniently for routine draining*.
- UL approved**.

* A Varec drip trap should be specified for field installation at this connection to provide for safe removal of condensate.

** For approved sizes please see page 2.

GENERAL APPLICATION

The 5000 and 5010 Series, Group 'D', end-of-line flame arresters are used in gas piping systems, petroleum storage tank roofs and digester covers to prevent the propagation of a flame into the system.

TECHNICAL DATA

Materials:	Aluminum, carbon steel, stainless steel
Sizes:	2" to 12" (50 to 300 mm)
Connections:	Drilled flanges
Pressure rating:	To 10 psi (0.7 bar)

VAREC 5000/5010 SERIES FLAME ARRESTERS

SPECIFICATIONS

MODELS OVERVIEW

5000 and 5010 Series flame arresters stop the propagation of a flame by absorbing and dissipating heat through the surface area of the bank sheets. Ignited vapor attempting to pass through the arrester is forced through small passages within the bank assembly. Heat is absorbed, lowering the temperature of the gas below its ignition point and quenching the flame.

5000 Series is for vertical installation; 5010 Series is for horizontal or vertical installation. They can be mounted up to 15 feet (4.6 m) upstream of the ignition source in accordance with UL approval, or 10 pipe diameters in accordance with FM approval requirements.

Sizes

2", 3", 4", 6", 8", 10" and 12"

Connections

Aluminum drilled to ANSI Class 150 dimensions, flat face flange.

Carbon steel and 316 stainless steel drilled to ANSI Class 150 dimensions, raised face flange.

Special drilling of flange connections to DIN, JPI or JIS standards available upon request.

Consult your local sales representative for further details.

Pressure rating

Leak proof to 10 psi (69.0 kPa), standard.

Higher ratings available: consult sales.

Pressure drop

Should not exceed 1 psi (6.9 kPa).

Location ^[1]

Within 15 feet (4.6 m) upstream of flame source.

Configuration

Net free area

Three to four times the corresponding size standard pipe.

Bank assembly

Extensible aluminum bank frame with corrugated rectangular shaped bank sheets.

Fixed 316 stainless steel bank frame.

Provision for draining

5000 Series self draining.

5010 Series includes 1/2" NPT connection at low point.

Housing materials

356 - T6 low copper aluminum - standard.

Carbon steel (ASTM A216 grade WCB) - optional.

316 stainless steel - optional.

Bank assembly material

Low copper aluminum extensible frame with aluminum bank sheets - standard.

Low copper aluminum extensible frame with 316 stainless steel bank sheets - optional.

All 316 stainless steel fixed frame with 316 stainless steel bank sheets - optional (available with carbon steel or 316 stainless steel housing only).

Approvals

5000 Series UL (Underwriters Laboratories) listed in all aluminum construction with extensible bank assembly in 2", 3", 4", 6" and 10" sizes^[1].

5010 Series UL listed in all aluminum construction as above in 2", 3" and 4" sizes^[1].

EXTENSIBLE ALUMINUM BANK FRAME



Closed

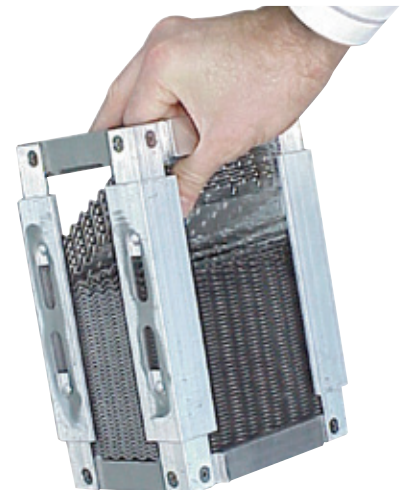

Open

NOTE

1. For use on hydrocarbon storage tanks, installed NOT MORE THAN 15 FEET from the open end of the vent pipe. These test conditions may not represent the actual service conditions of piping system design.

It is recommended that the arrester be independently tested under actual service conditions before installation.

VAREC 5000/5010 SERIES FLAME ARRESTERS

DIMENSIONS AND WEIGHTS

5000 SERIES

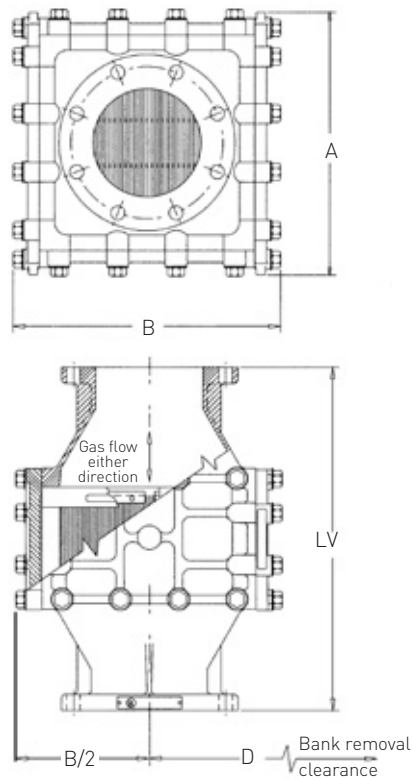

5010 SERIES

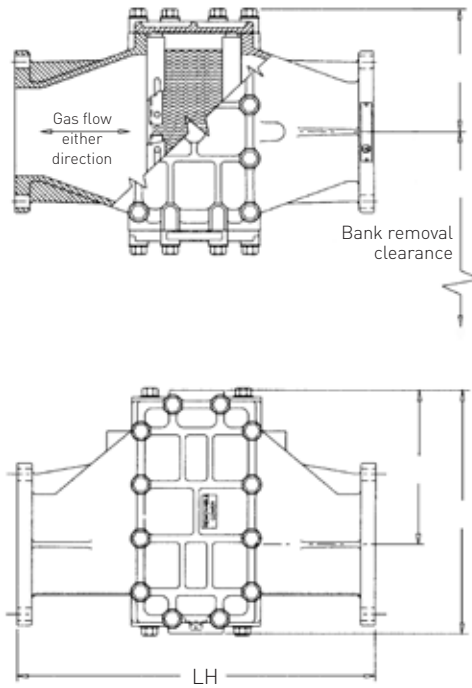

DIMENSIONS, INCHES AND POUNDS (millimeters and kilograms)

Size code	Nominal pipe size	L _V length (5000)	L _H length (5010)	A Width	B Depth	C CL offset (5010)	D Bank clearance	Aluminum Shipping wt. (5000)	Aluminum Shipping wt. (5010)
2	2 [50]	12 ⁵ / ₈ [321]	14 ¹ / ₂ [368]	9 [229]	8 ⁵ / ₈ [219]	5 ³ / ₈ [137]	19 [483]	25 [11]	30 [14]
3	3 [80]	13 ³ / ₈ [352]	16 [406]	11 ¹ / ₄ [298]	11 ¹ / ₂ [292]	7 ¹ / ₄ [184]	23 ¹ / ₄ [591]	45 [20]	50 [23]
4	4 [100]	16 ⁵ / ₈ [422]	20 [508]	14 ¹ / ₂ [368]	14 ³ / ₄ [375]	9 [229]	28 ¹ / ₈ [714]	65 [30]	70 [32]
6	6 [150]	21 ¹ / ₂ [546]	24 ³ / ₈ [619]	16 ¹ / ₂ [419]	16 ³ / ₄ [425]	10 ³ / ₄ [273]	31 ¹ / ₈ [791]	100 [45]	115 [52]
8	8 [200]	27 ¹ / ₄ [692]	32 ¹ / ₈ [816]	21 ¹ / ₈ [549]	21 ¹ / ₄ [552]	14 ³ / ₈ [365]	38 ⁵ / ₈ [981]	200 [91]	220 [100]
0	10 [250]	28 ³ / ₈ [721]	35 ¹ / ₂ [902]	24 [610]	23 ³ / ₄ [603]	16 [406]	41 ¹ / ₈ [1057]	240 [109]	270 [123]
1	12 [300]	34 ³ / ₈ [873]	34 ³ / ₈ [873]	31 [787]	29 ¹ / ₄ [743]	20 [508]	50 [1270]	350 [159]	375 [170]

Flange drilling per ANSI Class 150 flat face flange (aluminum); per ANSI Class 150 raised face flange (carbon steel and 316 stainless steel).

VAREC 5000/5010 SERIES FLAME ARRESTERS

FLOW CURVES

5000 AND 5010 FLAME ARRESTERS

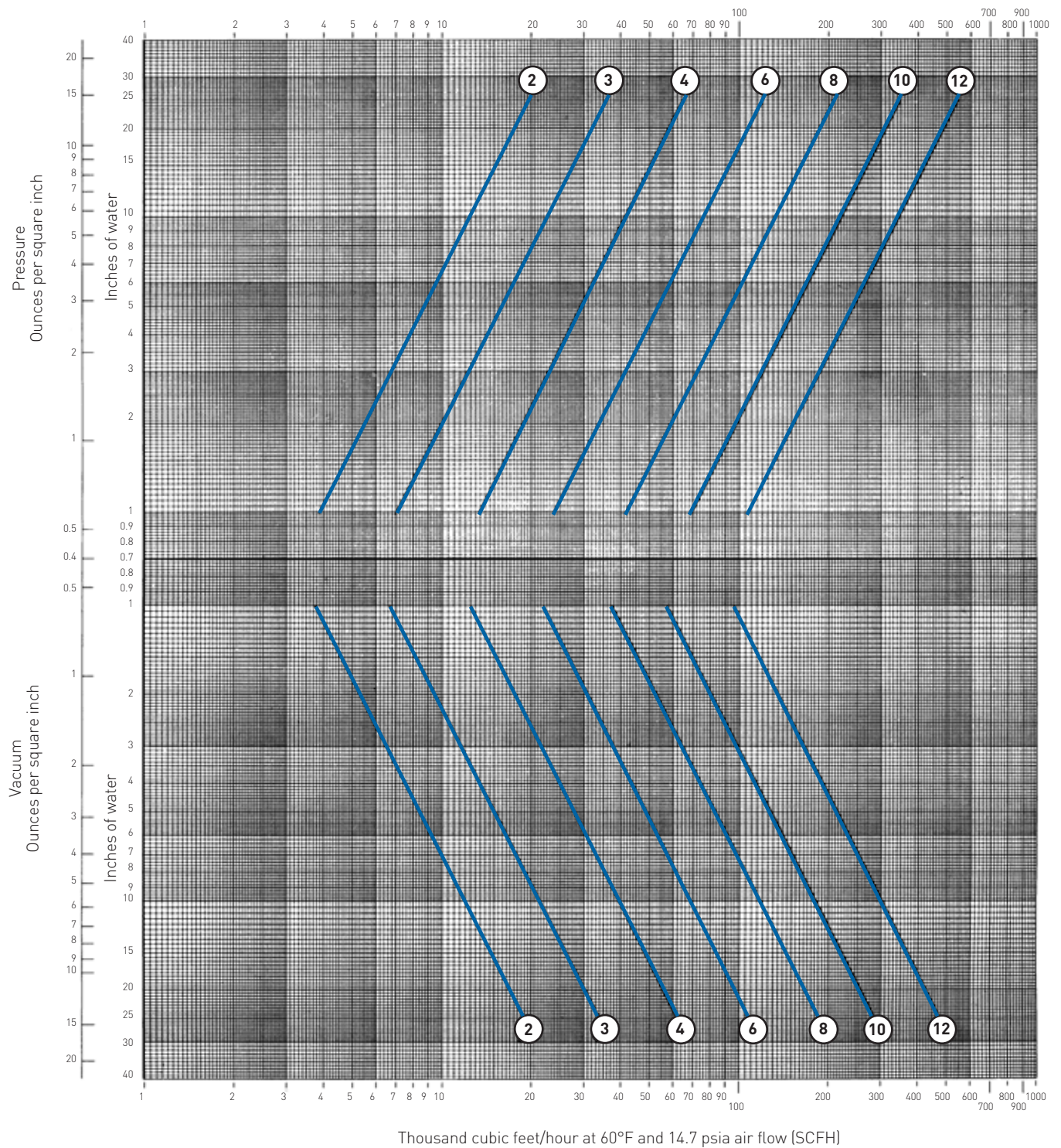

VAREC 5000/5010 SERIES FLAME ARRESTERS

FLOW CURVES

Combination 2010B valve and 5000 flame arrester, set at 0.865 inch of water

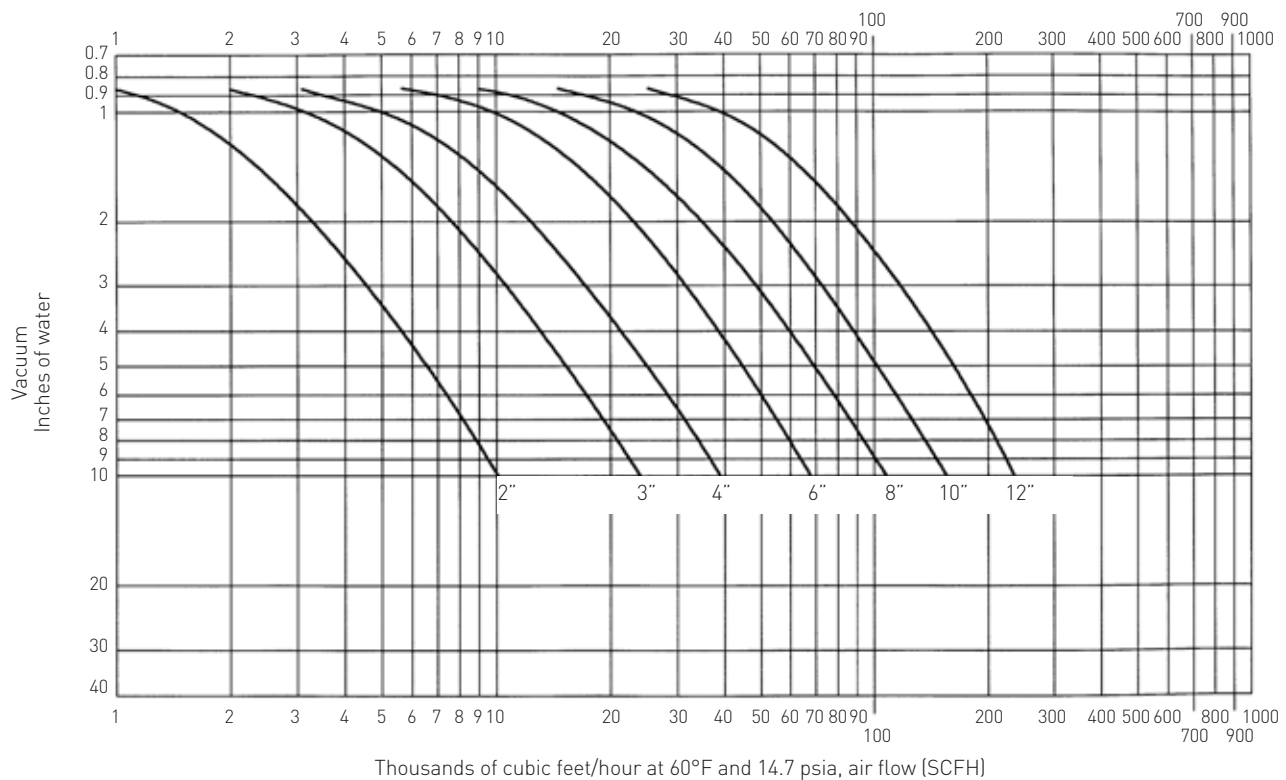
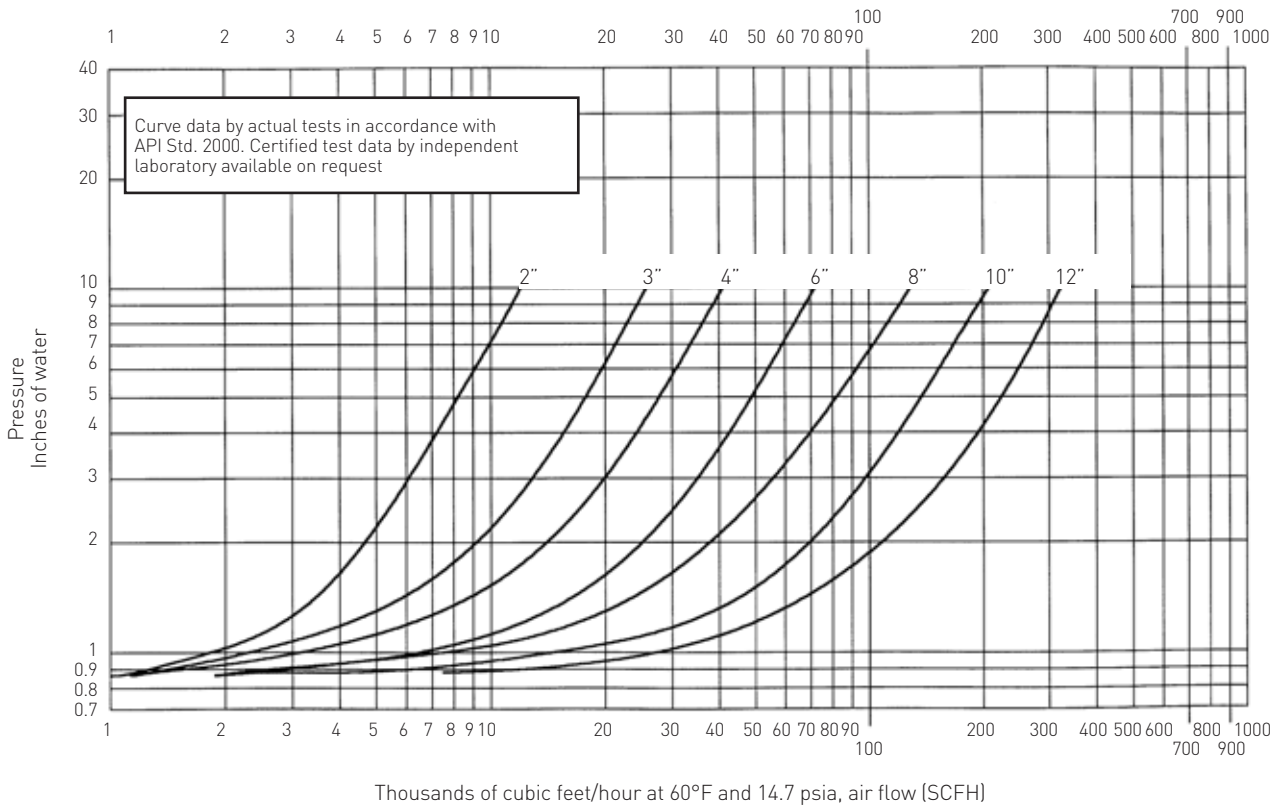

VAREC 5000/5010 SERIES FLAME ARRESTERS

FLOW CURVES

Combination 2010B valve and 5000 flame arrester, set at 1 inch of water

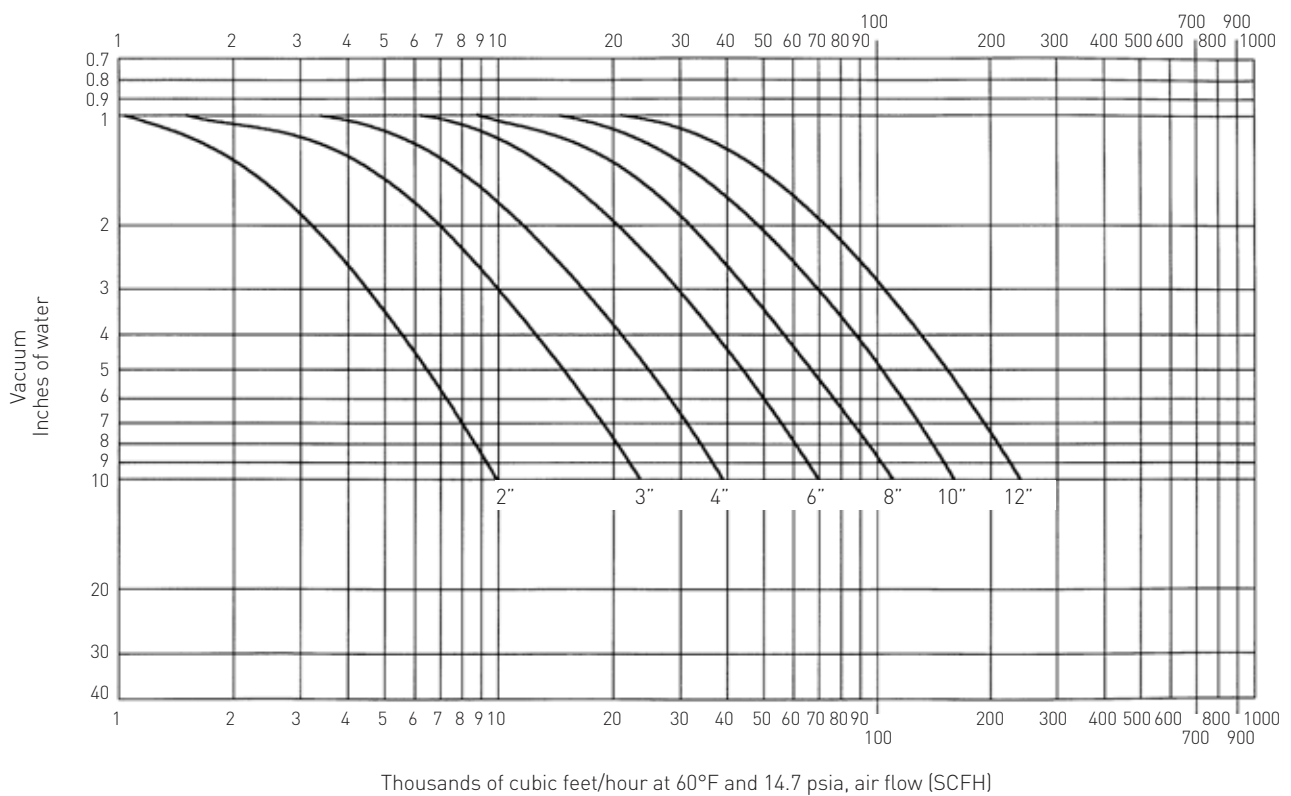
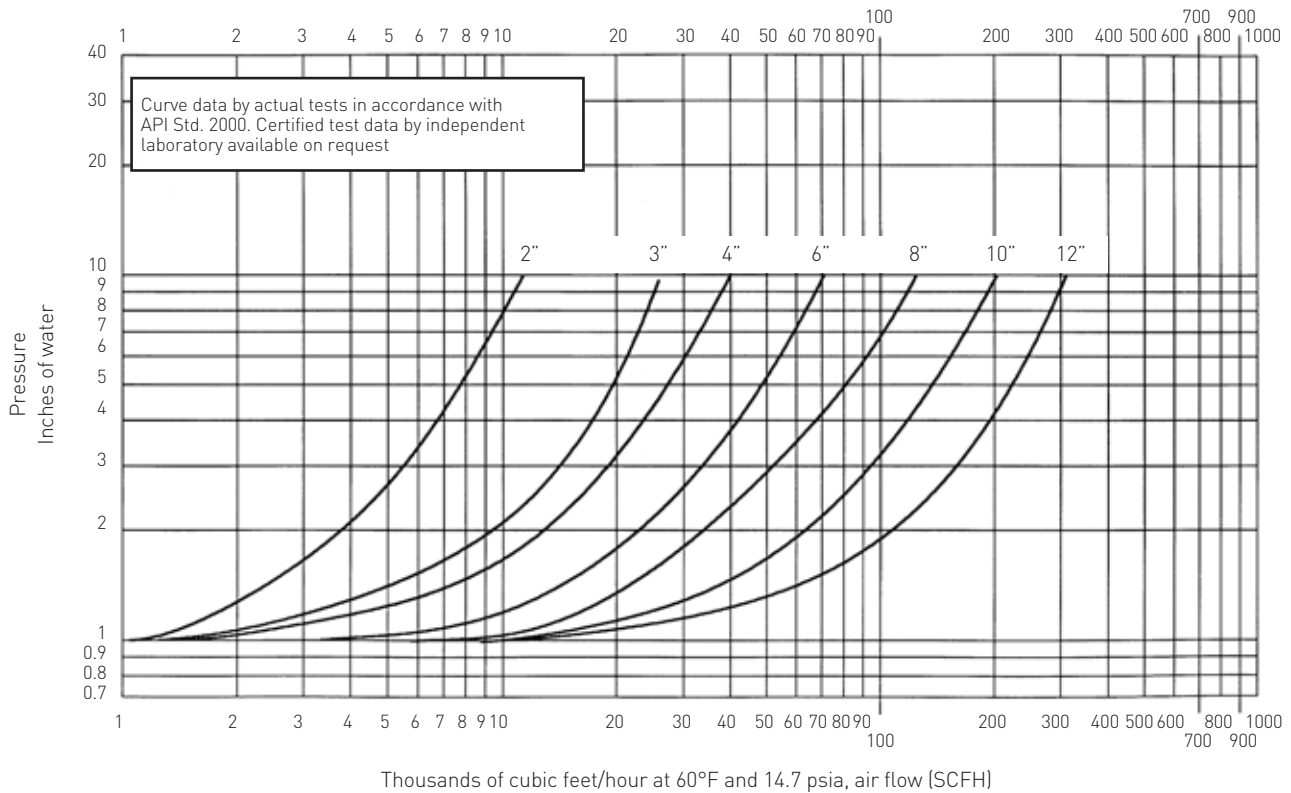

VAREC 5000/5010 SERIES FLAME ARRESTERS

FLOW CURVES

Combination 2010B valve and 5000 flame arrester, set at 2 inches of water

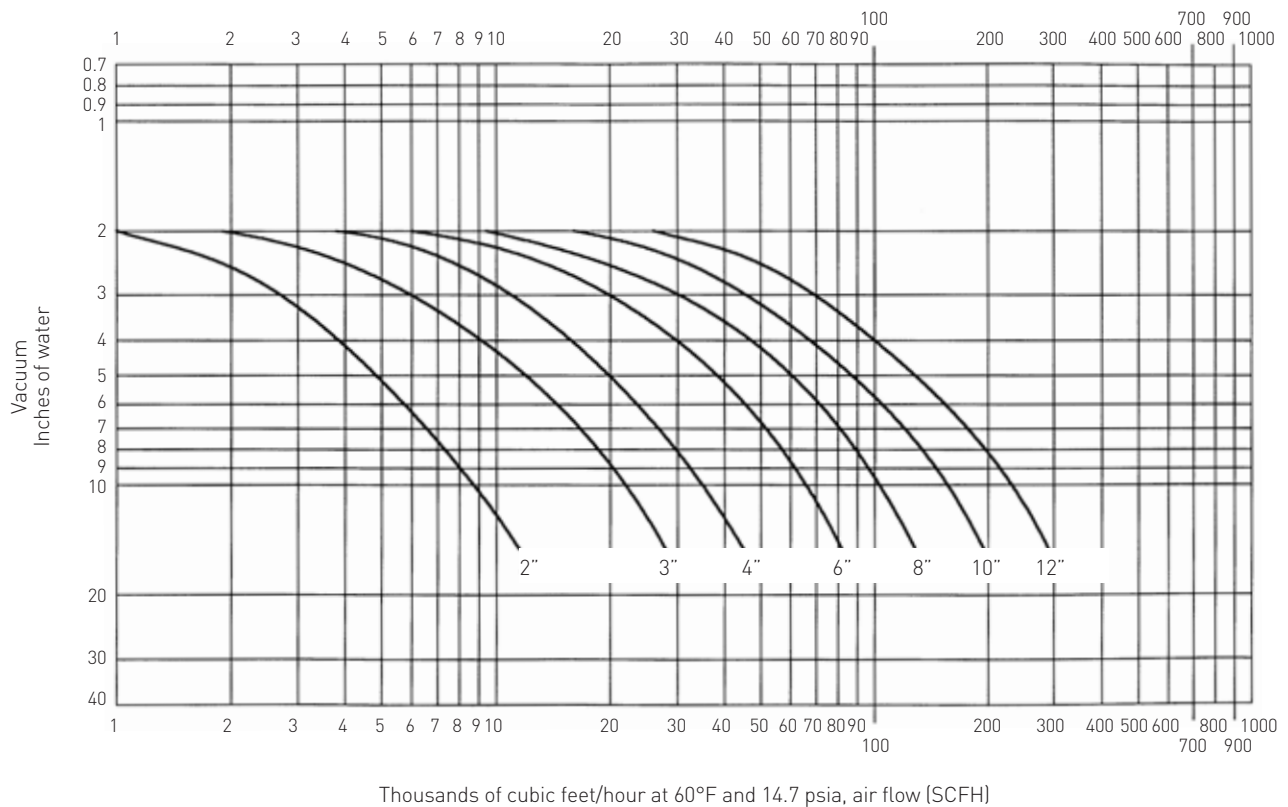
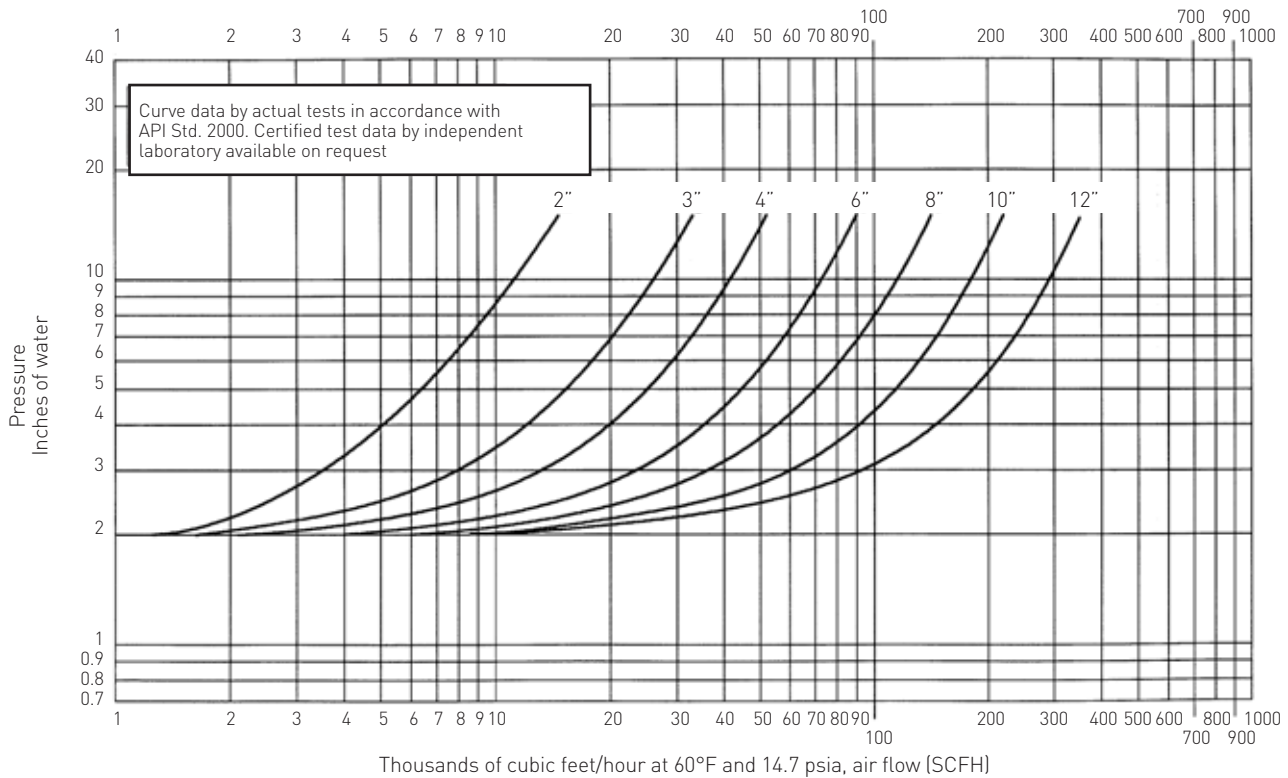

VAREC 5000/5010 SERIES FLAME ARRESTERS

FLOW CURVES

Combination 2010B valve and 5000 flame arrester, set at 4 inches of water

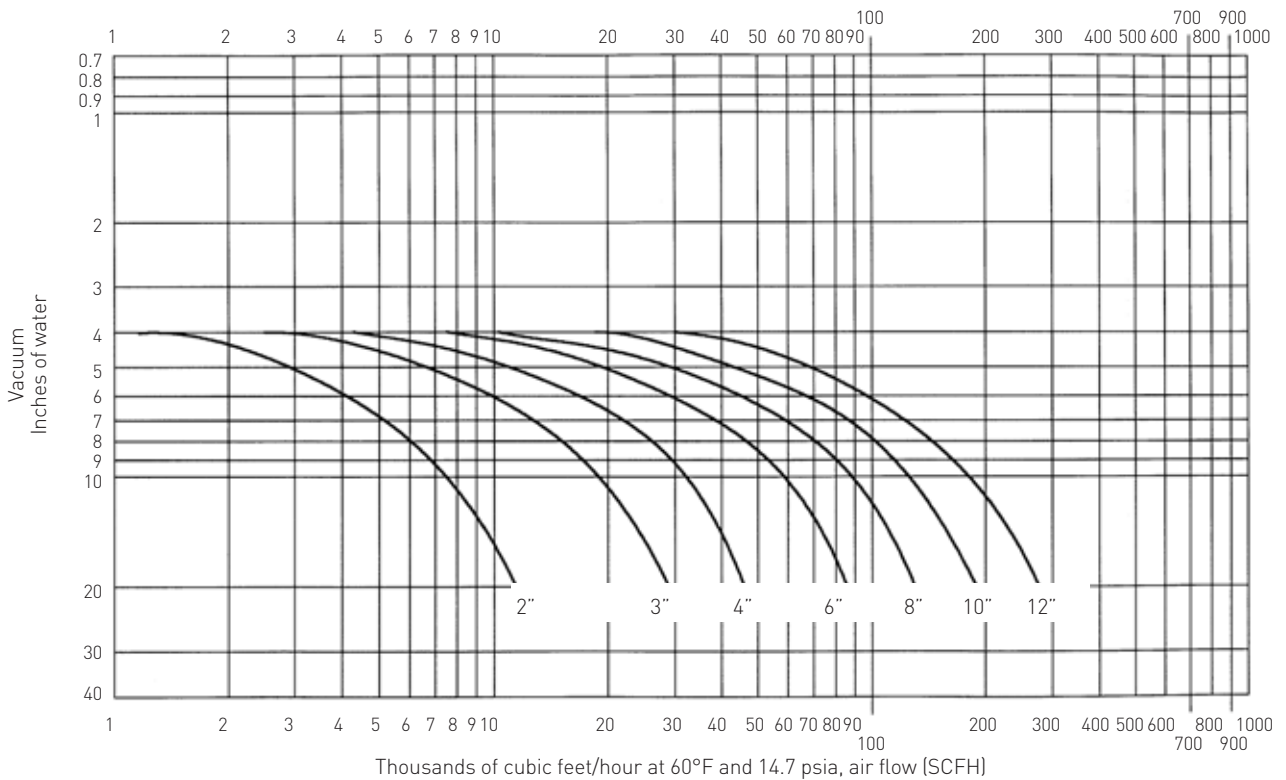
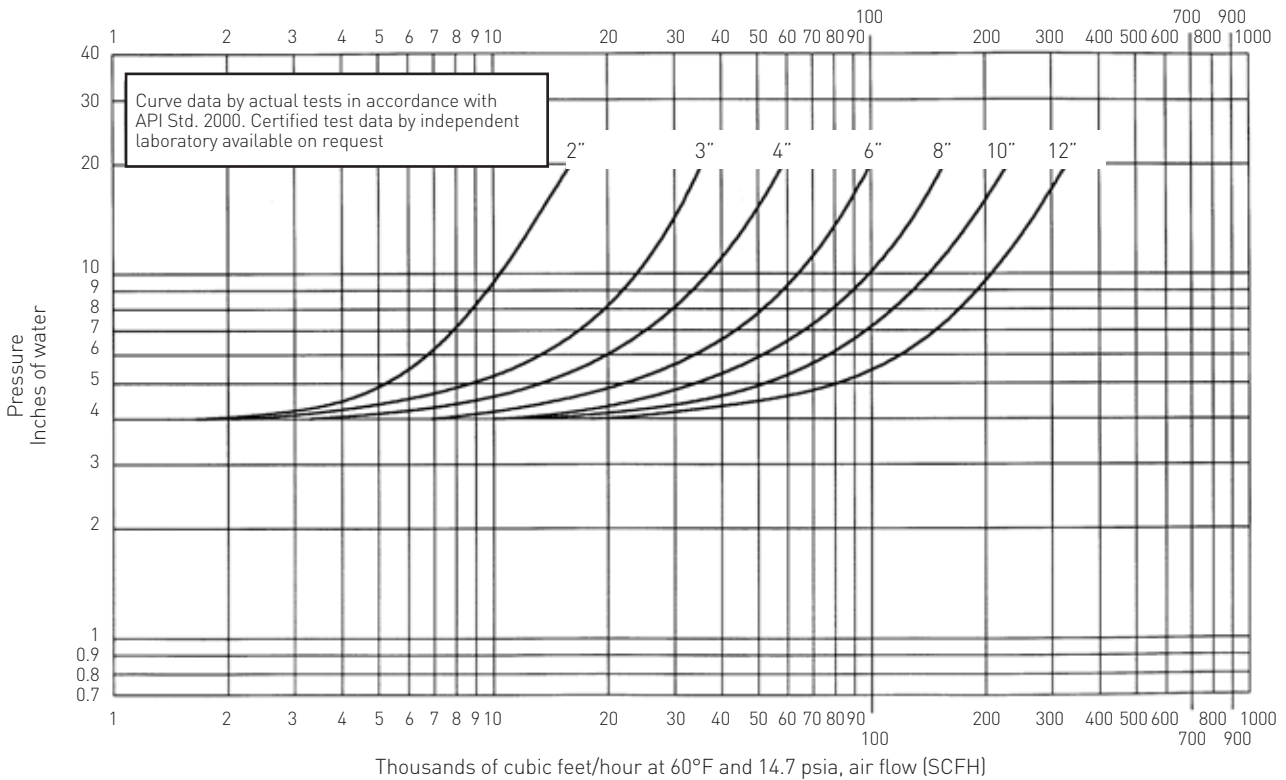

VAREC 5000/5010 SERIES FLAME ARRESTERS

FLOW CURVES

Combination 2010B valve and 5000 flame arrester, set at 6 inches of water

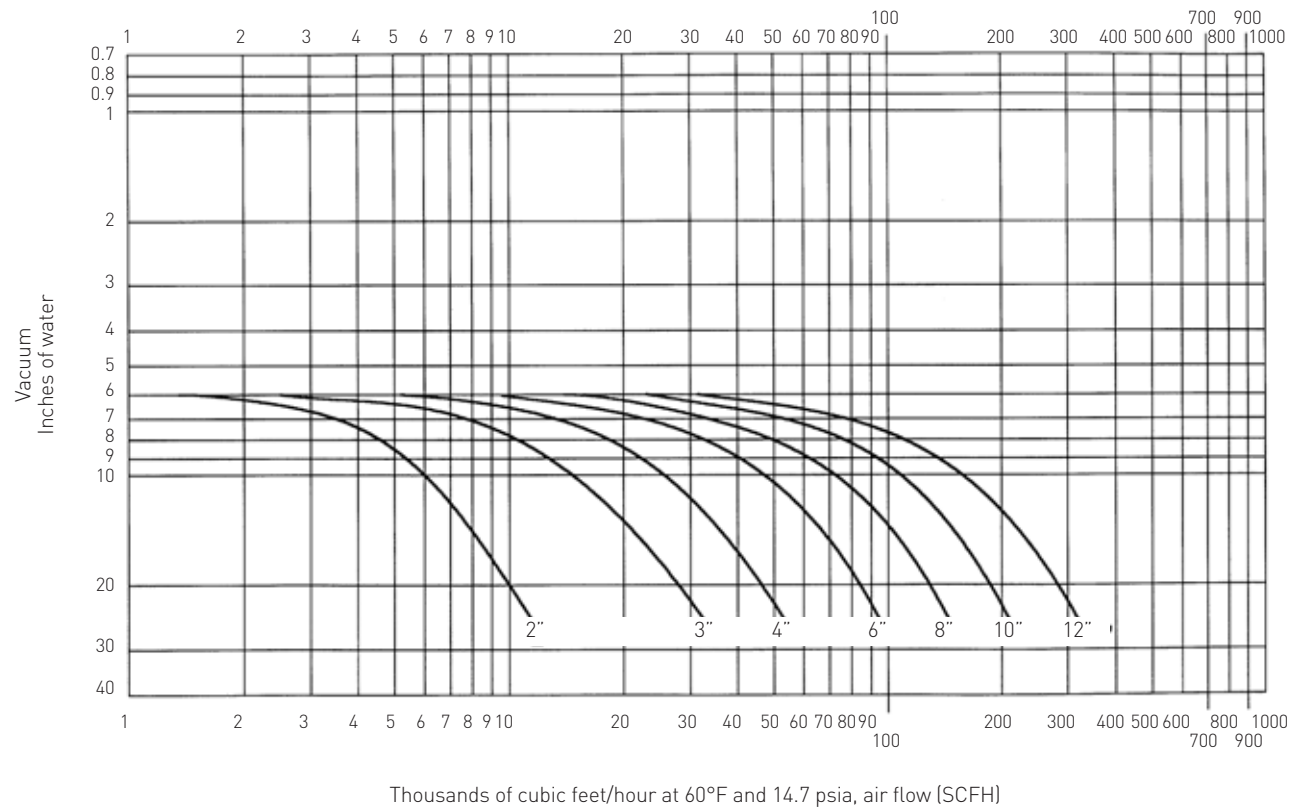
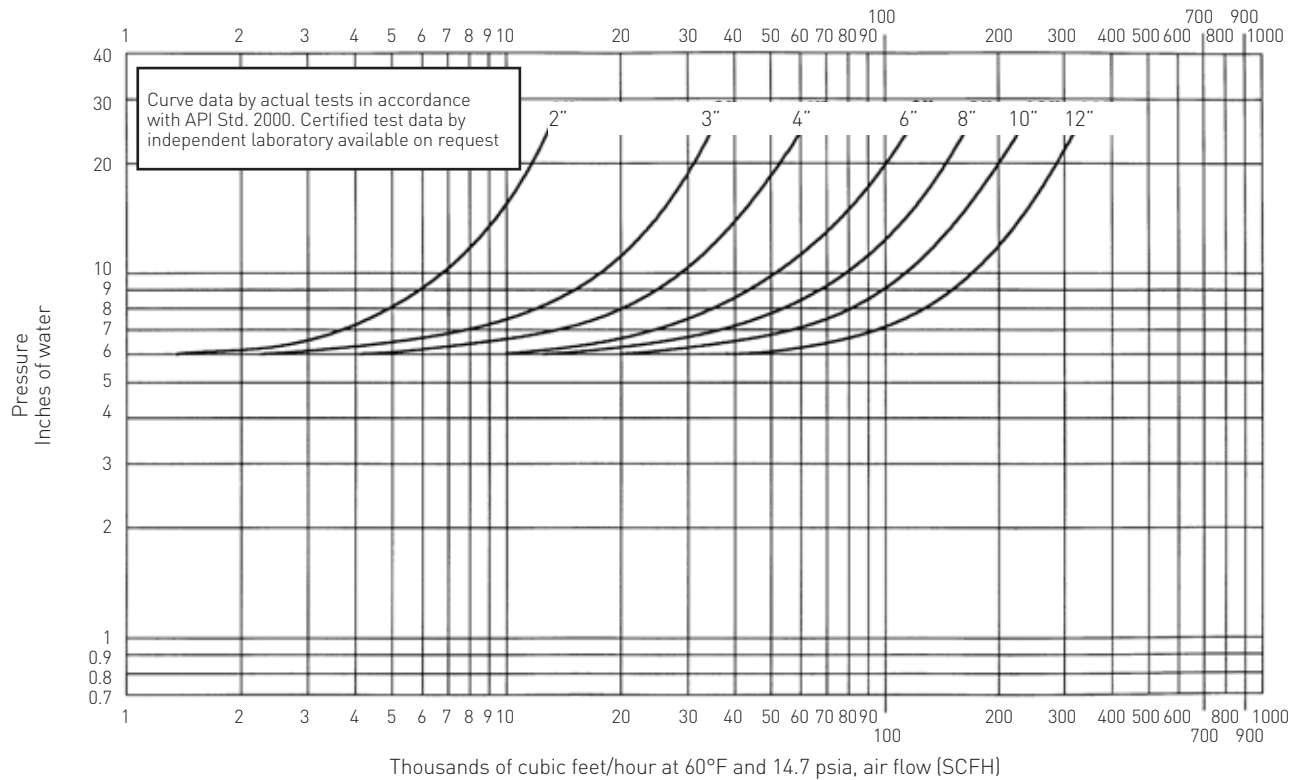

VAREC 5000/5010 SERIES FLAME ARRESTERS

ORDERING INFORMATION

SELECTION GUIDE

Example:	50	00	2	6	S
Model					
50	Flame arrester				
Configuration					
00	Vertical				
10	Horizontal				
Size					
2	2"				
3	3"				
4	4"				
6	6"				
8	8"				
0	10"				
1	12"				
Housing/bank assembly frame/sheet material					
1	Aluminum/aluminum (extensible frame)/aluminum				
2	Aluminum/aluminum (extensible frame)/316 stainless steel				
3	Carbon steel/316 stainless steel (fixed frame)/316 stainless steel				
6	316 stainless steel/316 stainless steel (fixed frame)/316 stainless steel				
Hardware material					
S	Stainless steel				
*	Zn plated carbon steel (standard) - leave blank				

Example: vertical configuration flame arrester. 2" size all 316 stainless steel construction with stainless steel hardware.

