

Cen-Stat™

Static Grounding Clamps, Cables and Reels



Cen-Stat Static Grounding Clamps and Cables



Equipment can only be grounded by ensuring a low resistance connection to verified true earth grounding points (e.g. wall-mounted earth bar). Other equipment used in the process can be bonded to the equipment that is grounded.

Static grounding systems like the Earth-Rite® range combine interlock control and visual indication to verified ground connection points and offer the highest levels of protection over electrostatic ignition risks. However, equipment specifiers may select passive grounding devices, like single pole clamps, to ground and bond plant equipment.

ATEX, FM and IECEx approved clamps tested for:

- Clamp Pressure
- Electrical Continuity
- High Frequency Vibration
- Mechanical Pull

IEC TS 60079-32-1, 13.4.1 states:

Where wire conductors are used, the minimum size of the bonding or earthing wire is dictated by mechanical strength, not by its current-carrying capacity. Stranded or braided wires should be used for bonding wires that will be connected and disconnected frequently.

Temporary connections can be made using bolts, pressure-type earth (ground) clamps, or other special clamps. Pressure-type clamps should have sufficient pressure to penetrate any protective coating, rust, or spilled material to ensure contact with the base metal with an interface resistance of less than 10 Ω*.

*the underlined wording is additional wording present in IEC TS 60079-32-1.



Tungsten carbide teeth are designed to penetrate electrical impedances caused by rust, coatings and product deposits.



Static grounding clamps must be capable of breaking through coatings, product deposits and rust to ensure a good electrical connection to process equipment. Operators should be trained to toggle the clamp back and forth to bite through the coating and establish a visual connection to the base metal.

Cen-Stat™

What is Cen-Stat cable?

Cen-Stat is a range of brightly coloured cables specially designed for applications in industrial and hazardous areas.

Cen-Stat cables are based upon Hytrel® that combines the flexibility of rubber with the strength and process flexibility of thermoplastics.

Cables made from Hytrel are mechanically resilient, have a wide working temperature and are resistant to a wide range of chemicals, as well as strong and durable.

Included in our Cen-Stat formulation is static dissipative material that limits the cable from carrying an electrostatic charge and additives that provide protection against exposure to ultra-violet light.

The conductor is composed of multi-stranded galvanized steel threads providing a conductor cross-sectional area of 11 AWG (4 mm²), and with the coating included provides a cable diameter of 0.25" (6.5mm). Cen-Stat is supplied in standard retractable spiral lengths of 10 ft (3 m), 16 ft (5 m), and 32 ft (10m). Cen-Stat is supplied with Newson Gale's heavy duty clamps. Other lengths are available on request.

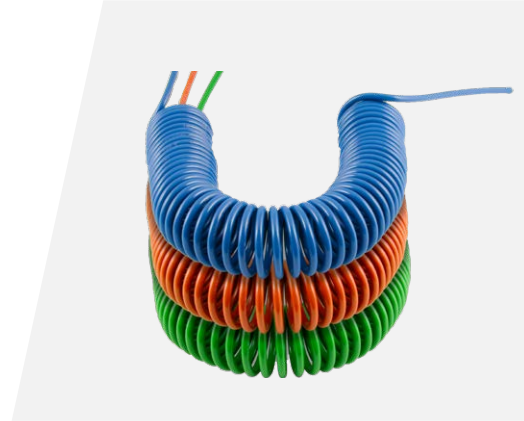

Cen-Stat cable

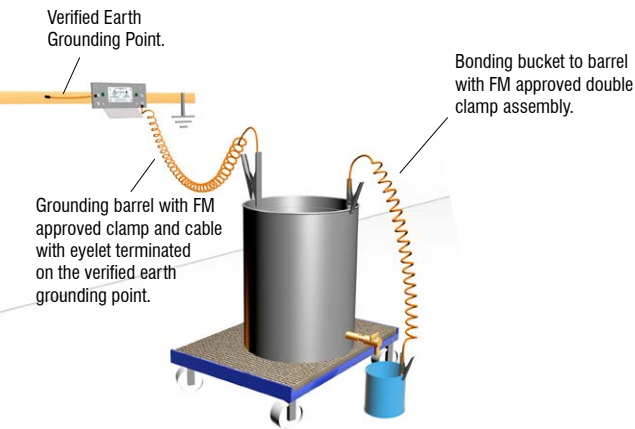

Cen-Stat cable is used across all Newson Gale product categories

Blue Cen-Stat

Active grounding cable colour carrying intrinsically safe circuits

Green Cen-Stat

Passive grounding cable colour coded for Europe and the rest of the world

Orange Cen-Stat

Passive grounding cable colour coded for North and South America

To remove static electricity from the EX/HAZLOC atmosphere grounding clamps should be capable of achieving connections to equipment with resistance values that do not exceed 10 Ohms.

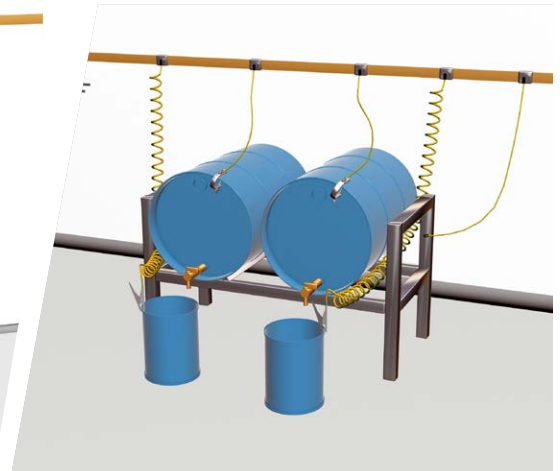

Cen-Stat™

VESX90 - Large size heavy duty static grounding clamp with Cen-Stat cable

Applications:	Grounding and bonding metal objects ranging from 55 gallon drums to large metal totes and IBCs
Clamp Material:	Stainless Steel (SS grade: 304)
Operating Temperature:	40°F to +140°F (-40°C to +60°C)
Dimensions:	9.4" x 4.1" x 1.3" (240 mm x 105 mm x 33 mm)
Maximum Jaw Opening:	1.8" (30 mm) approx.
Clamp Teeth:	2 tungsten carbide teeth - set side by side in a stainless steel mounting block for extra stability
Spring:	Torsion spring (3.5 turn design) Stainless steel (SS Grade: 302)
Cable Supplied:	10 ft (3 m), 16 ft (5 m) or 32 ft (10 m) Cen-Stat spiral multi-stranded galvanized steel with orange anti-UV / static dissipative Hytrel coating
Cable Size:	Conductor cross sectional area - 11 AWG (4 mm ²) approx. with Cen-Stat coating - 0.25" (6.5 mm) diameter
Ring Terminal:	0.4" (10 mm) hole diameter (standard) Other sizes available on request



ATEX / FM / IECEx / UKEX Clamp Certification:

ATEX

 II 1 GD T6 (Assessed to EN 13463-1 : 2009)
Sira 02ATEX9381
ATEX Notified Body: SIRA

FM Certificate of Compliance number: 3046346

IECEx

Ex h IIC T6 Ga
Ex h IIIC T85°C Da
Ta = -40°C to +60°C
IECEx EXV 20.0033
IECEx Certified Body: ExVeritas

UKCA Ex

 II 1 G
II 1 D
Ex h IIC T6 Ga
Ex h IIIC T85°C Da
Ta = -40°C to +60°C
ExVeritas 21UKEX0842
UKCA Ex Approved Body: ExVeritas

Cen-Stat™

VESX45 - Medium size heavy duty static grounding clamp with Cen-Stat cable

Applications:	Grounding and bonding metal objects ranging from small cans to 55 gallon drums
Clamp Material:	Stainless Steel (SS grade: 304)
Operating Temperature:	-40°F to +140°F (-40°C to +60°C)
Dimensions:	4.7" x 2.6" x 1.0" (120 mm x 65mm x 25 mm)
Maximum Jaw Opening:	0.6" (15 mm) approx.
Clamp Teeth:	2 tungsten carbide teeth - set side by side in a stainless steel mounting block for extra stability
Spring:	Torsion spring (4 turn design) Stainless steel (SS Grade: 302)
Cable Supplied:	10 ft (3 m), 16 ft (5 m) or 32 ft (10 m) Cen-Stat spiral multistranded galvanized steel with orange anti-UV / static dissipative Hytrel coating
Cable Size:	Conductor cross sectional area - 11 AWG (4 mm ²) approx. with Cen-Stat coating - 0.25" (6.5 mm) diameter
Ring Terminal:	0.4" (10 mm) hole diameter (standard) Other sizes available on request



ATEX / FM / IECEx / UKEX Clamp Certification:

ATEX

 II 1 GD T6 (Assessed to EN 13463-1 : 2009)
Sira 02ATEX9381
ATEX Notified Body: SIRA

FM Certificate of Compliance number: 3046346

IECEx

Ex h IIC T6 Ga
Ex h IIIC T85°C Da
Ta = -40°C to +60°C
IECEx EXV 20.0033
IECEx Certified Body: ExVeritas

UKCA Ex

 II 1 G
II 1 D
Ex h IIC T6 Ga
Ex h IIIC T85°C Da
Ta = -40°C to +60°C
ExVeritas 21UKEX0842
UKCA Ex Approved Body: ExVeritas

Cen-Stat™

Heavy Duty grounding clamps with cable reels

Retracting cable reels are an alternative solution to using retractable Cen-Stat spiral cable. They are normally specified for locations where there is a preference for ensuring process operators stow grounding clamps correctly for good “housekeeping” purposes when the clamps are not in use.

Newson Gale’s “R-series” of static grounding reels offer Hytrel cable housed on automatically retractable cable reel.

The R-series of retractable cable reels are supplied in 20 ft (6.1 m), 30 ft (9.1 m) and 50 ft (15.2 m) lengths. The blue powder coated reel is supplied with Hytrel cable which has a yellow coating. The stainless steel reels are supplied with nylon coated stainless steel cable.

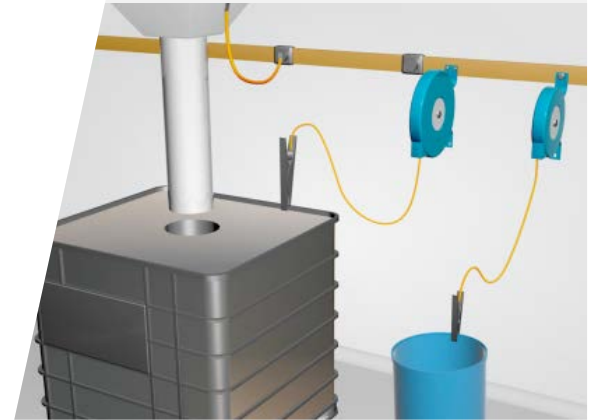

Blue powder coated retractable cables reels

Applications:	Grounding and bonding metal objects ranging from small cans to 55 gallon drums (Medium size clamp) Grounding and bonding metal objects ranging from open top 55 gallon drums to large totes and IBCs (Large size clamp)
Reel Dimensions:	7.5" x 6.1" x 2.0" (190 mm x 155 mm x 51 mm) approx.
Cable Lengths:	20 ft (6.1 m), 30 ft (9.1 m), 50 ft (15.2 m) with Hytrel coating
Cable Supplied:	Multi-stranded galvanized steel with hi-viz Hytrel yellow coating
Cable Size:	Conductor cross sectional area - 3/32" (2.3 mm) galvanized braided cable conductor 1/8" (3.2 mm) with Hytrel coating
Reel Construction:	Latchable spring mounted cable drum mounted in powder coated steel housing
ATEX / FM Reel Certification:	ATEX  II 2 G T6 (Assessed to EN 13463-1 : 2001) II 2 D FM approved (R20 & R30)



ATEX / FM / IECEx / UKEX Clamp Certification:	ATEX  II 1 GD T6 (Assessed to EN 13463-1 : 2009) Sira 02ATEX9381 ATEX Notified Body: SIRA
------------------------------------------------------	----------------------------------------------------------------------------------------------------------------------------------------------------------------------------------------------

FM Certificate of Compliance number: 3046346

IECEx
 Ex h IIC T6 Ga
 Ex h IIIC T85°C Da
 Ta = -40°C to +60°C
 IECEx EXV 20.0033
 IECEx Certified Body: ExVeritas

UKCA Ex
 II 1 G
 II 1 D
 Ex h IIC T6 Ga
 Ex h IIIC T85°C Da
 Ta = -40°C to +60°C
 ExVeritas 21UKEX0842
 UKCA Ex Approved Body: ExVeritas

Cen-Stat™

Technical Information

NG Reels 20

	<i>inch</i>	<i>mm</i>	<i>Mounting</i>
<i>A</i>	7.48	190.00	
<i>B</i>	6.10	155.00	
<i>C</i>	0.27 x 0.38	6.750 x 9.53	2 slots
<i>D</i>	5.87	149.00	
<i>E</i>	6.69	170.00	
<i>F</i>	2.00	50.80	
<i>kgs</i>		1.25	
<i>lbs</i>		2.75	

NG Reels 30

	<i>inch</i>	<i>mm</i>	<i>Mounting</i>
<i>A</i>	9.33	237.00	
<i>B</i>	7.87	200.00	
<i>C</i>	0.41	10.32	4 slots
<i>D</i>	7.87	200.00	
<i>E</i>	8.66	220.00	
<i>F</i>	2.36	60.00	
<i>kgs</i>		2.25	
<i>lbs</i>		4.95	

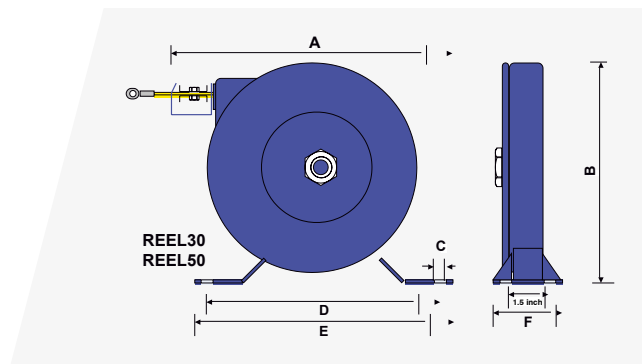
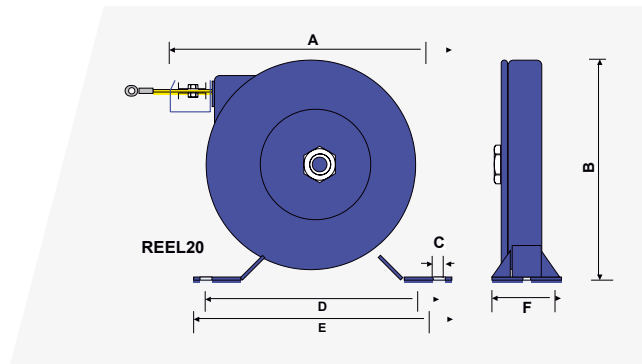

NG Reels 50

	<i>inch</i>	<i>mm</i>	<i>Mounting</i>
<i>A</i>	9.33	237.00	
<i>B</i>	7.87	200.00	
<i>C</i>	0.41	10.32	4 slots
<i>D</i>	7.87	200.00	
<i>E</i>	8.66	220.00	
<i>F</i>	2.36	60.00	
<i>kgs</i>		2.25	
<i>lbs</i>		4.95	



Cen-Stat™



R-Series stainless steel retractable cables reels

Applications:	Grounding and bonding metal objects ranging from small cans to 55 gallon drums (Medium size clamp) Grounding and bonding metal objects ranging from open top 55 gallon drums to large totes and IBCs (Large size clamp)
Reel Dimensions:	7.5" x 6.1" x 2.0" (190 mm x 155 mm x 51 mm) approx.
Cable Lengths:	20 ft (6.1 m), 30 ft (9.1 m), 50 ft (15.2 m) with Hytrel coating
Cable Supplied:	Multi-stranded stainless steel with hi-viz Hytrel yellow coating
Cable Size:	Conductor cross sectional area - 3/32" (2.3 mm) stainless steel braided cable conductor 5/32" (3.9 mm) with Hytrel coating
Reel Construction:	Latchable spring mounted cable drum mounted in stainless steel (SS grade: 304) housing
ATEX Reel Certification:	ATEX  II 2 G T6 (Assessed to EN 13463-1 : 2001)  II 2 D FM approved (R20 & R30)





ATEX / FM / IECEx / UKEX Clamp Certification:	ATEX  II 1 GD T6 (Assessed to EN 13463-1 : 2009) Sira 02ATEX9381 ATEX Notified Body: SIRA FM Certificate of Compliance number: 3046346
----------------------------------------------------------	--------------------------------------------------------------------------------------------------------------------------------------------------------------------------------------------------------------------------------------------------------

IECEx
 Ex h IIC T6 Ga
 Ex h IIIC T85°C Da
 Ta = -40°C to +60°C
 IECEx EXV 20.0033
 IECEx Certified Body: ExVeritas

UKCA Ex
 II 1 G
 II 1 D
 Ex h IIC T6 Ga
 Ex h IIIC T85°C Da
 Ta = -40°C to +60°C
 ExVeritas 21UKEX0842
 UKCA Ex Approved Body: ExVeritas

Cen-Stat™



30 m (100 ft) retractable cable reels

Applications:	Grounding and bonding metal objects ranging from small cans to 55 gallon drums (Medium size clamp) Grounding and bonding metal objects ranging from open top 55 gallon drums to large totes and IBCs (Large size clamp)
Reel Dimensions:	7.5" x 6.1" x 2.0" (190 mm x 155 mm x 51 mm) approx.
Cable Lengths:	100 ft (30 m only)
Cable Supplied:	Multi-stranded galvanized steel with hi-viz Hytrel yellow coating
Cable Size:	Conductor cross sectional area - 3/32" (2.3 mm) galvanized braided cable conductor 1/8" (3.2 mm) with Hytrel coating
Reel Construction:	Latchable spring mounted cable drum mounted in red powder coated housing Non-latchable self retracting spring mounted cable drum mounted in red powder coated housing
ATEX Reel Certification:	ATEX  II 2 G T6 (Assessed to EN 13463-1 : 2001)  II 2 D



ATEX / FM / IECEx / UKEX Clamp Certification:	ATEX  II 1 GD T6 (Assessed to EN 13463-1 : 2009) Sira 02ATEX9381 ATEX Notified Body: SIRA
------------------------------------------------------	---------------------------------------------------------------------------------------------------------------------------------------------------------------------------------------------

FM Certificate of Compliance number: 3046346

IECEX Ex h IIC T6 Ga Ex h IIIC T85°C Da Ta = -40°C to +60°C IECEx EXV 20.0033 IECEx Certified Body: ExVeritas	UKCA Ex  II 1 G  II 1 D Ex h IIC T6 Ga Ex h IIIC T85°C Da Ta = -40°C to +60°C ExVeritas 21UKEX0842 UKCA Ex Approved Body: ExVeritas
-------------------------------------------------------------------------------------------------------------------------------------	---------------------------------------------------------------------------------------------------------------------------------------------------------------------------------------------------------------------------------------------------------------------------------------------------------------------------------------

Cen-Stat™

Additional static grounding devices in the Cen-Stat™ range

VESX90 - Large size double ended clamp

Applications:	Bonding metal objects ranging from 55 gallon drums to large metal totes and IBCs
Clamp Material:	Stainless Steel (SS grade: 304)
Operating Temperature:	-40°F to +140°F (-40°C to +60°C)
Dimensions:	9.4" x 4.1" x 1.3" (236 mm x 105 mm x 33 mm)
Maximum Jaw Opening:	1.8" (30 mm) approx.
Clamp Teeth:	2 tungsten carbide teeth - set side by side in a stainless steel mounting block for extra stability
Spring:	Torsion spring (3.5 turn design) Stainless steel (SS Grade: 302)
Cable Supplied:	10 ft (3 m), 16 ft (5 m) or 32 ft (10 m) Cen-Stat spiral multi-stranded galvanized steel with orange anti-UV / static dissipative Hytel coating
Cable Size:	Conductor cross sectional area - 11 AWG (4 mm ²) approx. With Cen-Stat coating - 0.25" (6.5 mm) diameter

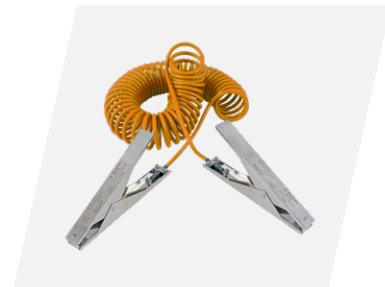

ATEX / FM / IECEx / UKEX Clamp Certification:

ATEX

 II 1 GD T6 (Assessed to EN 13463-1 : 2009)
Sira 02ATEX9381
ATEX Notified Body: SIRA

FM Certificate of Compliance number: 3046346

IECEx

Ex h IIC T6 Ga
Ex h IIIC T85°C Da
Ta = -40°C to +60°C
IECEx EXV 20.0033
IECEx Certified Body: ExVeritas

UKCA Ex

 II 1 G
II 1 D
Ex h IIC T6 Ga
Ex h IIIC T85°C Da
Ta = -40°C to +60°C
ExVeritas 21UKEX0842
UKCA Ex Approved Body: ExVeritas

Additional static grounding devices in the Cen-Stat™ range

VESX45 - Medium size double ended clamp

Applications:	Bonding metal objects ranging from small cans to 205 litre (55 gallon) drums
Clamp Material:	Stainless Steel (SS grade: 304)
Operating Temperature:	-40°F to +140°F (-40°C to +60°C)
Dimensions:	4.7" x 2.6" x 1.0" (120 mm x 65mm x 25 mm)
Maximum Jaw Opening:	0.6" (15 mm) approx.
Clamp Teeth:	2 tungsten carbide teeth - set side by side in a stainless steel mounting block for extra stability
Spring:	Torsion spring (4 turn design) Stainless steel (SS Grade: 302)
Cable Supplied:	10 ft (3 m), 16 ft (5 m) or 32 ft (10 m) Cen-Stat spiral multi-stranded galvanized steel with orange anti-UV / static dissipative Hytrel coating.
Cable Size:	Conductor cross sectional area - 11 AWG (4 mm ²) approx. With Cen-Stat coating - 0.25" (6.5 mm) diameter



ATEX / FM / IECEx / UKEX Clamp Certification:

ATEX

 II 1 GD T6 (Assessed to EN 13463-1 : 2009)
Sira 02ATEX9381
ATEX Notified Body: SIRA

FM Certificate of Compliance number: 3046346

IECEx

Ex h IIC T6 Ga
Ex h IIIC T85°C Da
Ta = -40°C to +60°C
IECEx EXV 20.0033
IECEx Certified Body: ExVeritas

UKCA Ex

 II 1 G
II 1 D
Ex h IIC T6 Ga
Ex h IIIC T85°C Da
Ta = -40°C to +60°C
ExVeritas 21UKEX0842
UKCA Ex Approved Body: ExVeritas

Copyright Notice

The website and its content is copyright of Newson Gale Ltd © 2020. All rights reserved.

Any redistribution or reproduction of part or all of the contents in any form is prohibited other than the following:

- you may print or download to a local hard disk extracts for your personal and noncommercial use only
- you may copy the content to individual third parties for their personal use, but only if you acknowledge the website as the source of the material

You may not, except with our express written permission, distribute or commercially exploit the content. Nor may you transmit it or store it in any other website or other form of electronic retrieval system.

Right to change

This document provides general information only and may be subject to change at any time without notice. All information, representations, links or other messages may be changed by Newson Gale at any time without prior notice or explanation.

Newson Gale is not obliged to remove any outdated information from its content or to expressly mark it as being outdated. Please seek the advice of professionals as necessary regarding the evaluation of any content.

Disclaimer of liability

The information provided in this Datasheet is provided by Newson Gale without any representations or warranties, expressed or implied, as to its accuracy or completeness. The liability of Newson Gale for any expenses, losses or actions incurred whatsoever by the recipient as a result of the use of this Datasheet shall be excluded.

Leading the way in hazardous area static control



www.newson-gale.com

10/10

United Kingdom
Newson Gale Ltd
Omega House
Private Road 8
Colwick, Nottingham
NG4 2JX, UK
+44 (0)115 940 7500
groundit@newson-gale.co.uk

United States
IEP Technologies LLC
417-1 South Street
Marlborough, MA 01752
USA
+1 732 961 7610
groundit@newson-gale.com

Deutschland
IEP Technologies GmbH
Kaiserswerther Str. 85C
40878 Ratingen
Germany
+49 (0)2102 58890
erdung@newson-gale.de