

OMNTEC[®] Mfg., Inc.

1993 Pond Rd., Ronkonkoma, NY 11779 Tank Gauging • Liquid Level and Leak Detection Systems • Relays

OEL8000II Installation Manual

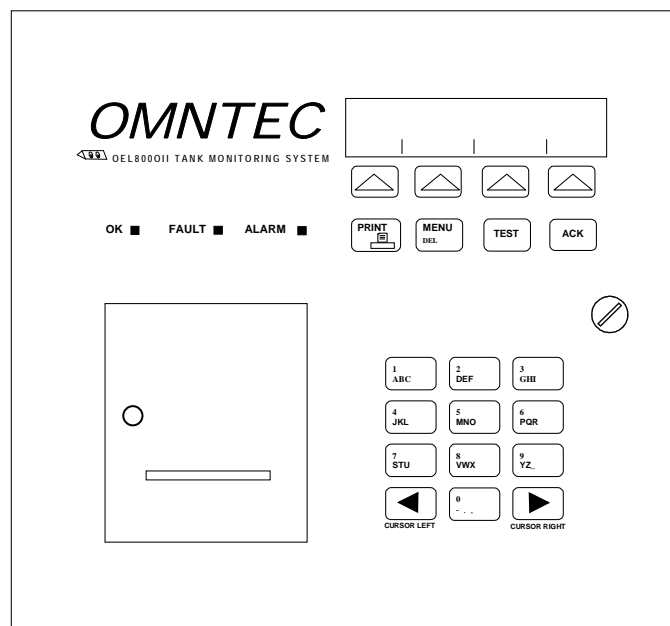

Version 5.33E August 2006

Don't VOID Your Warranty!

Warranty will be void if OMNTEC[®] EC-2 (Belden#8761) cable is not used with MTG-series probe.

To **initiate** the **warranty** the warranty card provided with this manual must be completed and returned.

**MTG PROBES MUST USE
BELDEN#8761 OR
OMNTEC[®] EC-2 CABLE.**

**LEAK SENSORS CAN
USE EQUIVELANT TO
OMNTEC[®] EC-4 OR
BELDEN#9940.**



PROPRIETARY INFORMATION NOTICE

This document contains information and material developed by OMNTEC® Mfg., Inc.
All rights are reserved.

No part of this document may be reproduced, transmitted, processed or recorded by any means or form, electronic, mechanical, photographic or otherwise, without the express written consent of OMNTEC® Mfg., Inc.

Printed in the United States of America

© Copyright 2007 OMNTEC® Mfg., Inc.

NOTICE

Use of unauthorized parts in the OEL8000II system or modification to any parts of the system will nullify U.L. listing and our warranty. OMNTEC® Mfg., Inc. will not be responsible for any liability claims arising from the performance of modified units.

If you have any questions, please contact OMNTEC® Mfg., Inc. at (631) 981-2001.

OMNTEC LIMITED WARRANTY

The seller, OMNTEC Mfg., Inc. warrants to buyer that product is free of defects when properly installed and maintained by user. Warranty period is one year from date of installation or 15 months from date of shipment from factory, whichever occurs first. The seller's sole obligation is to repair or replace parts found to be defective upon evaluation by OMNTEC. Parts can be returned for evaluation by requesting an RMA (Return Material Authorization) from OMNTEC. The liability of the seller shall not exceed the price paid for components found to be defective. The above warranty is exclusive of all other warranties whether implied or expressed. Seller assumes no obligation for special or indirect damages incurred by user.

OMNTEC warranty for custom probes, custom controllers, add ons, spare or replacement parts is for 90 days from date of shipment. All items must be properly installed for warranty to be valid. Any items found to have factory defects after evaluation by OMNTEC through return material authorization process, will be repaired or replaced. The liability of seller shall not exceed price paid for item found to be defective by factory evaluation. The above warranty is exclusive of all other warranties whether implied or expressed. OMNTEC assumes no responsibility or obligation for special or indirect damages incurred by user.

Table of Contents

READ THIS FIRST!	XIII
SECTION 1 OVERVIEW	1-1
1.1 SYSTEM DESCRIPTION	1-1
1.2 SAFETY	1-1
1.3 UNPACKING, INSPECTION AND DAMAGE CLAIMS	1-2
1.4 RETURNS	1-3
1.5 ELECTRICAL WIRING	1-3
1.5.1 Wires and Cables.....	1-3
1.5.2 Conduits	1-4
SECTION 2 EQUIPMENT	2-1
2.1 CONTROLLER.....	2-1
2.1.1 Preparation	2-1
2.1.2 BX-Series Sensor Worksheet	2-2
2.1.3 Tank Tilt	2-2
2.2 CONTROLLER INSTALLATION	2-3
2.2.1 Mounting the Controller.....	2-4
2.2.2 Wiring and Controller Knockout Designations	2-4
2.2.3 Junction Boxes.....	2-5
2.2.4 EYS Seal Off Fitting	2-5
2.2.5 AC Power Line	2-6
2.2.6 Telephone Connections at the Controller.....	2-6
2.2.7 AC Power Connections at the Controller.....	2-6
2.2.8 Main Panel and Sub-Panel Grounding	2-7
2.3 MAGNETOSTRICTIVE (MTG) PROBE.....	2-7
2.3.1 MTG Probe Length.....	2-8
2.3.2 Riser Pipe for MTG Probe	2-8
2.3.2.1 Riser Pipe Minimum Length Requirements.....	2-9
2.3.2.2 Riser Pipe Maximum Length Requirements	2-9
2.3.3 MTG Probe Installation	2-10
2.3.4 MTG Probe Field Wiring	2-10
2.3.4.1 Probe Cable	2-11
2.3.4.2 MTG Probe Connections at the Controller	2-11
2.4 SENSORS.....	2-12
2.4.1 Sensor Cable.....	2-13
2.4.2 BX-PDWF Sensor.....	2-13
2.4.2.1 Riser Pipe for BX-PDWF	2-14
2.4.2.2 BX-PDWF Installation	2-15
2.4.3 BX-PDWS.....	2-16
2.4.3.1 Riser Pipe for BX-PDWS	2-16
2.4.3.2 BX-PDWS Installation	2-17
2.4.4 BX-PDS	2-17
2.4.5 BX-L12, BX-L20, BX-LV Series.....	2-19
2.4.5.1 Riser Pipe for BX-L12, BX-L20, BX-LV Series	2-19
2.4.5.2 BX-L12, BX-L20, BX-LV Installation.....	2-19
2.4.6 BX-LM* Series	2-20
2.4.6.1 Riser Pipe for BX-LM* Series.....	2-20
2.4.6.2 BX-LM* Installation	2-20
2.4.7 BX-RES.....	2-21
2.4.7.1 Riser Pipe for BX-RES.....	2-22

2.4.7.2	BX-RES Installation	2-22
2.4.8	<i>BX-LS</i>	2-23
2.4.9	<i>BX-LSR</i>	2-24
2.4.10	<i>BX-LWF</i>	2-24
2.4.10.1	Riser Pipe for BX-LWF	2-24
2.4.10.2	BX-LWF Installation	2-25
2.4.11	<i>BX-TC</i>	2-25
2.4.12	<i>BX-VS</i>	2-27
2.4.13	<i>FIELD WIRING</i>	2-27
2.5	ANNUNCIATORS (RAS SERIES)	2-28
2.5.1	<i>Mounting the Annunciator</i>	2-29
2.5.2	<i>Wiring for Annunciators</i>	2-29
2.5.3	<i>Wiring Configuration for Annunciators</i>	2-30
2.5.4	<i>Annunciator Connections at the Controller</i>	2-31
2.6	INTERFACE BOARDS (IB-SERIES)	2-32
2.7	REMOTE COMMUNICATIONS	2-33
SECTION 3	APPLYING POWER	3-1
3.1	PREPARATIONS	3-1
3.2	CHECKLIST	3-1
3.3	SYSTEM START-UP CHECKLIST	3-2
3.4	CONNECTING POWER	3-3
SECTION 4	PROGRAMMING	4-1
4.1	PREPARATION	4-1
4.2	PROCEDURE	4-2
4.2.1	<i>LCD Display</i>	4-2
4.2.2	<i>Tactile Keypad</i>	4-2
4.2.3	<i>Printer</i>	4-3
4.3	PROGRAMMING PROCEDURES	4-3
4.3.1	<i>Entering the SETUP Mode</i>	4-5
4.3.2	<i>Entering the Security Code</i>	4-5
4.3.3	<i>Location Data</i>	4-8
4.3.3.1	Site Name	4-8
4.3.3.2	New Security Code	4-9
4.3.3.3	Preprogrammed Data	4-9
4.3.3.4	Site Address Line 1	4-10
4.3.3.5	Site Address Line 2	4-10
4.3.3.6	Site City	4-10
4.3.3.7	Site State	4-11
4.3.3.8	Site Zip Code	4-11
4.3.3.9	Site Phone Number	4-11
4.3.3.10	Site Manager's Name	4-12
4.3.3.11	Site Identification Number	4-12
4.3.3.12	Site Print Header	4-12
4.3.3.13	CITLD Enable Code	4-13
4.3.3.14	Ullage Percentage	4-13
4.3.4	<i>Tank Data</i>	4-14
4.3.4.1a	Copying Tank Data	4-14
4.3.4.1b	Tank Identification	4-16
4.3.4.2	Level Probe – Enable/Disable	4-16
4.3.4.3	Product Type	4-17
4.3.4.4	Coefficient of Thermal Expansion	4-17
4.3.4.5	Tank Tilt	4-18
4.3.4.6	Product Height	4-18
4.3.4.7	Water Height	4-19
4.3.4.8	Thermistor Type	4-20
4.3.4.9	Probe Wire Speed	4-20
4.3.4.10	High Water Alarm Point	4-21

4.3.4.11	Low/Low Product Alarm Point.....	4-21
4.3.4.12	Delivery Needed Alarm Point.....	4-22
4.3.4.13	Low Product Point.....	4-22
4.3.4.14	High Product Point.....	4-22
4.3.4.15	High Product Warning Point.....	4-23
4.3.4.16	Overfill Product Alarm Point.....	4-23
4.3.4.17	High/High Product Alarm Point.....	4-23
4.3.4.18	Tank Diameter.....	4-23
4.3.4.19	Probe Length.....	4-24
4.3.4.20	Tank Capacity.....	4-24
4.3.4.21	Volume Offset.....	4-24
4.3.4.22	Automated VLD (Volume Leak Detection Test).....	4-25
4.3.4.23	Sudden Loss Limit.....	4-27
4.3.4.24	Table Size.....	4-27
4.3.5	<i>Sensor Data</i>	4-28
4.3.5.1	Config (Sensor) Submenu.....	4-30
4.3.5.1.1	<i>Sensor Labeling</i>	4-31
4.3.5.1.2	<i>Other Label</i>	4-34
4.3.5.1.3	<i>Editing Sensor Labels</i>	4-35
4.3.5.1.4	<i>Temperature Sensor Programming</i>	4-37
4.3.5.1.5	<i>Vapor Sensor Programming</i>	4-38
4.3.5.2	Test/Del (Sensor) Submenu.....	4-41
4.3.5.2.1	<i>Testing and Deleting Sensors</i>	4-41
4.3.5.2.2	<i>Setting Sensor Priority</i>	4-43
4.3.6	<i>Clearing Logs (Alarm, Drop, CITLD, and VLD)</i>	4-45
4.3.7	<i>Shift Data</i>	4-46
4.3.8	<i>Remote Data</i>	4-48
4.3.8.1	Site Alarm Acknowledge Time.....	4-49
4.3.8.2	Remote Horn Timeout.....	4-49
4.3.8.3	Remote Horn Time Enable/Disable.....	4-50
4.3.9	<i>Comm</i>	4-51
4.3.9.1	Serial.....	4-51
4.3.9.1.1	<i>COM1</i>	4-52
4.3.9.1.2	<i>COM2</i>	4-53
4.3.9.1.3	<i>COM3</i>	4-56
4.3.9.2	Modem.....	4-57
4.3.9.2.1	<i>Autofax and Datamodem</i>	4-58
4.3.9.2.2	<i>Ip Modem</i>	4-60
4.3.9.3	RS485.....	4-60
4.3.10	<i>Int Brd</i>	4-61
4.3.10.1	Programming the IB-RB2 Relay Board.....	4-62
4.3.10.1.1	<i>Tank Activation</i>	4-64
4.3.10.1.2	<i>Sensor Activation (non-product distinguishing)</i>	4-65
4.3.10.1.3	<i>Sensor Activation (product distinguishing)</i>	4-65
4.3.10.1.4	<i>Temperature (BX-TC) Sensor Activation</i>	4-66
4.3.10.2	Programming the IB-C420 Board.....	4-67
4.3.10.3	Programming the IB-12V Low Voltage Board.....	4-68
4.3.10.4	Programming the IB-NET Board.....	4-68
4.3.11	<i>Report</i>	4-68
4.3.12	<i>Units</i>	4-69
4.3.13	<i>Language</i>	4-70

SECTION 5 PROCEDURES 5-1

5.1	LOOPBACK TEST.....	5-1
5.2	SETTING PRODUCT AND WATER HEIGHT (CALIBRATION).....	5-1
5.3	ON DEMAND VLD TESTING.....	5-1
5.4	REMOTE TESTING OF RAS ANNUNCIATOR.....	5-1
5.5	REPLACING CONTROLLER BATTERIES.....	5-1
5.6	TROUBLESHOOTING SENSORS.....	5-2
5.6.1	<i>Condition #1</i>	5-2

5.6.2	Condition #2.....	5-2
5.7	TROUBLESHOOTING PROBE GUIDE.....	5-3
5.7.1	Condition #1 – Status: High Water.....	5-3
5.7.2	Condition #2 – Status: Timeout Error on all Probes.....	5-4
5.7.3	Condition #3 – Status: Timeout Error on one Probe.....	5-4
5.7.4	Condition #4 – Status: Incorrect Product Level.....	5-5
5.8	PROGRAMMING CLD.....	5-8
APPENDIX A	PROBES.....	A-1
APPENDIX B	SENSORS.....	B-1
APPENDIX C	CONNECTOR SEALING KITS.....	C-1
APPENDIX D	OEL8000II CONTROLLER.....	D-1
APPENDIX E	REMOTE ANNUNCIATOR.....	E-1
APPENDIX F	INTERFACE BOARDS.....	F-1
APPENDIX G	MODEM.....	G-1
APPENDIX H	NYC FIRE DEPT. CONDITIONS OF APPROVAL.....	H-1

Read This First!

The OEL8000II has been designed using intrinsically safe principals and is Underwriters Laboratories (U.L.) listed, CUL listed, and CE listed for petroleum storage tanks. It is approved for Class I, Groups C and D or Class I, Zone 0, Group IIB Hazardous locations when connected in accordance with control drawing number CDOEL8000II.



All work must be performed only by authorized personnel who are qualified using intrinsically safe design principles (NEC procedures) and are thoroughly familiar with the OEL8000II Installation Manual. At a minimum, it is the installer's responsibility to be familiar with and to comply with intrinsic design principles as defined in the *National Electrical Code*. It is also the installer's responsibility to be familiar with and to comply with applicable local codes.

Improper wiring or installation can compromise the intrinsically safe design of the system and create an electric shock or explosion hazard. YOU CAN CAUSE DEATH OR SERIOUS PERSONAL INJURY TO YOURSELF AND OTHERS AND EXTENSIVE PROPERTY DAMAGE.



Observe the following rules. Failure to do so will create an electric shock or explosion hazard that can result in death, personal injury, or property damage.

1. Do not permit unauthorized personnel to install or service the equipment.
2. Power to the controller must be removed before installing or servicing the equipment.

IMPORTANT SENSOR INFORMATION

**ONLY INSTALL BX-SERIES SENSORS
WITH THE OEL8000II**

*Please verify sensors have been installed according to the
worksheet provided before calling technical support.*

Don't VOID Your Warranty!

Warranty will be void if OMNTEC EC-2 (Belden #8761) cable is not used with MTG-series probes.

READ ME!

Earth Ground Warning

The earth ground terminal must be connected to maintain intrinsic safety as well as UL and NEC.

READ ME!

Use Proper Knockouts

If preformed knockouts are not used, warranty will be void.

Please verify sensors have been installed according to the worksheet provided before calling technical support.

Section 1 Overview

1.1 System Description

The OMNTEC OEL8000II is a comprehensive tank gauging and leak detection system designed to bring tank owners into compliance with EPA regulations. It provides real time simultaneous monitoring of up to eight tanks, identifying water and product levels as well as leaks in single or double-wall steel and fiberglass tank systems. Up to forty-four Bright Eye series leak and level detection sensors can be added for monitoring interstitial spaces, piping sumps, double wall piping, dispenser pans, dikes, and observation wells. Alarm conditions are identified by the controller and optional low voltage remote high level annunciators. An additional option features independently programmable relays that can be used for automatically shutting down pumps and/or dispensers upon detection of a leak, low product level, or high product level. The OEL8000II also provides a user friendly inventory management system for identifying usage and alerting the customer to low inventory.

The system consists of a controller that is wall mounted in a non-hazardous location and a combination of probes and sensors for monitoring water and product levels, temperatures, and leaks. System programming and status reporting are achieved via the controller. Remote communication capability can be provided by an internal 14,400 baud fax / modem, RS232, RS485, 4-20 mA card, IB-NET card (internet) or relay outputs. Easy to read status and inventory data is provided on the controller's LCD display while a hard copy can be obtained from the 36 character thermal printer. Reporting is programmable or available on demand.

The OMNTEC OEL8000II is an intrinsically safe system and is Underwriters Laboratories listed for petroleum storage tanks. Refer to third party certifications for performance specifications.



1.2 Safety

To install or service any component of the OEL8000II system the individual must be qualified using intrinsically safe design principles (NEC practices) and must be familiar with the specifications and procedures described within this manual. It is the responsibility of the installer and operator to be familiar with and to comply with all codes and regulations. Before you begin, read *Section 3 – Applying Power*. When you have finished, return to the beginning, and read the entire manual. The following are some safety tips to be used during installation and servicing:

- ◆ **Do not** perform any installation or service procedures if you are not qualified to work with intrinsically-safe systems.
- ◆ **Do not** perform any installation or service procedures if you are not familiar with the National Electrical Code and all other federal, state, and local codes and regulations pertaining to this installation.
- ◆ **Do not** perform any installation or service procedures until you have read through and understand this **entire** manual.
- ◆ **Do not** install the controller in a hazardous location.
- ◆ **Do not drill** through enclosure
- ◆ **Do not** mount outdoors without ENC-4X weather proof enclosure
- ◆ **Do not** install RAS series remote Annunciators in hazardous locations.
- ◆ **Only** sensors and probes are to be installed within hazardous locations.
- ◆ **Do not** substitute components. The intrinsic safety design can become compromised creating an explosion hazard. It will also void the warranty.
- ◆ **Do not** apply power to the controller until all of the other installations and wiring have been completed and inspected. Read **Section 3 – Applying Power**. Applying power to the controller and programming the controller are the **final** steps in the installation process.
- ◆ **Always remove power** to the controller before servicing.
- ◆ Take all safety precautions to avoid accidents.
- ◆ Keep work area clean.
- ◆ Block off work area when working on tanks and hazardous locations to prevent vehicles and pedestrians from entering the area.
- ◆ Use proper fire prevention measures to keep all sparks, flames, and other ignition devices away from the hazardous area.

1.3 Unpacking, Inspection and Damage Claims

Unpack and thoroughly inspect all equipment before accepting receipt from carrier. If you detect or suspect any damage or loss, do the following:

- ◆ Write a detailed description of the damage or loss on the front of the bill of lading and sign it.
- ◆ Have the carrier's agent sign the bill of lading.
- ◆ Immediately notify the carrier by phone and follow up in writing within 48 hours.

The buyer assumes all risk for damage or loss of merchandise incurred during shipping and is responsible for filing and settling any claims. If you report your loss to OMNTEC® Mfg., Inc. however, we will attempt to assist you with your claim.

1.4 Returns

You must obtain a Return Material Authorization (RMA) from OMNTEC® Mfg. before returning shipments. Shipments that are returned without such authorization will be rejected. It is also your responsibility to pre-pay all freight charges for returned material. Material for which an RMA has been provided may be shipped to:

OMNTEC Mfg., Inc. 1993 Pond Road Ronkonkoma, New York 11779 RMA# _ _ _ _ _

NOTE: RMA # MUST APPEAR ON SHIPPING LABEL

1.5 Electrical Wiring

Do not apply power to the controller until you have read and complied with Section 3 – Applying Power. All electrical work should be performed by qualified personnel only and in accordance with the National Electrical Code and all federal, state, and local codes and regulations as pertains to this installation.



Failure to comply can create an electric shock or explosion hazard causing death, personal injury, or property damage.



Failure to make electrical splices, conduits, and junction boxes water-tight can result in system failure due to wet wires.

1.5.1 Wires and Cables

Observe the following when selecting and installing wires and cables:

- ◆ Run one four conductor cable for each sensor buss (see *Section 2.4.1 – Sensor Cable*).
- ◆ Up to twenty-two sensors may be connected to one buss
- ◆ Two or more probes **may not** be combined into a single cable (see *Section 2.3.4 – MTG Probe Field Wiring*).
- ◆ Probes and sensors **may not** be combined into a single cable
- ◆ Splice sensor wires using the SK-4 connector sealing kit

- ◆ Splice probe wires using the SK-4 connector sealing kit
- ◆ Probe cables and sensor cables must be completely enclosed in conduit from the junction box to the console (contact factory for direct burial applications)
- ◆ Probe and sensor cables may share the same conduit
- ◆ Probe and sensor cables must be run in conduits that are separate from other wiring.
- ◆ All wiring must enter the controller through the designated preformed knockouts (see *Appendix D – OEL8000II Controller*).



Failure to comply can create an electric shock or explosion hazard causing death, personal injury, or property damage.

Note: Direct burial wiring is available. Contact manufacturer.

1.5.2 Conduits

Base the location and number of conduits required for the installation on the number and diameter of the probe and sensor cables. Use a junction box inside the building to combine the cables as described below. **Observe the applicable codes pertaining to which cables may or may not be combined into a single conduit.**

You must have separate conduits as follows:

- ◆ 120 VAC Power cables must be combined in a separate (isolated) conduit.
- ◆ All Annunciator (RAS series) cables must be combined in a separate (isolated) conduit.
- ◆ MTG Probe and Sensor cables may share a separate (isolated) conduit.
- ◆ RS-232, RS485, and Telephone cables may share a separate (isolated) conduit.
- ◆ Alarm relay cables must be combined in a separate (isolated) conduit

Use and select the proper conduit types and sizes in accordance with applicable codes. Even in situations where they are not required by code, it is recommended that they be used to protect wiring.

Note: Make certain that all conduits and junction boxes are dry and watertight. Wet wires can result in the faulty operation of the system.

Observe the following when selecting and installing conduit:

- ◆ Determine the conduit size based on the number and size of cables it will carry.
- ◆ Plan the conduit installation so that the junction box in the manway will not become submerged in water after a heavy rain.

- ◆ Rigid metal conduit, 3/4 inch or larger (use reducer coupling, do not drill into box) is recommended between the controller and the tank area.
- ◆ Do not combine probe and sensor cables with other wires in the same conduit.
- ◆ Install the conduit seal fittings in accordance with NFPA 70 (National Electrical Code) and NFPA 30 (Automotive and Marine Station Code).
- ◆ All wires should enter the controller via a conduit.
- ◆ Immediately after 3 ft from panel, be sure to allow 3 ft between sensor cable conduit and any other high voltage (120V or higher) or communications conduit.



Failure to comply can create an electric shock or explosion hazard causing death, personal injury, or property damage.

Section 2 Equipment

2.1 Controller

The OEL8000II's controller is mounted in a non-hazardous area and requires 100-240 VAC, 50/60 Hz, 60 watts. It monitors all probes and sensors providing status and alarm information on its LCD display or thermal printer. The controller can be programmed to respond to an alarm condition by activating alarm relays that can automatically shut off power to one or more pumps and/or dispensers. The OEL8000II has the capability of communicating alarm conditions and inventory status to a remote terminal or central station using an internal fax/modem, IB-NET card (internet), RS232, RS485, C4-20 or relay outputs. Audio/visual remote alarms (RAS series) can be connected to the controller as well.

Note: Alarm relays, RAS series remote annunciators, and remote communication are optional equipment.

2.1.1 Preparation

Perform the following steps before beginning construction or installation:

1. Inspect all of the parts for shipping damage.
2. Review *Section 3 – Applying Power*.
3. Determine all of the conduit paths, probe and sensor installation locations, and controller and annunciator mounting locations.
4. Review the programming instructions, and prepare the required data in advance of programming the controller. (see *Appendix B – Sensors*).
5. Review the National Electrical Code and the federal, state, and local codes applicable to this installation to ensure compliance.

Do not apply power to the controller until all of the other installations and wiring have been completed. Consult *Section 3 – Applying Power*.



Failure to comply can create an electric shock or explosion hazard causing death, personal injury, or property damage.

2.1.2 BX-Series Sensor Worksheet

If your system is using BX-series sensors, a sensor worksheet **must** be completed. The information on this worksheet will be required when programming your system. (see *Appendix B – Sensors*).

Note: For factory programmed systems, this worksheet was previously completed and provided to customer.

2.1.3 Tank Tilt

When programming the controller, specific tank characteristics, measurements, and the calculated tilt for each tank must be entered. This section identifies the required data and the procedure for calculating the tank tilt. Tank tilt measurements are not required if the MTG probe is mounted in the center of the tank or if the tank is level.

Refer to Figure 2-1 and perform the measurements and calculations described in this section for each tank. This procedure will provide the tank tilt, which you will have to program into the controller (see *Section 4.3.4.5 – Tank Tilt*).

Note: Make certain that there is liquid in the tank before beginning. This procedure cannot be performed on an empty tank.

1. Measure the distance from the center of the fill riser opening to the center of the probe riser opening in inches. Enter the value as follows:

$$P = \underline{\hspace{2cm}} \text{ (inches)}$$

2. Calculate the midpoint on the tank by measuring the tank length and dividing it by 2.
3. Locate the midpoint on the tank by carefully measuring from one end of the tank to the distance calculated in Step 2.
4. Measure the distance from the center of the opening where the probe will be located to the tank midpoint that was determined in Step 3. Enter the value as follows:

$$M = \underline{\hspace{2cm}} \text{ (inches)}$$

5. Measure the liquid level at each opening. Subtract liquid level at probe riser from liquid level at fill riser, (Fill level – Probe level = D).

Note: When the liquid level at the probe riser is higher than liquid level at the fill riser, D is a negative value and must be entered as such.

$$D = \underline{\hspace{2cm}} \text{ (inches)}$$

6. Calculate the tank tilt using the following equation:

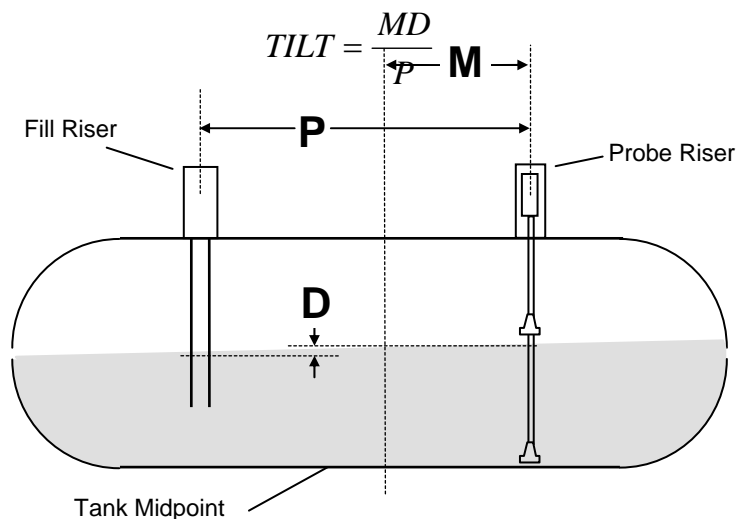

Fig. 2-1: Tank Tilt Calculation

2.2 Controller Installation

Observe the following installation requirements:

- ◆ Locate the controller indoors, **in a non-hazardous**, protected location.
- ◆ Locate controller at eye level, where it is easily accessible, and its alarms will be heard.
- ◆ Locate the controller in a dry area (avoid sweating or leaking pipes and areas where rain can enter).
- ◆ Locate the controller in areas where temperatures will stay between 20°F and 140°F (-7°C and 60°C).
- ◆ It is recommended that the controller be mounted on an inside wall that is close to where the conduits will be entering the building so as to ease installation.
- ◆ Use proper anchor bolts for wall type.
- ◆ Allow 6" clearance on the top and sides of the controller for air circulation.
- ◆ Make certain that there is sufficient clearance for opening the controller door.
- ◆ Allow for sufficient clearance around the controller for conduit access. All conduits will enter the controller through the designated preformed knockouts. (see *Appendix D – OEL8000II Controller*).
- ◆ Avoid installing in corners.
- ◆ Avoid swinging doors that can bang into the panel.

2.2.1 Mounting the Controller

The controller is mounted on the wall using the mounting flange. Do not attempt to remove the motherboard or any internal components (printed circuit board) in order to mount the panel from the inside.

1. Place the panel against the wall and use it as a template.
2. Install proper anchors and bolts for wall type.

Note: Drilling any holes in the controller will void warranty.

2.2.2 Wiring and Controller Knockout Designations

All wiring must be performed in accordance with Control Drawing No. CDOEL8000II. Before making any connections inside the panel, refer to the following drawings in *Appendix D – OEL8000II Controller*:

- ◆ Control Drawing No. CDOEL8000II (required for installation)
- ◆ Intrinsically Safe Barrier Cover
- ◆ Components and Connections
- ◆ Power Supply Connections

All wiring enters the controller via conduit through the designated preformed knockouts as shown in Figure 2-2. You **must** adhere to the following wiring requirements, failure to do so will void warranty:

- ◆ K-1 and K-2 knockouts are reserved for the controller's AC power line. **AC input must come in tight and not contact the IS cover. The cover must be able to open freely.**
- ◆ K-3, K-4, K-5 and K-6 are reserved for the sensor and probe cables only.
- ◆ Relay and option board wires enter the controller through K-7, K-8 or K-9.
- ◆ The RJ11 telephone knockout port for modem option is located at K10.
- ◆ The 9 pin RS-232 communications port is located on the left side panel.
- ◆ An additional 9 pin D communications knockout is located at K11.



Failure to comply will defeat the intrinsically safe design of the system and will create an explosion hazard. Consult the National Electrical Code pertaining to voltage and wire specification requirements for merging wires into the same conduit.

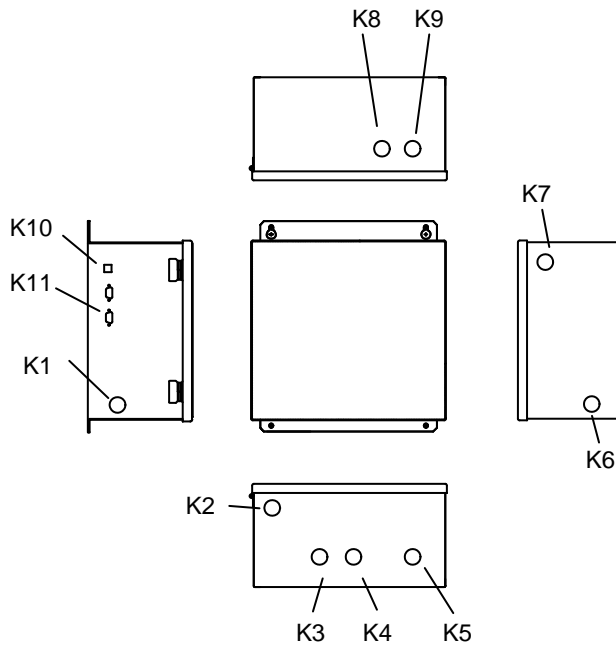

Fig. 2-2: Panel Knockouts for Conduit Circuitry

Note: K-3 through K-6 lead to intrinsically safe circuit location, (see Appendix D – OEL8000II Controller).

2.2.3 Junction Boxes

Mount waterproof junction boxes in manways so as to provide access to probe and sensor connections after installation.

Note: Make certain that all conduits and junction boxes are dry and watertight. Wet wires can result in the faulty operation of the system.

Observe the following when selecting and installing junction boxes:

- ◆ Use waterproof junction boxes inside each manway.
- ◆ Junction box size should meet code requirements.
- ◆ Mount the junction box in each manway so that it will not become submerged in water after a heavy rain.

2.2.4 EYS Seal Off Fitting

Consult National Electrical Code and other applicable codes for EYS installation. Make installations as follows:

- ◆ Install EYS Seal-Off fittings in accordance with applicable codes.
- ◆ Prior to applying appropriate sealing compound in all EYS, be sure entire system is functioning properly.

2.2.5 AC Power Line

The AC power line will run from the control panel directly to a 15 Amp circuit breaker within a circuit breaker panel via conduit. **Select wire in accordance with code for this installation.**

Note: To maintain the intrinsically safe design principles and UL requirements, the field ground and earth ground must be installed properly (see Appendix D – OEL8000II Controller).

2.2.6 Telephone Connections at the Controller

The OEL8000II can be used with a line sharing device; consult factory for details. Do not use any extensions or services such as *Call Waiting*. These features can interrupt communications.

Bring the telephone cable to the controller via conduit and connect to the RJ11 jack located on the left side of the controller (see *Appendix D – OEL8000II Controller*).

All other remote communications devices (i.e., RS232 and RS485) should be connected to the OEL8000II using a 9 pin female or male connector. The remote communications ports are located on the left side panel of the controller (see Figure 2-2).

2.2.7 AC Power Connections at the Controller

The controller requires its own dedicated circuit. Bring the AC power line into the panel via the conduit knockout K-1 or K-2 as shown in Figure 2-2. Make the following connections inside the controller (see *Appendix D – OEL8000II Controller*):

1. Connect the line voltage wire to the **L** terminal.
2. Connect the neutral wire to the **N** terminal.
3. Connect the field ground wire to the **F.G.** terminal. Refer to *Section 2.2.8 – Main Panel and Sub-Panel Grounding* for main panel grounding.
4. Connect the earth ground wire to the chassis ground lug.

AC input must come in tight and not contact the IS cover. The cover must be able to open freely.

Bring the other end of the AC power line into the circuit breaker panel and connect to a 15 Amp circuit breaker.



Electric Shock Hazard. Make certain that the circuit breaker is in the OFF position. Avoid touching other lines. Failure to comply can result in an electric shock causing death or personal injury.

2.2.8 Main Panel and Sub-Panel Grounding

Pull the wire through the rigid metal conduit and connect it directly to the ground bar of the **main** electrical service panel, not a sub-panel. Do **not** rely on the metal conduit as ground. See *Appendix D – OEL8000II Controller* for sub-panel wiring instructions.

2.3 Magnetostrictive (MTG) Probe

The magnetostrictive probe is made of a 316 grade stainless steel shaft with floats compatible with the tank contents. It is used to monitor water and tank product levels. To verify float compatibility contact manufacturer with the system serial number. In addition, it contains up to six internal sensors for monitoring temperature. MTG-probes are rated for Class I, Group D, Hazardous locations when connected in accordance with control drawing no. CDOEL8000II. Probe specifications, drawings, installation information, and related data are provided in *Appendix A – Probes*.

During normal operation, the probe will cause conditions to occur as follows:

- ◆ High/High Level Alarm – occurs when the product level in the tank reaches an emergency height during a fill condition. The factory default value is 90%, but this can be adjusted up to 95%.
- ◆ Overfill Alarm – similar to High/High Level Alarm. It is factory disabled but can be enabled by the end user, and the trigger can be set at any level up to 90%.
- ◆ High Warning – occurs when the product level in the tank reaches the programmed high warning level.
- ◆ High Product Level – occurs when the product in the tank rises to the programmed high product level. This is a setpoint that can be used to initiate a programmed response such as triggering a relay. It is not a warning or an alarm.
- ◆ Low Product Level – occurs when the product in the tank drops to the programmed low product level. This is a setpoint that can be used to initiate a programmed response such as triggering a relay. It is not a warning or an alarm.
- ◆ Delivery Needed Alarm – occurs when the product level has dropped to a level at which point a delivery is needed.
- ◆ Low/Low Level Alarm – programmable feature, occurs when the product level in the tank drops to a critical level.
- ◆ High Water Alarm – programmable feature, it occurs when the water level in the tank is too high.

- ◆ Sensor Alarm – occurs when a leak has been detected or there is no communication with sensor.
- ◆ Sudden Loss Alarm – occurs during VLD testing indicating a large loss that is not consistent with a leak (e.g., pumping gas while test is in progress).

When wired in accordance with Control Drawing No. CDOEL8000II (see *Appendix D – OEL8000II Controller*), each OEL8000II controller can monitor up to eight magnetostrictive probes (KOEL8000II kits monitor up to four magnetostrictive probes). The probes are rated for Class I, Group D, Hazardous locations.

2.3.1 MTG Probe Length

Before installing the MTG probe, measure and record the **Probe Shaft Length**. This information will be required when programming the controller. Measure from the bottom of the lower spacer bracket to the bottom of the shaft (see Figure 2-3).

Do not approximate length. Extreme accuracy is required to ensure proper operation.



Incorrect measurements will result in improper system operation.

2.3.2 Riser Pipe for MTG Probe

1. Install a riser as close as possible to the center of the tank. This location is necessary in order to minimize the effect of the tank tilt.
2. The riser pipe must be:
 - ◆ 4 inch NPT
 - ◆ made of ANSI schedule 40 pipe
 - ◆ threaded on both sides

Note: For 2 and 3- inch openings or flanged applications consult OMNTEC Mfg., Inc.

Installation of probes and sensors often requires that a riser be installed first. It is necessary that the installer be familiar with and adheres to applicable federal, state and local codes pertaining to riser installation.

The following procedures are used for determining the minimum and maximum length requirements for the riser.

2.3.2.1 Riser Pipe Minimum Length Requirements

1. Add 2.5 inches to the probe length (see *Section 2.3.1 – MTG Probe Length*) for cable connector assembly.
2. Measure the diameter of the tank.
3. Subtract the tank diameter in Step 2 from the value calculated in Step 1.
4. Add 6 inches to the calculation in Step 3. This is the minimum riser length.

Example for calculating the minimum length of the riser for an MTG probe:

If the overall MTG probe length is 107.5 inches and the tank diameter is 80 inches, you would do the following calculation:

$$107.5 \text{ inches} + 2.5 \text{ inches} = 110 \text{ inches}$$

$$\begin{array}{r} 110 \text{ inches} \\ - 80 \text{ inches} \\ \hline 30 \text{ inches} \end{array}$$

$$\begin{array}{r} 30 \text{ inches} \\ + 6 \text{ inches} \\ \hline 36 \text{ inches} \end{array}$$

Therefore, 36 inches would be the minimum length of the (MTG Probe) riser for this example.

The additional six (6) inches is required to compensate for tank deflection.



Failure to provide for tank deflection can result in damage to the tank and the magnetostrictive probe.

2.3.2.2 Riser Pipe Maximum Length Requirements

1. Measure the distance from the grade level to the top of the tank.
2. Subtract 6 inches from the measurement in Step 1. This is the maximum riser length.

Note: The top of the riser should be no more than 18 inches below grade level.

Example for calculating the maximum length of the riser for an MTG probe:

If distance from the grade level to the top of the tank is 50 inches, you would perform the following calculation:

$$\begin{array}{r} 50 \text{ inches} \\ - 6 \text{ inches} \\ \hline 44 \text{ inches} \end{array}$$

Therefore 44 inches would be the maximum length of the riser for this example.

2.3.3 MTG Probe Installation

Hazardous work area. Block off work area to keep out vehicles. Observe all instructions, codes and regulations, and safety requirements.



Failure to comply can create an explosion hazard that can result in death, personal injury, and property damage.

When making electrical splices use the SK-4 connector sealing kit in accordance with the instructions. This provides a water-tight seal. You must use the proper cable and conduit configuration (see *Section 1.5 – Electrical Wiring*).



Failure to comply can result in water getting into the wiring and causing the system to fail.

1. Install the MTG probe into the tank through the riser.
2. Install the riser cap assembly.

Note: When installing the MTG probe, make certain that the shaft rests on the bottom of the tank and the top of the probe is in the riser. The top of the probe must not be permitted to fall into the tank. Also ensure that the probe is accessible and replaceable from grade level.

2.3.4 MTG Probe Field Wiring

This procedure provides the installation instructions and field wiring for the Magnetostrictive Tank Gauging (MTG) Probe shown in Figure 2-3 and *Appendix A – Probes*. This probe monitors the tank's water level, product level, and temperature. For petroleum applications and chemical applications, refer *Appendix A – Probes*. Consult OMNTEC for specific installation guidelines appropriate to the chemicals being stored.

The MTG Probe has three wires that are color coded as follows:

WHITE = Signal

BLACK = Signal Ground

GREEN = Shield (connect to the extension cable's drain wire).

Do the following:

1. Bring the probe's cable to the weatherproof junction box.
2. Make the wiring connections. Use the SK-4 connector sealing kit (provided) for all splices. Follow the instructions provided with the kit and refer to *Appendix C – Connector Sealing Kits*.

Note: You must use *Shielded cable #22 AWG (Belden #8761) or OMNTEC part # EC-2. For cable lengths greater than 1,000 feet contact OMNTEC Mfg., Inc. for further instructions.*

2.3.4.1 Probe Cable

Select probe cable with the following specifications:

- ◆ **Must** use Shielded cable #22 AWG (Belden #8761) or OMNTEC part # EC-2. For cable lengths greater than 1,000 feet contact OMNTEC for further instructions.
- ◆ Cable capacitance shall be less than 60 pf per foot.
- ◆ Cable inductance shall be less than 0.2 μ H per foot.

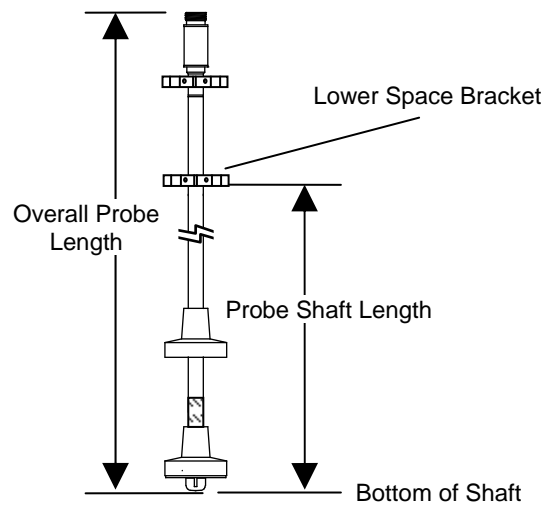

Fig. 2-3: Magnetostrictive Probe

2.3.4.2 MTG Probe Connections at the Controller

Make the probe connections at the controller as follows (refer to Figure 2-4):

1. Connect the Signal wire (white) to the positive (+) terminal.

2. Connect the Signal Ground wire (black) and Shield/Drain wire (bare) to the negative (-) terminal.
3. Record the probe numbers (T1-T8) you have selected. They are marked on the motherboard, (see *Appendix D – OEL8000II Controller*). You will need this information when you are programming the controller.

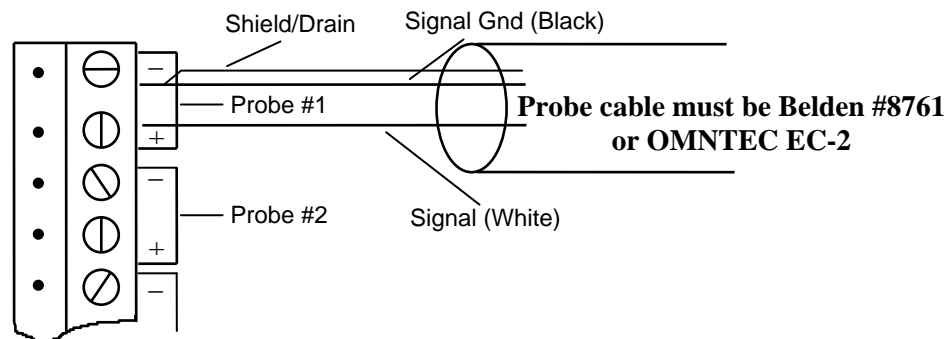

Fig. 2-4 Probe Connection

2.4 Sensors

The OEL8000II controller can monitor up to forty-four Bright Eye® (BX-series) product distinguishing or non-distinguishing leak and level detectors (KOEL8000II kits monitor up to eight BX-series sensors). A microprocessor is built into each BX sensor that gives it the ability to communicate with the OEL8000II controller. Each controller is equipped with two buss connectors. Each is capable of accepting up to 22 sensors. These sensors are rated for Class I, Group D, hazardous locations (for wiring and networking instructions see *Section 2.4.13 – Field Wiring*). Detectors are available with one or with combinations of the following sensing methods:

Note: Some sensors are shipped with a BX-UT sensor.

- ◆ **Optics** – Sensor contains a pulsing light source and a photo-sensor that detects reflected light. A normally closed circuit (un-alarmed condition) exists in a dry condition because light is reflected back to the sensor. The presence of a liquid, however, will result in light being refracted away from the photo-sensor creating an open circuit (alarm condition).
- ◆ **Conductance** – Sensor contains a conducting water electrode. In a dry environment or when the sensor is immersed in a non-polar liquid, there is no conductance and an open circuit (un-alarmed condition) exists. Water, however, conducts electricity. When the sensor is immersed in water, a circuit is completed and the sensor detects current flow (alarmed condition).
- ◆ **Optics and Conductance** – A single unit containing optics and conductance sensors. This single unit can be used to detect the presence of liquid and to

discriminate between water and hydrocarbons. An un-alarmed condition exists in a dry environment where light is reflected back to the photo-sensor. The presence of hydrocarbons will cause the optics sensor to initiate an alarm. The presence of water will cause the conductance sensor to initiate an alarm.

- ◆ **Float** – Sensor containing a device whose specific gravity is compatible with the liquid being monitored. It will float on the liquid and rise as the level increases. Floats can be configured to be normally closed (un-alarmed) in a dry environment and create an open circuit (alarmed) when liquid is present. They can also be configured to be normally open (un-alarmed) in liquid and initiate an alarm when the float drops creating a closed circuit.
- ◆ **Temperature** – Sensor containing a thermistor to measure temperature. Temperature sensors can be configured to alarm at high and low temperatures. They can also be programmed as relay activator sources. Two additional set points can also be used for temperature control (thermostat) relay activator source.
- ◆ **Vapor Sensor** – Sensor containing an adsistor to sense the presence of hydrocarbon vapor in a dry environment. The presence of hydrocarbon vapor causes the adsistor to increase in resistance creating a *vapor detected* alarm. Sensor can be configured as a relay activator source.

2.4.1 Sensor Cable

Select sensor cable with the following specifications:

- ◆ **Must** use #22 gauge shielded 4 conductor twisted with a drain, (Belden #9940 or equivalent). Do not exceed 2,000 feet. You can use part number EC-4 (4-wire plus drain)
- ◆ PVC jacketed UL-18830

2.4.2 BX-PDWF Sensor

The BX-PDWF (see Figure 2-5) detects liquids and is used in double-wall fiberglass tanks with dry interstitial space. It combines optical and conductance sensing enabling it to discriminate between water and hydrocarbons.

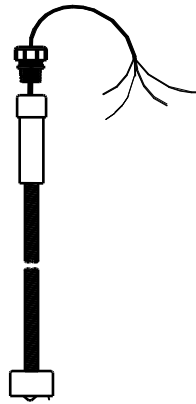

Fig. 2-5: BX-PDWF

2.4.2.1 Riser Pipe for BX-PDWF

1. Locate the interstitial bung on the side of the tank that is at the lower end of the pitch (tilt).
2. Install a riser into the bung.
3. The riser pipe must be:
 - ◆ 4 inch NPT
 - ◆ made of ANSI schedule 40 pipe
 - ◆ threaded on both sides

Minimum Length Requirements

For this application, the minimum length of the riser must be 18 inches so as to cover the handle.

Riser pipe maximum length requirements

1. Measure the distance from the grade level to the top of the tank.
2. Subtract 6 inches from the measurement in Step 1. This is the maximum riser length.

Note: The top of the riser should be no more than 18 inches below grade level.

For example: If distance from the grade level to the top of the tank is 50 inches, you would perform the following calculations:

$$\begin{array}{r} 50 \text{ inches} \\ - 6 \text{ inches} \\ \hline 44 \text{ inches} \end{array}$$

Therefore 44 inches would be the maximum length of the riser for this example.

2.4.2.2 BX-PDWF Installation

1. Snake the sensor into the tank's interstitial space (see Figure 2-6). As you push it, the sensor will move around the outside of the inner tank.
2. Keep pushing the sensor until the PVC handle contacts the inner tank. The sensor should now be at the bottom of the interstitial space.
3. Attach the riser cap (not supplied).
4. Install the 3/4 inch NPT oil tight cord grip provided with the sensor for strain relief.

Be sure to seal properly to prevent the possibility of water intrusion.

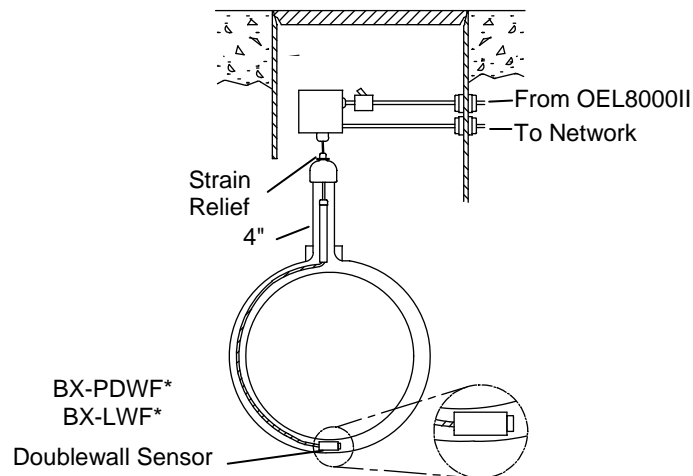

Fig. 2-6: BX-PDWF Installation

**Ensure that the sensor is the proper length for the tank prior to installation.
Ensure that the sensor is accessible and replaceable from grade level.**



Failure to comply will result in improper system operation.

2.4.3 BX-PDWS

The BX-PDWS sensor (see Figure 2-7) detects liquids in the interstitial space of a double-wall steel tank. It combines optical and conductance sensing enabling it to discriminate between water and hydrocarbons.

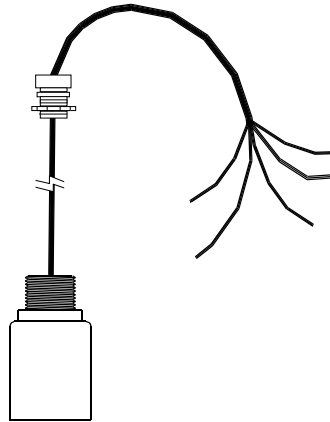

Fig. 2-7: BX-PDWS Sensor

2.4.3.1 Riser Pipe for BX-PDWS

1. Locate the tank's interstitial monitoring tube at the end of the tank.
2. Install a riser into the tube.
3. The riser pipe must be:
 - ◆ 2 inch NPT
 - ◆ made of ANSI schedule 40 pipe
 - ◆ threaded on both sides

Minimum Length Requirements

None

Riser pipe maximum length requirements

1. Measure the distance from the grade level to the top of the tank.
2. Subtract 6 inches from the measurement in Step 1. This is the maximum riser length.

Note: The top of the riser should be no more than 18 inches below grade level.

For example: If distance from the grade level to the top of the tank is 50 inches, you

would perform the following calculations:

$$\begin{array}{r} 50 \text{ inches} \\ - \underline{6 \text{ inches}} \\ 44 \text{ inches} \end{array}$$

Therefore 44 inches would be the maximum length of the riser for this example.

2.4.3.2 BX-PDWS Installation

1. Lower the sensor into the monitoring tube it until it reaches the bottom (see Figure 2-8).
2. Install a 2" by 3/4" NPT reducer bushing (not supplied)
3. Install the supplied 3/4" NPT oil tight cord grip.
4. Pull the sensor cable taut and then pull up the sensor approximately 1/4 inches.
5. Tighten the cable clamp to seal around cable and 2" by 3/4" bushing.

Be sure to seal properly to prevent the possibility of water intrusion.

Note: Ensure that the sensor is accessible and replaceable from grade level

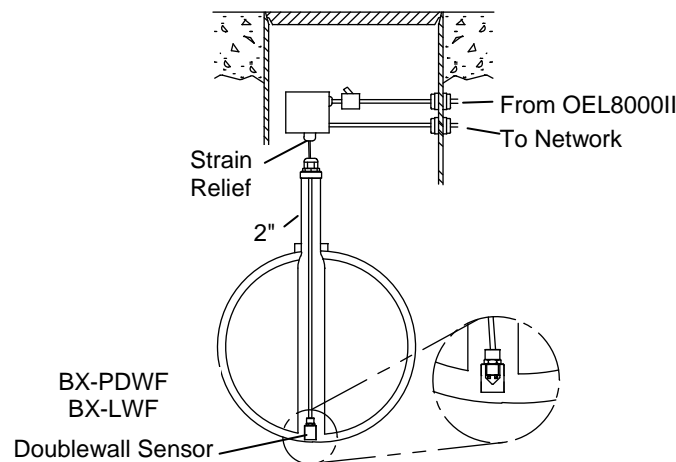

Fig. 2-8: BX-PDWS Installation

2.4.4 BX-PDS

The BX-PDS sensor (see Figure 2-9) is used for detecting leaks in manways, dikes, and sumps above or below ground. It combines optical and conductance sensing enabling it to discriminate between water and hydrocarbons.

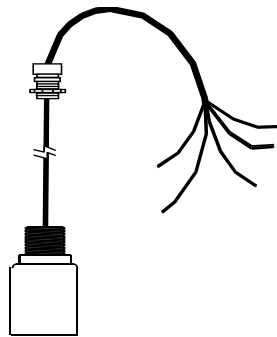

Fig. 2-9: BX-PDS

BX-PDS Installation

The sensor can be allowed to hang down when inserted into an in-line pipe or can be screwed into one end of a conduit (see Figure 2-10). Position the sensor close to the low point in the containment area. The other end of the conduit is screwed into a weatherproof junction box. It is recommended that conduit be used so as to avoid exposed wiring. The sensor is supplied with a 3/4 inch NPT nipple for conduit connections.

Install the 3/4-inch NPT oil tight cord grip provided with the sensor for strain relief.

Be sure to seal properly to prevent the possibility of water intrusion.

Note: Ensure that the sensor is accessible and replaceable from grade level.

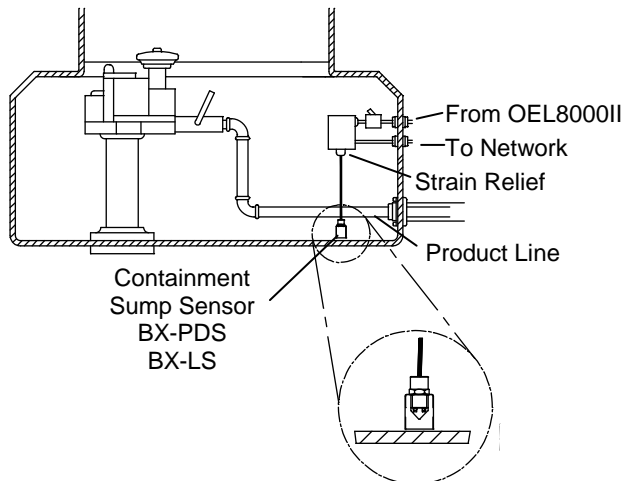

Fig. 2-10: BX-PDS Installation

2.4.5 BX-L12, BX-L20, BX-LV Series

The BX-L12, BX-L20, BX-LV (see Figure 2-11) is an optical sensor with a 2-inch NPT bushing that is an integral part of the sensor. It is inserted into an appropriate 2-inch opening on the top of the tank (see Figure 2-12). It is used for high level detection of the product. Access may be through a sump or it may be necessary to excavate from grade.

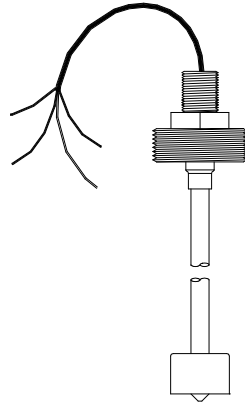

Fig. 2-11: BX-L*

2.4.5.1 Riser Pipe for BX-L12, BX-L20, BX-LV Series

If a riser pipe is used, determine its length by how far the sensor goes into the tank.

1. Determine the distance of the high point from the top of the tank.
2. Subtract the value found in Step 1 from the length of the sensor. This is the riser pipe length.

2.4.5.2 BX-L12, BX-L20, BX-LV Installation

Screw the BX-L12, BX-L20, BX-LV sensor directly into the bung hole or riser via the 2 inch NPT bushing. Use a reducing bushing if necessary.

Note: Ensure that the sensor is accessible and replaceable from grade level.

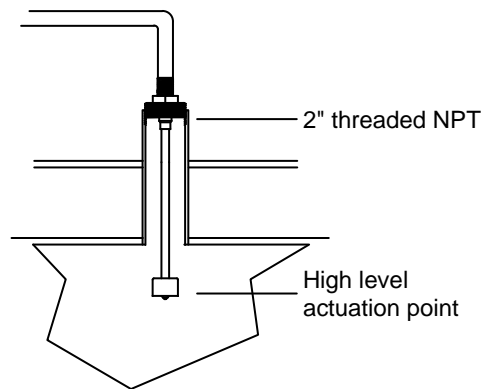

Fig. 2-12: BX-L12, BX-L20, BX-LV

2.4.6 BX-LM* Series

The BX-LM* (see Figure 2-13) contains two optical sensors for multi level detection and a 2-inch NPT bushing that is an integral part of the sensor. It is inserted into an appropriate 2-inch opening on the top of the tank. It is used for high level and low level detection of the product or it can be used for caution and high level detection. Access may be through a sump or it may be necessary to excavate from grade.

2.4.6.1 Riser Pipe for BX-LM* Series

If a riser pipe is used and the sensor is used for high level detection, perform the following calculation:

1. Determine the distance of the high point from the top of the tank.
2. Measure the distance from the top of the BX-LM* to the upper sensor.
3. Subtract the value found in Step 1 from the measurement in Step 2. This is the required length of the riser.

2.4.6.2 BX-LM* Installation

Screw the BX-LM* directly into the bung hole or riser via the 2-inch NPT bushing. Use a reducing bushing if necessary. If the BX-LM* is also being used for low level detection, make certain that it is of sufficient length such that the bottom of the sensor is at least six (6) inches above the bottom of the tank. This is to allow for tank deflection.

Note: Ensure that the sensor is accessible and replaceable from grade level.

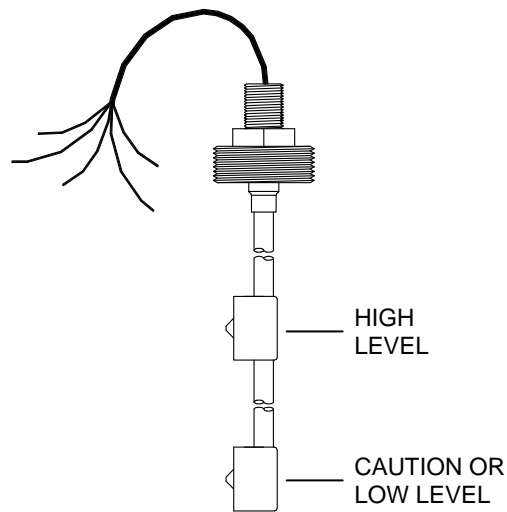

Fig. 2-13: BX-LM*

2.4.7 BX-RES

The BX-RES (see in Figure 2-14) is an optical reservoir sensor used in the tank's interstitial space containing a brine solution. A rise in the level of the reservoir liquid is indicative of outside water getting in due to a breach in high ground water conditions, or product due to an inner wall breach in high ground water conditions. A drop in the liquid level can be caused by a breach in the inner or outer wall.

When installing sensor, ensure that the brine level is within proper proportion to the amount of product in the tank. Obtain a brine chart from your tank manufacturer for purposes of this installation.

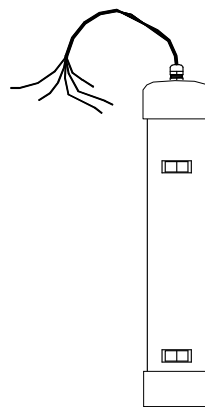

Fig. 2-14: BX-RES

2.4.7.1 Riser Pipe for BX-RES

1. Locate the reservoir bung.
2. Install a riser into the bung.
3. The riser pipe must be:
 - ◆ 4 inch NPT
 - ◆ made of ANSI schedule 40 pipe
 - ◆ threaded on both sides

Minimum Length Requirements

1. Measure the length of the sensor from tip to tip.
2. Measure the depth of the reservoir.
3. Subtract the reservoir depth in Step 2 from the sensor length in Step 1.
4. Add four (4) inches to the calculation in Step 3. This is the minimum riser length.

Maximum Length Requirements

1. Measure the distance from the grade level to the top of the reservoir.
2. Subtract six (6) inches from the measurement in Step 1. This is the maximum riser length.

2.4.7.2 BX-RES Installation

1. Lower the sensor into the reservoir until it hits the bottom.
2. Install reducer bushing
3. Install the 3/4 inch NPT oil tight cord grip provided with the sensor for strain relief.

Be sure to seal properly to prevent the possibility of water intrusion.

Note: Ensure that the sensor is accessible and replaceable from grade level

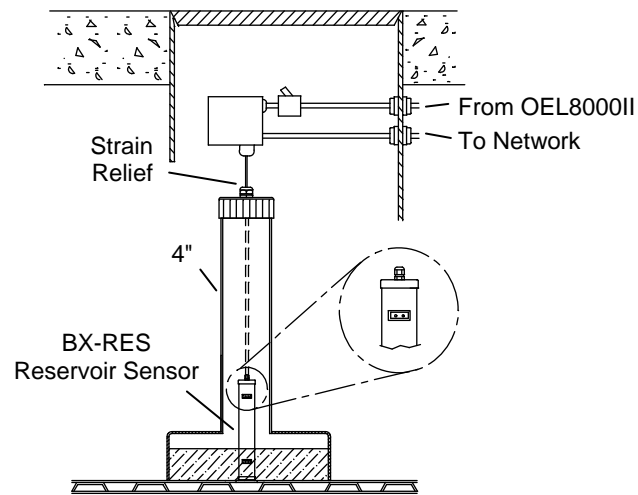

Fig. 2-15: BX-RES Optical Reservoir Sensor

2.4.8 BX-LS

The BX-LS sensor (see Figure 2-16) is used for detecting leaks in manways, dikes, and sumps *above or below* ground. It uses optical technology to detect liquid presence. The sensor generates an alarm when it detects liquid.

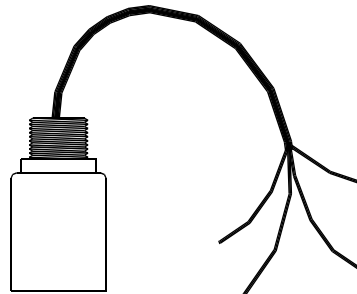

Fig.: 2-16: BX-LS

BX-LS Installation

The sensor can be allowed to hang down when inserted into an in-line pipe or can be screwed into one end of a conduit (see Figure 2-10). Position the sensor close to the low point in the containment area. The other end of the conduit is screwed into a weatherproof junction box. It is recommended that conduit be used so as to avoid exposed wiring. The sensor is supplied with a 3/4-inch NPT nipple for conduit connections.

Install the 3/4-inch NPT oil tight cord grip provided with the sensor for strain relief.

Be sure to seal properly to prevent the possibility of water intrusion.

Note: Ensure that the sensor is accessible and replaceable from grade level

2.4.9 BX-LSR

The BX-LSR sensor is similar to BX-LS sensor, however, it operates in reverse. It's in its normal state when it detects liquid. The installation procedure is the same.

2.4.10 BX-LWF

The BX-LWF (see Figure 2-17) detects liquids and is used in double-wall fiberglass tanks with dry interstitial space. It uses optical technology to detect leaks in interstitial spaces.

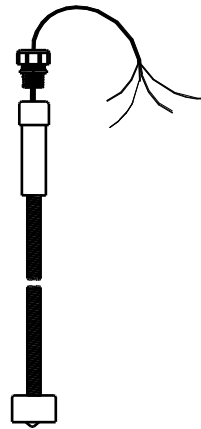

Fig. 2-17: BX-LWF

2.4.10.1 Riser Pipe for BX-LWF

Locate the interstitial bung on the side of the tank that is at the lower end of the pitch (tilt). Install a riser into the bung. The riser pipe must be:

- ◆ 4 inch NPT
- ◆ made of ANSI schedule 40 pipe
- ◆ threaded on both sides

Minimum Length Requirements

For this application, the minimum length of the riser must be 18 inches so as to cover the handle.

Maximum Length Requirements

1. Measure the distance from the grade level to the top of the tank.
2. Subtract 6 inches from the measurement in Step 1. This is the maximum riser length.

Note: The top of the riser should be no more than 18 inches below grade level.

For example: If distance from the grade level to the top of the tank is 50 inches, you would perform the following calculations:

$$\begin{array}{r} 50 \text{ inches} \\ - 6 \text{ inches} \\ \hline 44 \text{ inches} \end{array}$$

Therefore 44 inches would be the maximum length of the riser for this example.

2.4.10.2 BX-LWF Installation

1. Snake the sensor into the tank's interstitial space (see Figure 2-6). As you push it, the sensor will move around the outside of the inner tank.
2. Keep pushing the sensor until the PVC handle contacts the inner tank. The sensor should now be at the bottom of the interstitial space.
3. Attach the riser cap (not supplied).
4. Install the 3/4-inch NPT oil tight cord grip provided with the sensor for strain relief.

Be sure to seal properly to prevent the possibility of water intrusion.

Ensure that the sensor is the proper length for the tank prior to installation.

Ensure that the sensor is accessible and replaceable from grade level.



Failure to comply will result in improper system operation.

2.4.11 BX-TC

The BX-TC-1 (see Figure 2-18) was designed to monitor temperatures ranging from -50° to 150°C with an accuracy of ± 1°C. High and low temperature alarm points are user programmable. Temperature ranges for alarm conditions are set in the OEL8000II's programming (see *Section 4.3.10.1.4 – Temperature (BXTC) Sensor*

Activation).

Note: If using High and Low alarm points as a control (i.e., thermostat) an IB-RB2 Interface board must be installed (see Section 4.3.10.1 – Programming the IB-RB2 Relay Board).

Note: The BX-TC Sensor can be configured with a “dwell time” to avoid premature alarms.

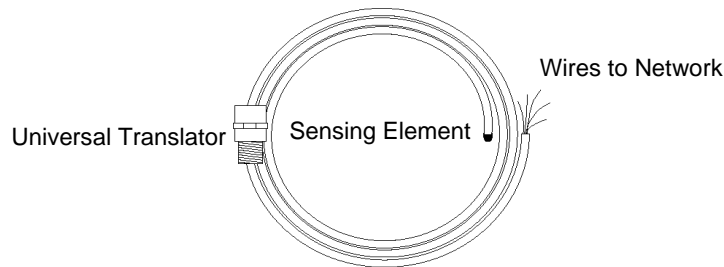

Fig. 2-18: BX-TC

BX-TC Calibration

1. Power OFF
2. Insert IB-RB2 board (optional)
3. Power ON
4. Select SETUP on the front panel.
5. Enter security code (default code is 000000)
6. Select SENSOR
7. Select CONFIG
8. LCD will display number of sensors found. Select OK
9. Select ENTER to scroll through sensors until the BX-TC sensor is selected
10. First time calibration set the location labels “refrig”, “freezer”, or other (user defined) or select EDIT to change or add settings.
11. Screen options:
 - ◆ ENTER – to accept changes
 - ◆ ERASE ALL – to erase present settings for this sensor
 - ◆ SELECT – to scroll from one setting to another
 - ◆ DEFAULT – to set settings to default settings (LO = 33, HI = 45, ON = 38, OFF = 41)

Enter in the location number or press select to move the cursor to the next selection. Enter in a value for “LO” (low alarm setting), “HI” (high alarm setting), “ON” (relay trip temperature) and “OFF” (relay trip temperature). The “ON” and “OFF” points only are used with and IB-RB-2 relay board. When the temperature goes above the “ON” point the relay will turn on. The relay will not turn off until the temperature goes below the “OFF” point.

12. Select ENTER to accept settings, then select EXIT twice to return to Screen #1 of the SETUP Submenu.

2.4.12 BX-VS

The BX-VS vapor sensor is capable of detecting gasoline at concentrations between 10 PPM and 100 PPM through surface absorption of volatile organics (i.e., gasoline, diesel and motor fuels). For specifications and installation of VS-1 vapor sensor consult factory.

2.4.13 FIELD WIRING

Bright Eye sensors are designed with four-wire technology, which allows the installer to network up to 22 sensors per buss. Each sensor has one bare wire and four color coded wires as follows:

RED	=	Power
GREEN	=	Communication A
WHITE	=	Communication B
BLACK	=	GND
BARE WIRE	=	Shield Drain

To connect the sensor to the network do the following (see Figure 2-19):

1. Be sure the BX-sensor worksheet is completed (see *Appendix B – Sensors*).
2. Connect the sensor wires to the network wires using wire nuts supplied in the SK-4 kit
3. Be sure to match wire colors.
4. Use the **SK-3** or **SK-4** connector sealing kit (provided) for all splices. Follow the instructions provided with the kit and refer to *Appendix C – Connector Sealing Kits*.

Note: If the cable you are using has a different set of color coded wires than the sensor, record the corresponding colors. You will need this information when making

the connections at the controller. **Must use Belden #9940 cable or equivalent, see Section 2.4.1 – Sensor Cable.**

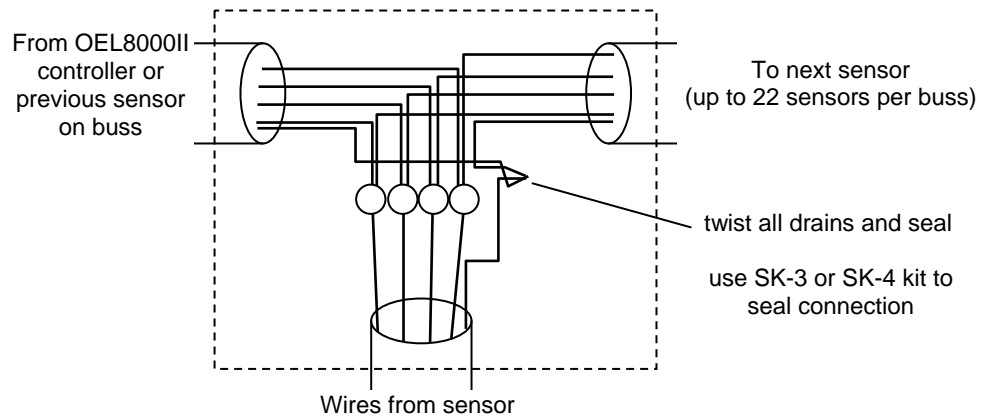

Fig. 2-19: Sensor Field Wiring

2.5 Annunciators (RAS Series)

Annunciators are audio/visual remote alarm systems that can be mounted outdoors and in remote locations to ensure faster response to alarms. They should be within hearing range and eye sight of the filling operator. **Annunciators must be installed in a non-hazardous location.** Models RAS-1, RAS-2, RAS-3, and RAS-4 (see Figure 2-20) can monitor one, two, three, and four tanks respectively. Combinations of the above models can be used to monitor up to eight tanks. Each model has a 95 dB horn and a corresponding LED for each tank being monitored. A reset button on each annunciator is used for deactivating the horn during a high level alarm. Refer to *Appendix E – Remote Annunciator*.

The annunciator will indicate the following condition:

- ◆ High level warning – flashing LED
- ◆ High-High level alarm – steady LED plus horn

If the horn silence button is depressed during a high level alarm, the horn will stop sounding. The LED, however, will remain illuminated until the alarm condition is eliminated. If the remote horn time is enabled, the horn will re-sound after a programmed period of time until the alarm condition is eliminated.

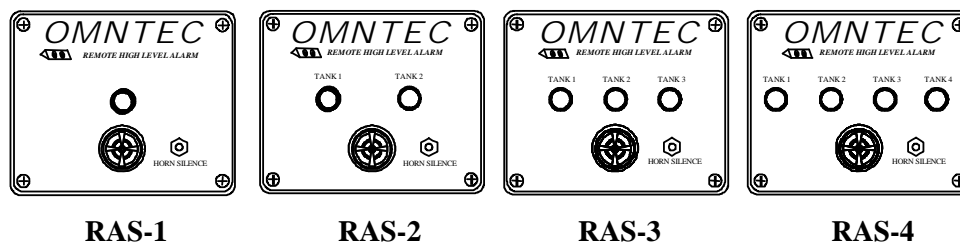

Fig. 2-20: Annunciators

Note: There is a fifth type of Annunciator model available for the OEL8000II. The RAS-1-NYS is similar to the RAS-1 except it has a large strobe light (60,000 candle power) and a louder horn (110 dB multi-frequency). Wiring for this model is the same as the RAS-1.

2.5.1 Mounting the Annunciator

Use the following procedure when installing annunciators:

1. Open the annunciator and use the holes in the four corners of the case as a template for mounting (the same holes are used for securing the front cover).
2. Use proper anchor bolts for wall type.
3. Be sure case is upright and key marks are aligned before mounting.

Do NOT install annunciator in a hazardous location.



Failure to comply will result in system damage.

2.5.2 Wiring for Annunciators

Conduit enters the annunciator through a drilled hole that should be made in the bottom panel of the annunciator housing. Do the following:

1. Bring the annunciator cable into the annunciator via the conduit.
2. Make the wiring connections.

Ensure that the conduit connection is watertight.

Note: You must use the proper cable (see Section 2.5.4 – Annunciator Connections at the controller). If the cable you are using has a different set of color coded wires than the annunciator, record the corresponding colors. You will need this

information when making the connections at the controller.

2.5.3 Wiring Configuration for Annunciators

Each LED corresponds to a specific tank number (1-8). If multiple annunciators are used, then adjust the tank numbers to reflect LED/Tank relationship. For example if two RAS-1 annunciators are being used, the LED wire (white) from one annunciator is designated to tank #1 and the other LED wire (white) from the second annunciator is designated to tank #2. Keep a record indicating the connectivity between LEDs and tank numbers.

The following describes the color coding for each annunciator model (see *Appendix E – Remote Annunciator*).

RAS-1 and RAS-1-NYS (one tank)—five wire

- RED = Power
- BLUE = Horn Silence (Acknowledge) Switch
- GREEN = Horn Alarm
- BLACK = GND
- WHITE = LED for tank #1

RAS-2 (two tanks)—six wire

- RED = Power
- BLUE = Horn Silence (Acknowledge) Switch
- GREEN = Horn Alarm
- BLACK = GND
- WHITE = LED for tank #1
- BROWN = LED for tank #2

RAS-3 (three tanks)—seven wire

- RED = Power
- BLUE = Horn Silence (Acknowledge) Switch
- GREEN = Horn Alarm
- BLACK = GND

WHITE = LED for tank #1

BROWN = LED for tank #2

ORANGE = LED for tank #3

RAS-4 (four tanks)—eight wire

RED = Power

BLUE = Horn Silence (Acknowledge) Switch

GREEN = Horn Alarm

BLACK = GND

WHITE = LED for tank #1

BROWN = LED for tank #2

ORANGE = LED for tank #3

YELLOW = LED for tank #4

2.5.4 Annunciator Connections at the Controller

The optional annunciators (RAS series) require #22 AWG low voltage communication wire as a minimum. You can use part number EC-12 (12 conductor) for RAS-1 (5 conductor), RAS-2 (6 conductor), RAS-3 (7 conductor), and RAS-4 (8 conductor).

Depending on the annunciator model, there will be from one to four additional wires. They are the LED wires. These wires are connected to the numbered terminals adjacent to the remote annunciator interface board.

The annunciator wires are brought to the controller's remote annunciator interface board, (see *Appendix E – Remote Annunciator*). Markings identify the terminals for:

12 VDC	(Red wire)
Ground	(Black wire)
Horn Silence (Acknowledge) Switch	(Blue Wire)
Horn Alarm	(Green Wire)

For RAS-1:

- ◆ White wire goes to “tank #1” terminal on remote annunciator interface board.

For RAS-2:

- ◆ White wire goes to “tank #1” terminal on remote annunciator interface board.
- ◆ Brown wire goes to “tank #2” terminal on remote annunciator interface board.

For RAS-3:

- ◆ White wire goes to “tank #1” terminal on remote annunciator interface board.
- ◆ Brown wire goes to “tank #2” terminal on remote annunciator interface board.
- ◆ Orange wire goes to “tank #3” terminal on remote annunciator interface board.

For RAS-4:

- ◆ White wire goes to “tank #1” terminal on remote annunciator interface board.
- ◆ Brown wire goes to “tank #2” terminal on remote annunciator interface board.
- ◆ Orange wire goes to “tank #3” terminal on remote annunciator interface board.
- ◆ Yellow wire goes to “tank #4” terminal on remote annunciator interface board.

Note: The above wire descriptions are based on the color coding used by the annunciators. If you are using a cable with a different color code, refer to the notes you made when you spliced the annunciator wires to the cable wires.

Multiple Annunciators: *If you are using more than one annunciator, all wires except the LEDs are combined and connected to the corresponding terminal at the remote annunciator interface board. For example: If 3 annunciators are used, all the horn alarm wires (green) are connected to the same terminal at the remote annunciator interface board, specifically the one labeled “+ Horn”. In other words terminals 1-4 are common for all annunciators. The LED wires are alarm specific and must only be connected to the alarm# it represents. (see Appendix E – Remote Annunciators).*

2.6 Interface Boards (IB-Series)

Up to 24 alarm relays (4 relays per card) can be added to the controller. They are individually programmed and can be used to automatically shut down external equipment such as dispenser pumps when a leak is detected (see *Section 4.3.10 – Int Brd* and *Appendix F – Interface Boards* for installation).

- ◆ IB-RAS
- ◆ IB-C420
- ◆ IB-12V
- ◆ IB-RB2
- ◆ IB-NET

Interface Board Wire

Select wire in accordance with code for this installation. Consult code if this wire is going to share the same conduit with other wires. There may be specific requirements pertaining to voltage levels and wire specifications.

2.7 Remote Communications

Access to the system by computer is achieved by adding either an internal 14,400 baud fax/modem or relay, or by utilizing the system's RS232 outputs. This allows for real time monitoring of the system and downloading of status information to any remote location, (See *Section 2.2.6 – Telephone Connections at the Controller*). A user friendly software program (OMNTEC PC) or serial communication sheets are available; call OMNTEC[®] Mfg., Inc. for further information.

Section 3 Applying Power

3.1 Preparations

The final steps in this installation consists of applying AC power to the controller followed by programming the controller. **Before you apply AC power, do the following:** (1) review the **Checklist** below and (2) fill out the **System Start-up List** on the next page to confirm that all installation steps have been completed.

Do not make any wiring connections at the tanks, junction boxes, controller, or any other location when power is applied to the controller.



Failure to comply can create an electric shock or explosion hazard causing death, personal injury, or property damage.

3.2 Checklist

Before you apply power to the controller, re-inspect the installation using the following checklist as a guide:

- All probe and sensor installations have been completed.
- All conduit, junction boxes, and Eys installations have been completed (inside and outside the building).
- All cable and wiring connections have been completed.
- All wiring connections in the controller have been completed (including earth ground and field ground).
- Controller is field grounded to the main electrical service power, **not** a sub-panel.
- All installations have been re-inspected.
- All installations comply with the instructions in this manual, National Electrical Code, and the federal, state, and local codes and regulations.
- Close the metal cover inside the controller.
- Close the controller door.

3.3 System Start-up Checklist

SYSTEM START-UP LIST Date: _____ **OEL8000II Serial #** _____

✓	INSTALLATION AND INTRINSIC SAFETY CHECKLIST
	SENSORS AND MTG-PROBES
	Piping sump – sensor is installed in lower part of sump
	Interstitial – sensor is located at low point of interstitial space
	Dispenser pan – sensor is located at low point in dispenser
	Reservoir sensor – bottom of sensor touching bottom of reservoir. Brine level should be between sensor prisms
	Strain reliefs are properly sealed
	Doublewall tank Interstitial monitors must have either a 4" riser to grade for fiberglass or a 2" riser to grade for stainless steel
	Sensor wiring is 22 gauge 4 conductor twisted shielded with a drain, (OMNTEC EC-4 cable)
	Sensor shield drain wire is connected to ground terminal at sensor connector in the controller
	OEL8000II sensor wiring runs not to exceed 2000ft from the controller to the furthest sensor
	MTG-probe wiring is 22 gauge OMNTEC EC-2 or Belden#8761 cable – use of equivalent will VOID warranty
	MTG shield drain wire is connected to the ground terminal at the MTG connector in the controller
	OEL8000II MTG-probe wiring runs do not exceed 1000ft
	All outdoor wiring connections are sealed with SK-3 or SK-4 epoxy sealing kits
	Seal-offs are installed between building and tanks on probe and sensor conduits
	MTG-probe and sensor wiring connections in tank area are installed in suitable weatherproof junction boxes
	MTG-probe and sensor wires are combined in a separate isolated conduit (must be kept in isolation from all other wires)

	OEL8000II MONITOR and MTG-PROBES
	OEL8000II monitor is installed indoors in an accessible location
	Conduits enter OEL8000II only through preformed knock-outs
	Power wires are installed in a separate isolated conduit
	Annunciator (RAS series) wires are installed in a separate isolated conduit
	OEL8000II monitor has an earth ground connected with 12 gauge wire
	Press test button
	Check print out for proper system response
	Test RAS-series remotes (if applicable) – press test button again. In approx. 60 sec. the RAS-horn & light(s) will go on.

	OEL8000II TRAINING GUIDELINES
	End user or facility manager should know:
	Complete and return Warranty Card to OMNTEC
	To review Owner's Manual
	Location of the console, printer, and remote annunciator

	The function of each push button on the key pad
	Location and purpose of probes and sensors
	What potential alarms could occur for this configuration
	How to adjust for day light savings
	How to change the paper
	How to print and acknowledge alarm(s)
	How to print out inventory reports
	How to start and stop an in-tank leak detection test (if applicable)
	How to enable auto alarm printout
	Only qualified and authorized personnel can install or service any component of the OEL8000II system

Start-up Installer

Name: _____

Address: _____

Signature: _____

Tel: ____ - ____ - ____ Ext: ____

Construction site: _____

Tel: ____ - ____ - ____ Ext: ____

Dealer/Manager/Owner

Name: _____

Site Address: _____

Signature: _____

Tel: ____ - ____ - ____ Ext: ____

Signature: _____

Tel: ____ - ____ - ____ Ext: ____

3.4 Connecting Power

When you have confirmed that the entire installation is complete, you may apply power to the controller by closing the circuit breaker.

Upon powering up, the controller will indicate if any problems were detected. The following identifies those problems and the corrective action to be taken:

Remove all power to the controller when performing repairs.



Failure to comply can create an electric shock or explosion hazard causing death, personal injury, or property damage.

- ◆ **Fault LED (red light) is on** – indicates a problem with the RAM, PROM, or other internal circuitry. Contact manufacturer.
- ◆ **LCD displays Probe Error** – It may indicate a poor probe connection. This message will appear only after the system has been powered up and programmed. Remove power, correct problem and reapply power. Refer to *Section 5.7 – Troubleshooting Probe Guide*.

Section 4 Programming

4.1 Preparation

Most systems are factory programmed. If your system is pre-programmed verify that all settings are accurate to your site needs.

This section describes the programming of the controller. It is the final step in the installation process and it is performed after all of the hardware has been installed and all of the electrical connections have been made. To complete this procedure, you will need tank data, probe and sensor data, and additional data to be obtained from the customer. Before you begin programming, it is recommended that you review this section and obtain all of the required information. You may use this part of the manual as a worksheet by recording all of the data in the appropriate sections.

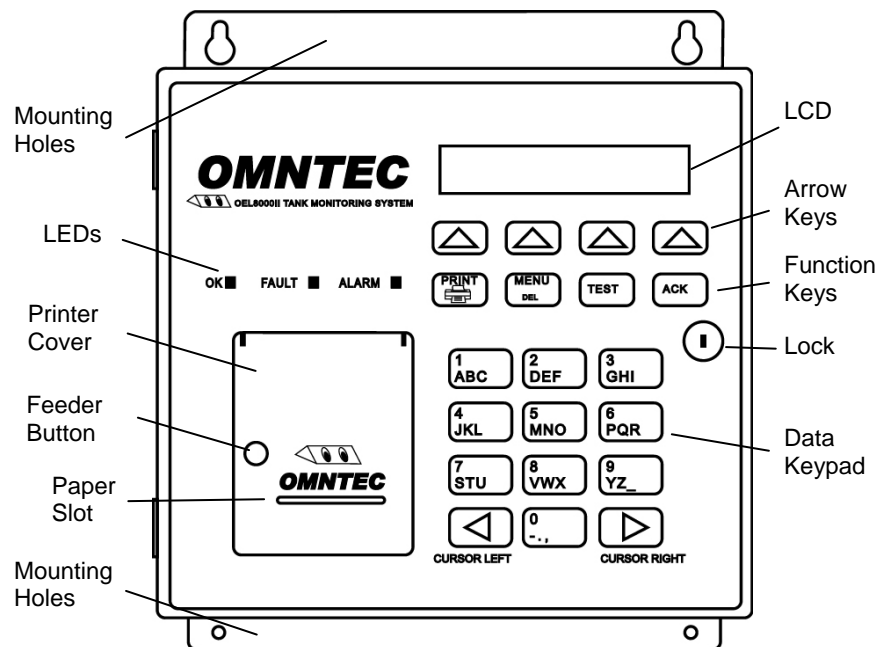

Fig. 4-1: OEL8000II Controller's Front Panel

4.2 Procedure

In order to program the controller you must become familiar the LCD display, the tactile keypad, and the printer (see Figure 4-1). The tactile keypad consists of the arrow keys, the function keys (directly below the arrow keys), and the data keypad.

4.2.1 LCD Display

The LCD provides a four line display with a maximum of forty characters per line. Figure 4-2 provides a sample display. During programming, the following will appear on the screen:

- ◆ First line: displays the day, date, time, and status.
- ◆ Second line: prompts you for specific data.
- ◆ Third line: displays the data you are entering.
- ◆ Fourth line: displays up to four fields for navigating screens and selecting functions.

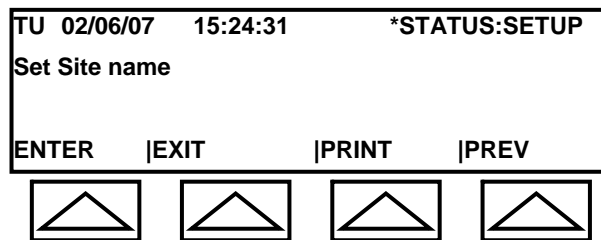

Fig. 4-2: Sample Screen

4.2.2 Tactile Keypad

This section describes the use of the tactile keypad during programming. Refer to the *OEL8000II Owner's Manual* for additional information on the controller's front panel displays and controls.

- ◆ **Arrow Keys** – Four upward pointing arrows point to the fields shown on the last line of the LCD display. Select the appropriate field by pressing the arrow that points to it.
- ◆ **Data Keypad** – The keypad resembles a telephone keypad and is used for entering data. You enter the number, letters, or characters shown on a key by repeatedly pressing that key. To enter the number **1**, for example, press the key with the number **1** on it just one time. To enter the letter **A**, press that same key two times. For the letter **B**, press it three times, and for the letter **C**, press it four times.
- ◆ **Cursor Keys** – The right cursor key moves the cursor to the right. The left cursor key moves the cursor to the left.

Note: The cursor will automatically advance when entering data. To use the same key consecutively, use the right cursor key to advance or wait for 2 seconds and the cursor will advance automatically. You can insert a blank by pressing the cursor key or by pressing the 9 key four times. This inserts a blank character and advances the cursor to the next position.

- ◆ **DEL Key** – The delete key has the word **DELETE** below the word **MENU**. If the cursor is under a character, pressing the **DELETE** key will cause that character to be deleted. If the cursor is under a blank space, it will move to the left and delete the character in that position.

*Note: To change a character several positions back, use the left cursor key to get to that position and make the correction. By not using the **DELETE** key, you avoid deleting everything in-between.*

4.2.3 Printer

To obtain a hardcopy printout, you can press the PRINT function key or the arrow beneath the PRINT field whenever it appears on the bottom line of the LCD.

4.3 Programming Procedures

The procedures discussed in the following sections provide instructions for programming the controller. If your controller has been factory programmed, you can use the same procedures for verifying or making modifications.

Note: Do not change programming for Volume Leak Test Time (4 hours) and Dwell Time (30 minutes).

All programming begins at the MAIN Menu, which has a total of six screens (see Figures 4-3a through 4-3f). To advance from one screen to the next, select MORE on the bottom line of the LCD (press the arrow key directly beneath it). Selecting MORE in Screen #6 will return the LCD to Screen #1.

While in the Main Menu, the Status field should display NORMAL. If an alarm condition exists, it will display ALARM.

Note: Throughout the remainder of this manual, when directed to select a field on the bottom line of the LCD, press the arrow key directly beneath the field.

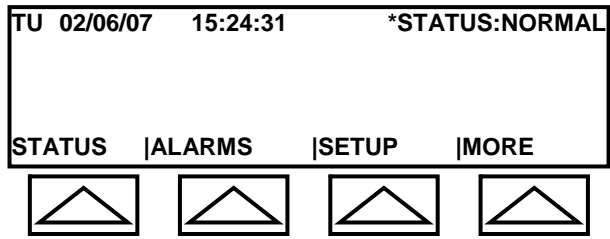

Fig. 4-3a: Main Menu – Screen #1

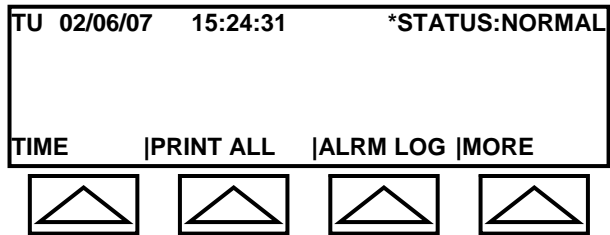

Fig. 4-3b: Main Menu – Screen #2

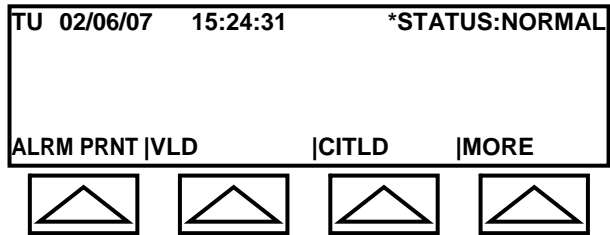

Fig. 4-3c: Main Menu – Screen #3

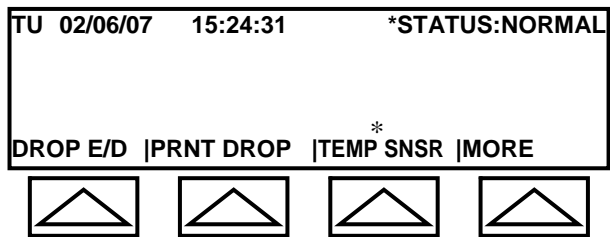

Fig. 4-3d: Main Menu – Screen #4

*TEMP SNSR only shows when a BX-TC is installed in unit.

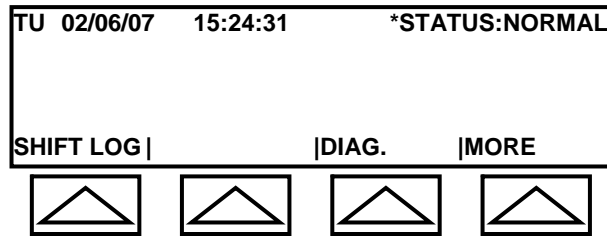

Fig. 4-3e: Main Menu – Screen #5

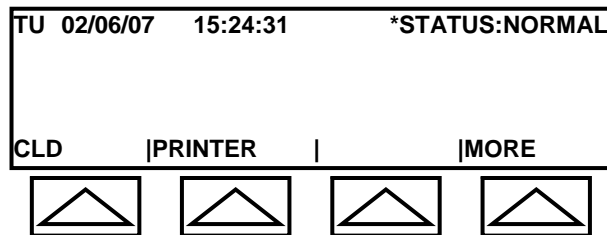

Fig. 4-3f: Main Menu – Screen #6

4.3.1 Entering the SETUP Mode

Starting in Screen #1 of the Main Menu, select SETUP.

System Response

The screen will appear as in Figure 4-4.

The first line of the screen remains unchanged.

The second line reads: **Enter In The Security Code.**

The third line contains a cursor and will display a series of X's to disguise the security code as you enter it.

The fourth line has ENTER and EXIT fields. The ENTER field will be selected after entering all of the data on the third line. If the EXIT field is selected, the LCD display will return to Screen #1 of the Main Menu (see Figure 4-3a) without entering the data.

4.3.2 Entering the Security Code

You must enter the security code to continue. When programming the controller for the first time, use the default value (6 zeroes): **000000**.

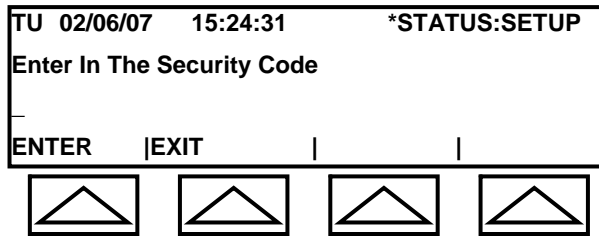

Fig. 4-4: Security Code

1. Enter "000000".

System Response

The character **X** will appear in each of the first six columns on the third line. The actual security code that is entered is not displayed.

2. Press the arrow beneath ENTER.

System Response

If the wrong security code is entered, the system will return to Screen #1 of the Main Menu (see Figure 4-3). If the correct security code is entered, the system will proceed to the Screen #1 of the SETUP Menu (see Figure 4-5a).

The SETUP Menu has five screens (see Figure 4-5a through Figure 4-5e). Select MORE on the bottom line of the LCD to advance through the screens. Selecting MORE in Screen #5 returns the LCD to Screen #1.

To exit the SETUP Menu, press the **MENU** key (below the arrow keys). The LCD will return to the MAIN Menu.

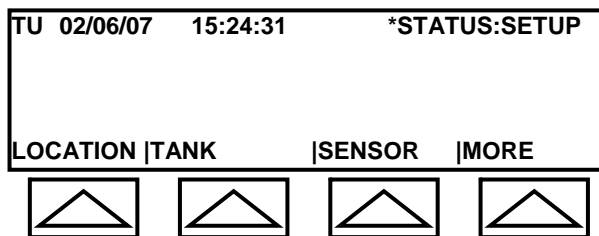

Fig. 4-5a: Setup Menu – Screen #1

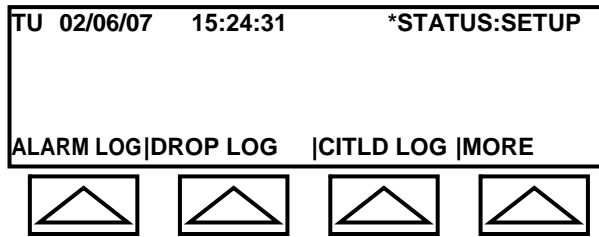

Fig. 4-5b: Setup Menu – Screen #2

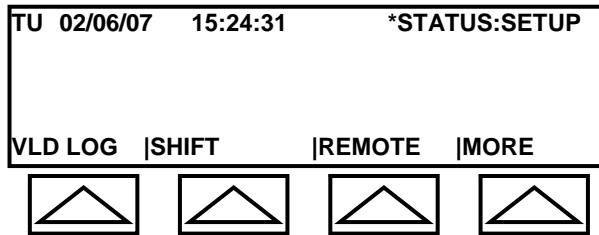

Fig. 4-5c: Setup Menu – Screen #3

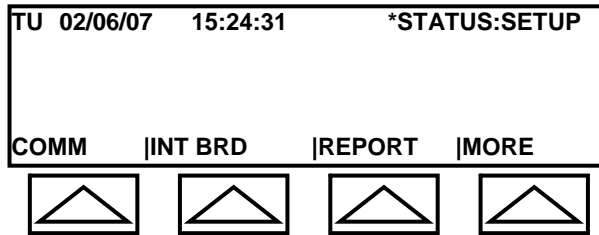

Fig. 4-5d: Setup Menu – Screen #4

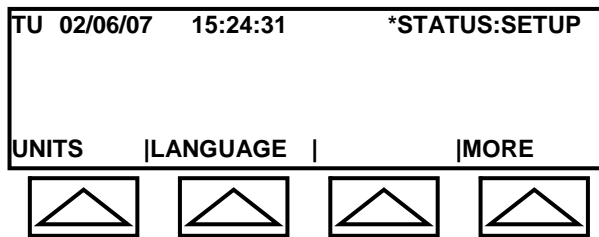

Fig. 4-5e: Setup Menu – Screen #5

4.3.3 Location Data

The Location Submenu allows you to enter site-specific data.

Starting in Screen #1 of the SETUP Submenu, select LOCATION.

*Note: To return to the MAIN Menu from the Location Submenu, select EXIT and then press the **MENU** key. The LCD returns to Screen #1 of the MAIN Menu (see Figure 4-3a).*

System Response

The screen will appear as in Figure 4-6.

Line 1 remains unchanged.

Line 2 reads: **Enter site name.**

Line 3 shows a cursor.

Line 4 has a new set of fields.

Field Descriptions

- ◆ ENTER – select this field to save entered data and to advance to the next screen.
- ◆ EXIT – returns to Screen #1 of the SETUP Submenu.
- ◆ PRINT – provides a hardcopy printout of all Location Data.
- ◆ PREV – returns to previous screen.

4.3.3.1 Site Name

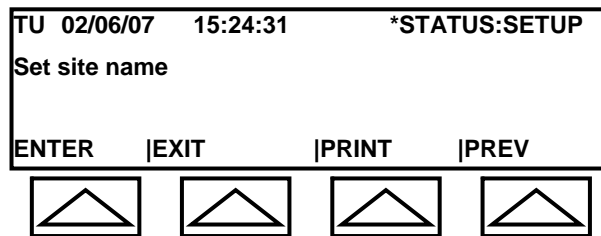

Fig. 4-6: Location Submenu

1. Enter the site name.

System Response

The site name appears on line 3.

2. Select ENTER.

System Response

Lines 1 and 4 of Figure 4-6 remain unchanged.

Line 2 reads: **Set security code, 6 Numeric Digits.**

Line 3 displays the default code **000000** or the current security code, if one has already been programmed into the system.

4.3.3.2 New Security Code

A security code consists of number only. To enter new code, begin with Step 1. If you wish to keep the existing security code, skip to Step 3.

Note: If you are entering a new security code, make sure you write it down. You will no longer be able to use the old or the default security code.

1. Press the **DEL** key 6 times to erase the old number.

System Response

Line 3 will become blank and show a cursor.

2. Enter 6 numbers.

System Response

The numbers will appear on line 3.

3. Select ENTER.

System Response

Lines 1 and 4 of Figure 4-6 remain unchanged.

Line 2 reads: **Set the vol. leak test time, (hours).**

Line 3 displays a cursor.

4.3.3.3 Preprogrammed Data

The volume leak test time and the following four screens have been preprogrammed at the factory.

1. Select ENTER to advance through the screens. Lines 2 and 3 will show the changing prompt and its value (see below). Lines 1 and 4 will remain unchanged.

If you choose to change values, use the data keypad then select ENTER (see comments below before changing values).

Line 2: Prompt	Line 3: Programmed Value
Set the vol. leak test time, (hours)	4 (Contact mfg. before you change this value.)
Set the vol. dwell test time, (mins)	30 (Contact mfg. before you change this value.)
Set the vol. leak test level, (.1, .2)	.1 yearly or .2 monthly
Set the drop report threshold, (G)	100 (Contact mfg. before you change this value.)
Set the drop report dwell time, (mins)	5 (Contact mfg. before you change this value.)

2. While in the **Set the drop report dwell time** screen, select ENTER.

Note: The system permits you to enter two lines for site address. Only the street address is entered into site address line 1 and site address line 2. There are separate screens for city, state, and zip code.

System Response

Lines 1 and 4 of Figure 4-6 remain unchanged.

Line 2 reads: **Enter the site address line 1.**

Line 3 displays a cursor.

4.3.3.4 Site Address Line 1

1. Enter the first line of the site address (maximum of 20 characters).

System Response

The address will appear on line 3.

2. Select ENTER.

System Response

Lines 1 and 4 of Figure 4-6 remain unchanged.

Line 2 reads: **Enter the site address line 2.**

Line 3 displays a cursor.

4.3.3.5 Site Address Line 2

1. Enter the second line of the site address (maximum of 20 characters). If there is none, leave Line 3 blank and select ENTER.

System Response

The address will appear on line 3.

2. Select ENTER.

System Response

Lines 1 and 4 of Figure 4-6 remain unchanged.

Line 2 reads: **Set the site city.**

Line 3 displays a cursor.

4.3.3.6 Site City

1. Enter the city (maximum of 20 characters).

System Response

The city will appear on line 3.

2. Select ENTER.

System Response

Lines 1 and 4 of Figure 4-6 remain unchanged.

Line 2 reads: **Set the site state, (2 character).**

Line 3 displays a cursor.

4.3.3.7 Site State

1. Enter the state (maximum of 2 characters).

System Response

The state will appear on line 3.

2. Select ENTER.

System Response

Lines 1 and 4 of Figure 4-6 remain unchanged.

Line 2 reads: **Set the site zip code.**

Line 3 displays a cursor.

4.3.3.8 Site Zip Code

1. Enter the zip code (maximum of 10 characters).

System Response

The zip code will appear on line 3.

2. Select ENTER.

System Response

Lines 1 and 4 of Figure 4-6 remain unchanged.

Line 2 reads: **Set the site phone #.**

Line 3 displays a cursor.

4.3.3.9 Site Phone Number

1. Enter the telephone number (maximum of 20 characters).

System Response

The telephone number will appear on line 3.

2. Select ENTER.

System Response

Lines 1 and 4 of Figure 4-6 remain unchanged.

Line 2 reads: **Set the site manager's name.**

Line 3 displays a cursor.

4.3.3.10 Site Manager's Name

1. Enter the site manager's name (maximum of 20 characters).

System Response

The manager's name will appear on line 3.

2. Select ENTER.

System Response

Lines 1 and 4 of Figure 4-6 remain unchanged.

Line 2 reads: **Site Identification.**

Line 3 displays a cursor.

4.3.3.11 Site Identification Number

This information is for factor use only. The site identification number is set by the manufacturer and cannot be changed in the field.

1. Enter the site identification number (maximum of 8 characters). This is the OEL8000II Controller Serial #.

System Response

The site identification number will appear on line 3.

2. Select ENTER.

System Response

Lines 1 and 4 of Figure 4-6 remain unchanged.

Line 2 reads: **Set Print Header Line #1.**

Line 3 displays a cursor.

4.3.3.12 Site Print Header

This feature allows you to create a 4-line header that will appear on hard copy printouts. This feature is preprogrammed by the manufacturer but may be changed in the field.

1. Enter Print Header for Line #1.

System Response

The Print Header for Line #1 will appear on line 3.

2. Select ENTER.

System Response

Lines 1 and 4 of Figure 4-6 remain unchanged.

Line 2 reads: **Set Print Header Line #2.**

Line 3 displays a cursor.

3. The system will repeat this process allowing you to enter up to four (4) header lines. Repeat the above instructions for each header line. To leave a blank line, just select ENTER. When the LCD displays: **Set Print Header Line #4**, enter a value (or leave it blank) and select ENTER.

System Response

Lines 1 and 4 of Figure 4-6 remain unchanged.

Line 2 reads: **Enter CITLD Enable Code.**

Line 3 displays a cursor.

4.3.3.13 CITLD Enable Code

Contact the manufacturer for additional information on this feature.

1. Enter the CITLD Enable Code provided by OMNTEC.

System Response

The CITLD Enable Code will appear on line #3.

2. Press the arrow beneath ENTER.

System Response

Lines 1 and 4 of Figure 4-6 remain unchanged.

Line 2 reads: **Set the Ullage Percentage (Max 95%).**

Line 3 displays a cursor.

4.3.3.14 Ullage Percentage

This value is factory preprogrammed at 90%

4.3.4 Tank Data

The Tank Submenu allows you to enter data for each tank. For systems with multiple tanks, repeat the following procedures for each tank.

Starting in Screen #1 of the SETUP Submenu, select TANK.

Note: To return to the MAIN Menu from the Tank Submenu, select EXIT and then press the MENU key. The LCD returns to Screen #1 of the MAIN Menu (see Figure 4-3a).

System Response

The screen will appear as in Figure 4-7a.

Line 1 remains unchanged.

Line 2 reads: **Enter the tank number, (1 – 8).**

Line 3 shows a cursor.

Line 4 has a new set of fields.

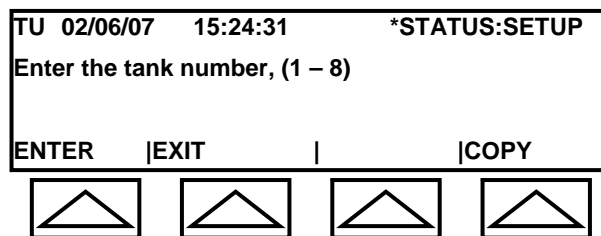

Fig. 4-7a: Tank Submenu

Field Descriptions

- ◆ ENTER – select this field to save entered data and to advance to the next screen.
- ◆ EXIT – returns to Screen #1 of the SETUP Submenu.
- ◆ COPY – select this field to copy data from one tank to another tank.

Copying Tank Data

When programming the first (or only) tank or multiple tanks that are different, start with *Section 4.3.4.1b – Tank Identification*. When programming two or more similar tanks, you can save time by copying data from a previously programmed tank. To copy tank data, begin with *Section 4.3.4.1a – Copying Tank Data*.

4.3.4.1a Copying Tank Data

When you have two or more similar tanks, you can use this procedure to copy data from a previously programmed tank. **Note that not all of the copied data may apply to the new tank. After copying, review all data and make changes where applicable.**



Failure to comply with recommendations may result in improper operation of system.

1. Enter the number of the tank to be programmed.

System Response

The tank number appears on line 3.

2. Select COPY.

System Response

The screen will appear as in Figure 4-7b.

Line 1 remains unchanged.

Line 2 reads: **Copy tank setting from ? Enter 1..8.**

Line 3 shows a cursor.

Line 4 shows ENTER and EXIT fields.

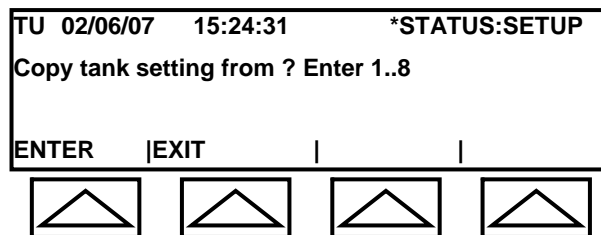

Fig. 4-7b: Copying Tank Data

3. Enter the number of the tank to be copied.

System Response

The tank number appears on line 3.

4. Select ENTER.

System Response

Lines 1 and 4 of Figure 4-7b remain unchanged.

Line 2 reads: **Tank Y has been copied from tank X.** (*X* and *Y* represent the tank numbers entered in Step 1 and Step 3, above)

Line 3 continues to display the number of tank being copied.

The LCD will display this screen for a few seconds then revert to the Tank Submenu (see Figure 4-7a).

5. Proceed to *Section 4.3.4.1b – Tank Identification* to review copied data and make

applicable changes.

4.3.4.1b Tank Identification

1. Enter the tank number.

System Response

The tank number appears on line 3.

2. Select ENTER.

System Response

The screen will appear as in Figure 4-7c.

Line 1 remains unchanged.

Line 2 reads: **Enable/Disable level probe, E/D.**

Line 3 shows current probe status (**E** or **D**).

Line 4 has a new set of fields.

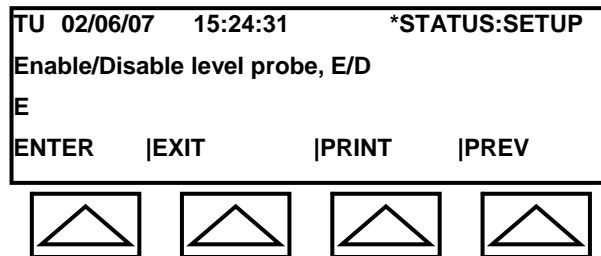

Fig. 4-7c: Tank Data

Field Descriptions

- ◆ ENTER – select this field to save entered data and to advance to the next screen.
- ◆ EXIT – returns to Screen #1 of the SETUP Submenu.
- ◆ PRINT – provides a hardcopy printout of Tank Data.
- ◆ PREV – returns to previous screen.

Note: All of the data entries that follow pertain to the tank number identified in this section.

4.3.4.2 Level Probe – Enable/Disable

This section permits you to enable or disable the level probe associated with the tank you identified in the previous section. Line 3 displays the currently programmed value. If you want to keep this value, skip to Step 3.

1. Press the **DEL** key to erase the old value.

System Response

Line 3 will become blank and show a blinking cursor.

2. Enter **E** for enable or **D** for disable.

Note: If any character other than E is entered, the system will automatically program the default value – D.

System Response

The character you entered will appear on line 3.

3. Select ENTER.

System Response

The screen will appear as in Figure 4-7c.

Lines 1 and 4 are the same

Line 2 reads: **Set the product type.**

Line 3 shows a cursor

4.3.4.3 Product Type

1. Enter the product type (maximum of 18 characters).

System Response

The product type will appear on line 3.

2. Select ENTER.

System Response

Lines 1 and 4 of Figure 4-7c remain unchanged.

Line 2 reads: **Set the coef. thermal expansion.**

Line 3 shows a cursor.

Note: When entering numerical values for physical criteria, use numbers and decimal points only, (no commas or spaces). Also, always measure and enter data based on specified units.

4.3.4.4 Coefficient of Thermal Expansion

1. Enter the coefficient of thermal expansion (maximum of 10 numerical characters).

Note: The system will automatically multiply the value entered by 10^{-5} (refer to Appendix A – Probes).

System Response

The coefficient of thermal expansion will appear on line 3.

2. Select ENTER.

System Response

Lines 1 and 4 of Figure 4-7c remain unchanged.

Line 2 reads: **Set the tank tilt, (In).**

Line 3 shows a cursor.

4.3.4.5 Tank Tilt

Note: The tank tilt was calculated in Section 2.1.3 – Tank Tilt.

1. Enter the tank tilt in inches (maximum of 10 numerical characters).

System Response

The tank tilt will appear on line 3.

2. Select ENTER.

System Response

Lines 1 and 4 of Figure 4-7c remain unchanged.

Line 2 reads: **Set product height? Enter 1=YES; 0=NO.**

Line 3 shows a cursor and the current value for the Product Null (e.g. **P.N. 1.002 (In)**).

4.3.4.6 Product Height

The product height and water height (see *Section 4.3.4.7 – Water Height*) procedures must be performed at the same time. For each tank, you will have to obtain a stick-reading of the product height and water height and enter their measured values into the system. The system will automatically calculate the Product Null and Water Null.

Important!

To ensure accurate calculations, you must perform the product height and water height measurements at the same time and immediately enter the values into the system (during this procedure product must be stagnant).



Failure to comply with recommendations may result in improper operation of system.

If you do not wish to enter values at this time, you can skip these sections (enter **0**)

and select ENTER; repeat for Water Height). You may choose to return to this section after you have finished the rest of the programming.

To enter values, do the following:

1. Obtain stick-readings of the product height and of water height (for water height, use a water paste on the stick).
2. Enter **1** and select ENTER.

System Response

Lines 1 and 4 of Figure 4-7c remain unchanged.

Line 2 reads: **Enter the product height, (In).**

Line 3 shows a cursor and the previously entered value for Product Height.

2. Enter the product height stick-reading (maximum of 10 numerical characters plus decimal point).

System Response

The product height will appear on line 3.

3. Select ENTER.

System Response

The system calculates the Product Null.

Lines 1 and 4 of Figure 4-7c remain unchanged.

Line 2 reads: **Set water height? Enter 1=YES; 0=NO.**

Line 3 shows a cursor and the current value for the Water Null (e.g. **W.N. 1.502 (In)**).

4.3.4.7 Water Height

The product height and water height procedures are performed at the same time. The water height stick-reading was obtained in the previous section.

Important!

Read and perform the procedure in Section 4.3.4.6 – Product Height, before performing this procedure.



Failure to comply with recommendations may result in improper operation of system.

1. Enter **1** and select ENTER.

System Response

Lines 1 and 4 of Figure 4-7c remain unchanged.

Line 2 reads: **Enter the water height, (In).**

Line 3 shows a cursor and the previously entered value for water height.

2. Enter the water height stick-reading that you obtained in the previous section (maximum of 10 numerical characters plus decimal point).

System Response

The water height will appear on line 3.

3. Select ENTER.

System Response

The system calculates the Water Null.

Lines 1 and 4 of Figure 4-7c remain unchanged.

Line 2 reads: **Set the probe thermistor: 1, 4, 5.**

Line 3 shows **5.**

4.3.4.8 Thermistor Type

This value has been factory programmed to 5 (default value). You may change the programming by finding the value on the probe label and entering it as follows:

1. Enter the thermistor type.

System Response

The thermistor type will appear on line 3.

2. Select ENTER.

System Response

Lines 1 and 4 of Figure 4-7c remain unchanged.

Line 2 reads: **Set the probe wire speed.**

Line 3 shows **9.000.**

4.3.4.9 Probe Wire Speed

This value has been factory programmed to 9.000 (default value). You may change the programming by finding the value on the probe label and entering it as follows:

1. Enter the probe wire speed.

System Response

The probe wire speed will appear on line 3.

2. Select ENTER.

System Response

Lines 1 and 4 of Figure 4-7c remain unchanged.

Line 2 reads: **Set the high water alarm point, (In).**

Line 3 shows **3.0**.

4.3.4.10 High Water Alarm Point

This value has been factory programmed to 3.0” (default value). If the tank’s water level should rise to this level, the high water alarm will be activated. The water level is detected by the lower float on the magnetostrictive probe.

To change the value, do the following:

1. Enter the high water alarm point in inches.

System Response

The high water alarm point will appear on line 3.

2. Select ENTER.

System Response

Lines 1 and 4 of Figure 4-7c remain unchanged.

Line 2 reads: **Set low/low product alarm point, % tank**

Line 3 shows **15**.

4.3.4.11 Low/Low Product Alarm Point

The value is a percentage of the tank capacity. If the tank’s product level drops to this level, the low/low product alarm will be activated. The factory programmed value is 15% (default value). The product level is detected by the upper float on the magnetostrictive probe.

To change the value, do the following:

1. Enter the low/low product alarm point in percent.

System Response

The low/low product alarm point will appear on line 3.

2. Select ENTER.

System Response

Lines 1 and 4 of Figure 4-7c remain unchanged.

Line 2 reads: **Set Delivery needed point, % tank (0=OFF).**

Line 3 shows a cursor and displays: (**0** to Disable).

4.3.4.12 Delivery Needed Alarm Point

The value is a percentage of the tank capacity. If the tank's product level drops to this level, the delivery needed alarm will be activated. The factory programmed value is 30% (default value).

To change the value, do the following:

Note: This value must be greater than the low/low alarm point.

1. Enter the delivery needed point percent (enter **0** to disable feature).

System Response

The delivery needed point will appear on line 3.

2. Select ENTER.

System Response

Lines 1 and 4 of Figure 4-7c remain unchanged.

Line 2 reads: **Set low product point, % tank.**

Line 3 shows **30** and displays: (**'0' to Disable**).

4.3.4.13 Low Product Point

The value is a percentage of the tank capacity. If the tank's product level drops to this level, the low product point will be activated. The factory programmed value is 0% (default value).

To change the value, do the following:

1. Enter the low product point in percent (enter **0** to disable feature).

System Response

The low product point will appear on line 3.

4.3.4.14 High Product Point

The value is a percentage of the tank capacity. If the tank's product level rises to this level, the high product point will be activated. The factory programmed value is 101% (default value).

To change the value, do the following:

1. Enter the high product point in percent (enter **101** to disable feature).

System Response

The high product point will appear on line 3.

4.3.4.15 High Product Warning Point

The value is a percentage of the tank capacity. If the tank's product level rises to this level, the high product warning point will be activated. The factory programmed value is 85% (default value).

To change the value, do the following:

1. Enter the high product warning point in percent.

System Response

The high product warning point will appear on line 3.

4.3.4.16 Overfill Product Alarm Point

The value is a percentage of the tank capacity. If the tank's product level rises to this level, the overfill product alarm will be activated. The factory programmed value is 85% (default value). The maximum programmable value is 90%.

To change the value, do the following:

1. Enter the overfill product alarm point in percent (enter **101** to disable feature).

System Response

The overfill product alarm point will appear on line 3.

4.3.4.17 High/High Product Alarm Point

The value is a percentage of the tank capacity. If the tank's product level rises to this level, the high/high product alarm will be activated. The factory programmed value is 90% (default value). The maximum programmable value is 95%.

1. Enter the high/high product alarm in percent.

System Response

The high/high product alarm will appear on line 3.

Note: Alarms and other system responses are discussed in Section 2.3 – Magnetostrictive (MTG) Probe.

4.3.4.18 Tank Diameter

The tank diameter is the tank height.

1. Enter the diameter of the tank in inches (maximum of 10 characters).

System Response

The tank diameter will appear on line 3.

2. Select ENTER.

System Response

Lines 1 and 4 of Figure 4-7c remain unchanged.

Line 2 reads: **Set the probe length for the tank, (In).**

Line 3 shows a cursor.

4.3.4.19 Probe Length

The probe length is the length of the magnetostrictive probe's shaft in inches.

1. Enter the probe length (see *Section 2.3.1 – MTG Probe Length*). You may enter up to 10 numerical characters.

System Response

The probe length will appear on line 3.

2. Select ENTER.

System Response

Lines 1 and 4 of Figure 4-7c remain unchanged.

Line 2 reads: **Set the tank capacity, (G).**

Line 3 shows a cursor.

4.3.4.20 Tank Capacity

1. Enter the volume tank capacity in gallons (maximum of 10 numerical characters).

System Response

The tank capacity will appear on line 3.

2. Select ENTER.

System Response

Lines 1 and 4 of Figure 4-7c remain unchanged.

Line 2 reads: **Set a vol. offset (G).**

Line 3 shows a cursor.

4.3.4.21 Volume Offset

Volume Offset is a calibration to compensate for consistent discrepancies that may be found between actual and displayed volume.

Important!

When initially programming the controller, leave the default value of zero (0).

1. Enter the volume offset in gallons (maximum of 10 numerical characters).

System Response

The volume offset will appear on line 3.

2. Select ENTER.

System Response

Lines 1 and 4 of Figure 4-7c remain unchanged.

Line 2 reads: **Enable/Disable/All Tanks, VLD test,E/D/A.**

Line 3 shows a cursor.

4.3.4.22 Automated VLD (Volume Leak Detection Test)

This feature is used for setting a specific time interval for running the VLD test. It can be run automatically every day, every week, or every month, at a specific time of the day.

Important!

Remember that the VLD test time is 4 hours long plus the dwell time. During this time the product level must remain constant.



Failure to comply may result in erroneous results.

1. Enter one of the following:

- ◆ Enter **E** to enable this feature.
- ◆ Enter **D** to disable this feature.
- ◆ Enter **A** to enable this feature for ALL tanks.

System Response

The selected option will appear on line 3.

Note: Even if you disable this feature you still must enter the subsequent screens that apply to this feature in order to proceed to the next programmable area.

2. Select ENTER.

System Response

Lines 1 and 4 of Figure 4-7c remain unchanged.

Line 2 reads: **Set interval, Monthly, Weekly, Daily, M/W/D.**

Line 3 shows a cursor.

3. Enter one of the following:

- ◆ Enter **M** for Monthly.
- ◆ Enter **W** for Weekly.
- ◆ Enter **D** for Daily.

System Response

The selected option will appear on line 3.

4. Select ENTER.

System Response

Lines 1 and 4 of Figure 4-7c remain unchanged.

Line 2 reads: **Set date, 1-28.**

Line 3 shows a cursor.

If you chose to run the test daily or weekly then this screen is irrelevant and Line 3 shows **XX**. In this case select ENTER to proceed to the next screen. If you chose to run the automatic VLD test on a monthly basis, then enter a number 1 to 28 corresponding to the day of the month that the VLD test should be conducted.

5. Enter one of the following:

- ◆ If you selected **W** or **D** in Step 3, select ENTER.
- ◆ If you select **M** in Step 3, enter a date and select ENTER.

System Response

Lines 1 and 4 of Figure 4-7c remain unchanged.

Line 2 reads: **Set day, 1-7 (Sun-Sat).**

Line 3 shows a cursor.

If you chose to run the test daily or monthly then this screen is irrelevant and Line 3 shows **X**. In this case select ENTER to proceed to the next screen. If you chose to run the automatic VLD test on a weekly basis, then enter a number 1 to 7 corresponding to the day of the week that the VLD test is to be run.

6. Enter one of the following:

- ◆ If you selected **D** or **M** in Step 3, select ENTER.
- ◆ If you select **W** in Step 3, enter a date and select ENTER.

System Response

Lines 1 and 4 of Figure 4-7c remain unchanged.

Line 2 reads: **Set daily test time, 00:00 – 23:59.**

Line 3 shows a cursor.

This screen is relevant to all test intervals. Enter the time of the day the test should be conducted. For example, enter 00.00 for midnight.

7. Enter the time of day.

System Response

The time of day will appear on line 3.

8. Select ENTER.

System Response

Lines 1 and 4 of Figure 4-7c remain unchanged.

Line 2 reads: **Set Sudden Loss Limit, (GPH).**

Line 3 shows a cursor.

4.3.4.23 Sudden Loss Limit

This value allows the system to distinguish between an actual leak and a sudden loss that may occur while running a VLD test. The number entered should be a value that would be too high to be considered a leak. An example would be someone pumping gas while a VLD test was in progress.

1. Enter the sudden loss limit (gallons per hour).

System Response

The sudden loss limit will appear on line 3.

2. Select ENTER.

System Response

Lines 1 and 4 of Figure 4-7c remain unchanged.

Line 2 reads: **Set the size of Table, Max 100.**

Line 3 shows a cursor.

4.3.4.24 Table Size

This procedure will divide the tank diameter (height) by the number of points you enter in this section. The system will calculate the height (in inches) for each point and prompt you to enter the tank volume for that level. Refer to the tank manufacturer's Dipstick Calibration Chart for volume at specific levels. **The higher the number you enter for table size, the greater the accuracy.**

1. Enter the table size (a numerical value from 1 to 100).

System Response

The table size will appear on line 3.

2. Select ENTER.

System Response

Lines 1 and 4 of Figure 4-7c remain unchanged.

Line 2 reads: **Set vol. for _____" (_____ in.) ACK = .**

Line 2 will show the actual level for the first point in both blank spaces. The first value is shown with a fraction, and the second value is shown as a decimal (example: **Set vol. for 3-5/8"**

(3.625 in.) ACK = .)

Line 3 shows a cursor.

3. Enter the volume for the level indicated (maximum of 10 characters). To enter a decimal point, press the **ACK** key.

System Response

The volume will appear on line 3.

4. Select ENTER.

System Response

The system will respond as in Step 2 displaying the level for the next point. Enter the volume and select ENTER. This will be repeated until entries have been made for the total number of points entered in Step 1.

After the volume for the last point has been entered, the LCD will return to Screen #1 of the SETUP Submenu (see Figure 4-5a).

If you have additional tanks to program, return to Section 4.3.4. If you have completed programming all of the tanks, proceed to Section 4.3.5.

4.3.5 Sensor Data

The Sensor Submenu allows you to configure (label), test, set priority level, and delete system sensors. It also allows you to program certain sensors.

If your system includes a temperature sensor (BX-TC-1), vapor sensor (BX-VS), or a humidity sensor, label them (see *Section 4.3.5.1.1 – Sensor Labeling*), and then program them (see *Section 4.3.5.1.4 – Temperature Sensor Programming* and *Section 4.3.5.1.5 – Vapor Sensor Programming*). Contact the manufacturer if your system includes a humidity sensor.

Starting in Screen #1 of the SETUP Submenu (see Figure 4-5a), select **SENSOR**.

*Note: To return to the MAIN Menu from the Sensor Submenu, select EXIT and then press the **MENU** key. The LCD returns to Screen #1 of the MAIN Menu (see Figure 4-3a).*

System Response

The screen will appear as in Figure 4-8a.

Lines 2 and 3 are blank.

Line 3 shows a cursor.

Line 4 has a new set of fields.

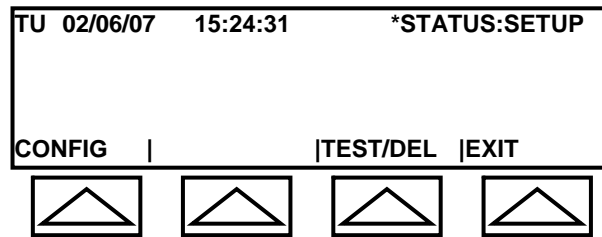

Fig. 4-8a: Sensor Submenu

Field Descriptions

- ◆ CONFIG – select this field to enter the Config Submenu. It searches for all system sensors and prompts you to provide labels.
- ◆ TEST/DEL – select this field to enter the Test Submenu. It allows for testing all system sensors, setting priority, and deleting sensors from the configuration.
- ◆ EXIT – select this field to return to Screen #1 of the SETUP Submenu.

Printing

While in the Sensor Submenu, you can obtain a hardcopy printout by pressing the **PRINT** key. This will also test each sensor and provide the results in the printout. The printout (see Figure 4-8b) provides the sensor number, serial number, part number, tank number, label number, priority, alarm, warning, and test results.

S#	P/N	LABEL	TEST
01	BXLS	T ?, Label #: 0 (S/N: 000064787)	P
02	BXPDS	T ?, Label #: 0 (S/N: 200064796)	P
03	BXUT1	T 1, Interstic#: 1 (S/N: 500064832)	P

S#= SENSOR NUMBER, P/N= PART NUMBER,
T#= TANK, S/N= SENSOR SERIAL NUMBER,
P=PASS, A=ALARM, F=FAIL, W=WARNING
NR= NO REPLY, H= HIGH PRIORITY

Figure 4-8b: Sensor Submenu Printout

4.3.5.1 Config (Sensor) Submenu

The following procedure applies when programming the controller for the first time.

Select CONFIG in the Sensor Submenu.

System Response

1. The system will search for system sensors. While searching, the LCD display will alternate between Figure 4-9a and Figure 4-9b.
2. Each time a sensor is found, the system will assign it a number and briefly display it on the LCD as illustrated in Figure 4-9c.
3. When the search is completed, the LCD will display the total number of sensors found as illustrated in Figure 4-9d.

Note: When selecting CONFIG during subsequent programming, Figure 4-9c will be displayed only if new sensors are found.

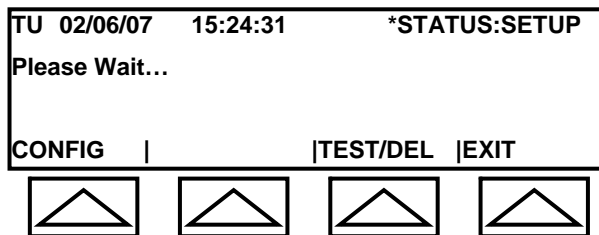

Fig. 4-9a: Config. – Searching Sensors

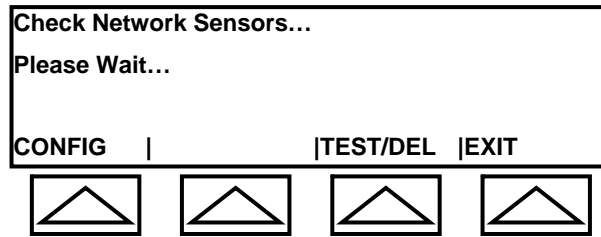

Fig. 4-9b: Config. – Searching Sensors

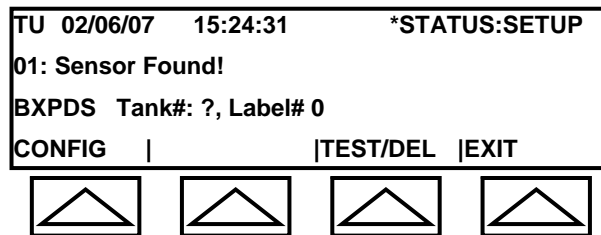

Fig. 4-9c: Config. – Finding Sensors

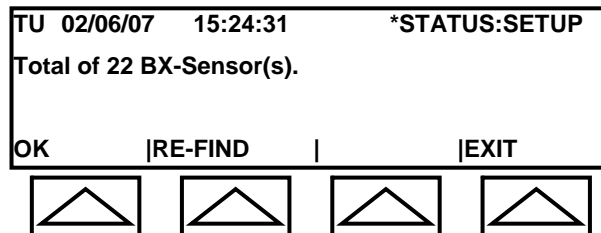

Fig. 4-9d: Config. – Search Results

Field Descriptions

- ◆ OK – displays the sensor labeling screen (see Figure 4-10a).
- ◆ RE-FIND – repeats the search for sensors. Use this function if one or more sensors on the system are not found.
- ◆ EXIT – returns to Screen #1 of the SETUP Submenu (see Figure 4-5a).

4.3.5.1.1 Sensor Labeling

The labeling screen provides label choices for each type of sensor. These appear as fields in Line 4 on the LCD (see Figure 4-9e). Table 4-1 identifies the labels that will appear for the different types of sensor.

Sensor	Available Labels (Fields in 4 th line of LCD)
BX-PDS BX-LS	Sump DbleWall Disp Other
BX-LV	HiLevel HiHiLevel CautLevel Other
BX-PDWF BX-LWF	Interstic Annular DbleWall Other
BX-VS	Vault Well Sump Other
BX-UT1	Interstic HiLevel LowLevel Other
BX-TC-1	Refrig Freezer Other
BX-LSR	Sump Disp Other

Table 4-1: Sensor Labels

The following procedure uses the BX-LS sensor as an example. Use this procedure as a guide when labeling the other types of sensors. Labeling instructions for temperature and vapor sensors are discussed in separate sections (see *Section 4.3.5.1.4 – Temperature Sensor Labeling* and *Section 4.3.5.1.5 – Vapor Sensor Labeling*).

1. Select OK in the Config. – Search Results Screen (see Figure 4-9d).

System Response

The Label Screen is displayed (see Figure 4-9e).

Line 1 remains unchanged.

Line 2 displays the assigned sensor number, sensor type, and sensor serial number.

Line 3 displays: **Need Location Label...**

Line 4 displays label options.

Note: Figure 4-9e will not be displayed for sensors that had already been labeled in previous programming. The Label Edit Screen (see Figure 4-9h) will be displayed instead allowing you to make edits (see Section 4.3.5.1.3 – Editing Labels).

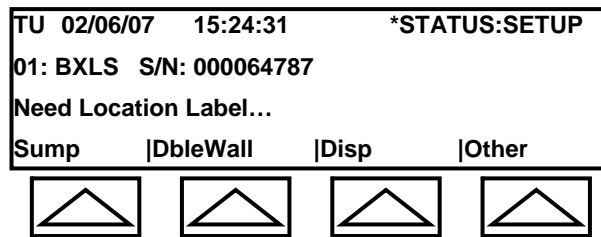

Fig. 4-9e: Label Screen

Note: You can use the CURSOR LEFT and CURSOR RIGHT arrow keys on the data keypad to scroll from sensor to sensor.

2. Select Sump.

System Response

The screen will appear as in Figure 4-9f.

Lines 1 and 2 remain unchanged.

Line 3 displays: **Tank# ?**, **Sump# ?**. DbleWall or Disp would be displayed instead of Sump had you selected one of these labels.

Line 4 has a new set of fields.

Note: Some sensors, such as the temperature sensor, will not prompt for a tank number.

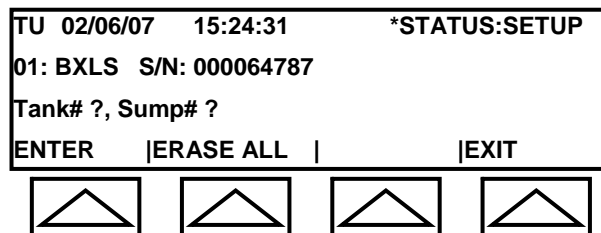

Fig. 4-9f: Entering Labels Screen

Field Descriptions

- ◆ ENTER – advances the cursor from Tank to Sump and then to the next sensor.
- ◆ ERASE ALL – erases all data entered on line 3. If no data was entered, the LCD displays the Label Screen (see Figure 4-9e).
- ◆ EXIT – returns to the Sensor Submenu (see Figure 4-8a).

3. Enter a tank number.

System Response

The tank number will appear on line 3.

4. Select ENTER.

System Response

The cursor moves to Sump (location label) on line 3.

5. Enter a sump number.

Note: This number is important if there is more than one sensor with the same tank number and same label.

System Response

The sump number will appear on line 3.

6. Select ENTER.

System Response

The Label Screen (see Figure 4-9e) will be displayed for the next sensor.

Line 1 remains unchanged.

Line 2 displays the sensor number, type, and serial number.

Line 3 displays: **Need Location Label...**

Line 4 displays the appropriate labels for the sensor (see Table 4-1).

7. Continue labeling the remaining sensors. After labeling the last sensor, select EXIT.

System Response

The Sensor Submenu (see Figure 4-8a) is displayed.

4.3.5.1.2 Other Label

In addition to the displayed labels, you can also choose Other to provide your own label.

1. Starting in the Label Screen (see Figure 4-9e), select Other.

System Response

The screen will appear as in Figure 4-9g.

Lines 1 and 2 remain unchanged.

Line 3 displays: **Location:** and the cursor.

Line 4 has a new set of fields.

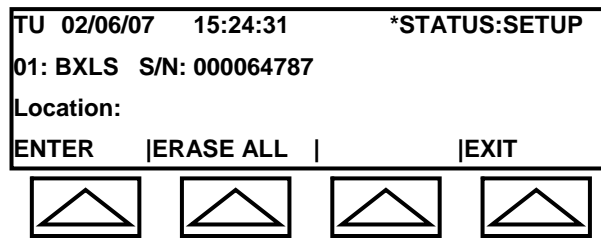

Fig. 4-9g: Other Label Screen

2. Enter the location using the keypad.

System Response

The location will appear on line 3.

3. Select ENTER.

System Response

The Label Screen (see Figure 4-9e) will be displayed for the next sensor.

Line 1 remains unchanged.

Line 2 displays the sensor number, type, and serial number.

Line 3 displays: **Need Location Label...**

Line 4 displays the appropriate labels for the sensor (see Table 4-1).

Important!

If your system includes a temperature sensor (BX-TC-1), vapor sensor (BX-VS), or humidity sensor, you must program them. Complete labeling all system sensors then proceed to the appropriate section below for programming instructions. Contact the manufacturer if your system includes a humidity sensor.

4.3.5.1.3 Editing Sensor Labels

When you select OK in the Config – Search Results Screen (see Step 1 in *Section 4.3.5.1.1 – Sensor Labeling*), the Label Screen (see Figure 4-9e) is displayed prompting you to select a label. If a sensor had already been labeled during previous programming, the Label Edit Screen (see Figure 4-9h) will be displayed instead allowing you to make edits.

To edit a previously labeled sensor, do the following:

1. Starting in the Sensor Submenu (see Figure 4-8a), select CONFIG.
2. After the system has completed searching for sensors, select OK in the Config. – Search Results Screen (see Figure 4-9d).

- Use the CURSOR LEFT or CURSOR RIGHT arrow key to search for the sensor to be edited.

System Response

The screen will appear as in Figure 4-9h.

Line 1 displays the day, date, time, and status.

Line 2 displays the sensor number, type, and serial number.

Line 3 displays the sensor label data

Line 4 displays ENTER, EDIT, and EXIT.

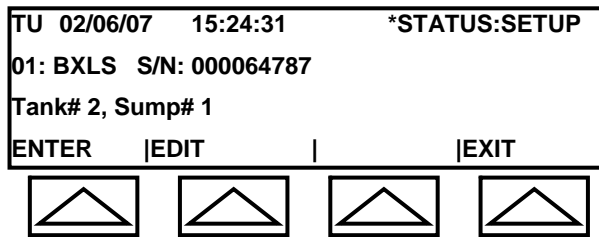

Fig. 4-9h: Label Edit Screen

Field Descriptions

- ◆ ENTER – advances LCD to the next sensor.
- ◆ EDIT – displays the Editing Screen Figure 4-9i).
- ◆ EXIT – returns to the Sensor Submenu (see Figure 4-8a).

- Select EDIT.

System Response

The screen will appear as in Figure 4-9i.

Lines 1, 2, and 3 remain unchanged.

Line 3 shows a cursor.

Line 4 replaces the EDIT field with an ERASE ALL field.

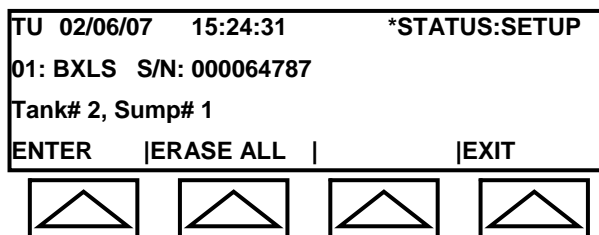

Fig. 4-9i: Edit Screen

Field Descriptions

- ◆ ENTER – advances cursor on line 3.
 - ◆ ERASE ALL – deletes displayed data.
 - ◆ EXIT – returns to the Sensor Submenu (see Figure 4-8a).
5. Select ERASE ALL to delete label values. Select ERASE ALL again to delete labeling.

4.3.5.1.4 Temperature Sensor Programming

The temperature sensor (BX-TC-1) can be used for monitoring the temperature in a refrigerator or freezer. If your system includes a temperature sensor, you already selected one of these location labels (see *Section 4.3.5.1.1 – Sensor Labeling*). In this section, you will set the levels for its control points. Refer to *Section 4.3.10.1.4 – Temperature (BX-TC) Sensor Activation* to enable and disable the control and alarm relays.

1. Starting in the Config. – Search Results Screen (see Figure 4-9d), select OK.
2. Select ENTER or use the CURSOR LEFT or CURSOR RIGHT arrow key to scroll through the sensors until you find the temperature sensor.

System Response

The Temperature Sensor Screen is displayed (see Figure 4-9j).

Line 1 remains unchanged.

Line 2 displays the sensor number, type, and serial number.

Line 3 displays the selected location (illustration shows Freezer) and current settings for Low (L), High (H), On, and Off.

Line 4 displays ENTER, EDIT, and EXIT.

Note: Label options such as those shown in Line 4 of Figure 4-9e, are displayed only for sensors where a label has not been assigned. When a label has already been assigned, Line 4 will appear as shown in Figure 4-9j.

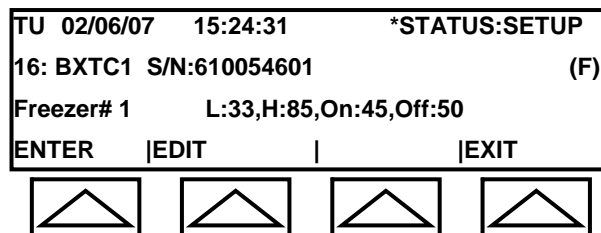

Fig. 4-9j: Temperature Sensor Screen

Field Descriptions

- ◆ ENTER – allows scrolling through sensors.
- ◆ EDIT – displays the edit screen.
- ◆ EXIT – returns to the Sensor Submenu (see Figure 4-8a).

3. Select EDIT.

System Response

The screen will appear as in Figure 4-9k.

Lines 1 and 2 remain unchanged.

Line 2 displays the sensor number, type, and serial number.

Line 3 displays the current settings for Low, Hi, On, and Off.

Line 4 has a new set of fields.

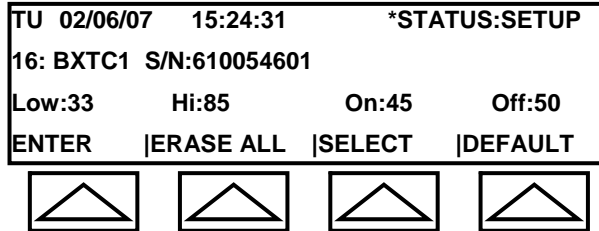

Fig. 4-9k: Temperature Sensor Edit Screen

Field Descriptions

- ◆ ENTER – select ENTER after entering a value using the data keypad.
- ◆ ERASE ALL – deletes entered data.
- ◆ SELECT – moves cursor to next value.
- ◆ DEFAULT – restores factory settings.

4. Use SELECT to move cursor to value to be changed.
5. Enter new value using data keypad and select ENTER.
6. Repeat Steps 4 and 5 for other values to be changed.

4.3.5.1.5 Vapor Sensor Programming

If your system includes a vapor sensor (BX-VS), you already selected one of the labels show in Table 4-1. In this section, you will set its alarm level.

1. Select TEST/DEL in the Sensor Submenu (see Figure 4-8a).

System Response

The screen will appear as in Figure 4-9l.

The system scrolls through the system sensors, tests each sensor, and displays the results.

Line 1 displays the serial number of the sensor being displayed.

Line 2 indicates the sensor number and its test results.

Line 3 displays the sensor type and location label.

Line 4 has a new set of fields.

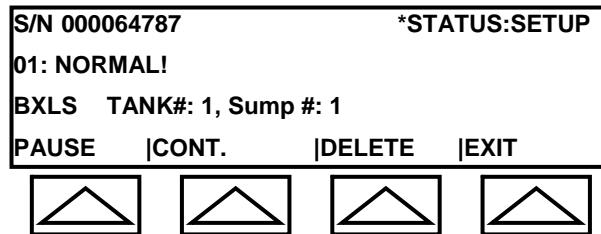

Fig. 4-9l: Test/Del Screen

Field Descriptions

- ◆ PAUSE – stops the automatic scrolling through sensors.
- ◆ CONT. – resumes automatic scrolling.
- ◆ DELETE – allows you to delete the sensor from the system configuration.
- ◆ EXIT – returns to the Sensor Submenu (see Figure 4-8a).

2. Select PAUSE when the vapor sensor is displayed.

System Response

The screen will appear as in Figure 4-9m (illustration shows that vault was the selected label).

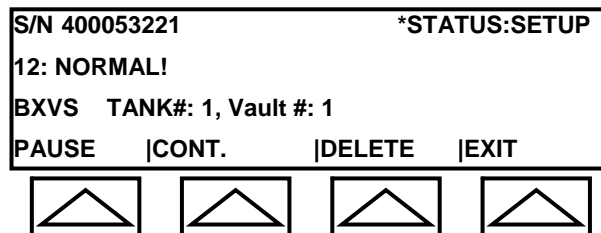

Fig. 4-9m: Vapor Sensor Screen

3. Select PAUSE two more times.

System Response

The screen will appear as in Figure 4-9n.

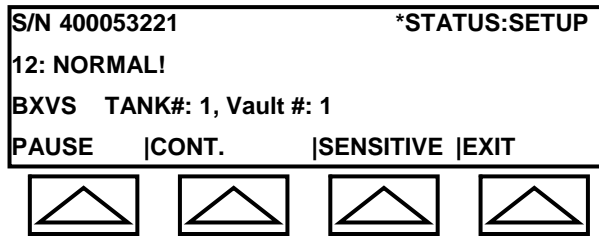

Fig. 4-9n: Vapor Sensor Screen

4. Select SENSITIVE.

System Response

The screen will appear as in Figure 4-9o.

Line 1 remains unchanged.

Line 2 displays the sensor number and shows that sensitivity range is 0 to 100.

Line 3 shows current sensitivity setting.

Line 4 has a new set of fields.

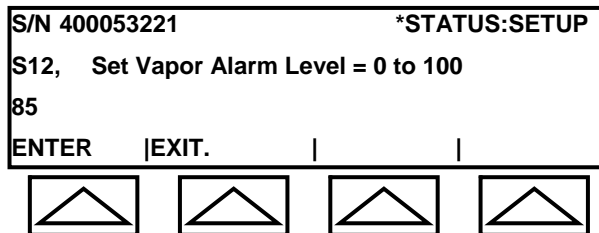

Fig. 4-9o: Vapor Sensor Screen

5. Enter a value between 0 and 100 (sensitivity decreases as the number increases).

System Response

The screen will appear as in Figure 4-9p. and then redisplay Figure 4-9n. Illustration shows 10 as sensitivity setting.

Lines 1 and 4 remain unchanged.

Lines 2 and 3 show new setting.

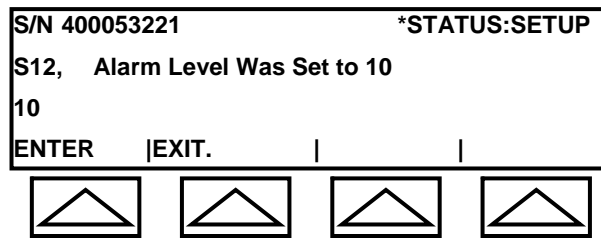

Fig. 4-14b: Serial Submenu

4.3.5.2 Test/Del (Sensor) Submenu

The Test/Del Submenu allows you to test each sensor, delete sensors from the configuration, and set a sensor's priority level.

4.3.5.2.1 Testing and Deleting Sensors

- Starting in the Sensor Submenu (see Figure 4-8a), select TEST/DEL.

System Response

The screen will appear as in Figure 4-10a.

The system scrolls through the system sensors, tests each sensor, and displays the results.

As the sensors scroll, an audible chirp is sounded.

Line 1 displays the serial number of the sensor being displayed.

Line 2 indicates the sensor number and its test results.

Line 3 displays the sensor type and location label.

Line 4 has a new set of fields.

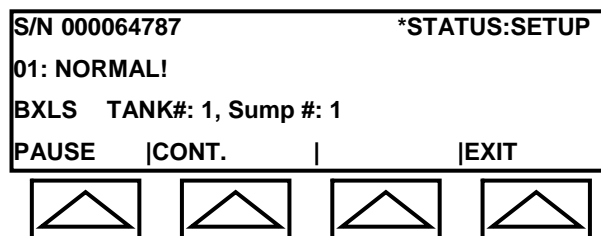

Fig. 4-10a: Test/Del Screen

Test Results

The three most common responses to sensor testing are:

- ◆ **NORMAL** – indicates the sensor is working and operating correctly.

- ◆ ALARM – the sensor is detecting an alarm condition. The LCD will provide an alarm description.
 - ◆ NO REPLY – system did not find the sensor or the sensor is malfunctioning.
2. To stop scrolling, select PAUSE. To resume scrolling, Select CONT.
 3. To delete a sensor, select PAUSE when the sensor is displayed.

System Response

The screen will appear as in Figure 4-10b.

Scrolling stops.

Lines 1, 2, and 3 remain unchanged.

Line 4 has a new set of fields.

Note: If line 4 displays PRIORITY instead of DELETE, select PAUSE one more time.

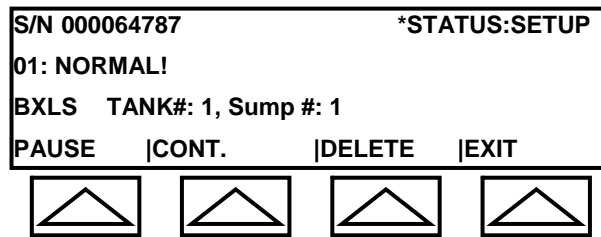

Fig. 4-10b: Paused Screen

Field Descriptions

- ◆ PAUSE – toggles the third field between DELETE and PRIORITY.
- ◆ CONT. – resumes automatic scrolling.
- ◆ DELETE – allows you to delete the sensor from the system configuration.
- ◆ EXIT – returns to the Sensor Submenu (see Figure 4-8a).

4. Select DELETE.

System Response

The screen will appear as in Figure 4-10c.

Line 1 remains unchanged.

Line 2 displays: **Delete S#01 ? Enter 0:NO, 1:YES.** (The illustration assumes sensor #01 is being deleted.)

Line 3 shows a cursor.

Line 4 has a new set of fields.

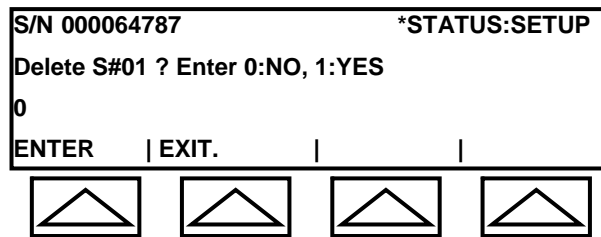

Fig. 4-10c: Delete Screen

Field Descriptions

- ◆ ENTER – enters value.
- ◆ EXIT – returns to scrolling through sensors (see Step 1).

5. Enter **1** using the data keypad then select ENTER.

System Response

The sensor is deleted and the system resumes scrolling through the remaining sensors (see Step 1).

4.3.5.2.2 Setting Sensor Priority

You can set a sensor's priority to Low or High.

1. Starting in the Sensor Submenu (see Figure 4-8a), select TEST/DEL.

System Response

The screen will appear as in Figure 4-10a.

The system scrolls through the system sensors, tests each sensor, and displays the results.

As the sensors scroll, an audible chirp is sounded.

Line 1 displays the serial number of the sensor being displayed.

Line 2 indicates the sensor number and its test results.

Line 3 displays the sensor type and location label.

Line 4 has a new set of fields.

2. To set a priority for a sensor, select PAUSE when the sensor is displayed.

System Response

The screen will appear as in Figure 4-10b.

Scrolling stops.

Lines 1, 2, and 3 remain unchanged.

Line 4 has a new set of fields.

3. Select PAUSE again.

System Response

The screen will appear as in Figure 4-10d.

Lines 1, 2, and 3 remain unchanged.

Line 4 replaces the DELETE field with the PRIORITY field.

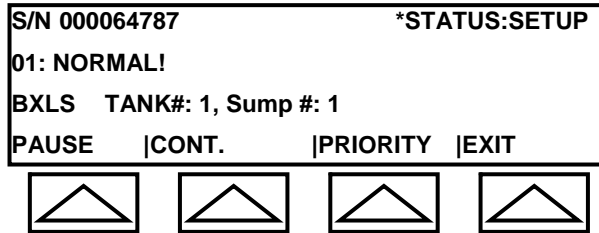

Fig. 4-10d: Priority Screen

4. Select PRIORITY.

System Response

The screen will appear as in Figure 4-10e.

Line 1 remains unchanged.

Line 2 displays: **Delete S#01 ? Enter 0:NO, 1:YES.** (The illustration assumes sensor #01 is being deleted.)

Line 3 shows a cursor.

Line 4 has a new set of fields.

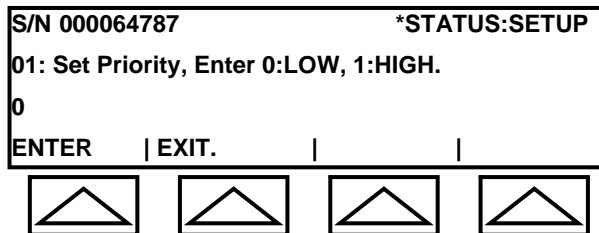

Fig. 4-10e: Priority Screen

5. Enter 1 using the data keypad then select ENTER.

System Response

The screen briefly displays Figure 4-10f and then redisplay the Test/Del Screen (see Figure 4-10a).

Lines 1 and 4 remain unchanged.

Line 2 displays: **01: Set Priority HIGH.** Had you entered 0 in Step 5, Line 3 would have displayed: **01: Set Priority LOW.**

Line 3 shows the entered value.

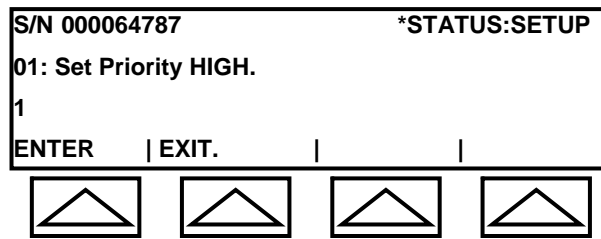

Fig. 4-10f: Priority Set Screen

4.3.6 Clearing Logs (Alarm, Drop, CITLD, and VLD)

The Alarm, Drop, and CITLD logs are accessed in Screen #2 of the SETUP Submenu (see Figure 4-5b), and the VLD log is accessed in Screen #3 of the SETUP Submenu (see Figure 4-5c). Select the MORE field on the bottom line of the LCD to advance screens.

*Note: To return to the MAIN Menu, press the **MENU** key. The LCD returns to Screen #1 of the MAIN Menu (see Figure 4-3a).*

The following procedure provides instructions for clearing logs. The Alarm Log is used for illustrative purposes.

1. Starting in Screen #1 of SETUP Submenu, select MORE to advance to Screen #2.
2. Select ALARM LOG.

System Response

The screen will appear as in Figure 4-11a.

Line 1 displays day, date, time, and status.

Line 2 indicates number of entries currently in log. It also instructs to enter **1** to clear the log.

Line 3 shows a cursor.

Line 4 has a new set of fields.

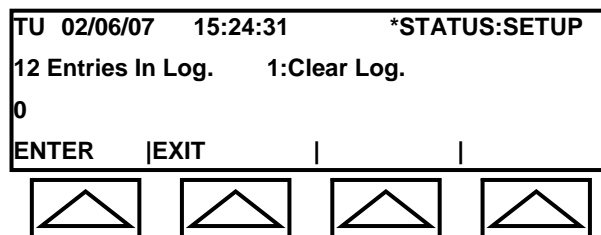

Fig. 4-11a: Clear Log Screen

Field Descriptions

- ◆ ENTER – enters value.
- ◆ EXIT – returns to Screen #2 of the SETUP Submenu (see Figure 4-5b). For the VLD Log, it returns to Screen #3 (see Figure 4-5c).

3. To clear the log, enter **1** using the data keypad.

System Response

The value will appear on line 3.

4. Select ENTER.

System Response

The screen will appear as in Figure 4-11b for a few seconds then the LCD will display Screen #2 (or Screen #3 for VLD) of the SETUP Submenu.

Lines 1, 3 and 4 remain unchanged.

Line 2 displays: **Alarm Log Empty**.

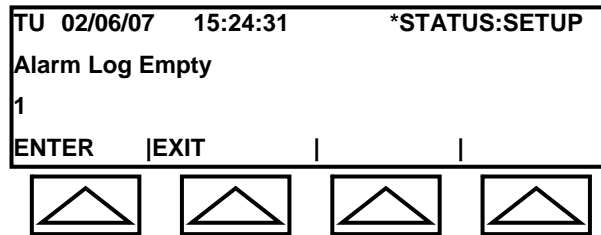

Fig. 4-11b: Log Cleared Screen

4.3.7 Shift Data

The Shift Submenu allows you to enter the number of shifts. It then prompts you for start and stop times.

Note: To return to the MAIN Menu from the Shift Submenu, select EXIT and then press the MENU key. The LCD returns to Screen #1 of the MAIN Menu (see Figure 4-3a).

1. Starting in Screen #1 of the SETUP Submenu, select MORE two times to advance to Screen #3.
2. Select SHIFT.

System Response

The screen will appear as in Figure 4-12.

Line 1 remains unchanged.

Line 2 displays: **Shift Print Enable/Disable (E/D)**.
 Line 3 displays the current programmed value.
 Line 4 has a new set of fields.

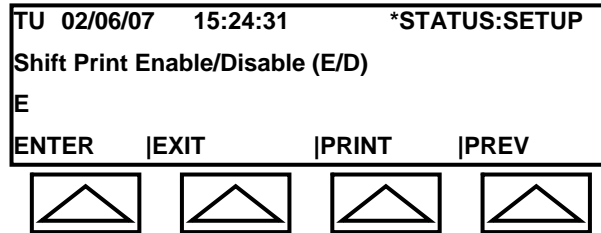

Fig. 4-12: Log Cleared Screen

Field Descriptions

- ◆ ENTER – enters value.
- ◆ EXIT – returns to Screen #1 of the SETUP Submenu (see Figure 4-5a).
- ◆ PRINT – provides a hardcopy printout of the Shift data.
- ◆ PREV – allows you to display the previous screen in the Shift Submenu.

3. Enter **E** for enable or **D** for disable.

Note: If any character other than E is entered, the system will automatically program the default value D.

System Response

The character you entered will appear on line 3.

4. Select ENTER.

System Response

Lines 1 and 4 of Figure 4-12 remain unchanged.

Line 2 displays: **Shift Open Time**.

Line 3 displays the currently programmed value.

5. Enter the Shift Open Time for Shift #1 in standard military time and select ENTER

System Response

Lines 1 and 4 of Figure 4-12 remain unchanged.

Line 2 displays: **Number of shifts (1-4)**

Line 3 displays the currently programmed value.

6. Enter the number of shifts (1-4) and select ENTER

System Response

Lines 1 and 4 of Figure 4-12 remain unchanged.

Line 2 displays: **Shift End Time 1**

Line 3 displays the currently programmed value.

7. Enter in standard military time the end time for shift #1 and select ENTER.

System Response

Lines 1 and 4 of Figure 4-12 remain unchanged.

Line 2 displays: **Shift End Time 2.**

Line 3 displays the currently programmed value.

8. The screen will prompt you to enter the end time for the remaining shifts. Selecting ENTER will advance you to the next shift. When the last end time is entered the screen will return to Screen #3 of the SETUP Submenu (see Figure 4-5c).

A printout will be provided at the end of each shift to reflect that shift's start volume, end volume, and delta volume for each tank connected to the system.

4.3.8 Remote Data

The Remote Submenu allows you to program the site alarm acknowledge time and, and it allows you to enable/disable the remote horn time out feature.

Note: To return to the MAIN Menu from the Remote Submenu, select EXIT and then press the MENU key. The LCD returns to Screen #1 of the MAIN Menu (see Figure 4-3a).

1. Starting in Screen #1 of the SETUP Submenu, select MORE two times to advance to Screen #3.
2. Select REMOTE.

System Response

The screen will appear as in Figure 4-13.

Line 1 remains unchanged.

Line 2 displays: **Set site alarm ack. time, ##### hour.**

Line 3 displays the default value 9999 hours or the currently programmed value.

Line 4 has a new set of fields.

Field Descriptions

- ◆ ENTER – enters value.
- ◆ EXIT – returns to Screen #1 of the SETUP Submenu (see Figure 4-5a).
- ◆ PRINT – provides a hardcopy printout of the Remote data.

- ◆ PREV – allows you to display the previous screen in the Remote Submenu.

4.3.8.1 Site Alarm Acknowledge Time

This feature serves as a snooze alarm. It allows you to set the length of time the controller will wait after an alarm has been acknowledged before sounding its horn again. An alarm is acknowledged by pressing the **ACK** key on the controller's front panel. This silences the horn. The horn will sound again after the programmed time if the alarm condition still exists.

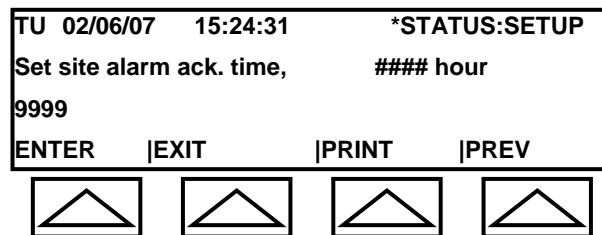

Fig. 4-13: Alarm Acknowledge Time Screen

1. To keep the current value, skip to Step 3. To change the value, press the **DELETE** key as often as necessary to erase the old number.

System Response

Line 3 will become blank and show a cursor.

2. Enter the time value in hours (maximum of 4 numerical characters).

System Response

The alarm acknowledge time in hours will appear on line 3.

3. Select ENTER.

System Response

Lines 1 and 4 of Figure 4-13 remain unchanged.

Line 2 displays: **Set remote horn timeout, ##### Min.**

Line 3 displays the currently programmed value.

4.3.8.2 Remote Horn Timeout

This is a time-out value for the RAS series remote annunciators. The annunciator's horn will respond to a high product alarm. If the horn is not shut off by pressing the annunciator's Horn Silence Switch, depressing the controller's **ACK** key, or correcting the alarm condition, the system will automatically shut off the annunciator's horn after this programmed time period. It does not affect the annunciator's LEDs.

*Note: This does not affect the controller's horn, which can only be shutoff by pressing the **ACK** key on the controller's panel or correcting the alarm condition.*

1. To keep the current value, skip to Step 3. To change the value, press the **DELETE** key as often as necessary to erase the old number.

Note: If no value has been previously programmed, Line 3 will be blank.

System Response

Line 3 will become blank and show a cursor.

2. Enter the time-out value in minutes (maximum of 4 numerical characters).

System Response

The time-out value will appear on line 3.

3. Select ENTER.

System Response

Lines 1 and 4 of Figure 4-13 remain unchanged.

Line 2 displays: **Set remote horn time enable, E/D.**

Line 3 displays the default value (**E**) or the currently programmed value.

4.3.8.3 Remote Horn Time Enable/Disable

This permits you to enable or disable the Remote Horn Timeout discussed in the previous section. If you select disable, the annunciator's horn will not time-out. In the event of a high product alarm, the horn will sound until the annunciator's reset button has been pressed, the controller's **ACK** key has been pressed, or the alarm condition has been corrected.

1. To keep the current value, skip to Step 3. To change the value, press the **DELETE** key as often as necessary to erase the old number.

System Response

Line 3 will become blank and show a cursor.

2. Enter **E** for enable or **D** for disable.

*Note: If any character other than **E** is entered, the system will automatically program the default value **D**.*

System Response

The character you entered will appear on line 3.

3. Select ENTER.

System Response

The LCD returns to returns to Screen #1 of the SETUP Submenu (see Figure 4-5a).

4.3.9 Comm

This section explains how to program the system's communications options.

Note: To return to the MAIN Menu from the Comm Submenu, select BACK and then press the MENU key. The LCD returns to Screen #1 of the MAIN Menu (see Figure 4-3a).

1. Starting in Screen #1 of the SETUP Submenu, select MORE three times to advance to Screen #4 (see Figure 4-5d).
2. Select COMM.

System Response

The screen will appear as in Figure 4-14a.

Line 1 remains unchanged.

Lines 2 and 3 display: **Make a Selection or Press Menu to Exit Setup.**

Line 4 has a new set of fields.

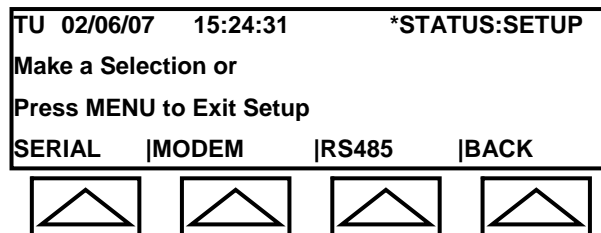

Fig. 4-14a: Comm Submenu

Field Descriptions

- ◆ SERIAL – for setting up COM1, COM2, and COM3 communications.
- ◆ MODEM –for setting up Auto Fax, Data Modem, and IP Modem.
- ◆ RS485 – for setting up RS485 communications.
- ◆ BACK – Returns to Screen #4 of the SETUP Submenu.

4.3.9.1 Serial

COM1 is used by the factory to download operating software for external devices (i.e., CM250 generator monitoring device, remote digital displays, etc.). COM2 is also used for external devices. COM3 is the most commonly used option for serial

(RS232) communications.

Select SERIAL to setup COM1, COM2, and COM3.

System Response

The screen will appear as in Figure 4-14b.

Line 1 remains unchanged.

Lines 2 and 3 are blank.

Line 4 provides the communications options.

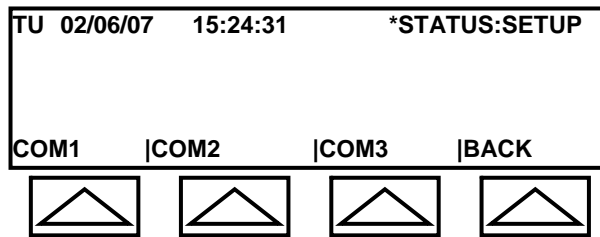

Fig. 4-14b: Serial Submenu

4.3.9.1.1 COM1

1. Select COM1 in the Serial Submenu (see Figure 4-14b).

System Response

The screen will appear as in Figure 4-14c.

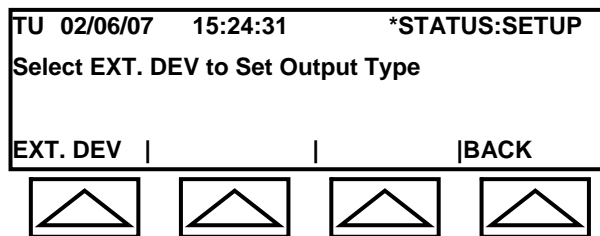

Fig. 4-14c: COM1

2. Select EXT DEV.

Contact manufacturer for additional information on this feature.

System Response

The screen will appear as in Figure 4-14d.

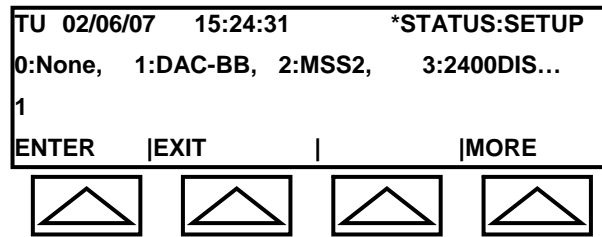

Fig. 4-14d: COM1 – Ext. Dev.

3. Select MORE to view additional options in second screen.

Note: Select MORE again to return to the first screen.

System Response

Lines 1, 3, and 4 remain unchanged..

Line 2 displays additional options: **4:9600DIS, 5:r200 DATA.**

4. Enter a number and select ENTER.

System Response

The LCD displays the Serial Submenu (see Figure 4-14b).

Lines 1 and 4 remain unchanged.

Lines 2 and 3 display: **Make a Selection or Press Menu to Exit Setup.**

4.3.9.1.2 COM2

1. Select COM2 in the Serial Submenu (see Figure 4-14b).

System Response

The screen will appear as in Figure 4-14e.

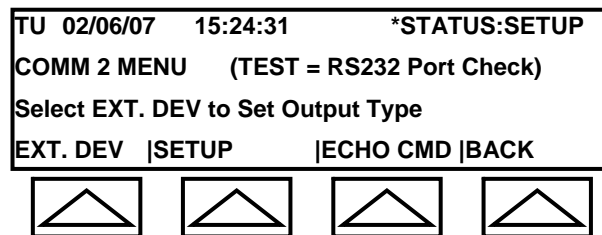

Fig. 4-14e: COM2

2. To perform RS232 Port Check, press the **TEST** key.

System Response

The screen will appear as in Figure 4-14f.

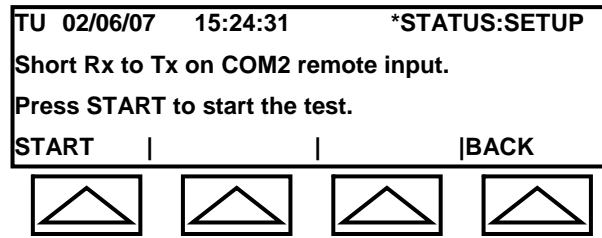

Fig. 4-14f: COM2

3. Use a jumper to jump the receive and transmit wires on COM2 (Pin 2 and pin 3 on the 9 pin D type connector located on the left side of the OEL8000II enclosure).
4. Select START. This runs the Loop Back Test.

System Response

The LCD will display the test results.

“COM2 Loopback test passed (or failed)”

5. Select one of the options on Line #4.

4.3.9.1.2.1 Ext. Dev

Contact manufacturer for additional information on this feature.

1. Select EXT DEV.

System Response

The screen will appear as in Figure 4-14g.

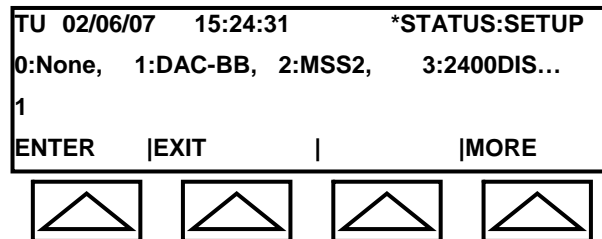

Fig. 4-14g: COM2 – Ext. Dev.

2. Select MORE to view additional options in second screen.

System Response

Lines 1, 3, and 4 remain unchanged..

Line 2 displays additional options: **4: CM250(4), 5: CM250(5), 6: 9600DIS...**

3. Select MORE to view additional options in third screen.

Note: Select MORE again to return to the first screen.

System Response

Lines 1, 3, and 4 remain unchanged..

Line 2 displays additional options: **7: REMOTE CONTROL, 8: PRINTER.**

4. Enter a number and select ENTER.

System Response

The LCD displays the Serial Submenu (see Figure 4-14b.

Lines 1 and 4 remain unchanged.

Lines 2 and 3 display: **Make a Selection or Press Menu to Exit Setup.**

4.3.9.1.2.2 Setup

1. Select SETUP

System Response

The screen will appear as in Figure 4-14h.

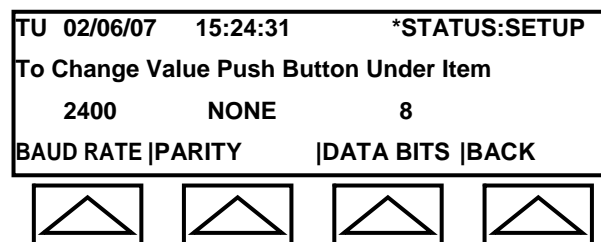

Fig. 4-14h: COM2 – Setup

Field Descriptions

- ◆ BAUD RATE – select to scroll through Baud Rate values.
- ◆ PARITY –select to scroll through: NONE, EVEN, ODD..
- ◆ DATA BITS – toggles between 7 and 8.
- ◆ BACK – Returns to Figure 4-14e.

2. Select one more fields on Line 4 and set to required values.

4.3.9.1.2.3 Echo Cmd

This feature allows the display of all incoming remote commands and part of the response string on the OEL8000II's display.

All incoming characters following the Control-A (start of command character) will be shown on the 3rd line of the display. Thirteen characters from the response string will also be displayed on the right side of the display. To turn on the echo command function (see Figure 4-14e), select (toggle) the arrow under ECHO CMD. The label will change to "ECHO ON". Exit setup by pressing the menu button.

4.3.9.1.3 COM3

The COM3 port is used to retrieve tank/sensor data or to change the settings in the OEL8000II. (Default Baud Rate: 9600)

1. Select COM3 in the Serial Submenu (see Figure 4-14b)

System Response

The screen will appear as in Figure 4-14i.



Fig. 4-14i: COM3

2. To perform RS232 Port Check (Loopback Test), see *Section 4.3.9.1.2 – COM2*, Step 2.
3. To Setup, see *Section 4.3.9.1.2.2 – Setup*.
4. Select ECHO CMD to toggle between ECHO ON and ECHO OFF, see *Section 4.3.9.1*.
5. To setup security, select SECURITY.

System Response

The screen will appear as in Figure 4-14j.

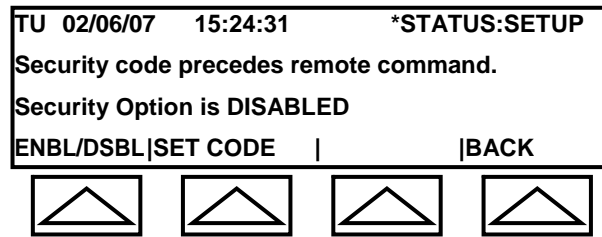

Fig. 4-14j: COM3 -- Security

- a. Select ENBL/DSBL to toggle between Enable and Disable.
- b. Select SET CODE to set a security code.

System Response

The screen will appear as in Figure 4-14k.

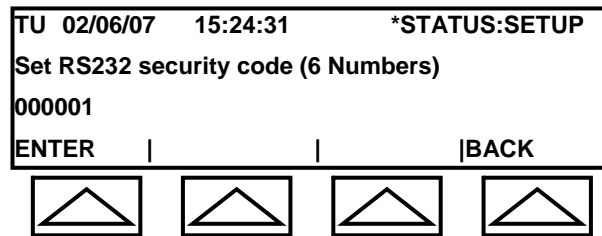

Fig. 4-14k: COM3 -- Security

- c. Enter a 6-digit numerical code using the data keypad and select ENTER.
- d. Select BACK to return to previous screen.

4.3.9.2 Modem

Select MODEM in the Com Submenu (see Figure 4-14a).

System Response

The screen will appear as in Figure 4-14l.

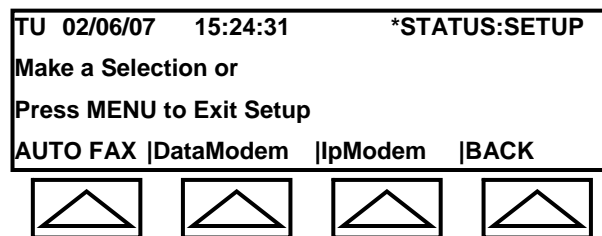

Fig. 4-14l: Modem Submenu

This feature allows you to enter telephone numbers for AUTOFAX and DATAMODEM and allows you to enter IP address for the IP modem

Use DATAMODEM for OMNTEC PC software or other PC based terminal program communications. Use AUTOFAX to send reports to a fax machine. The IP Modem uses an IP address for transmitting data.

Note: DATAMODEM and AUTOFAX cannot be enabled at the same time. Enable one or the other.

Using IpMODEM, the system allows you to select up to 8 IP addresses for transmitting the same data.

4.3.9.2.1 Autofax and Datamodem

1. Select AUTOFAX or DATAMODEM in the Modem Submenu.

System Response

The screen will appear as in Figure 4-14m.

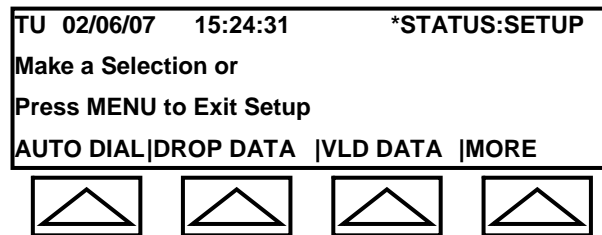

Fig. 4-14m: Telephone Number Entry

2. Select MORE to view additional options in second screen.

Note: Select MORE again to return to the first screen.

System Response

Lines 1, 2, and 3 remain unchanged..

Line 4 displays additional options: **ALRM DATA, SHIFT, BACK, MORE.**

Field Descriptions

- ◆ AUTO DIAL – allows you to enter up to 8 telephone numbers to be used for transmitting data.
- ◆ DROP DATA – allows you to select up to 8 of the telephone numbers entered in AUTO DIAL for transmitting Drop Data.
- ◆ VLD DATA – allows you to select up to 8 of the telephone numbers entered in AUTO DIAL for transmitting VLD Data.

- ◆ ALRM DATA – allows you to select up to 8 of the telephone numbers entered in AUTO DIAL for transmitting Alarm Data.
 - ◆ SHIFT DATA – allows you to select up to 8 of the telephone numbers entered in AUTO DIAL for transmitting Shift Data.
 - ◆ BACK – returns to previous screen.
 - ◆ MORE – advance to next screen or back to first screen.
3. In the first screen, select AUTODIAL.

System Response

The screen will appear as in Figure 4-14n.





TU 02/06/07		15:24:31		*STATUS:SETUP		
Enter Phone 1. (, = Pause)						
Phone #:						
NEXT		,		CLEAR		BACK
						

Fig. 4-14n: List Telephone Numbers

4. Enter the first telephone number and select NEXT. You will be prompted for the next telephone number. The system will assign a sequence number to be used in the following steps. Use CLEAR to erase the telephone number and the equal sign (=) to enter a pause before dialing the next number.
5. In the Modem Submenu (see Figure 4-14l), select DROP DATA, VLD DATA, ALARM DATA, or SHIFT DATA.

System Response

The screen will appear as in Figure 4-14o (illustration shows DROP DATA).

Line 3 shows a cursor for enter telephone number sequence assigned in previous step.





TU 02/06/07		15:24:31		*STATUS:SETUP		
Enter Phone #'s to Call with Drop Data						
#'s to Call:						
CLEAR						BACK
						

Fig. 4-14o: Select Telephone Numbers

6. For each telephone number to be dialed, enter the sequence number that was assigned in the previous step. Repeat this step for the other data types.

4.3.9.2.2 Ip Modem

This procedure allows you transmit the same data as discussed in *Section 4.3.9.2.1 – Autofax and Datamodem* using IP addresses instead of telephone numbers.

Using the same procedure as above, list all of the IP addresses in AUTODIAL and then select them for the different data types.

The IpModem has a third screen that can be accessed by selecting MORE allows you to enable/disable IP callout.

1. Select IpModem in the Modem Submenu.
2. List IP addresses and select data types as you did for Autofax and Datamodem in the previous section.
3. For the final step, while in Screen #2, select MORE.

System Response

The screen will appear as in Figure 4-14p (illustration shows DROP DATA).

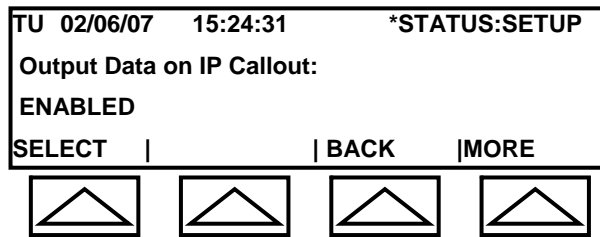

Fig. 4-14p: IP Callout Enable/Disable

4. Choose SELECT to toggle between ENABLED and DISABLED.
5. Select BACK to return to previous screen or select MORE to return to Figure 4-14m.

4.3.9.3 RS485

1. Select RS485 in the Com Submenu (see Figure 4-14q).

System Response

The screen will appear as in Figure 4-14q.

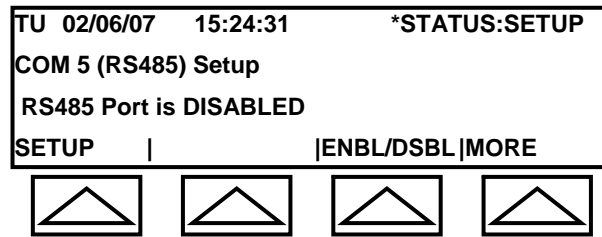

Fig. 4-14q: RS485 Submenu

- To setup the RS485, select SETUP

System Response

The screen will appear as in Figure 4-14r.

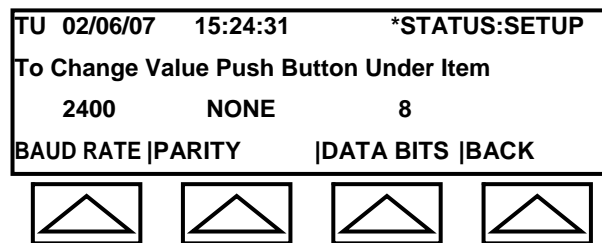

Fig. 4-14r: RS485 – Setup

Field Descriptions

- ◆ BAUD RATE – select to scroll through Baud Rate values.
- ◆ PARITY –select to scroll through: NONE, EVEN, ODD.
- ◆ DATA BITS – toggles between 7 and 8.
- ◆ BACK – returns to Figure 4-14q.

- Select one more fields on Line 4 and set to required values.
- In the RS485 Submenu (see Figure 4-14q) select ENBL/DSBL to toggle between enable and disable.

4.3.10 Int Brd

This section explains how to program the system's interface boards. Installation is discussed in *Appendix F – Interface Boards*.

Note: To return to the MAIN Menu from the Int Brd Submenu, select BACK and then press the MENU key. The LCD returns to Screen #1 of the MAIN Menu (see Figure 4-3a).

The controller has six slots inside the upper right corner for holding interface boards.

When you select INT BRD, the system performs a search and displays on the LCD the slot number and the interface board found in that slot. All interface boards are programmed the same with the exception of the remote annunciator board (IB-RAS). It is factory programmed and cannot be selected here. To change its parameters, you must enter the tank programming section.

Pressing the PRINT key will provide a hardcopy printout of all interface board data for this system. Installation instructions for interface boards are provided *Appendix F – Interface Boards*.

1. Starting in Screen #1 of the SETUP Submenu, select MORE three times to advance to Screen #4 (see Figure 4-5d).
2. Select Int Brd.

System Response

The screen will appear as in Figure 4-15a.

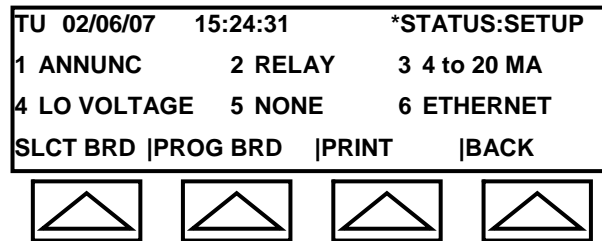

Fig. 4-15a: System Interface Boards

Field Descriptions

- ◆ SLCT BRD – allows you to choose a board by moving the cursor each time it is selected.
- ◆ PROG BRD – displays the PROG BRD submenu to program the selected board.
- ◆ PRINT – provides a hardcopy printout of all interface board data for this system.
- ◆ BACK – returns to Screen #4 of the SETUP Submenu (see Figure 4-5d).

4.3.10.1 Programming the IB-RB2 Relay Board

Each relay board has four relays. This section allows you to select each relay and program the conditions that activate it. Each relay can have multiple inputs. You may choose a tank (probe) condition and enable or disable it, or you may choose a sensor and enable or disable it.

1. Starting with the System Interface Boards Screen (see Figure 4-15a) Select SLCT BRD to move the cursor until it rest on the desired board. (For this illustration, we choose Slot #2 – the relay board).
2. Select PROG BRD.

System Response

The screen will appear as in Figure 4-15b (illustrates programming relay interface board in slot #2).

Line 1 is unchanged.

Line 2 displays the slot number and board for the interface board selected in Step 3.

Line 3 displays the relay output number.

Line 4 has a new set of fields.

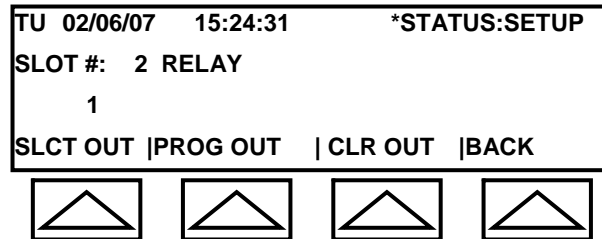

Fig. 4-15b: Programming Interface Board

Field Descriptions

- ◆ SLCT OUT – allows you to change the relay output number (1 – 4).
- ◆ PROG OUT – programs the selected relay output.
- ◆ CLR OUT – clears all selections for selected output.
- ◆ BACK – returns to previous screen.

3. Select SLCT OUT until desired relay (1 – 4) is displayed.

Note: Each relay board has 4 relays. SLCT OUT allows you select one of the four relays for programming.

System Response

Line 3 shows selected relay number.

4. Select PROG OUT.

System Response

The screen will appear as in Figure 4-15c (illustrates programming relay #1 of interface board in slot #2).

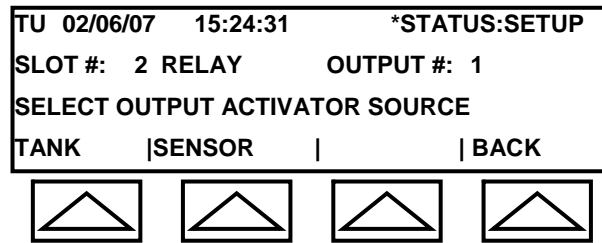

Fig. 4-15c: Programming Relay Board

Field Descriptions

- ◆ TANK – selects tank as the activator source and displays tank conditions.
- ◆ SENSOR – selects sensor as the activator source and displays tank conditions.
- ◆ BACK – Returns to previous screen.

5. Proceed to Step 6 of the appropriate subsection, below to complete programming for tank, non-product distinguishing sensor, product distinguishing sensor, or temperature sensor (BX-TC).

4.3.10.1.1 Tank Activation

Note: Continued from Section 4.3.10 – Int Brd.

6. For tank, select TANK.

System Response

The screen will appear as in Figure 4-15d.

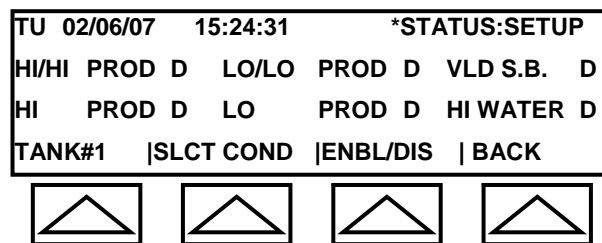

Fig. 4-15d: Tank Activator

Field Descriptions

- ◆ TANK# – selects tank number. The number is displayed in the tank field on line 4.
- ◆ SLCT COND – moves the cursor to the desired condition.
- ◆ ENBL/DIS – enables or disables the selected condition.
- ◆ BACK – returns to previous screen.

- a. Select TANK# until the desired tank number is displayed in the field.
- b. Select SLCT COND until the cursor rests on the desired condition.
- c. Select ENBL/DIS to enable or disable the condition.

4.3.10.1.2 Sensor Activation (non-product distinguishing)

Note: Continued from Section 4.3.10 – Int Brd.

Note: Sensor selected for activating relays must be labeled (see Section 4.3.5.1.1 – Sensor Labeling).

6. For sensor select SENSOR.

System Response

The screen will appear as in Figure 4-15e (non-product sensor).

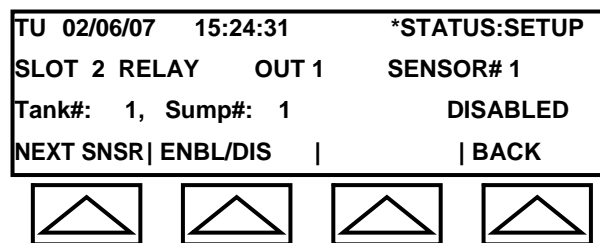

Fig. 4-15e: Sensor (Non-Product Distinguishing) Activator

Field Descriptions

- ◆ NEXT SNSR – scrolls through the sensors.
 - ◆ ENBL/DIS – enables or disables the selected sensor.
 - ◆ BACK – returns to previous screen.
- a. Select NEXT SNSR until the desired sensor number is displayed in line 2.
 - b. Select ENBL/DIS to enable or disable the sensor.

4.3.10.1.3 Sensor Activation (product distinguishing)

Note: Continued from Section 4.3.10 – Int Brd.

6. If the sensor selected in Step 6 was a product distinguishing sensor, then water and fuel options would appear (see Figure 4-15f).

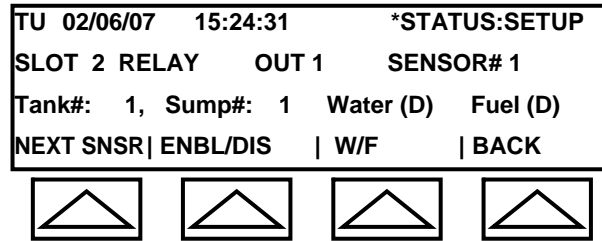

Fig. 4-15f: Sensor (Product Distinguishing) Activator

7. Toggle W/F to select water or fuel and then toggle ENBL/DIS to enable or disable each option.

4.3.10.1.4 Temperature (BX-TC) Sensor Activation

Note: Continued from Section 4.3.10 – Int Brd.

6. For temperature sensor select SENSOR.

System Response

The screen will appear as in Figure 4-15g.

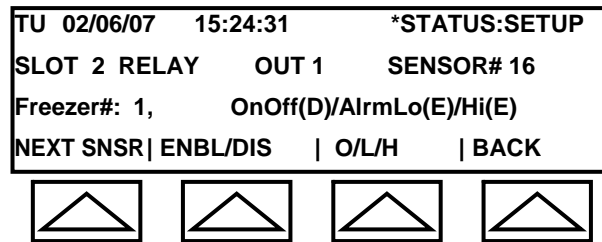

Fig. 4-15g: Temperature Sensor Activator

Both conditions, OnOff AlrmLo or AlrmHi, cannot be used at the same time.

Field Descriptions

- ◆ NEXT SNSR – scrolls through the sensors.
 - ◆ ENBL/DIS – enables or disables the selected sensor.
 - ◆ O/L/H – scrolls through OnOff, Alarm Lo, and Alarm Hi.
 - ◆ BACK – returns to previous screen.
- a. Select NEXT SNSR until the desired temperature sensor number is displayed in line 2.
 - b. Select O/L/H to choose OnOff, AlrmLo, or Hi.
 - c. Select ENBL/DIS to enable or disable the selected option.

On/Off changes the relay's state, and Alarm Lo/Alarm Hi are alarm levels.

Note: OnOff cannot be enabled if Alarm Lo or Hi is enabled. To enable both, you must use different relays.

4.3.10.2 Programming the IB-C420 Board

In this procedure, you select a channel that will provide an analog output representing the volume or height of a selected tank.

1. Starting in the System Interface Boards Screen (see Figure 4-15a), select SLCT BRD to position the cursor on **4 to 20MA**.
2. Select PROG BRD.

System Response

The screen will appear as in Figure 4-15h.

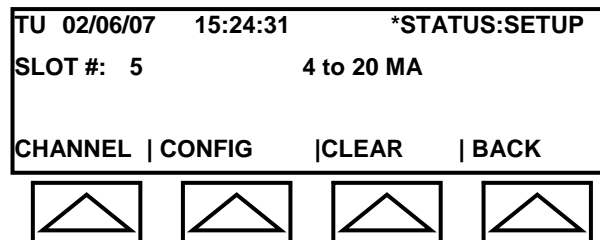

Fig. 4-15h: IB-C420

Field Descriptions

- ◆ CHANNEL – scrolls through the channel numbers (1 – 4).
 - ◆ CONFIG – proceeds to configuration screen.
 - ◆ CLEAR – clears entries.
 - ◆ BACK – returns to previous screen.
3. Select CHANNEL to choose a channel number. Refer to IV-C420 wiring diagram for proper channel number.
 4. Select CONFIG to accept the selected channel number.

System Response

Lines 1, 2, and 3 remain the same.

Line 4 displays fields: ASSIGN, CAL 20 MA, CAL 4 MA, BACK.

Note: CAL 20 MA and CAL 4 MA are for factory use only.

5. Select ASSIGN.

System Response

Line 1 remains the same.

Lines 2 and 3 are blank.

Line 4 displays fields: MAG TANK and BACK.

6. MAG TANK allows you to scroll through the system tanks. Select MAG TANK to choose a tank (probe) number.

System Response

Lines 1, 2, and 3 remain the same.

Line 4 displays fields: MAG TANK, VOL/HGT, BACK.

7. Select to VOL/HGT to choose volume or height.

IB-C420 interface boards are factory calibrated. Consult manufacturer for additional calibration instructions.

4.3.10.3 Programming the IB-12V Low Voltage Board

The IB-12V provides eight low voltage outputs. Programming procedures are the same as for the IB-RB2 (see *Section 4.3.10.1 – Programming the IB-RB2 Relay Board*).

4.3.10.4 Programming the IB-NET Board

See *Appendix F – Interface Boards* for installation and configuration instructions.

4.3.11 Report

This section allows you to obtain a hardcopy printout of the system parameters..

Note: To return to the MAIN Menu from the Report Submenu, select EXIT and then press the MENU key. The LCD returns to Screen #1 of the MAIN Menu (see Figure 4-3a).

1. Starting in Screen #1 of the SETUP Submenu, select MORE three times to advance to Screen #4 (see Figure 4-5d).
2. Select REPORT.

System Response

The screen will appear as in Figure 4-16.

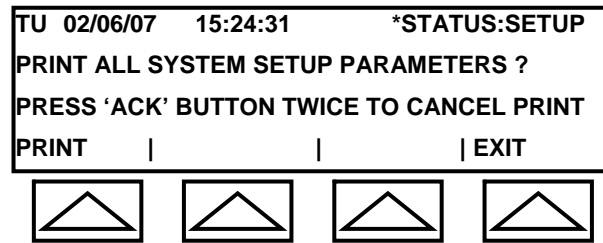

Fig. 4-16: Report

3. Select PRINT to obtain printout.

4.3.12 Units

This section allows you to select English units (e.g., inches and gallons) or metric units (e.g., cm and Liter).

*Note: To return to the MAIN Menu from the Units Submenu, select EXIT and then press the **MENU** key. The LCD returns to Screen #1 of the MAIN Menu (see Figure 4-3a).*

1. Starting in Screen #1 of the SETUP Submenu, select MORE four times to advance to Screen #5 (see Figure 4-5e).
2. Select UNITS.

System Response

The screen will appear as in Figure 4-17.

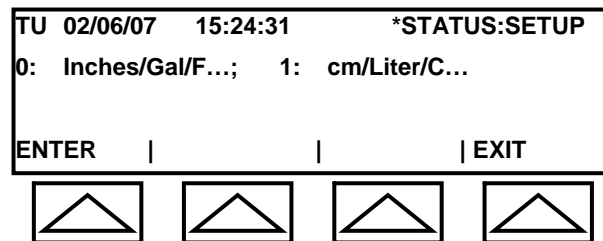

Fig. 4-17: Units

3. Using the data keypad, enter **0** to select English units or **1** to select metric units.

System Response

Line 3 shows the entered number.

4. Select ENTER.

System Response

The value is saved and the LCD returns to Screen #5 (see Figure

4-5e).

4.3.13 Language

This field appears in Screen #5 (see Figure 4-5e). It is reserved for future use.

Section 5 Procedures

5.1 Loopback Test

See *Section 4.3.9.1.2 – COM2 & COM3* for the Loopback Test procedure.

5.2 Setting Product and Water Height (Calibration)

The product and water height should be performed at the same time. For procedures, see *Section 4.3.4.6 – Product Height* and *Section 4.3.4.7 – Water Height*.

5.3 On Demand VLD Testing

Refer to the OEL8000II Owners Manual

5.4 Remote Testing of RAS Annunciator

Refer to the OEL8000II Owners Manual

5.5 Replacing Controller Batteries

The controller has two internal batteries. When replacing, always replace both batteries at the same time and always use CR2032.

1. Open the controller panel and remove power.



Failure to remove power when working on system can result in personal injury, death, or equipment damage.

2. Use a #10 torque drive to remove three screws securing the intrinsic cover. There are two screws on the outside and one screw on the inside of the cover.
3. Carefully remove the intrinsic cover.

4. Remove and replace the batteries one-at-a-time. Lift the spring clip to remove the battery.
5. Replace the intrinsic cover and secure with the three screws.

5.6 Troubleshooting Sensors

The following provides troubleshooting procedures for two conditions.

5.6.1 Condition #1

The system goes into alarm (horn sounds and ALARM LED illuminates), and the LCD displays: **SENSORS – NO REPLY – BUS ALARM**.

1. Measure approximately 12 Vdc. On JP26 use pins 1 & 4; on JP25 use pins 5 & 8.
2. If voltage is not present, remove the sensor connector and test for 12 Vdc on the corresponding pins on the motherboard connector (JP25 or JP26).

If voltage is good, the sensor is pulling the voltage down.

If voltage is missing from motherboard, fuses are blown.

Contact manufacturer with results to obtain additional instructions.

5.6.2 Condition #2

The system goes into alarm and the LCD shows: **NO REPLY**. This can occur when one or more sensors are not replying. The sensor or wiring may be defective.

Bring the sensor directly to the controller and connect it to the sensor input on the motherboard. If the system still shows no reply for the sensor, then the sensor is most likely defective. However, if the sensor is replying, then the wiring may be the problem.

Important!

Always remove power before removing or making connections or performing any other work inside the controller



Failure to comply can create an electric shock or explosion hazard causing death, personal injury, or property damage.

5.7 Troubleshooting Probe Guide

This section contains probe troubleshooting procedures. Refer to Figure 5-1b and 5-1c.

The two probe input connectors (JP24 and JP224) are located on the lower right side of the motherboard inside the intrinsically safe area. The tank numbers are indicated on the motherboard. For example, tank 1 uses the first two input on the right side of the connector. The other tanks run from right to left (see Figure 5-1a).

Connector: JP24								Connector: JP224							
Tank T8		Tank T7		Tank T6		Tank T5		Tank T4		Tank T3		Tank T2		Tank T1	
16	15	14	13	12	11	10	9	8	7	6	5	4	3	2	1
+	-	+	-	+	-	+	-	+	-	+	-	+	-	+	-

Fig. 5-1a: Probe Inputs (Inside Intrinsically Safe Area)

The probe cable should be Belden 8761, which is a two-conductor shielded cable with drain wire. The white wire should be connected to the positive and the black and drain wires should be the negative. The polarity is indicated on the motherboard just below the input connector.

1. Open the controller input and the intrinsically safe cover to expose the probe and sensor input connectors.
2. Check for any loose wire or connections and correct, if necessary.
3. Proceed to the applicable subsection, below.

5.7.1 Condition #1 – Status: High Water

System incorrectly indicates a high water level.

1. Remove probe from tank.
2. Move water float to bottom of probe and product float to middle of float. Observer reading on controller's LCD.
 - a. If the controller shows proper reading, the water float must be replaced.
 - b. If status still shows high water reading, water null may be incorrect. Correct, if necessary (see *Section 4.3.4.6 – Product Height* and *Section 4.3.4.7 – Water Height*).
3. The final test is to switch probes at the tank.

5.7.2 Condition #2 – Status: Timeout Error on all Probes

System shows timeout error on all probes.

1. Measure 28 Vdc at tp 30 (see Figure 5-1b).
 - a. If low or no voltage is present, proceed to Step 2.
 - b. If measurement is ok, check for pulsating dc voltage at each probe input on JP224 and JP24 connectors (see Figure 5-1a). Record results and contact manufacturer.
2. Power down the controller, disconnect probe connectors at JP224 and JP24, power up the controller, and measure 28 Vdc at tp 30 (see Figure 5-1b).

Always remove power before removing or making connections inside controller



Failure to comply can create an electric shock or explosion hazard causing death, personal injury, or property damage.

- a. If low or no voltage is present, motherboard is defective.
- b. If voltage is present, measure resistance across the plus (+) and negative (-) terminals for each probe (see Figure 5-1a) and record readings. Readings should be in high megaohms. A low resistance measurement indicates a problem with the probe or wiring. Contact manufacturer.

Probe resistance measurements are made with their connectors disconnected from the controller's motherboard.

5.7.3 Condition #3 – Status: Timeout Error on one Probe

System shows timeout error for one of the probes.

1. Switch defective probe with a good probe at controller's connector (see Figure 5-1a).
 - a. If timeout error is eliminated, the controller is suspect.
 - b. If the timeout error still exists, the problem may be with the probe or wiring. Proceed to Step 2.
2. Switch probes at tank (see Figure 5-1c).
 - a. If timeout error is eliminated, the original probe is defective.
 - b. If the timeout error still exists, the wiring is suspect.

5.7.4 Condition #4 – Status: Incorrect Product Level

System shows incorrect reading for product level.

This problem can be caused by a stuck float. Try to correct the problem with the following measures:

1. Press reset button **s1** on the motherboard. If no change, go to the next step.
2. Try to move float with tank gauging stick. If no change, go to the next step.
3. Switch probes.

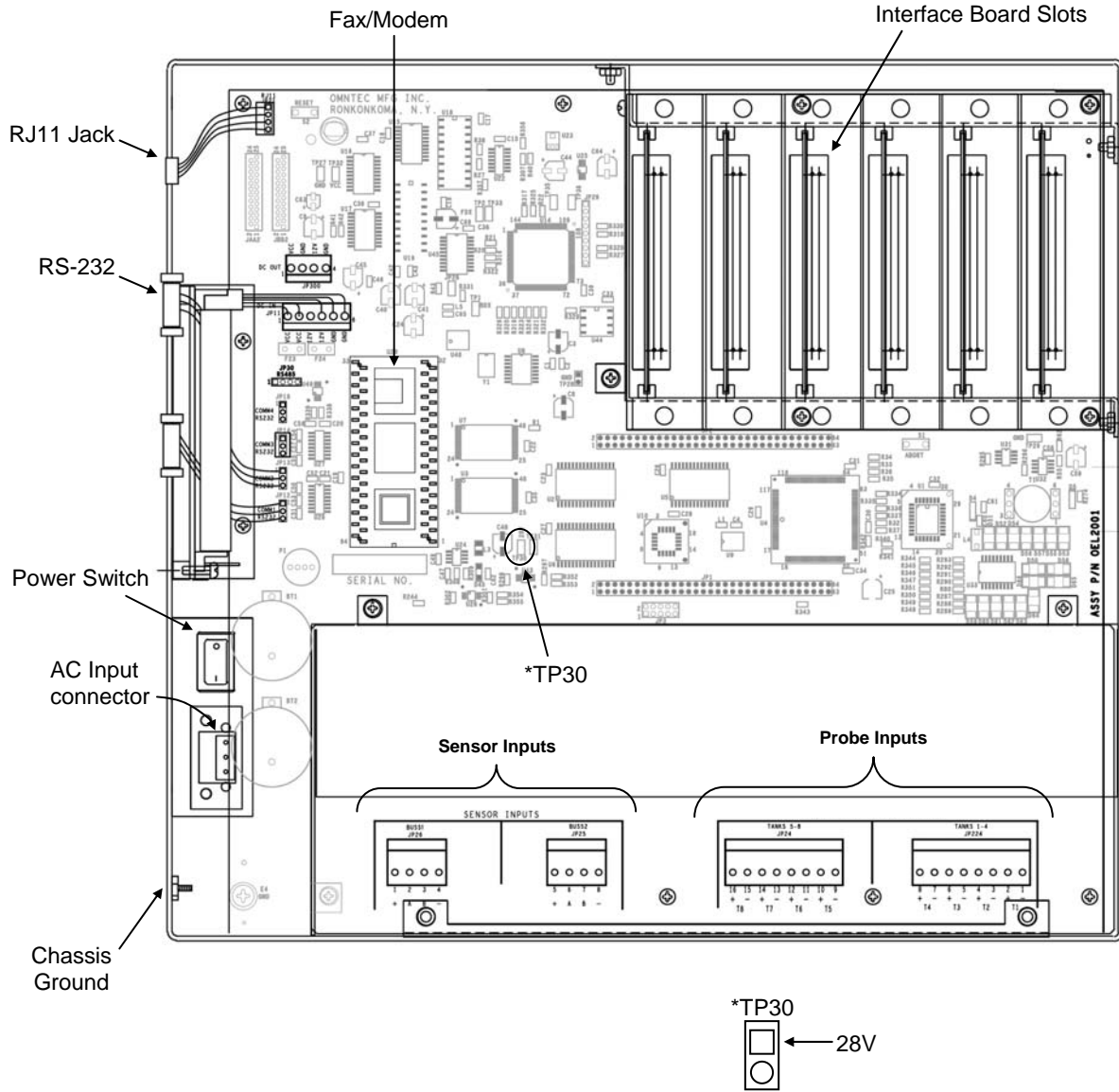

Fig. 5-1b: Controller Motherboard

CAUTION
EXTENSION CABLE from MTG probe to OEL8000II must be OMNITEC EC-2 or BELDEN #8761

CAUTION
 Probe must be lowered slowly until the probe foot touches the tank bottom. Sudden impact may result in damage to probe or tank.

CAUTION
 Floats must not be allowed to drop down shaft during installation. May result in damage to probe. Floats must slowly be lowered to the base of the shaft before insertion.

Note: Before Probe Installation
 1. Take a level reading at the probe riser with a gauge stick and record the information for system set-up.
 2. Record wire speed and probe length on top of probe for system set-up

④ **TIGHTEN CAP AND WIRE INTO JUNCTION BOX**

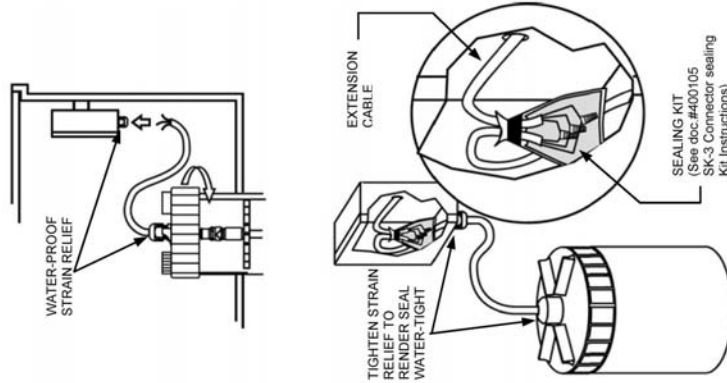

③ **FIT WIRE INTO RISER CAP**

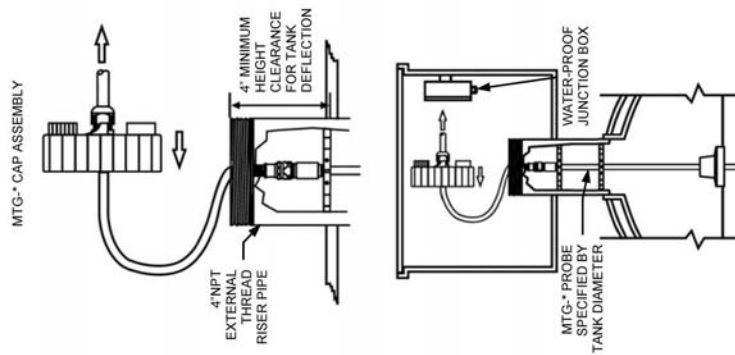

② **LOWER PROBE INTO TANK**

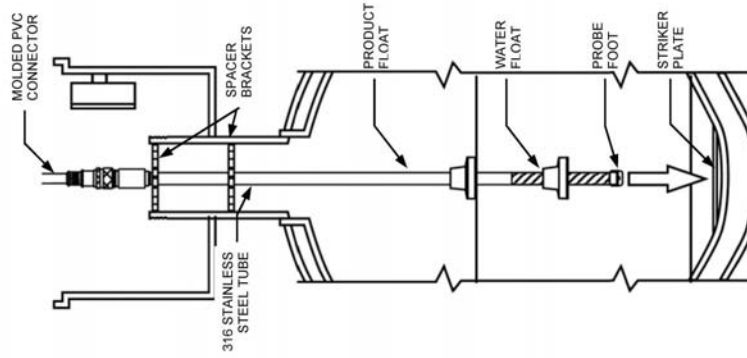

① **INSERT PROBE INTO RISER**

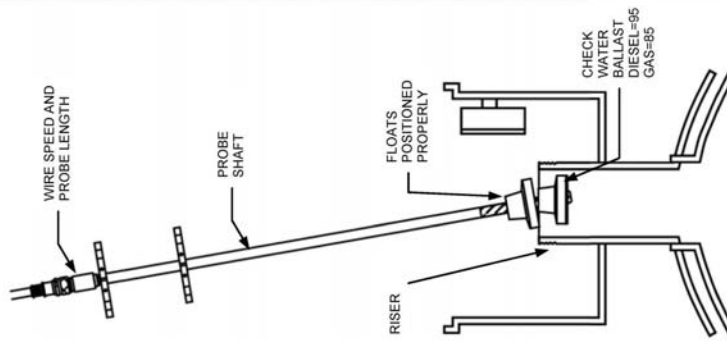

Fig. 5-1c: Probe Installation

5.8 Programming CLD

CLD allows you to perform Continuous Leak Detection, and is primarily used for leak testing sump (see Figure 5-2e) and dispenser (see Figure 5-2f) containment areas.

Entering Site Data

1. Program location information as follows (see *Section 4.3.2 – Entering the Security Code* and *Section 4.3.3 – Site Name*):
 - a. Starting in the MAIN Menu, select SETUP and enter the security code. The default code is **000000**.
 - b. Select Location, enter a site name and select ENTER. At the next screen select EXIT. This returns you to Screen #1 of the SETUP Submenu.

Note: This information will be changed prior to testing a new site.

Programming Probes

2. Program (Enable/Disable) MTG-Probe (see *Section 4.3.4 – Tank Data*).
 - a. Starting in the MAIN Menu, select SETUP and enter the security code. The default code is **000000**.
 - b. Select TANK, enter the probe number (up to 4 for each test) to edit the settings, then select ENTER.
 - c. ENABLE the probe to turn it on or DISABLE the probe to turn it off, and then select ENTER. Important: If you are using only two probes, then only the two probes that are connected should be enabled.
 - d. Enter the Product Type such as SUMP 1 DIESEL, or any text to describe the location of the tested area. A maximum of 20 characters can be entered to identify which sump correlates to this probe number. Select ENTER then select EXIT.
 - e. Repeat (starting at Step b) for each additional connected probe. Be sure that all probe inputs that are connected are disabled.
 - f. Press the **MENU** key to return to the MAIN Menu.

Confirming Enabled Probes

3. Starting in the MAIN, press the PRINT key to confirm all enabled MTG-probes are responding properly.

Performing CLD Test

4. Perform CLD test as follows:
 - a. Starting in the MAIN Menu, select MORE five times to advance to Screen #6. Select CLD. The following is displayed:

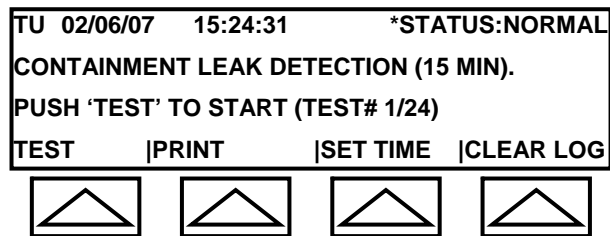

Fig. 5-2a: CLD Submenu

The bottom line of the CLD Submenu provides the following features:

- ◆ TEST – starts the test and enters TEST Submenu.
 - ◆ PRINT – prints test results for up to 4 probes (see Figure 5-2d).
 - ◆ SET TIME – allows you to set how long to run the test in the SET TIME Submenu.
 - ◆ CLEAR LOG – deletes contents of log.
- b. Select SET TIME. The LCD displays the SET TIME Submenu (see Figure 5-2b).

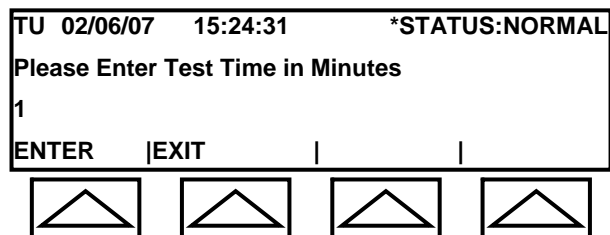

Fig. 5-2b: Set Time Submenu

The bottom line of the SET TIME Submenu provides the following features:

- ◆ ENTER – enter the testing time using the data keypad then select ENTER. LCD returns to the CLD Submenu (see Figure 5-2a).
- ◆ EXIT – returns to the CLD Submenu.

- c. Use the data keypad to enter the test time in minutes then select ENTER. The LCD returns to the previous screen (see Figure 5-2a).

Note: To return to the previous screen without entering a test time, select EXIT.

- d. Select TEST. Testing begins and the LCD displays the TEST Submenu (see Figure 5-2c) where the results are displayed.

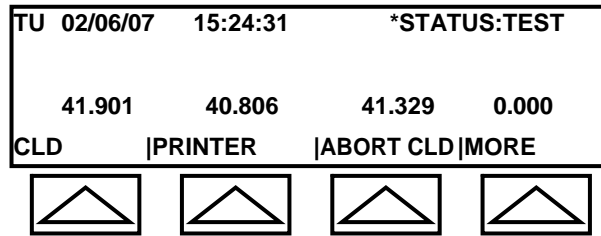

Fig. 5-2c: Test Submenu

The bottom line of the TEST Submenu provides the following features:

- ◆ CLD – to abort testing, select CLD then select ABORT CLD.
- ◆ PRINTER – displays a submenu that allows you set the print direction. The choices are: no actions, paper, LCD, comm2, and comm3.
- ◆ ABORT CLD – allows you to terminate testing. First select CLD then select ABORT CLD. The LCD returns to Screen #6 of the MAIN Menu.
- ◆ MORE –Allows you to advance through the screens in the MAIN Menu while testing is taking place.

- e. When test ends, the LCD will return to the CLD Submenu (see Figure 5-2a).

Note: During testing, if losses after 15 minutes are less than 0.002 inches, a passed test is reported. For losses greater than 0.002 inches, a failed test is reported. If there is a rise in the liquid level during testing, an inconclusive increase report will result.

Change Screen Reading to 3 Decimal Places

5. To toggle screen between 2 decimal (1/100) and 3 decimal (1/1000) places, do the following.
 - a. Starting in Screen #1 of the MAIN Menu, select STATUS.
 - b. Select MORE until the level reading in inches is displayed.
 - c. Press **5** on the data keypad and release.

- d. Press **5** again, hold screen changes, and then release. The LCD will display the number decimal places.

```
Name: ABC Company
Addr: 56 Main St.
Addr;
City, State, Zip
Hometown, NY 12345
Site Manager:
J.T.
Phone:
(555) 555-1234
Identification #:
01234567
May 03, 2007 10:18:30 AM
- CONTAINMENT LEAK DETECTION
Start Time      TH 05/03/07 10:03:30
End Time        TH 05/03/07 10:18:30
Probe #1
Sump Diesel Turbine
Start Height           29.798(In)
End Height             29.798(In)
PASS:                  0.000(In)
Probe #2
Sump Gas Turbine
Start Height           31.300(In)
End Height             30.297(In)
FAIL:                  0.003(In)
.
.
.
```

Fig. 5-2d: Sample CLD Report

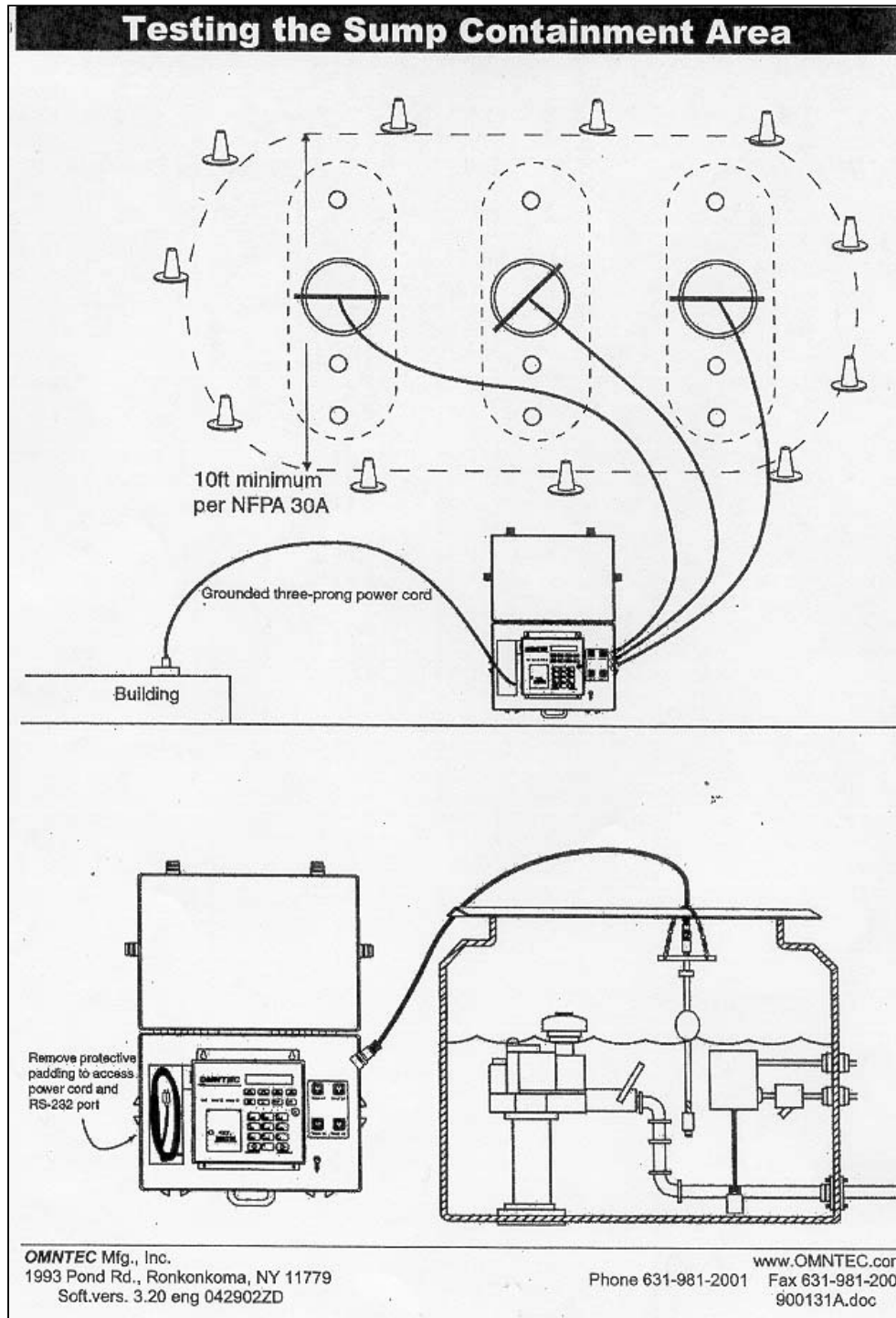

Fig. 5-2e: Sump Containment Area

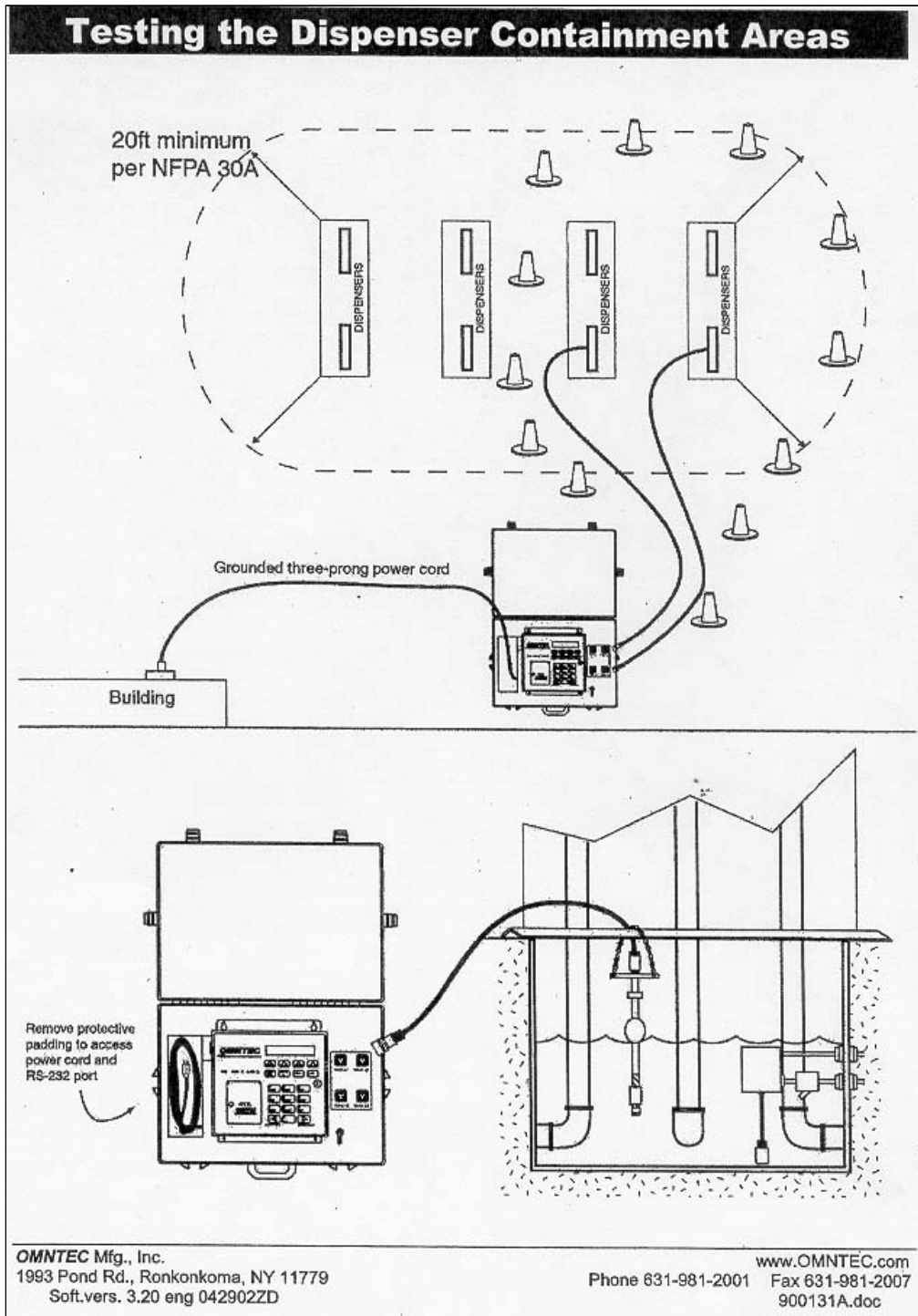

Fig. 5-2f: Dispenser Containment Area

Appendix A Probes

When printing manual, replace this page with Appendix A.

Appendix B Sensors

When printing manual, replace this page with Appendix B.

Appendix C Connector Sealing Kits

When printing manual, replace this page with Appendix C.

Appendix D OEL8000II Controller

When printing manual, replace this page with Appendix D.

Appendix E Remote Annunciator

When printing manual, replace this page with Appendix E.

Appendix F Interface Boards

When printing manual, replace this page with Appendix F.

Appendix G Modem

When printing manual, replace this page with Appendix G.

Appendix H NYC Fire Dept. Conditions of Approval

When printing manual, replace this page with Appendix H.