

Rosemount 3101, 3102, and 3105

Ultrasonic Liquid Level Transmitters



Rosemount 3101, 3102, and 3105 Ultrasonic Liquid Level Transmitters

⚠ WARNING

Read this manual before working with the product. For personal and system safety, and for optimum product performance, make sure you thoroughly understand the contents before installing, using, or maintaining this product.

Within the United States, Rosemount Inc. has two toll-free assistance numbers.

Customer Central: 1-800-999-9307(7:00 a.m. to 7:00 p.m. CST)
Technical support, quoting, and order-related questions.

North American Response Center:

Equipment service needs.

1-800-654-7768 (24 hours a day – Includes Canada)

For equipment service or support needs outside the United States, contact your local Rosemount representative.

⚠ CAUTION

The products described in this document are NOT designed for nuclear-qualified applications.

Using non-nuclear qualified products in applications that require nuclear-qualified hardware or products may cause inaccurate readings.

For information on Rosemount nuclear-qualified products, contact your local Rosemount Sales Representative.

This device complies with part 15 of the FCC rules. Operation is subject to the following two conditions: (1) This device may not cause harmful interference, and (2) this device must accept any interference received, including interference that may cause undesired operation.

Contents

Section 1: Introduction

1.1 Safety messages	1
1.2 Manual overview.....	1
1.3 Service support.....	2
1.4 Product recycling/disposal	2

Section 2: Transmitter Overview

2.1 The Rosemount 3101, 3102, and 3105	3
2.1.1 Theory of operation	4
2.2 Components of the transmitter.....	4
2.3 System architecture.....	6

Section 3: Installation

3.1 Safety messages	7
3.2 Considerations before installation	8
3.2.1 Safety considerations	8
3.2.2 Environmental considerations.....	9
3.3 Mechanical installation	10
3.3.1 Mounting considerations	10
3.3.2 Consider liquid surface conditions	10
3.3.3 Consider in-tank effects	11
3.3.4 Mounting the transmitter above the liquid surface.....	12
3.3.5 Open channel flow installations (the 3102/3105)	14
3.4 Electrical installation	16
3.4.1 Connecting the cable(s) to the transmitter.....	16
3.4.2 Connecting the cable wires to the Rosemount 3101	17
3.4.3 Connecting the cable wires to the Rosemount 3102	18
3.4.4 Connecting the cable wires to the Rosemount 3105	19
3.4.5 Remote temperature sensor	21
3.4.6 Wiring to allow HART communications.....	21
3.4.7 Lightning / surge protection and other loop devices.....	21

Section 4: Starting up

4.1	Safety messages	23
4.2	Programming the Rosemount 3101, 3102, and 3105 Transmitters	24
4.2.1	Integral display and buttons	24
4.2.2	What happens when powering up the transmitter	25
4.2.3	Considerations before starting the programming	25
4.3	Programming the 3101 using the integral display and buttons	26
4.3.1	Display units (on the 3101)	26
4.3.2	First measurements (on the 3101)	27
4.3.3	Setting the bottom reference (on the 3101)	28
4.3.4	Setting 4 mA and 20 mA levels (on the 3101)	28
4.3.5	Setting the output damping (on the 3101)	30
4.3.6	Selecting the Lost Echo action (on the 3101)	31
4.3.7	Setting 4 mA and 20 mA levels using ranging (on the 3101)	32
4.3.8	Learn about echoes from false targets (on the 3101)	33
4.3.9	Do final checks	34
4.3.10	What happens when a power failure occurs	34
4.4	Programming the 3102 and 3105 using the integral display and buttons	35
4.4.1	Overview of programming the 3102 or the 3105	35
4.4.2	Selecting the duty (on the 3102/3105)	35
4.4.3	Selecting the units of measurement (on the 3102/3105)	36
4.4.4	Setting the correct bottom reference (on the 3102/3105)	38
4.4.5	Selecting a profile (on the 3102/3105)	39
4.4.6	Power factor for the flow law (on the 3102/3105)	43
4.4.7	Setting the scaling factor (on the 3102/3105)	44
4.4.8	Maximum level entry (on the 3102/3105)	45
4.4.9	Maximum flow entry (on the 3102/3105)	46
4.4.10	Maximum contents (volume) entry (on the 3102/3105)	47
4.4.11	Setting the 4 mA point (on the 3102/3105)	48
4.4.12	Setting the 20 mA point (on the 3102/3105)	49
4.4.13	Setting the output damping (on the 3102/3105)	50
4.4.14	Selecting the Lost Echo action (on the 3102/3105)	51
4.4.15	Setting the relay on and off points (on the 3102)	52
4.4.16	Setting the 4 and 20 mA levels using ranging (on the 3102/3105)	54
4.4.17	Do final checks	55
4.4.18	What happens when a power failure occurs	55

Section 5: Service and Troubleshooting

5.1 Safety messages	57
5.2 Servicing	58
5.3 Diagnostics for the 3101	58
5.3.1 General troubleshooting	58
5.3.2 Error messages	58
5.4 Diagnostics for the 3102 and the 3105	59
5.4.1 General troubleshooting (on the 3102/3105)	59
5.4.2 Fault and alarms (on the 3102/3105)	59
5.4.3 Diagnostic data (on the 3102/3105)	60
5.4.4 Loop test (on the 3102/3105)	61
5.5 Engineering menu for the 3102 and 3105	62
5.5.1 Accessing the engineering menu (on the 3102/3105)	62
5.5.2 Setting the threshold (on the 3102/3105)	63
5.5.3 Setting lost echo time (on the 3102/3105)	64
5.5.4 Setting the dead band (on the 3102/3105)	65
5.5.5 Setting the frequency (on the 3102/3105)	66
5.5.6 Setting the pulse repetition frequency (on the 3102/3105)	67
5.5.7 Setting valid echo count (on the 3102/3105)	68
5.5.8 Setting spike rejection (on the 3102/3105)	69
5.5.9 Learn about echoes from false targets (on the 3102/3105)	69
5.5.10 Setting the ambient temperature (on the 3102/3105)	71
5.5.11 Temperature calibration (on the 3102/3105)	72
5.5.12 Loading factory default values (on the 3102/3105)	73
5.5.13 Changing the base units (on the 3102/3105)	74
5.6 False echoes under certain ambient operating conditions (on the 3102/3105)	75

Appendix A: Reference Data

A.1 Specifications	77
A.1.1 General	77
A.1.2 Measuring performance	77
A.1.3 Display and configuration	78
A.1.4 Electrical	79
A.1.5 Materials	80
A.1.6 Mechanical	80
A.1.7 Measuring	81
A.1.8 Environment	81

A.1.9	Temperature and pressure ratings	82
A.1.10	Load limitations	83
A.2	Dimension drawings	84
A.3	Ordering information	87
A.3.1	Rosemount 3101 ordering information.....	87
A.3.2	Rosemount 3102 ordering information.....	88
A.3.3	The Rosemount 3105 level transmitter	89
A.4	Spare parts and accessories	90
A.4.1	Spare parts and accessories for the 3101/3102/3105.....	90

Appendix B: Product Certifications

B.1	Manufacturing location	91
B.2	European Union directive information	91
B.3	Non-hazardous location certifications	92
B.3.1	American and Canadian certifications	92
B.4	Hazardous locations certifications	93
B.4.1	American and Canadian certifications	93
B.4.2	European certification.....	93
B.4.3	International certifications	94
B.5	Approval drawings	97

Appendix C: Integrated Display Menus

C.1	Menus on the 3101	102
C.2	Menus on the 3102 and the 3105	103

Appendix D: Rosemount 3490 Series Menus

D.1	Introduction	109
D.2	Menus and parameters	109

Appendix E: Field Communicator Menus

E.1	Introduction	113
E.2	Menus and parameters	113

Appendix F: Programming the 3102 and 3105 using HART

F.1	Overview of programming the 3102 and 3105	117
F.1.1	Using a Rosemount 3490 Series Control Unit.....	117
F.1.2	Using a Field Communicator or AMS Device Manager	117

F.2	Command parameters	118
F.2.1	Base units	118
F.2.2	Set as empty	120
F.2.3	Present depth	121
F.2.4	Learn false echo	122
F.2.5	Auto tank map	124
F.2.6	Simulation of PV	125
F.2.7	Restart device	126
F.2.8	Load defaults	127
F.2.9	Simulate current output	128
F.2.10	Trim 4 mA / trim 20 mA	129
F.3	Configuration parameters	131
F.3.1	Message (P000)	131
F.3.2	Tag (P001)	132
F.3.3	Descriptor (P002)	133
F.3.4	Final assembly number (P004)	134
F.3.5	Serial number (P005)	135
F.3.6	Bottom reference (P010)	136
F.3.7	Upper blanking (P023)	138
F.3.8	Lower blanking (P063)	140
F.3.9	Distance offset (P060)	141
F.3.10	Level offset (P069)	142
F.3.11	Tank shape / non-linear profile (P011)	143
F.3.12	Contents (volume) measurement	145
F.3.13	Flow measurement	150
F.3.14	Primary variable units (P012)	153
F.3.15	Scale factor / k-factor (P013)	154
F.3.16	Profile height / power factor (P014)	156
F.3.17	Profile points 1 to 10 (P030 to P039)	158
F.3.18	Upper range value (P015)	159
F.3.19	Lower range value (P016)	160
F.3.20	Damping (P020)	162
F.3.21	Relay 1 mode (P070) on the Rosemount 3102	163
F.3.22	RL1 PV <i>on</i> point (P071) on the Rosemount 3102	165
F.3.23	RL1 PV <i>off</i> point (P072) on the Rosemount 3102	166
F.3.24	Relay 2 mode (P073) on the Rosemount 3102	167
F.3.25	RL2 PV <i>on</i> point (P074) on the Rosemount 3102	168
F.3.26	RL2 PV <i>off</i> point (P075) on the Rosemount 3102	169

F.3.27	Lost echo delay (P021)	170
F.3.28	Lost echo action (P022).....	172
F.3.29	Speed of sound (P024)	174
F.3.30	Temperature (P025)	176
F.3.31	Set threshold (P026)	177
F.3.32	Transmit power control (P040)	178
F.3.33	Pulse repeat (P041)	179
F.3.34	Echoes needed (P042).....	180
F.3.35	Threshold 1 time (P043).....	181
F.3.36	Threshold 1 size (P048).....	182
F.3.37	Target pulses (P044)	183
F.3.38	Target frequency (P045).....	184
F.3.39	Spike rejection (P049)	185
F.3.40	False echo data (P081 to P088)	186
F.3.41	Clear false echoes (P089)	187
F.3.42	Transducer material (P970)	188
F.3.43	Poll address (D951)	189
F.3.44	Maximum temperature (P046)	190
F.3.45	Minimum temperature (P047)	191
F.3.46	Date (P003).....	192
F.4	Monitoring and diagnostic parameters	193
F.4.1	Process value / primary variable (PV) (D900)	193
F.4.2	Level / Secondary Variable (SV) (D901)	194
F.4.3	Distance / tertiary variable (TV) (D902).....	195
F.4.4	Temperature / fourth variable (FV) (D903)	196
F.4.5	% of current output (D905)	197
F.4.6	Current output (D906)	198
F.4.7	Distance (D910)	199
F.4.8	Echo size (D911).....	200
F.4.9	Echo success (D912)	201
F.4.10	Target echoes (D913)	202
F.4.11	Speed of sound (D914).....	203
F.4.12	Temperature for SoS calculation (D915).....	204
F.4.13	Frequency (D916)	205
F.4.14	Threshold in use (D917)	206
F.4.15	Pulses in use (D918).....	207
F.4.16	Transmit power (D919).....	208
F.4.17	Model code (D949)	209

F.4.18	Hardware rev. (D952)	210
F.4.19	Software revision (D953)	211
F.4.20	Manufacturer (D960).....	212
F.4.21	Unique device ID (D961).....	213
F.4.22	HART revision (D962)	214
F.4.23	Transmitter specific command revision (D963)	215
F.4.24	Preambles (D964)	216
F.4.25	Transmitter flags (D965).....	217
F.4.26	Primary variable trend	218
F.4.27	Temperature Trend	218
F.4.28	Distance and Echo Size Trend	219

Section 1 Introduction

1.1 Safety messages

Procedures and instructions in this section may require special precautions to ensure the safety of the personnel performing the operation. Information that raises potential safety issues is indicated by a warning symbol (⚠). Refer to the following safety messages before performing an operation preceded by this symbol.

⚠ WARNING

Failure to follow these installation guidelines could result in death or serious injury.

- Make sure only qualified personnel perform the installation.
- Use the equipment only as specified in this manual. Failure to do so may impair the protection provided by the equipment.

Explosions could result in death or serious injury.

- Verify that the operating environment of the transmitter is consistent with the appropriate hazardous locations certifications.
- Before connecting a HART®-based communicator in an explosive atmosphere, make sure the instruments in the loop are installed in accordance with intrinsically safe or non-incendive field wiring practices.

Electrical shock could cause death or serious injury.

- Use extreme caution when making contact with the leads and terminals.

⚠ WARNING

Any substitution of non-recognized parts may jeopardize safety. Repair, e.g. substitution of components etc., may also jeopardize safety and is under no circumstances allowed.

1.2 Manual overview

This manual provides installation, configuration and maintenance information for the Rosemount 3101, 3102, and 3105 Ultrasonic Liquid Level Transmitters.

[Section 2: Transmitter Overview](#)

[Section 3: Installation](#)

[Section 4: Starting up](#)

[Section 5: Service and Troubleshooting](#)

[Appendix A: Reference Data](#)

[Appendix B: Product Certifications](#)

Appendix C: Integrated Display Menus

Appendix D: Rosemount 3490 Series Menus

Appendix E: Field Communicator Menus

Appendix F: Programming the 3102 and 3105 using HART

1.3 Service support

To expedite the return process outside of the United States, contact the nearest Emerson Process Management representative.

Within the United States, call the Emerson Process Management Instrument and Valves Response Center using the 1 800 654 7768 toll-free number. This center, available 24 hours a day, will assist you with any needed information or materials.

The center will ask for product model and serial numbers, and will provide a Return Material Authorization (RMA) number. The center will also ask for the process material to which the product was last exposed.

▲ CAUTION

Individuals who handle products exposed to a hazardous substance can avoid injury if they are informed of, and understand, the hazard. If the product being returned was exposed to a hazardous substance as defined by OSHA, a copy of the required Material Safety Data Sheet (MSDS) for each hazardous substance identified must be included with the returned goods.

1.4 Product recycling/disposal

Recycling of equipment and packaging should be taken into consideration. The product and packaging should be disposed of in accordance with local and national legislation.

Section 2 Transmitter Overview

The Rosemount 3101, 3102, and 3105	page 3
Components of the transmitter	page 4
System architecture	page 6

2.1 The Rosemount 3101, 3102, and 3105

The 3101, 3102, and 3105 are 4–20 mA loop-powered level transmitters designed for continuous liquid level measurements in tanks or open channel flows.

The transmitters can be connected directly to a plant control system, or used with a Rosemount 3490 Series Control Unit for programmable control functionality. The Rosemount 3105 may be mounted in a hazardous area if powered from a protected power supply.

Figure 2-1. Typical Application using a Rosemount 3100 Series Transmitter

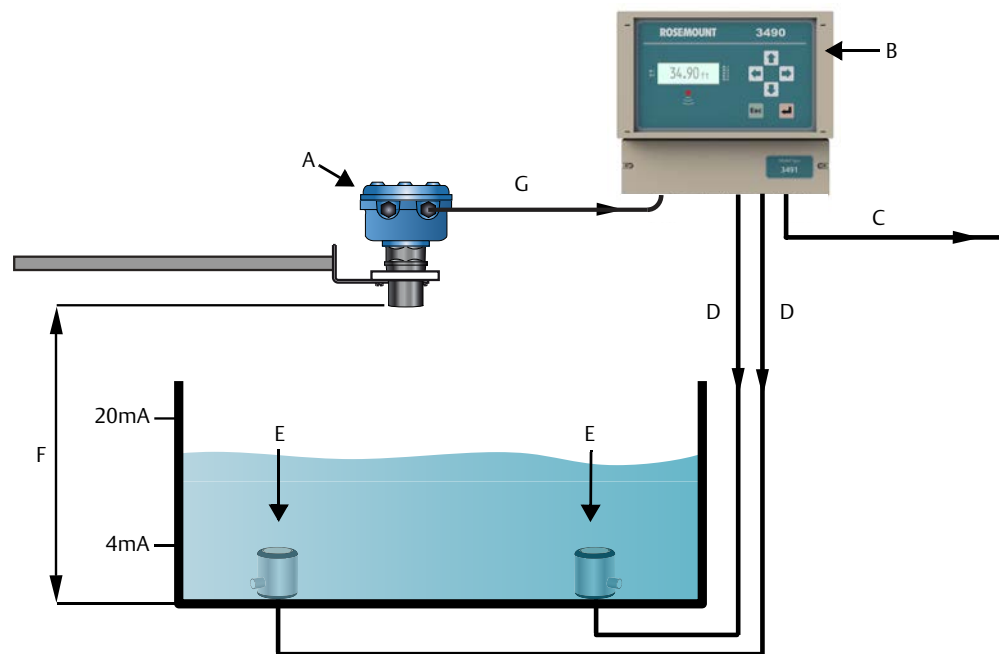

- | | |
|---------------------------------------|---------------------------------|
| A. Rosemount 3100 Series Transmitter | E. Pump |
| B. Rosemount 3490 Series Control Unit | F. Transmitter Bottom Reference |
| C. 4–20 mA Signal | G. 4–20 mA and HART Signal |
| D. Relay | |

Note
HART is available on the Rosemount 3102 and Rosemount 3105.

2.1.1 Theory of operation

The Rosemount 3101, 3102, and 3105 transmitters are designed to be mounted above a liquid and use ultrasonic pulses to continuously measure the distance to the liquid surface. The microprocessor-controlled electronics calculate the distance to the liquid level from the time delay between the transmitting and receiving of the signals.

When programmed with the bottom reference of the application, usually the tank bottom ([Figure 2.2](#)), the transmitter calculates the liquid depth (level) and outputs the level as a 4–20 mA signal (and a digital HART® signal on the 3102 and 3105).

The 3101 calculates the level only and then outputs the result as a 4–20 mA signal.

The 3102 and 3105 can calculate level, contents (volume), or open channel flow, and then output the result as a 4–20 mA signal and a digital HART signal.

A LCD screen inside the enclosure displays the selected measurement. Programming is achieved using integral buttons inside the enclosure (all models), or by remote communication using HART (on the 3102 and the 3105 only).

2.2 Components of the transmitter

The Rosemount 3101, 3102, and 3105 transmitters have a housing containing advanced electronics for signal processing, and terminals for connecting the external power supply. The electronics produces an ultrasonic signal from the transmitter face.

A comprehensive specification for the Rosemount 3101, 3102, and 3105 is in the section [“Specifications” on page 77](#).

Figure 2-2. The 3101, 3102, and 3105 Components

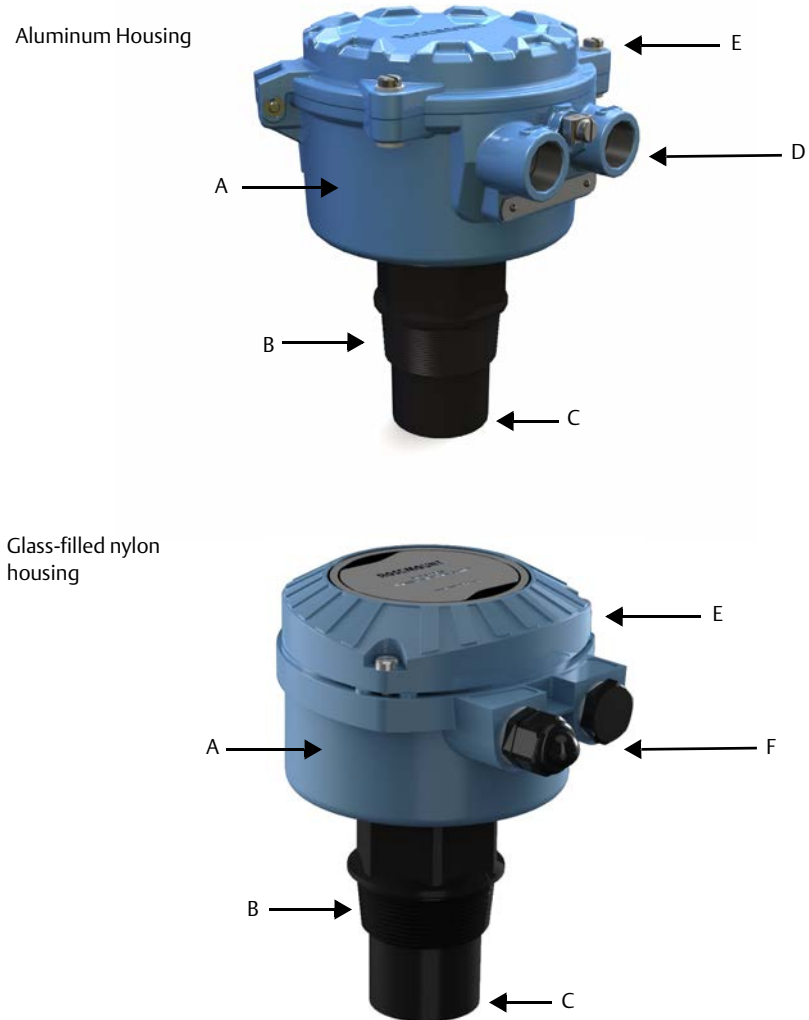

- A. Electronics Housing
- B. 2-in. Mounting Thread
- C. Transmitter Face
- D. $\frac{1}{2}$ -14 NPT Conduit Threads ($\frac{1}{2}$ -14 NPT to M20 x 1.5 adaptors are available when ordering. See [page 90](#))
- E. Housing Cover (*opened by un-doing three screws*)
- F. M20 x 1.5 Conduit Threads (supplied with one IP66/67 nylon compression cable gland and one M20 plug)

2.3 System architecture

The Rosemount 3101, 3102, and 3105 are two-wire 24 Vdc loop-powered transmitters and can be connected to a direct current (dc) power source using two-core, shielded cable.

On The Rosemount 3101, the output is a 4–20 mA analog signal.

On The Rosemount 3102 and Rosemount 3105, the output can be a 4–20 mA analog signal and a digital HART signal.

Note

It is possible to use the multi-drop function with the HART protocol (Figure 2-3). In this case, communication is restricted to digital since the current is fixed to 4 mA

Each transmitter can be configured locally using the push-buttons (3101) or membrane-buttons (3102/3105) which are revealed after removing the housing cover.

The 3102 and 3105 transmitters can be easily configured remotely by using a Rosemount 3490 Series Control Unit. Alternatively, a Field Communicator, or a PC with AMS Suite: Intelligent Device Manager software can be used to configure each transmitter.

A comprehensive specification for the Rosemount 3101, 3102, and 3105 is in the section “Specifications” on page 77.

Figure 2-3. System Architecture

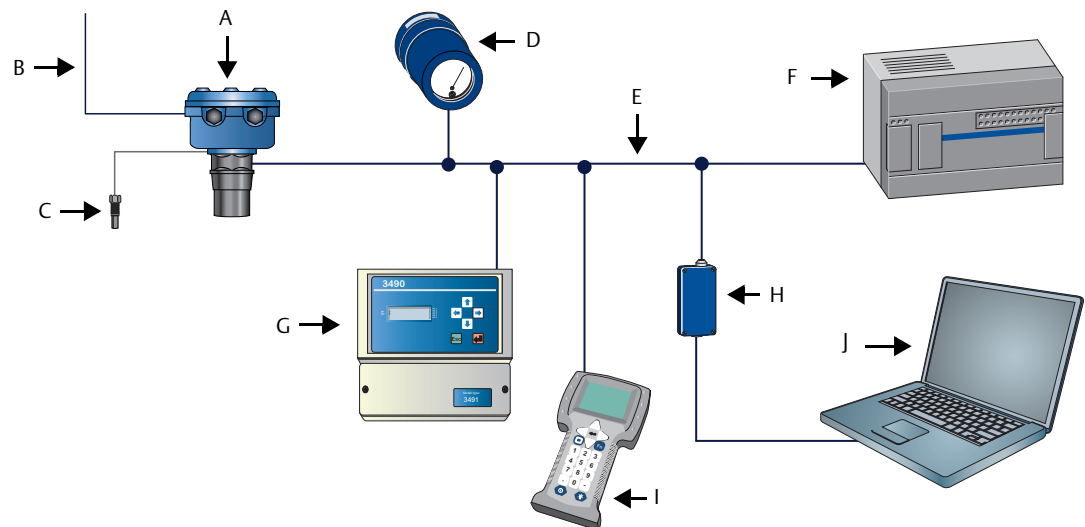

- A. Rosemount 3102 or 3105 Transmitter
- B. Two Relay Outputs from Transmitter (Rosemount 3102 only)
- C. Remote Temperature Sensor (Optional Accessory for Rosemount 3102 and Rosemount 3105 Transmitters)
- D. 751 Display
- E. 4–20 mA signal / HART communications
- F. Control System
- G. Rosemount 3490 Series Control Unit
- H. HART Modem
- I. Field Communicator
- J. AMS Suite: Intelligent Device Manager

Section 3 Installation

Safety messages	page 7
Considerations before installation	page 8
Mechanical installation	page 10
Electrical installation	page 16

3.1 Safety messages

Procedures and instructions in this section may require special precautions to ensure the safety of the personnel performing the operation. Information that raises potential safety issues is indicated by a warning symbol (⚠). Refer to the following safety messages before performing an operation preceded by this symbol.

WARNING

Explosions could result in death or serious injury.

- Verify that the operating environment of the transmitter is consistent with the appropriate hazardous locations certifications.
- Before connecting a HART[®]-based communicator in an explosive atmosphere, make sure the instruments in the loop are installed in accordance with intrinsically safe or non-incendive field wiring practices.
- Do not remove the housing cover in explosive atmospheres when the circuit is alive.

Failure to follow safe installation and servicing guidelines could result in death or serious injury.

- Make sure only qualified personnel perform the installation.
- Use the equipment only as specified in this manual. Failure to do so may impair the protection provided by the equipment.
- Do not perform any service other than those contained in this manual unless you are qualified.

Process leaks could result in death or serious injury.

- Make sure that the transmitter is handled carefully.

High voltage that may be present on leads could cause electrical shock.

- Avoid contact with leads and terminals
 - Make sure the main power to the transmitter is off and the lines to any other external power source are disconnected or not powered while wiring.
-

3.2 Considerations before installation

The Rosemount 3100 Series may be used for level and volume measurement in open- or closed-tanks, or open channel flow measurement.

The glass-filled nylon housing version of the transmitter must be installed in a location where it is protected from ultraviolet radiation to prevent long term degradation of the plastics used e.g. shrouded from direct sunlight.

It is important to correctly position the transmitter for reliable ultrasonic level measurement. For maximum accuracy and stability of the level measurement reading, the transmitter should be shrouded from direct sunlight and radiated heat.

The transmitter may be site-tuned to deal with most application conditions, but it is recommended that the following guidelines be adopted where relevant.

Note

The Rosemount 3100 Series is designed to be mounted in a *non-metallic fitting or flange*.

The use of metallic fittings/flanges is not recommended.

Please see [“Spare parts and accessories for the 3101/3102/3105” on page 90](#).

3.2.1 Safety considerations

- Installation must be carried out by suitably trained personnel in accordance with the applicable code of practice.
- If the equipment is likely to come into contact with aggressive substances, it is the responsibility of the user to take suitable precautions that prevent it from being adversely affected, thus ensuring that the type of protection is not compromised.

Aggressive substances are acidic liquids or gases that may attack metals or solvents that may affect polymeric materials.

Suitable precautions are regular checks as part of routine inspections, or establishing, from the material's datasheet, that it is resistant to specific chemicals.
- The equipment must only be cleaned with a damp cloth; do not use solvents.
- The equipment is not intended to be repaired by the user and is to be replaced by an equivalent certified unit. Repairs should only be carried out by the manufacturer or approved repairer.
- The transmitter is *Double Insulated*, and therefore Protective Earthing is not required. However, the cable shield/screen should be connected to a suitable ground (earth) at one end only (see [“Connecting the cable\(s\) to the transmitter” on page 16](#)).
- Note that if the equipment is used in a manner not specified by the manufacturer, the protection afforded by the equipment may be impaired.
- To ensure electro-magnetic compatibility in any European member state, it should not be installed in a residential area.

Note

It is not advisable to mount the transmitter in close proximity to a source of electrical noise such as a variable-speed drive or other high-powered electrical device.

3.2.2 Environmental considerations

- The Rosemount 3105 Transmitter is Intrinsically Safe (IS) approved for hazardous area installations.
- The Rosemount 3101, 3102, and 3105 Transmitters are designed for open- or closed-tank installation. They are weatherproof and protected against the ingress of dust.
- Avoid installing the transmitters near heat sources.

Figure 3-1. Environmental Considerations

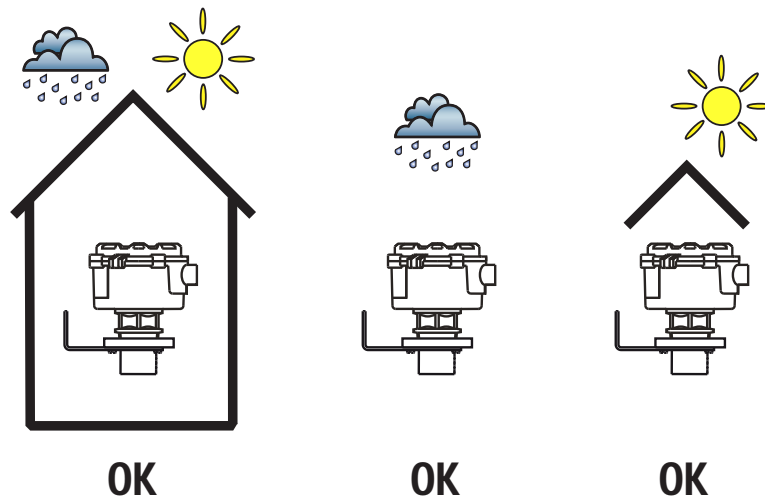

3.3 Mechanical installation

3.3.1 Mounting considerations

- Mount the transmitter above the liquid using the 2-in. thread provided, but no closer than 12 in. (0,3 m) to the surface. The transmitter does not detect any liquid surface closer than 12 in. (0,3 m) to the transmitter face. (See [“Mounting the transmitter above the liquid surface”](#) on page 12).
Optional flanges and bracket kits are available to help mounting (see [“Spare parts and accessories for the 3101/3102/3105”](#) on page 90).
- The transmitter should be mounted vertically to ensure a good echo from the liquid surface. The transmitter beam half angle is 6 degrees (see [Figure 3-2](#) on page 11).
- Obstructions in the tank, or well, may generate echoes which can be confused with the real liquid surface echo. Obstructions within the beam angle generate strong false echoes. Wherever possible, the transmitter should be positioned to avoid false echoes.
- To avoid detecting unwanted objects in the tank or well, it is advisable to maintain a distance sideways of at least 1.3 in. from the center line of the transmitter for every foot (11 cm per meter) range to the obstruction (see [Figure 3-2](#) on page 11).
- No false echoes are generated if the transmitter is located near the side of the tank or well, and the wall is smooth and free of protrusions. However, there will still be a reduction in the echo size. It is recommended that the transmitter be mounted no closer than 12 in. (0,3 m) to the wall to avoid a large reduction in the echo size.
- If the transmitter is mounted in an enclosed tank with a domed top, avoid mounting the transmitter in the center of the tank roof because this could act as a parabolic reflector and create unwanted echoes.
- Avoid applications where heavy condensation could form on the transmitter face.
- If the transmitter is mounted in a stand-off or nozzle, the transmitter face should protrude at least 0.2 in. (5 mm) into the tank. If this is not possible, see [“Mounting the transmitter above the liquid surface”](#) on page 12).
- If the transmitter is used in environments where direct sunlight can cause high temperatures on exposed surfaces, a sun-shade is recommended.
- Check that the *maximum liquid level* will not enter the 12-in. (0,3 m) blanking zone of the transmitter.

3.3.2 Consider liquid surface conditions

- Foaming liquids can reduce the size of the returned echo because foam is a poor ultrasonic reflector.

Mount an ultrasonic transmitter over an area of clear liquid, such as near the inlet to a tank or well. In extreme conditions, or where this is not possible, the transmitter may be mounted in a vented stilling tube provided that the inside measurement of the stilling tube is at least 4 in. (100 mm) and is smooth and free from joints or protrusions. It is important that the bottom of the stilling tube stays covered to prevent the ingress of foam.

- Avoid mounting the transmitter directly over any inlet stream.
- Liquid surface turbulence is not normally a problem unless it is excessive. The effects of turbulence are minor, but excessive turbulence can be dealt with by fine-tuning the transmitter on site, if necessary.

3.3.3 Consider in-tank effects

- Stirrers or agitators can cause a vortex. Mount the transmitter off-center of any vortex to maximize the return echo.
- If stirrer blades become uncovered, they create echoes as they pass through the ultrasonic beam. The transmitter can learn to ignore these false echoes (see [page 69](#) or [page 122](#)).
- In tanks with rounded or conical bottoms, mount the transmitter off-center. If needed, a perforated reflector plate can be installed on the tank bottom directly under the transmitter center line to ensure a satisfactory return echo.
- Avoid detecting pump casings, as the liquid falls away, by not mounting the transmitter directly above pumps. If this is not possible, fine-tuning of the transmitter on-site may be required.

Figure 3-2. Tank Installation Considerations

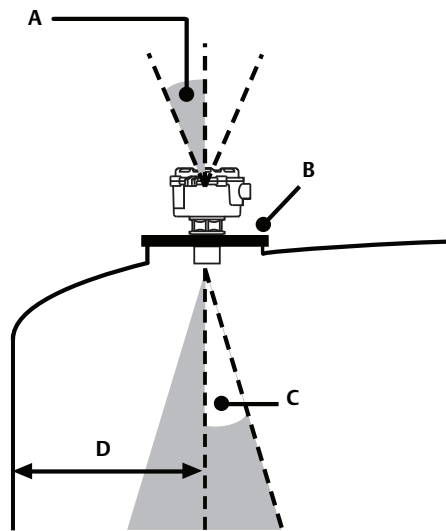

- A. Transmitter is Mounted Vertically (Maximum Deviation of 3°)
- B. Use Non-metallic Fitting or Flange
- C. 6° Beam Half Angle
- D. 1.3 in./ft. (11 cm/m). Minimum of 12 in. (0,3 m)

3.3.4 Mounting the transmitter above the liquid surface

A 2-in. thread is provided to mount the transmitter. The thread form is either **2-in. BSPT** or **NPT**, and is clearly marked on the hexagon of the transmitter body.

To help installation, flange accessories and bracket kits are available from Emerson Process Management. The accessory flanges supplied are manufactured from PVC and are a full face design. Care must be taken when installing to raised face mating flanges on the tank or vessel to prevent distortion of the PVC flange by over-tightening the bolts. See “[Spare parts and accessories for the 3101/3102/3105](#)” on page 90 for ordering information.

Note

The Rosemount 3101, 3102, and 3105 Transmitters are designed to be mounted in a *non-metallic fitting or flange*. **The use of metallic fittings/flanges is not recommended**

Bracket mounting

The bracket kit contains a stainless steel angle bracket and PVC threaded disc, which may be used to mount the transmitter on a support over the liquid surface.

The bracket and disc dimensions are in [Figure A-5 on page 86](#). The combined weight of bracket and disc is 16 oz (0,5 kg). For transmitter weight, see “[Specifications](#)” on page 77.

Installation instructions

1. Attach bracket to the disc using the three screws provided.
2. Attach the assembled bracket and disc to a rigid support over the liquid surface.
The bracket may be bolted to a suitable crossmember (structural section of steel). Ensure the transmitter is perpendicular to the surface to maximize the return echo size.
3. Use PTFE tape on the screw thread of the transmitter ([Figure 3-4 on page 13](#)).
4. Insert the transmitter into the disc.
5. Tighten to a torque of 1.5 ft-lb (2 N-m) using the transmitter’s hexagon.
Do not use the transmitter housing to tighten.

Figure 3-3. Bracket Kit Mounting

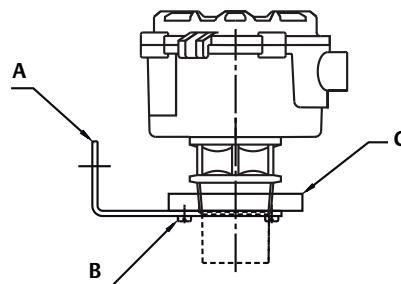

- A. Stainless Steel Bracket
 - B. No. 4X 13 Long Self Tap Screw (3 Positions) Carbon Steel (Zinc Plated)
 - C. PVC Disc
-

Installing in a tank with a nozzle or stand-off

Installation instructions

1. Use PTFE tape on the screw thread of the transmitter (Figure 3-4 on page 13).
2. If the tank has a flanged nozzle or stand-off:
 - a. Attach the transmitter to a non-metal instrument flange using the threaded connection. Tighten to a torque of 1.5 lb-ft (2 N-m) using the transmitter’s hexagon.
 - b. The instrument (accessory) flanges supplied by Emerson Process Management are manufactured from PVC and are a full face design. Care must be taken when installing to a raised face mating flange on the tank or vessel to prevent distortion of the PVC flange by over-tightening the bolts.
 - c. Ensure the gasket is sitting correctly on the nozzle/tank flange.
 - d. Lower the assembled transmitter and instrument flange onto the tank flange, and secure with appropriate bolting to a suitable torque for the flanges.

If mating to a raised face flange (RF) on the tank nozzle or stand-off, tighten to a maximum torque of 10 lb-ft (13.6 N-m).
3. If the tank has a threaded nozzle or stand-off:
 - a. Attach the transmitter to the nozzle/stand-off using the threaded connection.
 - b. Tighten to a torque of 1.5 lb-ft (2 N-m) using the transmitter’s hexagon.

Note

If the transmitter face does not protrude into the vessel, note the dimensions in Table 3-1 for Figure 3-4, and always ensure that the nozzle/vessel weld is smooth and free from internal weld beads or other projections.

Figure 3-4. Mounting the Transmitter using a Nozzle/Stand-off

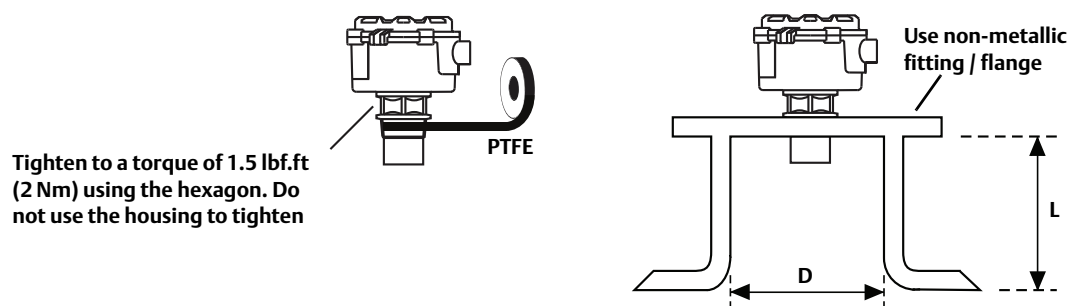

Table 3-1. Nozzle diameter size (D) and maximum length (L)

Nozzle Diameter Size (D)	Maximum Nozzle Length (L)
DN50 (2 in.)	4 in. (100 mm)
DN80 (3 in.)	6.3 in. (160 mm)
DN100 (4 in.)	6.3 in. (160 mm)
≥DN125 (5 in.)	11.8 in. (300 mm)

3.3.5 Open channel flow installations (the 3102/3105)

There are normally two distinct parts to an open channel flow measurement system; the **primary element** (flow structure) and the **secondary element** (Head measurement instrumentation). For accurate open channel flow measurement, both parts of the system must be correctly installed. This section explains the important parts of installing the transmitter (secondary element). The flow structure (primary element) installation can be referenced in the British (BS3680) or ISO International standards.

Positioning of the transmitter is critical, and should be the correct distance upstream from the flow structure as stated in the relevant standard for your country. For example, in the ISO standards, the distance should be four to five times the maximum height of the water (H_{max}) for a thin plate weir, or three to four times H_{max} for a flume. For optimum accuracy, position the transmitter's front face at a height equal to the sum of the maximum flow depth plus the transmitter deadband of 12.2 in. (300 mm) plus an extra 2 in. (50 mm).

Figure 3-5. Choosing the Height Position above a Flow

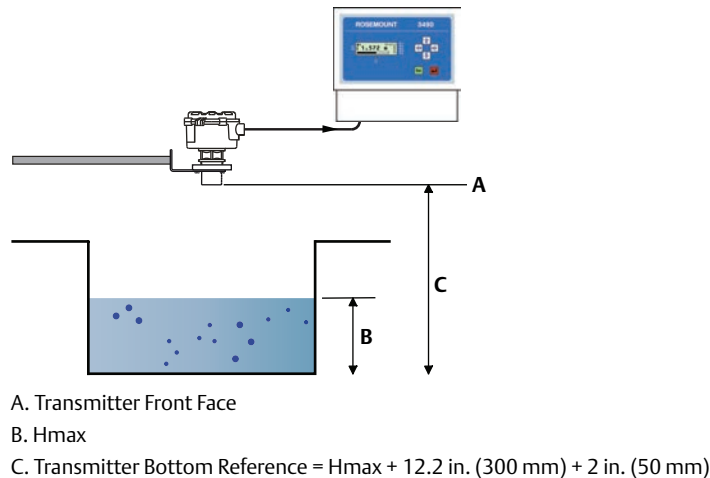

It is important that the **bottom reference** of the transmitter should be related to the datum of the primary measuring device (see Figure 3-6).

Figure 3-6. Transmitter Bottom Reference for a Flume or Weir

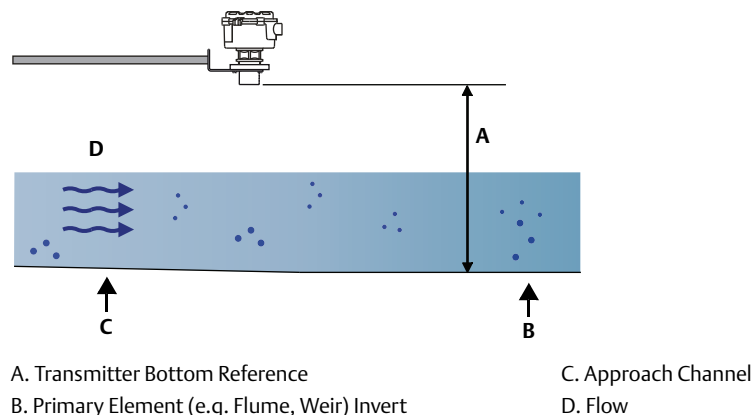

When setting the bottom reference on a 'V' notch weir, it is important the true invert is used and not the meniscus level (Figure 3-7).

Figure 3-7. Bottom reference of a 'V'-notch weir

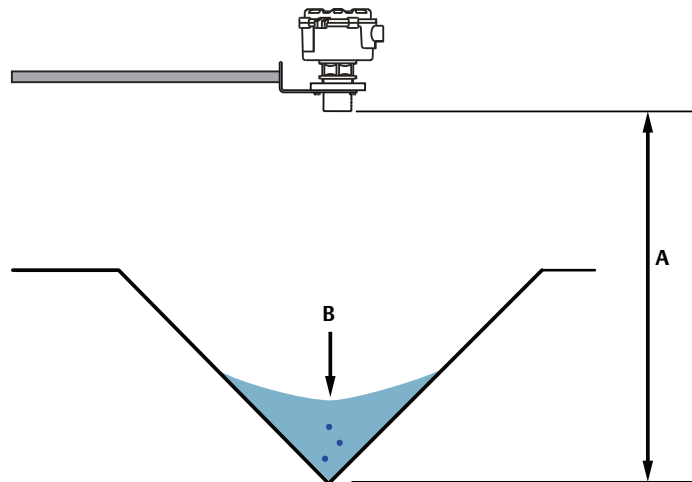

- A. Transmitter Bottom Reference (i.e. True Invert)
- B. Meniscus Level

Note

The transmitter should be free from a situation where it is likely to 'drown' (refer to relevant Standard for further information)

The Rosemount 3102 and Rosemount 3105 have the option of a Remote Temperature Sensor (RTS) for temperature compensation (see page 21). The temperature sensor should be mounted in a location where it can get an accurate air temperature measurement and is protected from sunlight. (See Quick Installation Guide 00825-0100-4842 for further RTS installation information)

If the flow structure permits, mount the transmitter within the flow channel or chamber. Shroud the transmitter from direct sunlight for maximum accuracy and stability

3.4 Electrical installation

3.4.1 Connecting the cable(s) to the transmitter

The Rosemount 3100 Series is a two-wire loop-powered transmitter accepting power supplies as follows:

- The 3101: 12 to 30 Vdc
- The 3102: 12 to 40 Vdc
- The 3105: 12 to 40 Vdc (non-hazardous), 12 to 30 Vdc (hazardous).

Note

To comply with the CSA approval requirements, the 3101 and the 3102 must be powered from a Rosemount 3490 Series Control Unit or a class 2 separate extra-low voltage (SELV) source

Other devices may reset if connecting the transmitter to a multi-drop system while the loop is powered. De-energize the loop to avoid devices being reset

Each transmitter is supplied with two cable entries. A suitable conduit system or cable gland must be used to maintain the weather-proof rating and hazardous area protection. Any unused entry must be sealed with a suitably rated blanking plug.

A two-core, shielded/screened cable is required for external power supply and output signal connections. The cable is not supplied.

Connect the cable(s) to the transmitter

1. Make sure that the power supply is disconnected.
2. Undo the three cover screws and then lift the transmitter housing cover.
The cover on the metal housing can rest on the hinge. Place an object under the cover to avoid the transmitter toppling over.
3. Pass the cable through the cable gland/conduit.
4. Connect the cable wires:
 - a. For The Rosemount 3101, connect wires according to the section [“Connecting the cable wires to the Rosemount 3101” on page 17](#).
 - b. For The Rosemount 3102, connect wires according to the section [“Connecting the cable wires to the Rosemount 3102” on page 18](#).
 - c. For The Rosemount 3105, connect wires according to the section [“Connecting the cable wires to the Rosemount 3105” on page 19](#).
5. Connect the cable shield/screen to a suitable ground (earth) at one end only.
6. Replace the cover, tighten the cable gland, and connect the power supply.

What to do after completing the cabling

To maintain the weather-proof rating and hazardous area protection of the transmitter, ensure all cable glands, blanking plugs, and seals are in good condition.

Check that the cover seal is in good condition, and not twisted or misaligned in the seal location groove. When replacing the cover, tighten the three cover screws evenly to exert uniform pressure on the cover seal.

3.4.2 Connecting the cable wires to the Rosemount 3101

The Rosemount 3101 is not intrinsically safe, and is for use in non-hazardous (ordinary location) installations only.

Wire the transmitter as shown in Figure 3-8.

Important

- Make sure that the power supply is off when connecting the transmitter

Table 3-2. Terminal Connections on the Rosemount 3101

Connections	
Terminal 1	24 Vdc
Terminal 2	0 Vdc
Earth Screen	Connect the cable shield/screen to ground (earth) in the control room

Figure 3-8. Wiring Diagram for the Rosemount 3101

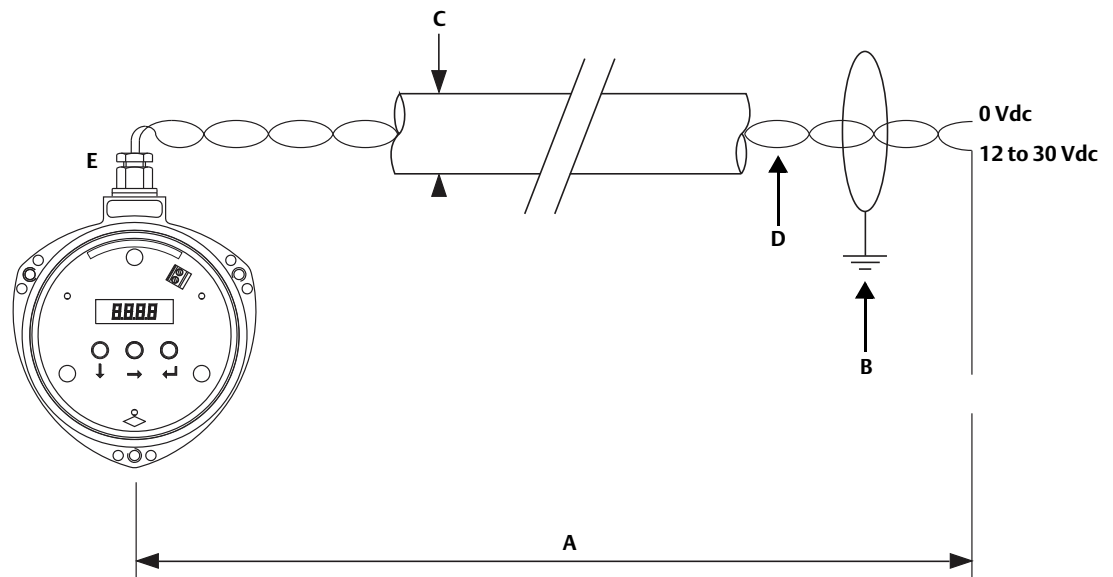

- A. Maximum cable length is 9750 ft. (3000 m)
- B. Connect the cable shield/screen to ground (earth) in the control room
- C. Cable thickness: \varnothing 0.15 to 0.31 in. (\varnothing 4 to 8 mm)
- D. Twisted-pair, screened wires. Minimum size: 0.22 mm² (24 SWG / 23 AWG); Maximum: 1.5 mm² (16 SWG / 18 AWG)
- E. Minimum of 12 Vdc is required at the transmitter for it to operate

3.4.3 Connecting the cable wires to the Rosemount 3102

The Rosemount 3102 is not intrinsically safe, and is for use in non-hazardous (Ordinary Location) installations only.

Wire the transmitter as shown in Figure 3-9. If HART digital communications is required, see also “Wiring to allow HART communications” on page 21.

Important

Make sure the power supply is off when connecting the transmitter

Table 3-3. Terminal Connections on the Rosemount 3102

Connections	
Terminal 1	24 Vdc
Terminal 2	0 Vdc
Terminal 3	RL1 (SPST) - see “Relays” on page 19
Terminal 4	RL1 (SPST) - see “Relays” on page 19
Terminal 5	RL2 (SPST) - see “Relays” on page 19
Terminal 6	RL2 (SPST) - see “Relays” on page 19
Terminal 7	Remote temperature sensor (if used) - see “Remote temperature sensor” on page 21
Terminal 8	Remote temperature sensor (if used) - see “Remote temperature sensor” on page 21
Earth Screen	Connect the cable shield/screen to ground (earth) in the control room

Figure 3-9. Wiring Diagram for the Rosemount 3102

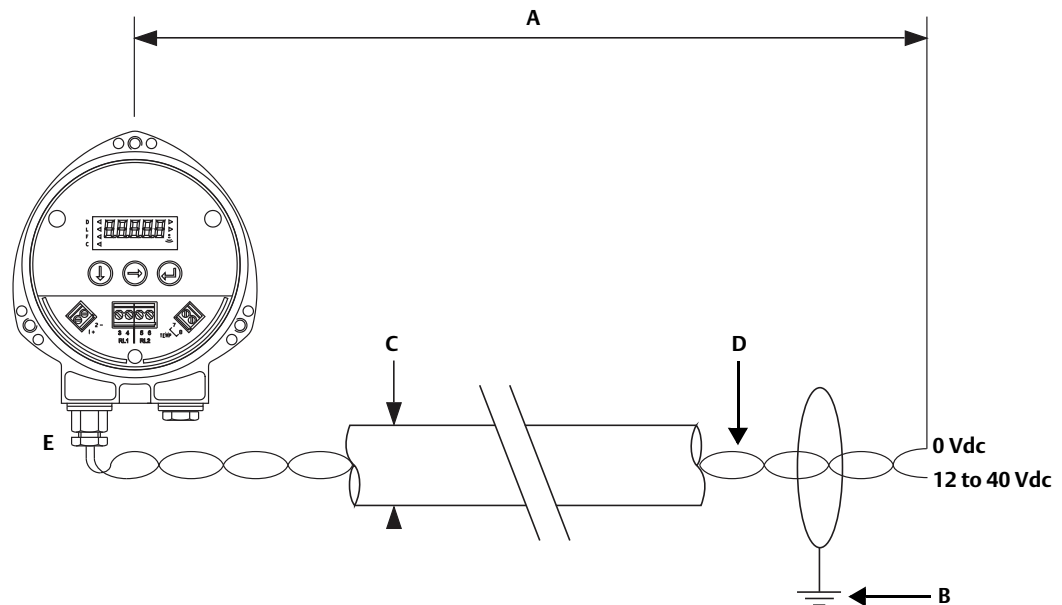

- A. Maximum cable length is 9750 ft. (3000 m)
- B. Connect the cable shield/screen to ground (earth) in the control room
- C. Cable thickness: Ø0.15 to 0.31 in. (Ø4 to 8 mm)
- D. Twisted-pair, screened wires. Minimum size: 0.22 mm² (24 SWG / 23 AWG); Maximum: 1.5 mm² (16 SWG / 18 AWG)
- E. Minimum of 12 Vdc is required at the transmitter for it to operate

Relays

The 3102 has two integral relays which may be used for fault indication or control purposes. These relays are for *light duty* and should be used as signal relays only, with control functions being performed by external control relays.

Relay number 2 is defaulted as a 'fault' relay - normally energized - but may be re-configured on-site as a set-point relay if required.

Relay status indicators are on the LCD inside the housing (see “Integral display and buttons” on page 24).

3.4.4 Connecting the cable wires to the Rosemount 3105

The Rosemount 3105 is for intrinsically safe installations. See [Appendix B: Product Certifications](#) for the safety approvals and control drawings.

Important

- Make sure the power supply is off when connecting the transmitter
-

Installation in a non-hazardous (ordinary location) area

Wire the transmitter as shown in [Figure 3-10 on page 20](#).

Installation in a hazardous area

When the 3105 is powered by a Rosemount 3490 Series Control Unit, *no safety barriers are required* as the output from the control unit is Intrinsically Safe.

If powering the transmitter from any other power supply, ensure a suitable Intrinsically Safe barrier is fitted in the non-hazardous (safe) area.

The barrier must be chosen such that its output parameters U_o , I_o and P_o are less than U_i , I_i and P_i of the transmitter (see [Appendix B: Product Certifications](#)).

The sum of the capacitance and the inductance of the transmitter and the connecting cable fitted must not exceed the maximum specified for the barrier chosen.

Note

Make sure that the instruments in the loop are installed according to intrinsically-safe field wiring practices and control drawings, when applicable

If HART digital communications is required, see also “[Wiring to allow HART communications](#)” on page 21.

Table 3-4. Terminal Connections on the Rosemount 3105

Connections	
Terminal 1	24 Vdc
Terminal 2	0 Vdc
Terminal 7	Remote temperature sensor (if used) - see "Remote temperature sensor" on page 21
Terminal 8	Remote temperature sensor (if used) - see "Remote temperature sensor" on page 21
Earth Screen	Connect the cable shield/screen to ground (earth) in the control room

Figure 3-10. Wiring Diagram for the Rosemount 3105

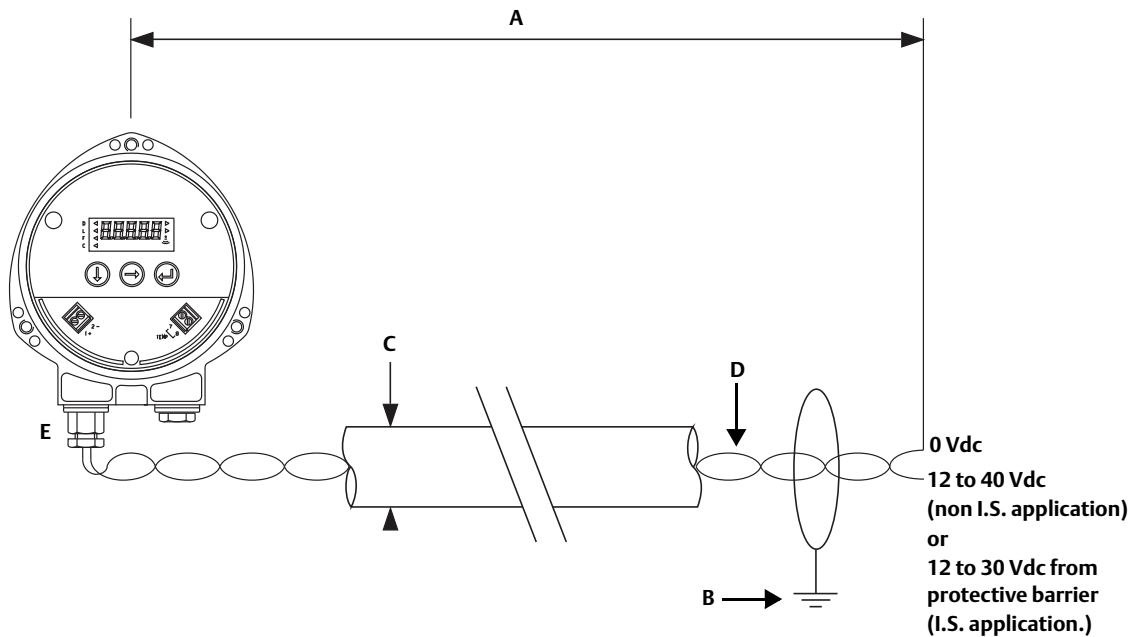

- A. Maximum cable length is 9750 ft. (3000 m)
- B. Connect the cable shield/screen to ground (earth) in the control room
- C. Cable thickness: \varnothing 0.15 to 0.31 in. (\varnothing 4 to 8 mm)
- D. Twisted-pair, screened wires. Minimum size: 0.22 mm² (24 SWG / 23 AWG); Maximum: 1.5 mm² (16 SWG / 18 AWG)
- E. Minimum of 12 Vdc is required at the transmitter for it to operate

3.4.5 Remote temperature sensor

The Rosemount 3102 and Rosemount 3105 accept input from a Rosemount Remote Temperature Sensor (see “[Spare parts and accessories for the 3101/3102/3105](#)” on page 90).

This is a thermistor-based temperature sensor designed for use with the 3102 and 3105.

Full installation instructions are supplied with the temperature sensor, but it should be mounted out of direct sunlight in a position so that it can give a representative reading of the air temperature between the liquid surface and the transmitter.

Note

Do not connect any other temperature sensor to the Rosemount 3102 or 3105 Transmitters.

3.4.6 Wiring to allow HART communications

If HART communications is required (*available on the 3102 and 3105 only*), a 250 Ohm (minimum), 0.25 W load resistor must be installed in the loop.

Note

When the transmitter is used with a Rosemount 3490 Series Control Unit, there is no need to install an external load resistor in the loop because a suitable resistor is built in to the control unit (see “[Load limitations](#)” on page 83).

If the transmitter is being supplied through a safety barrier, ensure the type chosen will pass HART information.

After the load resistor is installed, a Field Communicator can be connected across the load resistor. **It is the responsibility of the installer to ensure that any Field Communicator used in the hazardous area is suitably certified.**

Note

Make sure that the instruments in the loop are installed according to intrinsically-safe field wiring practices and control drawings, when applicable.

3.4.7 Lightning / surge protection and other loop devices

If the area is prone to lightning strikes or voltage surges, a suppressor device may be installed between the transmitter and the control unit.

If an additional loop-powered device or separately powered device is included in the two-wire loop, ensure the transmitter receives a minimum voltage of 12 Vdc. (See “[Load limitations](#)” on page 83).

Section 4 Starting up

Safety messages	page 23
Programming the Rosemount 3101, 3102, and 3105 Transmitters	page 24
Programming the 3101 using the integral display and buttons	page 26
Programming the 3102 and 3105 using the integral display and buttons	page 35

4.1 Safety messages

Procedures and instructions in this section may require special precautions to ensure the safety of the personnel performing the operation. Information that raises potential safety issues is indicated by a warning symbol (). Refer to the following safety messages before performing an operation preceded by this symbol.

WARNING

Explosions could result in death or serious injury.

- Verify that the operating environment of the gauge is consistent with the appropriate hazardous locations certifications.
- Before connecting a HART[®]-based communicator in an explosive atmosphere, make sure the instruments in the loop are installed in accordance with intrinsically safe or non-incendive field wiring practices.
- Do not remove the gauge cover in explosive atmospheres when the circuit is alive.

Failure to follow safe installation and servicing guidelines could result in death or serious injury.

- Make sure only qualified personnel perform the installation.
 - Use the equipment only as specified in this manual. Failure to do so may impair the protection provided by the equipment.
 - Do not perform any service other than those contained in this manual unless you are qualified.
-

4.2 Programming the Rosemount 3101, 3102, and 3105 Transmitters

Rosemount 3101, 3102, and 3105 Transmitters are operated from a menu of parameters, each held in a specific memory location within the transmitter. The memory locations may be pictured as a matrix, and are navigated for programming the instrument using → and ↓ steps.

Each transmitter is pre-programmed at the factory with a value in each parameter location so that when the power is first applied, the transmitter gives a sensible reading.

This section details the programming using the buttons provided inside the transmitter. The Integral Display menu structure is shown in [Appendix C: Integrated Display Menus](#).

Note

The 3102 and 3105 are HART-enabled, allowing remote communications with the instrument. For remote programming information, refer to [Appendix F: Programming the 3102 and 3105 using HART](#)

4.2.1 Integral display and buttons

The integral display allows up to five characters. In the normal running mode, the display shows a measurement termed the Process Value (PV) of the transmitter. In programming mode, on the display is data to assist with programming.

To the left of the main display are four arrow icons (3102/3105 only); one of which will be illuminated to indicate the duty chosen by the user: Distance-to-surface (D), Level (L), Flow (F), or Contents (C).

To the right of the PV display on the Rosemount 3102 are two arrow icons that indicate the status of the transmitter relays. When illuminated, they indicate the relay contact is closed.

Under the PV display is a text string indicating the units of measurement. The transmitter will illuminate only those characters applicable to the units of measurement chosen.

To the right of the text string is an echo received icon. It is made up of three arc segments that continuously indicate the strength of the echo received (minimum, average, and good).

Figure 4-1. Integral Display and the Green/Blue/Red Buttons

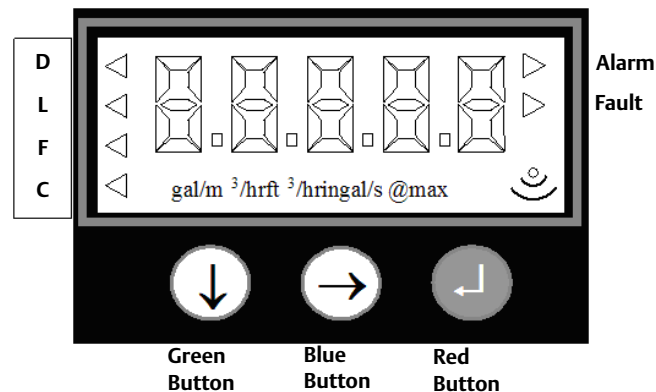

4.2.2 What happens when powering up the transmitter

When the power is turned on, the transmitter takes several seconds to initialize. The display will run through a set-up routine, first illuminating all display characters, and then showing the software revision number. Finally, a full set of zeros is displayed while the microprocessor identifies the correct return echo. After these checks are complete, the display indicates the live measurement based upon the factory default values in memory.

When a new transmitter is aimed at a good target, the level reading is calculated using the default value for the bottom reference.

On the Rosemount 3102 and Rosemount 3105, the duty chosen icon next to letter L (Level) (and the RL2 icon on the 3102) will be illuminated. The RL1 icon on the 3102 may be illuminated, depending on the level calculated by the transmitter at this time.

The transmitter is now ready to be programmed with details of the application. It may be programmed on-site or prior to installation. All programmed data is retained in the transmitter memory after the power is turned off.

4.2.3 Considerations before starting the programming

Important notes to help you program the transmitter

- Do not allow rain or water to enter the transmitter during programming or the circuit boards may be damaged.
- The step-by-step instructions through this chapter show how to use the integral buttons to navigate through the programming menu and select or enter application data.
- Push the buttons firmly, but not too hard to avoid damaging the circuit boards. Also, to avoid entering incorrect data, do not push the buttons too fast.
- The 3102 and 3105 transmitters have a “load default values” routine that restores the transmitter memory with factory default values. This will clear the memory of all previous selected or entered data.

4.3 Programming the 3101 using the integral display and buttons

Note

The Integral Display menu is shown in full in [Appendix C: Integrated Display Menus](#).

4.3.1 Display units (on the 3101)

The display units are indicated by the position of the decimal point in the displayed PV value:

Units	Display
m	8.000
ft.	26.24
in.	314.9

Default values are as follows:

3101****SC*: m

3101****RC*: ft.

Note

See [Figure C-1 on page 102](#) for a map of the programming menu structure showing how to access all the menu options and return to the PV display.

To change the display units

1. Start from the PV display (see the note above).
2. Hold down the blue button → for 10 seconds, but do not release it yet.
3. The display units will then change according to the following sequence:
3101****SC*: Metres to Feet, Feet to Inches, and Inches to Metres
3101****RC*: Feet to Inches, Inches to Metres, and Metres to Feet
4. Continue to hold down the blue button → to change to the next display unit in the above sequence after every three seconds.
5. Confirm the display units by releasing the blue button →.

The same units must be used when programming in the bottom reference and the 4 and 20 mA points. The 4–20 mA output may be set to operate over all or just a part of the total measuring range. There is no limit on the minimum span of the current output, although a span below 4 in. (100 mm) is not recommended. The 4 mA level may be set above or below the 20 mA level to suit the monitoring or control equipment.

Note

The Rosemount 3101 measures and calculates in meters. The display units are derived as a last operation using a pre-programmed conversion factor

4.3.2 First measurements (on the 3101)

With the transmitter installed and display units selected, the display will show what the instrument calculates as the liquid depth (level). This value is calculated by the microprocessor as being the difference between the distance-to-target being measured and the default value for the datum or bottom reference (b.rEF).

Figure 4-2. Transmitter Bottom Reference

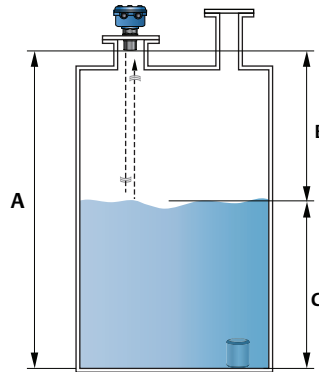

- A. Transmitter Bottom Reference
- B. Distance-to-target
- C. Depth (Level)

Before changing any of the default values, press the blue button → to change the PV display to indicate distance-to-target, as measured by the transmitter from the transmitter face. This value is shown alternately with the text “diSt” to indicate the display is in distance mode. The calculation can be checked against a manual measurement if required.

Note

A useful feature at this stage is that the transmitter can be used as an electronic tape measure. With an empty tank or vessel, the transmitter will read the distance to the bottom of the tank. This distance can be noted and later used when setting b.rEF.

Press the blue button → again to get to the echo size. This is a scale of 0 to 100. (It is possible to record a value greater than 100). With the display in this mode, the central “:” cursor will flash once for every echo received, which under normal circumstances will be once per second.

Note

It is useful at this point to check that the maximum echo size available is being received. Adjust the position of the instrument until the highest echo size is continually shown. In most applications, the signal strength will vary over a wide range: 20 to 80.

Press the blue button → again to return to the original level reading and start the set-up routine, beginning with setting the bottom reference of the transmitter.

Note

The output of the transmitter will vary during programming, as the various default values are changed. The display will automatically revert to the level reading from any other display after a period of four minutes.

4.3.3 Setting the bottom reference (on the 3101)

Screen display: b.rEF
Defaults: 8.000 (m), 26.24 (ft.), 314.9 (in.)

Note

See [Figure C-1 on page 102](#) for a map of the programming menu structure and how to access all the menu options.

To change the bottom reference (b.rEF) setting

1. If entering the menu system from the PV display, press the green button ↓ to indicate the “b.rEF” menu option (see the above note).
2. Press the blue button → to enter the menu for b.rEF. The display indicates the present b.rEF value.
3. If this value is correct, press the red button ↵ and then press the green button ↓ to get to the next menu option. Otherwise, continue with step (4).
4. Press the blue button → to start editing. The first digit flashes to indicate it can be edited.
5. Press the green button ↓ repeatedly to edit the flashing digit.
6. Press the blue button → to move to the next digit. The digit flashes to indicate it can be edited.
7. Repeat steps (5) and (6) until the last digit is flashing, and edited as required.
8. Press the blue button → to confirm the new b.rEF value. None of the digits should now be flashing.
9. Press the red button ↵ to save the new value if it is correct, or press the blue button → to not save. Afterwards, depending on the button pressed, either the “b.rEF” menu or the next menu appears.

4.3.4 Setting 4 mA and 20 mA levels (on the 3101)

Screen display: 4 and 20
4 mA level defaults: 0.000 (m), 00.00 (ft.), 000.0 (in.)
20 mA level defaults: 7.500 (m), 24.60 (ft.), 295.2 (in.)

The 4 mA level may be set above or below the 20 mA level to suit the monitoring or control equipment.

Note

To set the 4 and 20 mA levels by ranging the transmitter to a fixed target, such as the level in the tank at any particular time, skip these menu options by pressing the green button ↓ twice to get to the next menu option.

To change the 4 mA value

1. If entering the menu system from the PV display, press the green button ↓ repeatedly until the “4” menu option is indicated (see above note).
2. Press the blue button → to enter the menu for the 4 mA level. The display indicates the present value of the 4 mA level.
3. If this value is correct, press the red button ↵ and then press the green button ↓ to get to the next menu option. Otherwise, continue with step (4).
4. Press the blue button → to start editing. The first digit will flash to indicate it can be edited.
5. Press the green button ↓ repeatedly to edit the flashing digit.
6. Press the blue button → to move to the next digit. The digit flashes to indicate it can be edited.
7. Repeat steps (5) and (6) until the last digit is flashing, and edited as required.
8. Press the blue button → to confirm the new 4 mA level. None of the digits should now be flashing.
9. Press the red button ↵ to save the new value if it is correct, or press the blue button → to not save. Afterwards, depending on the button pressed, either the “4” menu or the next menu appears.

Note

See [Figure C-1 on page 102](#) for a map of the programming menu structure and how to access all the menu options.

To change the 20 mA value

1. If entering the menu system from the PV display, press the green button ↓ repeatedly until the “20” menu option is indicated (see the above note).
2. Press the blue button → to enter the menu for the 20 mA level. The display indicates the present value of the 20 mA level.
3. If this value is correct, press the red button ↵ and then press the green button ↓ to get to the next menu option. Otherwise, continue with step (4).
4. Press the blue button → to start editing. The first digit flashes to indicate it can be edited.
5. Press the green button ↓ repeatedly to edit the flashing digit.
6. Press the blue button → to move to the next digit. The digit flashes to indicate it can be edited.
7. Repeat steps (5) and (6) until the last digit is flashing, and edited as required.
8. Press the blue button → to confirm the new 20 mA level. None of the digits should now be flashing.

9. Press the red button \downarrow to save the new value if it is correct, or press the blue button \rightarrow to not save. Afterwards, depending on the button pressed, either the “20” menu or the next menu appears.

4.3.5 Setting the output damping (on the 3101)

Screen display: d
Default: 10

The damping value is a time constant in seconds, and is applied as smoothing to the level reading and the output current. A new value may be entered up to 999 seconds. A larger value will have the effect of smoothing out rapid changes of level, and smooth out the effects of turbulence and ripples on the liquid surface. (It would be unusual to select a value greater than 30 seconds).

A value of zero may be edited, in which case no smoothing is applied to the Current Output and transmitter readings immediately change the output.

Note

The Rosemount 3101 transmits nominally at once per second. Therefore, a damping time of zero will not necessarily give an immediate response.

Note

See [Figure C-1 on page 102](#) for a map of the programming menu structure and how to access all the menu options.

To change the output damping

1. If entering the menu system from the PV display, press the green button \downarrow repeatedly until the “d” menu option is indicated (see the above note).
2. Press the blue button \rightarrow to enter the menu “d”. The display indicates the present damping value.
3. If this value is correct, press the red button \downarrow and then the green button \downarrow to get to the next menu option. Otherwise, continue with step (4).
4. Press the blue button \rightarrow to start editing. The first digit flashes to indicate it can be edited.
5. Press the green button \downarrow repeatedly to edit the flashing digit.
6. Press the blue button \rightarrow to select the next digit. The digit flashes to indicate it can be edited.
7. Repeat steps (5) and (6) until the last digit is flashing, and edited as required.
8. Press the blue button \rightarrow to confirm the new damping value. None of the digits should now be flashing.
9. Press the red button \downarrow to save the new value if it is correct, or press the blue button \rightarrow to not save. Afterwards, depending on the button pressed, either the “d” menu or the next menu appears.

4.3.6 Selecting the Lost Echo action (on the 3101)

Screen display:	AL
Default:	Hold

The transmitter signals an alarm condition if the target echo is lost for more than 10 seconds.

There are three options for an alarm condition:

Hi	The current on the two-wire loop will increase to 21 mA and remain there until a correct target echo is recovered. The display flashes alternately “LE” and the alarm action.
Hold	The current will freeze at the value it was last reading and remain there until a correct target echo is recovered. The display flashes alternately “LE” and the last valid reading.
Lo	The current on the two wire loop will decrease to 3.6 mA and remain there until a correct target echo is recovered. The display flashes alternately “LE” and the alarm action.

Note

See [Figure C-1 on page 102](#) for a map of the programming menu structure and how to access all the menu options.

To select a different action

1. If entering the menu system from the PV display, press the green button ↓ repeatedly until the “AL” menu option is indicated (see the above note).
2. Press the blue button → to enter the menu “AL”. The display indicates the present action setting.
3. If this action is correct, press the red button ↵ and then the green button ↓ to get to the next menu option. Otherwise, continue with step (4).
4. Press the blue button → to start editing. The action flashes to indicate it can be edited.
5. Press the green button ↓ repeatedly to scroll through the actions.
6. Press the blue button → to confirm an action. The flashing then stops.
7. Press the red button ↵ to save if the new action is correct, or press the blue button → to not save. Afterwards, depending on the button pressed, either the “AL” menu or the next menu appears.

4.3.7 Setting 4 mA and 20 mA levels using ranging (on the 3101)

Screen display: S--4 and S-20

Note

If the 4 and 20 mA levels are already programmed, as described in the section [“Selecting the Lost Echo action \(on the 3101\)” on page 31](#), this menu option must be skipped; it overwrites previously entered data for them. Press the green button ↓ to get to the final menu option, “Lrn”

This is for setting the 4 mA or 20 mA levels by ranging the instrument to a known target, e.g. the present level in a vessel.

To change the 4 mA level

1. If entering the menu system from the PV display, press the green button ↓ repeatedly until the “S--4” menu option is indicated (see above note).
2. Ensure the target is the 4 mA level and, with the display indicating that level, press the blue button →.
3. The display indicates the present 4 mA level setting, not the new level reading. If this setting is correct, press the red button ↵ and then the green button ↓ to get to the next menu option. Otherwise, continue with step (4).
4. Press the blue button →. The display flashes alternately “4” and the new level reading.
5. Press the blue button → to confirm the new level reading is the new 4 mA level.
6. Press the red button ↵ to save if the new 4 mA level is correct, or press the blue button → to not save. Afterwards, depending on the button pressed, either the “S--4” menu or the next menu appears.

Note

See [Figure C-1 on page 102](#) for a map of the programming menu structure and how to access all the menu options.

To change the 20 mA level

1. If entering the menu system from the PV display, press the green button ↓ repeatedly until the “S-20” menu option is indicated (see the above note).
2. Ensure the target is the 20 mA level and, with the display indicating that level, press the blue button →.
3. The display indicates the present 20 mA level setting, not the new level reading. If this value is correct, press the red button ↵ and then the green button ↓ to get to the next menu option. Otherwise, continue with step (4).
4. Press the blue button →. The display flashes alternately “20” and the new level reading.
5. Press the blue button → to confirm the new level reading is the new 20 mA level.

6. Press the red button \downarrow to save if the new 20 mA level is correct, or press the blue button \rightarrow to not save. Afterwards, depending on the button pressed, either the “S-20” menu or the next menu appears.

4.3.8 Learn about echoes from false targets (on the 3101)

The Rosemount 3101 has an easy-to-use “Lrn” (Learn) routine that allows the instrument to learn up to two false echoes, which can then be ignored in future operations.

If the application is simple and there are no false echoes, press the green button \downarrow to exit the integral display menu and return the instrument to indicating the level reading on the display.

If an echo other than the true liquid surface echo is detected and an incorrect level reading is indicated, the instrument can learn to ignore this false echo. The “Lrn” routine may be used at any time, either during or after setting-up or if a problem occurs later.

Note

See [Figure C-1 on page 102](#) for a map of the programming menu structure and how to access all the menu options.

To store a false target echo

1. If entering the menu system from the PV display, press the green button \downarrow repeatedly until the “Lrn” menu option is indicated (see the above note).
2. Press the blue button \rightarrow to enter the “Lrn” menu. The display indicates “LrnX” where “X” (0, 1, or 2) is the number of stored false target echoes.
3. To exit to the menu at this stage, press the red button \downarrow and then the green button \downarrow to get to the next menu option. Otherwise, continue with step (4).
4. To store a new false echo, hold the blue button down \rightarrow for five seconds.
5. The display alternately flashes “Lrn” and the false target position. After four seconds, the false target position is stored and the display re-indicates “LrnX” alternating with the distance for the stored false echo.
6. Press the red button \downarrow to save this false echo, or press the blue button \rightarrow to not save.
7. To store another false target echo, repeat from step (2). Otherwise, press the green button \downarrow to exit the menu system and return to the PV display.

Note

If there are two false echoes stored (“Lrn2”), the transmitter will not allow another echo to be stored until the memory is cleared (see the next procedure).

When a false echo is stored, the transmitter sets up a ‘window’ around the false target and ignores any echo from that window, unless the echo received from the liquid surface is larger than the stored false echo. There may be no change in the transmitter output current while the liquid level moves through this window, which is equivalent to a distance of 8 in. (20 cm).

Note

See [Figure C-1 on page 102](#) for a map of the programming menu structure and how to access all the menu options.

To clear all the stored false echoes

1. If entering the menu system from the PV display, press the green button ↓ repeatedly until the “Lrn” menu option is indicated (see the above note).
2. Press the blue button → to enter the “Lrn” menu.
3. With the display indicating “LrnX”, press and hold the green button ↓ for ten seconds to clear the memory. The display then indicates “Lrn0”.
4. Press the red button ↵ to exit to the menu.
5. Press the green button ↓ to exit the menu system and change to the PV display.

Programming of the transmitter is now complete and the cover may now be replaced (see [“What to do after completing the cabling” on page 17](#)).

4.3.9 Do final checks

Final checks

1. Check the display is reading correctly.
2. You may wish to check echo size again before re-fitting the enclosure cover.
3. Check that the cover seal is in place in the cover, and is good condition. It should not be twisted or kinked in any way.
4. Carefully set the cover on the transmitter, and tighten the three cover screws equally to seal the instrument.
5. Check that the cable gland is securely tightened and check sealing on the cable sheath.

4.3.10 What happens when a power failure occurs

In the event of a power failure or disconnection from the power supply, the transmitter will remember all parameter values and resume correct operation after power is restored.

4.4 Programming the 3102 and 3105 using the integral display and buttons

Note

The Integral Display menu is shown in full in [Appendix C: Integrated Display Menus](#).

If using a HART Master Device for remote programming of the 3102 or the 3105, refer to the following sections for menu structures and parameters:

- [Appendix D: Rosemount 3490 Series Menus](#)
- [Appendix E: Field Communicator Menus](#)
- [Appendix F: Programming the 3102 and 3105 using HART](#)

4.4.1 Overview of programming the 3102 or the 3105

Transmitter programming is most easily accomplished by *first* selecting the duty that the transmitter is to perform. After a duty is selected (see below), a “mini-wizard” programming assistant is invoked that asks only for information relevant to the selected duty. Entered data allows the mini-wizard to populate relevant parameters with application specific data and select the next step required to configure the transmitter.

Note

It is advised to enter the “dutY” menu when programming the transmitter, initiating the mini-wizard to assist with programming.

After programming is complete, the data entered or calculated by the transmitter can be reviewed by going through the menu using the green button ↓. This is a manual navigation of the menus, and all menus are shown regardless of the duty selected; the mini-wizard is only initiated when a duty is selected. Ignore menus that do not relate to your application.

4.4.2 Selecting the duty (on the 3102/3105)

Screen display: dutY
Default: Level

The arrow icon on the left side of the PV display indicates the selected duty. The Rosemount 3102 and Rosemount 3105 may be programmed to perform one of four duties:

- Distance measurement
- Level measurement
- Flow measurement
- Contents (volume) measurement

To change the duty

1. Press the green button ↓ to enter the menu system from the PV display (see the note above.) The display indicates “dutY”.
2. Press the blue button → to enter the “dutY” menu and display the presently selected duty: “LEVEL”, “Flo”, “cont”, or “diSt”.
3. If the duty is correct, press the red button ↵ and then the green button ↓ to get to the next menu option. Otherwise, continue with step (4).
4. Press the blue button → to start the editing mode. The duty flashes to indicate it may now be edited.
5. Press the green button ↓ repeatedly to scroll through the list of duties.
6. Press the blue button → to confirm the duty. The flashing then stops.
7. Press the red button ↵ to save if the new duty is correct, or press the blue button → to not save. Afterwards, depending on the button pressed, either the “dutY” menu or the next menu appears.

Note

This menu option is in the programming menu. See [Figure C-2 on page 103](#) for a map of the menu structure and how to access the menu options.

4.4.3 Selecting the units of measurement (on the 3102/3105)

Screen display: unitS
Default: m (metric) or ft (Imperial)

Note

- The factory default units of measurement are dictated by the model part number (see “[Ordering information](#)” on page 87)
 - A metric unit can be re-configured to be an Imperial unit, or vice-versa, by changing the transmitter base units. See “[Changing the base units \(on the 3102/3105\)](#)” on page 74
 - Changing base units after programming the transmitter will cause all programmable data to be overwritten with factory default values (which are shown at the beginning of the sections that follow)
-

The transmitter is pre-programmed with selectable measurement units for each of the duties available:

- Distance and Level measurement:
m, ft, in, or none
- Flow measurement:
l/s, l/m, m³/hr, gal/m, ft³/m (cfm), ft³/hr, m ga (MGD), or none
- Contents measurement:
l, m³, gal, or ft³

Note

This menu option is in the programming menu. See [Figure C-2 on page 103](#) for a map of the menu structure and how to access all the menu options.

To change the measurement units

1. If entering the menu system from the PV display, press the green button ↓ repeatedly until the “unitS” menu option is indicated (see note above).
2. Press the blue button → to enter the “unitS” menu. (The presently selected units are indicated on the bottom display line).
3. If the units are correct, press the red button ↵ and then the green button ↓ to exit to the next menu option. Otherwise, continue with step (4).
4. Press the blue button → to start the editing mode. The present units flash to indicate it may be edited.
5. Press the green button ↓ repeatedly to scroll through the list of units.
6. Press the blue button → to confirm the new units. The flashing stops.
7. Press the red button ↵ to save if the new units are correct, or press the blue button → to not save. Afterwards, depending on the button pressed, either the “unitS” menu or the next menu appears.

Note

When using the green button ↓ to scroll through the list of measurement units, allow three seconds after each button press for the transmitter to check and display the selection.

The final option in each set is “none”, which appears as a blank screen. This option is available to the user who requires the display in units other than those available in the standard list of options. In this case, the user will need to scale the PV according to a suitable scaling factor (see [page 44](#)). It is strongly recommended that the user makes a note of the scale factor and the resultant units of measurement, and retain this on a label within the instrument at all times to avoid later confusion. (See parameters P000, P001, or P002 in the appendices).

After changing units, a scaling factor (see [page 44](#)) needs to be edited to see the correct PV value.

4.4.4 Setting the correct bottom reference (on the 3102/3105)

Screen display: b.rEF
Default: 11

The transmitter leaves the factory with the bottom reference pre-programmed to the maximum measurement range of 36 ft. (11 m).

Figure 4-3. Transmitter Bottom Reference

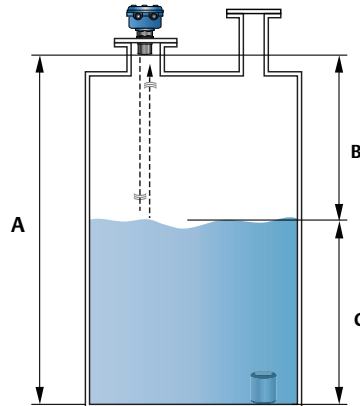

A. Transmitter Bottom Reference
B. Distance-to-target
C. Depth (Level)

To change the bottom reference

1. If entering the menu system from the PV display, press the green button ↓ repeatedly until the “b.rEF” menu option is indicated.
2. Press the blue button → to enter the “b.rEF” menu and display the present bottom reference (b.rEF) value.
3. If this value is correct, press the red button ↵ and then the green button ↓ to get to the next menu option. Otherwise, continue with step (4).
4. Press the blue button → to start the editing mode. The first digit flashes to indicate it can now be edited.
5. Press the green button ↓ repeatedly to edit the flashing digit.
6. Press the blue button → to select the next digit. The digit flashes to indicate it can be edited.
7. Repeat steps (5) and (6) until the last digit is flashing, and edited as required.
8. Press the blue button → to confirm the new b.rEF value. None of the digits should now be flashing.

9. Press the red button \downarrow to save if the new b.rEF value is correct, or press the blue button \rightarrow to not save. Afterwards, depending on the button pressed, either the “b.rEF” menu or the next menu appears.

Note

If the saved duty is Flow or Contents, the next menu option offered is “ProF” (see the section “[Selecting a profile \(on the 3102/3105\)](#)” on page 39).

If the saved duty is Level or Distance, the next menu option offered is “4” (see the section “[Setting the 4 mA point \(on the 3102/3105\)](#)” on page 48).

4.4.5 Selecting a profile (on the 3102/3105)

Screen display: ProF

Factory default value: Lin

This menu is offered if the selected duty is Contents (Volume) or Flow, or is shown when manually navigating the menu system - *this section can be ignored if the selected duty is Level or Distance.*

The transmitter is pre-programmed with popular profiles that are mathematical formulae to convert (scale) a linear level reading to a flow or volumetric PV. Once converted (scaled), the 4–20 mA Output and the integral display will operate according to the flow or volumetric PV.

The profile options are described in the following sub-sections:

- “[Contents \(volume\) measurement](#)” on page 40
- “[Flow measurement](#)” on page 41

Contents (volume) measurement

Lin	Linear (factory default setting)
H.CYL.F	Horizontal cylinder on its side with flat ends
SPH.	Spherical vessel
H.CYL.D	Horizontal cylinder on its side with dished ends

Note

- This menu option is in the programming menu. See [Figure C-2 on page 103](#) for a map of the menu structure and how to access the menu options.
-

To change the contents profile

1. If entering the menu system from the PV display, press the green button ↓ repeatedly until the “ProF” menu option is indicated (see above note).
2. Press the blue button → to enter the “ProF” menu and display the present profile selection.
3. If the selected profile is correct, press the red button ↵ and then the green button ↓ to get to the next menu option. Otherwise, continue with step (4).
4. Press the blue button → to start the editing mode. The selected profile flashes to indicate it can now be edited.
5. Press the green button ↓ repeatedly to scroll through the list of profiles (see above).
6. Press the blue button → to confirm the new profile. (The flashing stops).
7. Press the red button ↵ to save if the new profile is correct, or press the blue button → to not save. Afterwards, depending on the button pressed, either the “ProF” menu or the next menu appears.

Note

If the saved profile is “Lin”, the next menu option offered is “SCALE” (see the section [“Setting the scaling factor \(on the 3102/3105\)” on page 44](#)).

If another contents profile is saved, the next menu offered is “Cont @ max” (see the section [“Maximum contents \(volume\) entry \(on the 3102/3105\)” on page 47](#)).

Flow measurement

Table 4-1 lists the options that select a standard flow structure for the profile and the conversion (scale) factors used to obtain the flow PV.

There are two other profiles:

- SPEC.P
This special plotted option is only visible when the transmitter is configured using a HART Master (see [Appendix F: Programming the 3102 and 3105 using HART](#)).
- SPEC.C
This special calculated option is used when a standard profile is not available from the transmitter's library. A power factor and a K-factor can be edited for an unsupported flow structure or to allow for imperfections in a standard flow structure. (See the sections "[Power factor for the flow law \(on the 3102/3105\)](#)" on page 43 and "[Setting the scaling factor \(on the 3102/3105\)](#)" on page 44).

To change the flow profile

1. If entering the menu system from the PV display, press the green button ↓ repeatedly until the "ProF" menu option is indicated.
2. Press the blue button → to enter the "ProF" menu and display the present profile selection.
3. If the selected profile is correct, press the red button ↵ and then the green button to get to the next menu option. Otherwise, continue with step (4).
4. Press the blue button → to start the editing mode. The selected profile flashes to indicate it can now be edited.
5. Press the green button ↓ repeatedly to scroll through the list of profiles (see SPEC.C above and [Table 4-1 on page 42](#)).
6. Press the blue button → to confirm the new profile. (The flashing stops).
7. Press the red button ↵ to save if the new profile is correct, or press the blue button → to not save. Afterwards, depending on the button pressed, either the "ProF" menu or the next menu appears.

Note

The next menu option will depend upon the flow profile chosen:

3/2 or 5/2: the transmitter automatically calculates the power factor but may require a scaling factor (K-factor) to be entered. See "[Setting the scaling factor \(on the 3102/3105\)](#)" on page 44 for instructions on how to do this.

Manning: the next menu option is "LEUEL @ max" (see "[Maximum level entry \(on the 3102/3105\)](#)" on page 45).

Parshall, FF, or FP: the transmitter automatically calculates the appropriate power factor and scaling factor (K-factor), and automatically sets the 4 mA point at zero flow and the 20 mA point at maximum flow. See "[Setting the output damping \(on the 3102/3105\)](#)" on page 50 for the next relevant section.

Table 4-1. Flow Profile Options

Options	Flow Structures	Hmax		Scale Factor		Power Factor	20 mA Point ⁽¹⁾	
		(m)	(ft./in.)	(m ³ /hour) ⁽²⁾	(GPM) ⁽²⁾		(m)	(ft./in.)
3/2	Flume 3/2 flow law	-	-	(User) ⁽³⁾	(User) ⁽³⁾	1.5	(User) ⁽³⁾	(User) ⁽³⁾
5/2	V-Notch 5/2 flow law	-	-	(User) ⁽³⁾	(User) ⁽³⁾	2.5	(User) ⁽³⁾	(User) ⁽³⁾
mann	Manning formula	-	-	(User) ⁽³⁾	(User) ⁽³⁾	(User) ⁽³⁾	-	-
PAr01	1-in. Parshall flume	0.75	2.5	217.3	151.7	1.55	17.9	87.3
PAr02	2-in. Parshall flume	0.75	2.5	434.6	303.4	1.55	50.7	215
PAr03	3-in. Parshall flume	0.75	2.5	635.5	445.2	1.547	125	516
PAr06	6-in. Parshall flume	0.75	2.5	1372	924.5	1.58	389	1750
PAr09	9-in. Parshall flume	0.75	2.5	1927	1378	1.53	882	3980
PAr1	1 ft. Parshall flume	0.75	2.5	2487	1795	1.522	1610	7240
PAr1.5	1 1/2 ft. Parshall flume	0.75	2.5	3803	2693	1.538	2440	11000
PAr2	2 ft. Parshall flume	0.75	2.5	5143	3590	1.550	3290	14900
PAr3	3 ft. Parshall flume	0.75	2.5	7863	5386	1.566	5010	22600
PAr4	4 ft. Parshall flume	0.75	2.5	10630	7181	1.578	6750	30500
PAr5	5 ft. Parshall flume	0.75	2.5	13440	8976	1.587	8510	38400
PAr6	6 ft. Parshall flume	0.75	2.5	16280	10770	1.595	10300	46400
PAr8	8 ft. Parshall flume	0.75	2.5	22010	14360	1.607	13900	62600
PAr10	10 ft Parshall flume	0.75	2.5	26862	17672	1.6	20700	89200
FF01 ⁽⁴⁾	Flume Flat 1 (m)	0.102	N/A	0.135	N/A	1.5	9	N/A
FF02 ⁽⁴⁾	Flume Flat 2 (m)	0.191	N/A	0.178	N/A	1.5	36	N/A
FF03 ⁽⁴⁾	Flume Flat 3 (m)	0.267	N/A	0.313	N/A	1.5	90	N/A
FF04 ⁽⁴⁾	Flume Flat 4 (m)	0.406	N/A	0.542	N/A	1.5	360	N/A
FF05 ⁽⁴⁾	Flume Flat 5 (m)	0.635	N/A	0.811	N/A	1.5	900	N/A
FF06 ⁽⁴⁾	Flume Flat I	0.200	N/A	0.132	N/A	1.5	30	N/A
FF07 ⁽⁴⁾	Flume Flat II	0.250	N/A	0.178	N/A	1.5	60	N/A
FF08 ⁽⁴⁾	Flume Flat III	0.300	N/A	0.218	N/A	1.5	90	N/A
FF09 ⁽⁴⁾	Flume Flat III bis	0.3333	N/A	0.328	N/A	1.5	200	N/A
FF10 ⁽⁴⁾	Flume Flat III ter	0.400	N/A	0.272	N/A	1.5	200	N/A
FF11 ⁽⁴⁾	Flume Flat IV	0.400	N/A	0.352	N/A	1.5	180	N/A
FF12 ⁽⁴⁾	Flume Flat V	0.500	N/A	0.443	N/A	1.5	360	N/A
FF13 ⁽⁴⁾	Flume Flat V bis	0.400	N/A	0.401	N/A	1.5	320	N/A
FF14 ⁽⁴⁾	Flume Flat VI	0.540	N/A	0.499	N/A	1.5	720	N/A
FF15 ⁽⁴⁾	Flume Flat VII	0.700	N/A	0.624	N/A	1.5	1080	N/A
FF16 ⁽⁴⁾	Flume Flat VIII	0.600	N/A	0.881	N/A	1.5	1440	N/A
FF17 ⁽⁴⁾	Flume Flat VIII bis	0.666	N/A	0.798	N/A	1.5	1500	N/A
FF18 ⁽⁴⁾	Flume Flat IX	0.800	N/A	1.065	N/A	1.5	1800	N/A
FF19 ⁽⁴⁾	Flume Flat IX bis	0.733	N/A	0.815	N/A	1.5	1700	N/A
FF20 ⁽⁴⁾	Flume Flat X	0.867	N/A	1.322	N/A	1.5	3600	N/A
FF21 ⁽⁴⁾	Flume Flat X bis	1.200	N/A	1.609	N/A	1.5	7500	N/A
FF22 ⁽⁴⁾	Flume Flat X ter	0.959	N/A	1.065	N/A	1.5	3500	N/A
FF23 ⁽⁴⁾	Flume Flat XI	1.200	N/A	1.651	N/A	1.5	7200	N/A
FP01 ⁽⁴⁾	Flume Parabolic 1	0.200	N/A	0.399	N/A	2.3	20	N/A
FP02 ⁽⁴⁾	Flume Parabolic 2	0.250	N/A	0.442	N/A	2.3	40	N/A
FP03 ⁽⁴⁾	Flume Parabolic 3	0.310	N/A	0.464	N/A	2.2	90	N/A
FP04 ⁽⁴⁾	Flume Parabolic 4	0.380	N/A	0.544	N/A	2.2	180	N/A
FP05 ⁽⁴⁾	Flume Parabolic 5	0.460	N/A	0.619	N/A	2.1	360	N/A
FP06 ⁽⁴⁾	Flume Parabolic 6	0.600	N/A	0.717	N/A	2.1	720	N/A
FP07 ⁽⁴⁾	Flume Parabolic 7	0.800	N/A	0.772	N/A	2.1	1400	N/A

- (1) Where entries do not say "(User)", the 20 mA Point (Upper Range Value) is automatically set to the value in the meters (m) or feet/inches (ft./in.) column depending on the selected Base Units. The 4 mA Point (Lower Range Value) is automatically set to 0.
- (2) If the Base Units are meters (m), the flow units are m³/hour. Otherwise, flow units are gal/m (GPM). The gallons are US gallons.
- (3) Where shown, "(User)" indicates that the user is required to input the appropriate data.
- (4) FF and FP flume options require the Base Units to be meters (m). See "[Changing the base units \(on the 3102/3105\)](#)" on page 74 if a change of Base Units is required.

4.4.6 Power factor for the flow law (on the 3102/3105)

Screen display: P.FACT
Default: 1.000

This menu option only appears if a flow duty has been selected and a profile (e.g. "SPEC.C") requires the manual editing of a power factor in the formula:

Flow $Q = kh^*$ (where $*$ = the power factor)

The transmitter is pre-programmed with appropriate power factors for many standard flow profiles, and will automatically select the appropriate factor (See [Table 4-1 on page 42](#)). Alternatively, the power factor may be edited to suit a specific flow structure.

To change the power factor

1. If entering the menu system from the PV display, press the green button ↓ repeatedly until the "P.FACT" menu option is indicated (see the above note).
2. Press the blue button → to enter the "P.FACT" menu and display the present power factor.
3. If the power factor is correct, press the red button ↵ and then the green button ↓ to get to the next menu option. Otherwise, continue with step (4).
4. Press the blue button → to start the editing mode. The first digit flashes to indicate it can now be edited.
5. Press the green button ↓ repeatedly to edit the flashing digit.
6. Press the blue button → to move to the next digit. The digit flashes to indicate it can be edited.
7. Repeat steps (5) and (6) until the last digit is flashing, and edited as required.
8. Press the blue button → to confirm the new value. (The flashing stops).
9. Press the red button ↵ to save if the new value is correct, or press the blue button → to not save. Afterwards, depending on the button pressed, either the "P.FACT" menu or the next menu appears.

4.4.7 Setting the scaling factor (on the 3102/3105)

Screen display: SCALE
Default: 1.000

Note

- If a flow duty has been selected, the value entered into this parameter is in effect the K-factor in a flow law of the form $Flow Q = kh^*$
-

If a Distance, Level or Contents (Volume) duty has been selected, the value entered into this parameter is a factor used to scale the measured distance, level, or volume.

For a Level or Distance duty, the scaling factor is normally left at the value calculated by the transmitter (depending upon previously entered data and duty selected), or the default value of 1.000.

For a linear Contents duty, enter a scaling factor to convert the level measurement to a contents (volume) measurement. If the measurement units are “m”, enter the volume contained in 1 m of liquid height in the tank. If the units of measurements are “ft”, then enter the volume contained in 1 ft. of liquid height in the tank.

To change the scale factor

1. If entering the menu system from the PV display, press the green button ↓ repeatedly until the “SCALE” menu option is indicated (see below note).
2. Press the blue button → to enter the “SCALE” menu and to display the present scale factor.
3. If the scale factor is correct, press the red button ↵ and then the green button ↓ to get to the next menu option. Otherwise, continue with step (4).
4. Press the blue button → to start the editing mode. The first digit flashes to indicate it can now be edited.
5. Press the green button ↓ repeatedly to edit the flashing digit.
6. Press the blue button → to move to the next digit. The digit flashes to indicate it can be edited.
7. Repeat steps (5) and (6) until the last digit is flashing, and edited as required.
8. Press the blue button → to confirm the new value. (The flashing stops).
9. Press the red button ↵ to save if the new value is correct, or press the blue button → to not save. Afterwards, depending on the button pressed, either the “SCALE” menu or the next menu appears.

Note

If the existing data entered allows the transmitter to calculate the maximum flow, the 4 mA and 20 mA points are automatically set to 4 mA at zero flow and 20 mA at maximum flow.

4.4.8 Maximum level entry (on the 3102/3105)

Screen display: LEUEL @ max
Default: 1.000

This menu option only appears if a flow duty has been selected, and requires the level to be entered at which the maximum flow occurs.

Note

This menu option is in the programming menu. See [Figure C-2 on page 103](#) for a map of the menu structure and how to access the menu options.

To change the Level@max value

1. If entering the menu system from the PV display, press the green button ↓ repeatedly until the “LEUEL @ max” menu is indicated (see the above note).
2. Press the blue button → to enter the “LEUEL @ max” menu and display the present Level@max value.
3. If the indicated value is correct, press the red button ↵ and then the green button ↓ to get to the next menu option. Otherwise, continue with step (4).
4. Press the blue button → to start the editing mode. The first digit flashes to indicate it can now be edited.
5. Press the green button ↓ repeatedly to edit the flashing digit.
6. Press the blue button → to move to the next digit. The digit flashes to indicate it can be edited.
7. Repeat steps (5) and (6) until the last digit is flashing, and edited as required.
8. Press the blue button → to confirm the new value. (The flashing stops).
9. Press the red button ↵ to save if the new value is correct, or press the blue button → to not save. Afterwards, depending on the button pressed, either the “LEUEL @ max” menu or the next menu appears.

4.4.9 Maximum flow entry (on the 3102/3105)

Screen display: Flo @ max
Default: 1.000

This menu option only appears if a flow duty has been selected, and requires entry of the maximum flow capability of the chosen structure (not the maximum flow expected in the application).

Note

This menu option is in the programming menu. See [Figure C-2 on page 103](#) for a map of the menu structure and how to access the menu options.

To change the Flo@max value:

1. If entering the menu system from the PV display, press the green button ↓ repeatedly until the “Flo @ max” menu is indicated (see the above note).
2. Press the blue button → to enter the “Flo @ max” menu and display the present Flo@max value.
3. If the Flo@max value is correct, press the red button ↵ and then the green button ↓ to get to the next menu option. Otherwise, continue with step (4).
4. Press the blue button → to start the editing mode. The first digit flashes to indicate it can now be edited.
5. Press the green button ↓ repeatedly to edit the flashing digit.
6. Press the blue button → to move to the next digit. The digit flashes to indicate it can be edited.
7. Repeat steps (5) and (6) until the last digit is flashing, and edited as required.
8. Press the blue button → to confirm the new value. (The flashing stops.)
9. Press the red button ↵ to save if the new value is correct, or press the blue button → to not save. Afterwards, depending on the button pressed, either the “Flo @ max” menu or the next menu appears.

Note

If the data entered allows the transmitter to calculate the maximum flow, the 4 and 20 mA points are automatically set to 4 mA at zero flow and 20 mA at maximum flow.

4.4.10 Maximum contents (volume) entry (on the 3102/3105)

Screen display: Cont @ max
Default: 1.000

This menu option is only offered if the selected duty is Contents (Volume), and requires entry of the maximum contents of the vessel.

Note

This menu option is in the programming menu. See [Figure C-2 on page 103](#) for a map of the menu structure and how to access the menu options.

To change the Cont@max value:

1. If entering the menu system from the PV display, press the green button ↓ repeatedly until the “Cont @ max” menu is indicated (see the above note).
2. Press the blue button → to enter the “Cont @ max” menu and display the present Cont@max value.
3. If the Cont@max value is correct, press the red button ↵ and then the green button ↓ to get to the next menu option. Otherwise, continue with step (4).
4. Press the blue button → to start the editing mode. The first digit flashes to indicate it can now be edited.
5. Press the green button ↓ repeatedly to edit the flashing digit.
6. Press the blue button → to move to the next digit. The digit flashes to indicate it can be edited.
7. Repeat steps (5) and (6) until the last digit is flashing, and edited as required.
8. Press the blue button → to confirm the new value. (The flashing stops).
9. Press the red button ↵ to save if the new value is correct, or press the blue button → to not save. Afterwards, depending on the button pressed, either the “Cont @ max” menu or the next menu appears.

4.4.11 Setting the 4 mA point (on the 3102/3105)

Screen Display: 4
Default value: 0.000

Enter the PV value to be signalled by 4 mA. The 4 mA point can be set above or below the 20 mA point to suit monitoring or control equipment.

Note

The 4 and 20 mA points can be set-up by ranging the transmitter to the liquid surface. See “Setting the 4 and 20 mA levels using ranging (on the 3102/3105)” on page 54.

This “4” menu option is in the programming menu. See Figure C-2 on page 103 for a map of the menu structure and how to access the menu options.

To change the 4 mA point

1. If entering the menu system from the PV display, press the green button ↓ repeatedly until the “4” menu option is indicated (see the above note).
2. Press the blue button → to enter the “4” menu and to display the present 4 mA point value.
3. If the 4 mA point value is correct, press the red button ↵ and then the green button ↓ to get to the next menu option. Otherwise, continue with step (4).
4. Press the blue button → to start the editing mode. The first digit flashes to indicate it can now be edited.
5. Press the green button ↓ repeatedly to edit the flashing digit.
6. Press the blue button → to move to the next digit. The digit flashes to indicate it can be edited.
7. Repeat steps (5) and (6) until the last digit is flashing, and edited as required.
8. Press the blue button → to confirm the new value. (The flashing stops).
9. Press the red button ↵ to save if the new value is correct, or press the blue button → to not save. Afterwards, depending on the button pressed, either the “4” menu or the next menu appears.

4.4.12 Setting the 20 mA point (on the 3102/3105)

Screen Display: 20
Default: 10.7

Enter the PV value to be signalled by 20 mA. The 20 mA point may be set above or below the 4 mA point to suit monitoring or control equipment.

Note

The 4 and 20 mA points can be set-up by ranging the transmitter to the liquid surface. See “Setting the 4 and 20 mA levels using ranging (on the 3102/3105)” on page 54.

This “20” menu option is in the programming menu. See Figure C-2 on page 103 for a map of the menu structure and how to access the menu options.

To change the 20 mA point

1. If entering the menu system from the PV display, press the green button ↓ repeatedly until the “20” menu option is indicated (see the above note).
2. Press the blue button → to enter the “20” menu and to display the present 20 mA point value
3. If the 20 mA point is correct, press the red button ↵ and then the green button ↓ to get to the next menu option. Otherwise, continue with step (4).
4. Press the blue button → to start the editing mode. The first digit flashes to indicate it can now be edited.
5. Press the green button ↓ repeatedly to edit the flashing digit.
6. Press the blue button → to move to the next digit. The digit flashes to indicate it can be edited.
7. Repeat steps (5) and (6) until the last digit is flashing, and edited as required.
8. Press the blue button → to confirm the new value. (The flashing stops).
9. Press the red button ↵ to save if the new value is correct, or press the blue button → to not save. Afterwards, depending on the button pressed, either the “20” menu or the next menu appears.

4.4.13 Setting the output damping (on the 3102/3105)

Screen display: d
Default: 3

The damping value is a time constant in seconds, and is applied as smoothing to the displayed PV and the output current.

A new value may be entered up to 999 seconds. A large value will have the effect of smoothing out rapid changes to the PV value, and smooth out the effects of turbulence and ripples on the liquid surface. (It would be unusual to select a value greater than 30 seconds).

A value of zero may be edited, in which case no smoothing is applied to the Current Output and transmitter readings immediately change the output. However, because the 3102 and 3105 transmit nominally at once per second, a damping time of zero will not necessarily give an immediate response.

Note

This menu option is in the programming menu. See [Figure C-2 on page 103](#) for a map of the menu structure, showing how to access the menus.

To change the damping value

1. If entering the menu system from the PV display, press the green button ↓ repeatedly until the “d” menu option is indicated (see the above note).
2. Press the blue button → to enter the “d” menu and to display the present damping value.
3. If the damping value is correct, press the red button ↵ and then the green button ↓ to get to the next menu option. Otherwise, continue with step (4).
4. Press the blue button → to start the editing mode. The first digit flashes to indicate it can now be edited.
5. Press the green button ↓ repeatedly to edit the flashing digit.
6. Press the blue button → to move to the next digit. The digit flashes to indicate it can be edited.
7. Repeat steps (5) and (6) until the last digit is flashing, and edited as required.
8. Press the blue button → to confirm the new value. (The flashing stops).
9. Press the red button ↵ to save if the new value is correct, or press the blue button → to not save. Afterwards, depending on the button pressed, either the “d” menu or the next menu appears.

4.4.14 Selecting the Lost Echo action (on the 3102/3105)

Screen display: AL
Default: Hold

Faults are indicated by a fixed high or low output current, outside the 4–20 mA normal range, and which is selected by the model code that was chosen when ordering the transmitter (see the Special Alarms Options codes in the section “[Ordering information](#)” on page 87).

The exception is that a *separate* output current action can be user-selected for a lost echo condition, where a target echo is lost for 900 seconds or more.

There are three Lost Echo output current actions to choose from:

Hi	The current on the two-wire loop increases to 21.75 mA (for the Rosemount Standard) or 22.5 mA (for NAMUR NE43), depending on the full model code (see “ Ordering information ” on page 87). The current is fixed at that level until the correct target echo is recovered. The display flashes alternately “LE” and the maximum reading (equal to the Bottom Reference setting).
Hold	The current freezes at the last PV value and stays frozen until the correct target echo is recovered. The display flashes alternately “LE” and the last known PV.
Lo	The current on the two-wire loop decreases to 3.75 mA (for Rosemount Standard) or 3.6 mA (for NAMUR NE43), depending on the full model code (see “ Ordering information ” on page 87). The current is fixed at that level until the correct target echo is recovered. The display flashes alternately “LE” and the minimum reading (“0000”).

Note

[Table 5-1 on page 59](#) has a list of faults and alarms.

Faults (e.g. device malfunction) indicated on the output current have priority over the selected lost echo output current action.

Alarms e.g. outside temperature limits, and most faults, are indicated on the display. The 3102 can also indicate faults using its relay outputs.

The 900 seconds is factory set and is changeable in the field (see “[Setting lost echo time \(on the 3102/3105\)](#)” on page 64).

The AL menu option is in the programming menu. See [Figure C-2 on page 103](#) for a map of the menu structure and how to access the menu options.

To change the selected Lost Echo action

1. If entering the menu system from the PV display, press the green button ↓ repeatedly until the “AL” menu option is indicated (see the above note).
2. Press the blue button → to enter the “AL” menu and display the selected action.
3. If the selected action is correct, press the red button ↵ and then the green button ↓ to get to the next menu option. Otherwise, continue with step (4).
4. Press the blue button → to start the editing mode. The selected action flashes to indicate it can now be edited.
5. Press the green button ↓ repeatedly to scroll through the list of actions (see above).
6. Press the blue button → to confirm the new action. (The flashing stops).
7. Press the red button ↵ to save if the new action is correct, or press the blue button → to not save. Afterwards, depending on the button pressed, either the “AL” menu or the next menu appears.

4.4.15 Setting the relay *on* and *off* points (on the 3102)

The Rosemount 3102 has two integral signal relays. Both relays are the SPST (Single Pole, Single Throw) type.

RL1 is factory-set to be a *control relay*. It may be set to energize at any value of PV, and de-energize at any other value of PV. Setting the *on* and *off* points to a common PV will turn the relay off. The *on* value may be greater or smaller than the *off* value, and vice-versa.

RL2 is factory-set to be a *fault relay*. In this mode, it de-energizes while there are Lost Echo (LE) or fault conditions.

The mode of RL2 may be changed to control mode by entering *on* and *off* values (use RL1 instructions below). In control mode, RL2 ceases to be a fault relay until the *on* and *off* values are reset to zero.

All relay set-point values must be entered in the units selected for the PV.

Note

- This menu option is in the programming menu. See [Figure C-2 on page 103](#) for a map of the menu structure and how to access the menu options
-

To change the *on* point for control relay RL1 (or RL2):

1. If entering the menu system from the PV display, press the green button ↓ repeatedly until the “r1 on” (or “r2 on”) menu option is indicated (see the above note).
2. Press the blue button → to enter the “r1 on” (or “r2 on”) menu and display the present On PV value.
3. If the On PV value is correct, press the red button ↵ and then the green button ↓ to get to the next menu option. Otherwise, continue with step (4).

4. Press the blue button → to start the editing. The first digit flashes to indicate it can be edited.
5. Press the green button ↓ repeatedly to edit the flashing digit.
6. Press the blue button → to move to the next digit. The digit flashes to indicate it can be edited.
7. Repeat steps (5) and (6) until the last digit is flashing, and edited as required.
8. Press the blue button → to confirm the new value. (The flashing stops).
9. Press the red button ↵ to save if the new value is correct, or press the blue button → to not save. Afterwards, depending on the button pressed, either the “r1 on” (or “r2 on”) menu or the next menu appears.

Note

- This menu option is in the programming menu. See [Figure C-2 on page 103](#) for a map of the menu structure and how to access the menu options.
-

To change the *off* point for control relay RL1 (or RL2):

1. If entering the menu system from the PV display, press the green button ↓ repeatedly until the “r1 off” (or “r2 off”) menu option is indicated (see the above note).
2. Press the blue button → to enter the “r1 off” (or “r2 off”) menu and display the present Off PV value.
3. If the Off PV value is correct, press the red button ↵ and then the green button ↓ to get to the next menu option. Otherwise, continue with step (4).
4. Press the blue button → to start the editing. The first digit flashes to indicate it can be edited.
5. Press the green button ↓ repeatedly to edit the flashing digit.
6. Press the blue button → to move to the next digit. The digit flashes to indicate it can be edited.
7. Repeat steps (5) and (6) until the last digit is flashing, and edited as required.
8. Press the blue button → to confirm the new value. (The flashing stops).
9. Press the red button ↵ to save if the new value is correct, or press the blue button → to not save. Afterwards, depending on the button pressed, either the “r1 OFF” (or “r2 OFF”) menu or the next menu appears.

4.4.16 Setting the 4 and 20 mA levels using ranging (on the 3102/3105)

Screen display: (SEt 4 and SEt 20)

If you have already programmed the 4 and 20 mA levels as above, you do not need to enter this menu. All the programming is now complete and you should press the red button \downarrow to exit the programming menu and return to the main PV display.

If, however, you wish to set the 4 or 20 mA level by ranging the instrument to a known target - perhaps the level in the vessel at this time - then press the blue button \rightarrow to enter this menu.

Note

The “SEt 4” menu option is in the programming menu. See [Figure C-2 on page 103](#) for a map of the menu structure and how to access the menu options.

To set the 4 mA level

1. If entering the menu system from the PV display, press the green button \downarrow repeatedly until the “SEt 4” menu option is indicated (see the note above).
2. Press the blue button \rightarrow to display the PV at 4 mA.
3. If the value is correct, press the red button \downarrow and then the green button \downarrow to get to the next menu option. Otherwise, continue with step (4).
4. With the transmitter aimed at a target a distance away equivalent to the 4 mA level, press the blue button \rightarrow to start the ranging. The display alternately flashes “4” and the live measurement reading.
5. Press the blue button \rightarrow to confirm the PV at 4 mA is to be changed to the same value as the live measurement reading.
6. Press the red button \downarrow to save if the new value is correct, or press the blue button \rightarrow to not save. Afterwards, depending on the button pressed, either the “SEt 4” menu or the next menu “SEt 20” appears.

Note

The “SEt 20” menu option is in the programming menu. See [Figure C-2 on page 103](#) for a map of the menu structure and how to access the menu options.

To set the 20 mA level

1. If entering the menu system from the PV display, press the green button \downarrow repeatedly until the “SEt 20” menu option is indicated (see note above.)
2. Press the blue button \rightarrow to display the PV at 20 mA.
3. If the value is correct, press the red button \downarrow and then the green button \downarrow to get to the next menu option. Otherwise, continue with step (4)
4. With the transmitter aimed at a target a distance away equivalent to the 20 mA level, press the blue button \rightarrow to start the ranging. The display alternately flashes “20” and the live measurement reading.

5. Press the blue button → to confirm the PV at 20 mA is to be changed to the same value as the live measurement reading.
6. If the new PV at 20 mA value is correct, press the red button ↵ to save and then the green button ↓ to exit the menu system and return to the PV display.
7. Press the red button ↵ to save if the new value is correct, or press the blue button → to not save. Afterwards, depending on the button pressed, either the “SEt 20” menu or the PV display appears.

Programming of the transmitter is now complete. Check the main display to ensure the duty, units, and PV are correct, and that relays are *on* or *off* according to the set points programmed. The cover may now be replaced (see “[What to do after completing the cabling](#)” on page 17).

4.4.17 Do final checks

Final checks

1. Check the display is reading correctly.
2. You may wish to check echo size again before re-fitting the enclosure cover.
3. Check that the cover seal is in place in the cover, and is good condition. It should not be twisted or kinked in any way.
4. Carefully set the cover on the transmitter, and tighten the three cover screws equally to seal the instrument.
5. Check that the cable gland is securely tightened and check sealing on the cable sheath.

4.4.18 What happens when a power failure occurs

In the event of a power failure or disconnection from the power supply, the transmitter will remember all parameter values and resume correct operation after power is restored.

Section 5 Service and Troubleshooting

Safety messages	page 57
Servicing	page 58
Diagnostics for the 3101	page 58
Diagnostics for the 3102 and the 3105	page 59
Engineering menu for the 3102 and 3105	page 62
False echoes under certain ambient operating conditions (on the 3102/3105)	page 75

5.1 Safety messages

Procedures and instructions in this section may require special precautions to ensure the safety of the personnel performing the operation. Information that raises potential safety issues is indicated by a warning symbol (⚠). Refer to the following safety messages before performing an operation preceded by this symbol.

⚠ WARNING

Explosions could result in death or serious injury.

- Verify that the operating environment of the transmitter is consistent with the appropriate approval certifications.
- Before connecting a HART[®]-based communicator in an explosive atmosphere, make sure the instruments in the loop are installed in accordance with intrinsically safe or non-incendive field wiring practices.
- Do not remove the housing cover in explosive atmospheres when the circuit is alive.

Failure to follow safe installation and servicing guidelines could result in death or serious injury.

- Make sure only qualified personnel perform the installation.
- Use the equipment only as specified in this manual. Failure to do so may impair the protection provided by the equipment.
- Do not perform any service other than those contained in this manual unless you are qualified.

High voltage that may be present on leads could cause electrical shock.

- Avoid contact with leads and terminals
 - Make sure the main power to the Rosemount 3101, 3102, and 3105 transmitter is off, and the lines to any other external power source are disconnected or not powered while wiring the transmitter.
-

5.2 Servicing

The only maintenance required is to occasionally check the transmitter face to ensure it remains clean and check that the cover seal, wiring, and cable glands are in good condition.

There are no spare parts for the Rosemount 3101, 3102, and 3105. If a problem persists, contact Rosemount Inc. for advice.

5.3 Diagnostics for the 3101

5.3.1 General troubleshooting

No display

Check the power supply. Ensure there is a minimum of 12 Vdc at the instrument terminals. Check that the cable insulation is not preventing contact at the terminal block.

No level reading

Check that the instrument is ticking about once per second. If there is no ticking, the instrument should be replaced.

5.3.2 Error messages

Flashing “LE” with “0000”

The transmitter is not receiving a return echo, which could mean the liquid surface is poor or that it is beyond the range of 26 ft (8 m) of the instrument. Change the position of the transmitter or contact Emerson Process Management for information on longer range instruments

This means that the transmitter is not receiving a return echo, possibly because the liquid surface is poor or beyond the range (8m/26ft) of the instrument. Re-locate the instrument or contact Rosemount Inc. for details of longer range instruments.

Flashing “LE” with level reading

This means that the transmitter is no longer receiving satisfactory echoes from the liquid surface. This may be because of one of a variety of reasons, for example, excessive foaming, turbulence, or ullage vapors.

First, check that the transmitter face is free from contamination and condensation. The transmitter will operate with some condensation on the face, but excessive condensation may cause operational problems. If the vessel cannot be adequately vented to prevent condensation forming, contact Rosemount Inc. for alternative solutions.

Second, check that the instrument is still vertically aligned above the liquid surface and check the echo received size. If the echo size is small (<3), re-position the transmitter or modify the vessel for the transmitter to operate above a more acceptable area of the liquid surface.

Lost echo (LE) is signalled when there has been no return echo for 10 seconds. Within the 10 seconds, the output will remain fixed. If, after the 10 seconds, no satisfactory has been received,

the output will increase to the current selected level and the display flashes alternately “LE” and the last valid level reading.

If a satisfactory echo is received within the 10 seconds, a new output is established and the LE timer is re-set.

5.4 Diagnostics for the 3102 and the 3105

Menu structures for this section are in [Appendix C: Integrated Display Menus](#).

If using a HART Master Device for programming the 3102 or the 3105, refer to the following sections for menu structures and parameters:

- [Appendix D: Rosemount 3490 Series Menus](#)
- [Appendix E: Field Communicator Menus](#)
- [Appendix F: Programming the 3102 and 3105 using HART](#)

5.4.1 General troubleshooting (on the 3102/3105)

No display

Check the power supply. Ensure there is a minimum of 12 Vdc at the instrument terminals. Check that the cable insulation is not preventing contact at the terminal block.

No level reading

Check that the instrument is ticking about once per second. If there is no ticking, the instrument should be replaced.

5.4.2 Fault and alarms (on the 3102/3105)

Table 5-1. Fault and alarm indication methods

Condition ⁽¹⁾	Alarm or Fault	Current Output	Relay (3102)
Temperature out of limits	Alarm ⁽²⁾	No	No
Field device malfunction	Fault ⁽³⁾	Yes	Yes
ROM checksum error	Fault ⁽²⁾	Yes	Yes
EEPROM signature failure	Fault ⁽²⁾	Yes	Yes
EEPROM checksum error	Fault ⁽²⁾	Yes	Yes
RAM test failure	Fault ⁽²⁾	Yes	Yes
Lost echo	Fault ⁽²⁾	Yes ⁽⁴⁾	Yes

(1) Condition descriptions are abbreviated on the display.

(2) These faults and alarms are displayed alternatively with the PV.

(3) This fault is not displayed.

(4) The current output action can be user-selected for a lost echo condition only.

5.4.3 Diagnostic data (on the 3102/3105)

The Rosemount 3102 and Rosemount 3105 can display diagnostic data that can aid setting-up and fault-finding.

To aid interpretation, the data will alternate with text to remind what data is being displayed. In the diagnostic menu, the data cannot be edited.

To enter the diagnostic menu from the PV display, press the blue button → to display the menu option “diAg”.

Note

See [Figure C-4 on page 105](#) for a map of the diagnostics menu structure.

Diagnostic information is then available by following this sequence:

1. Press the green button ↓ to display the distance-to-target in the selected base units (m, ft, or in.). The transmitter is measuring distance-to-target regardless of the duty selected.

(Press the red button ↵ at any time to re-display the “diAg” menu option, and selecting it again restores the PV display).
2. Press the green button ↓ to get to the next diagnostic data, “LEUEL”.

This is the level measurement in base units that the transmitter has calculated based upon the bottom reference and the distance measured, regardless of the duty chosen for the instrument.
3. Press the green button ↓ to get to the next diagnostic data, “Echo. S”.

This is the echo size being received on a scale of 0 to 100. It is recommended that a value greater than 10 be achieved.
4. Press the green button ↓ to get to the next diagnostic data, “Echo. n”.

This is the number of echoes being received and can be an indicator of the data being processed by the transmitter. A thorough understanding of ultrasonic level systems is required to interpret this data.
5. Press the green button ↓ to get to the next diagnostic data, “F”.

This is the frequency at which the transmitter is operating, and should read between 49 and 58 kHz.
6. Press the green button ↓ to get to the next diagnostic data, “t”.

This is the temperature being recorded by the integral temperature sensor (or remote temperature sensor, if fitted) and is being used by the transmitter to calculate the distance-to-target.
7. Press the green button ↓ and then the blue button → to change to the PV display.

5.4.4 Loop test (on the 3102/3105)

Screen display: tEst

The transmitter can cycle through the programmed operating range without any change in the liquid level, causing the current output to cycle through a normal operation (and energize/de-energize relays on the Rosemount 3102).

The transmitter can be programmed to fix the loop current at any value between 4 and 20 mA to allow testing of any other loop or control instruments.

To enter the loop test menu from the PV display, press the blue button → to display “diAg” and then press-and-hold the blue button → for at two seconds to display “tEst”.

Note

See [Figure C-4 on page 105](#) for a map of the diagnostics menu structure.

Cycle function

Screen display: CyCLE

1. After entering the “tEst” menu (see above), press the green button ↓ to get to the “CyCLE” menu option.
2. Press the blue button → to enter the “CyCLE” menu. The display indicates “0.0000”.
3. Press the blue button → to start the cycle.
For 100 seconds, the transmitter cycles from the 4 mA value to the maximum PV value and back to the 4 mA value again.
Press the green button ↓ at any time to pause and resume the cycle.
4. Press the blue button → to exit the cycle and re-display “CyCLE”.

Loop-current Fixing

Screen display: LOOP

1. From the “tEst” or “CyCLE” display, press the green button ↓ to get to the “LOOP” menu.
2. Press the blue button → to enter the “LOOP” menu, and the display will zero to show “0.000”.
3. Press the blue button → to start the editing mode. The first digit flashes to indicate it can now be edited.
4. Press the green button ↓ repeatedly to edit the flashing digit.
5. Press the blue button → to move to the next digit. The digit flashes to indicate it can be edited.
6. Repeat steps (4) and (5) until the last digit is flashing, and edited as required.
7. Press the blue button → to confirm the fixed loop current.

8. To change the fixed current value to a new value, press the blue button → to return to the “LOOP” menu and re-start at step (2).
9. Press the green button ↓ to return to displaying the “tEst” menu option.
10. From “tEst”, press the red button ↵ to change to the PV display.
Alternatively, from “tEst”, press and hold both the blue → and the red ↵ buttons together for two seconds to get to the Engineering “Eng” menu (see “Engineering menu for the 3102 and 3105” on page 62).

5.5 Engineering menu for the 3102 and 3105

Menu structures for this section are in [Appendix C: Integrated Display Menus](#).

Note

If using a HART Master Device for programming the 3102 or 3105, refer to the following sections for menu structures and parameters:

[Appendix D: Rosemount 3490 Series Menus](#)

[Appendix E: Field Communicator Menus](#)

[Appendix F: Programming the 3102 and 3105 using HART](#)

5.5.1 Accessing the engineering menu (on the 3102/3105)

Screen display: Eng

The transmitter can be fine-tuned if site or application conditions are unusual. It is recommended that all operational fine tuning parameters remain at the factory default settings unless there is a good understanding of the function and capability of the parameters.

The “reload factory defaults” function is found in this menu, and should be used if the transmitter has been configured incorrectly, or if the transmitter needs to be reset to factory default values.

To reach the Engineering menu option “Eng”

1. Begin from the PV display.
([Figure C-2 on page 103](#) is a map of the menu structure).
2. Press the blue button → to indicate the “DiAg” menu option.
(To exit to the PV display, press the red button ↵).
3. Hold down the blue button → for two seconds, and then release.
The display changes to the “tEst” menu option. (To exit to the PV display, press ↵).
4. Hold down both the blue button → and red button ↵ for two seconds.
The display changes to the “Eng” menu option. (To exit to the PV display, press ↵).
5. Press the green button ↓ to enter the “Eng” menu. The display indicates the first engineering menu option “t.hoLd” (see below).

5.5.2 Setting the threshold (on the 3102/3105)

Screen display: t.hoLd
Default: Auto

False echoes are rejected below the threshold value. “Auto” sets the threshold level for optimum performance based on echo sizes being received. A value up to 99 may be entered. However, a large value will have the effect of stopping false echo processing (see “Echo diagnostic” on page 60).

Note

This menu option is in the engineering menu “Eng”. See “Accessing the engineering menu (on the 3102/3105)” on page 62 or see Figure C-5 on page 106 for a map of the menu structure.

To change the threshold value:

1. After entering the “Eng” menu (see the note above), the first menu option indicated is “t.hoLd”.
2. Press the blue button → to enter the menu for “t.hoLd”.
The display indicates the present threshold value.
3. If the threshold value is correct, press the red button ↵ and then press the green button ↓ to get to the next menu option. Otherwise, continue with step (4).
4. Press the blue button → to start the editing mode.
If the present setting is “Auto”, press the green button ↓ to change to a three digit number. The first of the three digits flashes to indicate a number can now be edited.
5. Press the green button ↓ repeatedly to edit the flashing digit.
(To restore the “Auto” setting, scroll past “9”, press the red button ↵ and then press the green button ↓ to get to the next menu option).
6. Press the blue button → to move to the next digit. The digit flashes to indicate it can be edited.
7. Repeat steps (5) and (6) until the last digit is flashing, and edited as required.
8. Press the blue button → to confirm the new value. (The flashing stops).
9. Press the red button ↵ to save the new value if it is correct, or press the blue button → to not save. Afterwards, depending on the button pressed, either the “t.hoLd” menu or the next menu appears.

5.5.3 Setting lost echo time (on the 3102/3105)

Screen display: LE
Default: 900

The lost echo time is the seconds that the transmitter will wait before taking the lost echo action (see “[Selecting the Lost Echo action \(on the 3102/3105\)](#)” on page 51).

A value up to 9999 can be entered. It is recommended that the lost echo time remains set to 900 seconds to avoid false trips and fault/alarm indication from a temporary loss of echo caused by transient poor surface conditions.

A lower lost echo time should only be programmed if it is important that the lost echo action is taken more quickly.

Note

This menu option is in the engineering menu “Eng”. See “[Accessing the engineering menu \(on the 3102/3105\)](#)” on page 62 or see [Figure C-5 on page 106](#) for a map of the menu structure.

To change the lost echo time

1. After entering the “Eng” menu (see the note above), press the green button ↓ repeatedly until “LE” is indicated.
2. Press the blue button → to enter the menu for “LE”. The display indicates the present lost echo time value.
3. If this lost echo time is correct, press the red button ↵ and then press the green button ↓ to get to the next menu option. Otherwise, continue with step (4).
4. Press the blue button → to start the editing mode. The first digit flashes to indicate it can now be edited.
5. Press the green button ↓ repeatedly to edit the flashing digit.
6. Press the blue button → to move to the next digit. The digit flashes to indicate it can be edited.
7. Repeat steps (5) and (6) until the last digit is flashing, and edited as required.
8. Press the blue button → to confirm the new value. (The flashing stops).
9. Press the red button ↵ to save the new value if it is correct, or press the blue button → to not save. Afterwards, depending on the button pressed, either the “LE” menu or the next menu appears.

5.5.4 Setting the dead band (on the 3102/3105)

Screen display: dEAd
Default value: 0.3 (m)

The dead band is a region below the transmitter face in where no measurements can be made. This is also known as the Blanking or Blocking zone, and is a feature common to all ultrasonic level transmitters, with a value dependent upon certain intrinsic properties of the transmitter.

The dead band should not be lower than the factory default minimum value unless advised by the manufacturer. A higher value may be entered to stop the processing of echoes from false targets, but real echoes in the dead band will also now be ignored.

Note

This menu option is in the engineering menu “Eng”. See [“Accessing the engineering menu \(on the 3102/3105\)” on page 62](#) or see [Figure C-5 on page 106](#) for a map of the menu structure.

To change the dead band:

1. After entering the “Eng” menu (see the note above), press the green button ↓ repeatedly until “dEAd” is indicated.
2. Press the blue button → to enter the dead band menu. The display indicates the present dead band value.
3. If this dead band is correct, press the red button ↵ and then press the green button ↓ to get to the next menu option. Otherwise, continue with step (4).
4. Press the blue button → to start the editing mode. The first digit flashes to indicate it can now be edited.
5. Press the green button ↓ repeatedly to edit the flashing digit.
6. Press the blue button → to move to the next digit. The digit flashes to indicate it can be edited.
7. Repeat steps (5) and (6) until the last digit is flashing, and edited as required.
8. Press the blue button → to confirm the new value. (The flashing stops).
9. Press the red button ↵ to save the new value if it is correct, or press the blue button → to not save. Afterwards, depending on the button pressed, either the “dEAd” menu or the next menu appears.

5.5.5 Setting the frequency (on the 3102/3105)

Screen display: F
Default: Auto

The frequency at which the transmitter operates is automatically chosen by the microprocessor to ensure optimum signal size and performance.

“Auto” sets the frequency to obtain the best echo size and optimum performance. The actual frequency being used by the transmitter can be viewed in diagnostics (see [page 60](#)).

The limits of operating frequency are a function of the intrinsic properties of the transmitter itself, and may be set to operate at any frequency between 49 and 58 kHz.

The transmit frequency affects the quality of the echo being received, which may be used to improve a poor echo or reduce the quality of a false echo.

Note

This menu option is in the engineering menu “Eng”. See [“Accessing the engineering menu \(on the 3102/3105\)” on page 62](#) or see [Figure C-5 on page 106](#) for a map of the menu structure.

To change the frequency

1. After entering the “Eng” menu (see the note above), press the green button ↓ repeatedly until “F” is indicated.
2. Press the blue button → to enter the frequency menu. The display indicates the present frequency setting.
3. If this frequency is correct, press the red button ↵ and then press the green button ↓ to get to the next menu option. Otherwise, continue with step (4).
4. Press the blue button → to start the editing mode. The present frequency setting flashes to indicate it can be edited.
5. Press the green button ↓ repeatedly to scroll through available options (49 to 58 kHz). (To restore the “Auto” setting, scroll past “58 kHz” and press the red button ↵ to save and exit).
6. Press the blue button → to confirm the new setting. (The flashing stops).
7. Press the red button ↵ to save the new setting if it is correct, or press the blue button → to not save. Afterwards, depending on the button pressed, either the “F” menu or the next menu appears.

5.5.6 Setting the pulse repetition frequency (on the 3102/3105)

Screen display: Prf
Default: 1.0

The rate of pulses transmitted is set to a factory default value of once-per-second.

The pulse repetition frequency may be changed to overcome cross talk problems if more than one ultrasonic transmitter is mounted in the same tank.

The transmitter may be set to transmit faster or slower at selectable repetition rates between 0.5 and 2.0 times per second.

Note

This menu option is in the engineering menu “Eng”. See “[Accessing the engineering menu \(on the 3102/3105\)](#)” on page 62 or see [Figure C-5 on page 106](#) for a map of the menu structure.

To change the pulse repetition frequency:

1. After entering the “Eng” menu (see the note above), press the green button ↓ repeatedly until “Prf” is indicated.
2. Press the blue button → to enter the pulse frequency menu. The display indicates the present frequency value.
3. If this pulse frequency is correct, press the red button ↵ and then press the green button ↓ to get to the next menu option. Otherwise, continue with step (4).
4. Press the blue button → to start the editing mode. The pulse repetition frequency flashes to indicate it can be edited.
5. Press the green button ↓ repeatedly to scroll through the available options (0.5 to 2.0).
6. Press the blue button → to confirm the new setting. (The flashing stops).
7. Press the red button ↵ to save the new setting if it is correct, or press the blue button → to not save. Afterwards, depending on the button pressed, either the “Prf” menu or the next menu appears.

Note

There is an increased risk of a Lost Echo condition if this parameter value is set to too high.

5.5.7 Setting valid echo count (on the 3102/3105)

Screen display: Stir

Factory default value: 4

This parameter is normally used in vessels with a stirrer or agitator, particularly if there is slow movement. The transmitter may detect uncovered blades and treat them as a valid echo and calculate an incorrect level reading.

Note

This menu option is in the engineering menu “Eng”. See “[Accessing the engineering menu \(on the 3102/3105\)](#)” on page 62 or see [Figure C-5](#) on page 106 for a map of the menu structure.

To change the valid echo count:

1. After entering the “Eng” menu (see the note above), press the green button ↓ repeatedly until “Stir” is indicated.
2. Press the blue button → to enter the stirrer (“Stir”) menu. The display indicates the present valid echo count.
3. If the value indicated is correct, press the red button ↵ and then press the green button ↓ to get to the next menu option. Otherwise, continue with step (4).
4. Press the blue button → to start the editing mode. The valid echo count flashes to indicate it can be edited.
5. Press the green button ↓ repeatedly to scroll through the options available (1 to 100).
6. Press the blue button → to confirm the new setting. (The flashing stops).
7. Press the red button ↵ to save the new setting if it is correct, or press the blue button → to not save. Afterwards, depending on the button pressed, either the “Stir” menu or the next menu appears.

5.5.8 Setting spike rejection (on the 3102/3105)

Screen display: SPi
Default: 0 (disabled)

In applications with high levels of acoustic or electrical noise, a spike could incorrectly trigger the echo detection system. The value of SPi can be increased (0 to 100) and has the effect of rejecting spikes. Several different values may have to be tried to determine the best option.

Note

- This menu option is in the engineering menu “Eng”. See “[Accessing the engineering menu \(on the 3102/3105\)](#)” on page 62 or see [Figure C-5 on page 106](#) for a map of the menu structure

To change the spike rejection

1. After entering the “Eng” menu (see the note above), press the green button ↓ repeatedly until “SPi” is indicated.
2. Press the blue button → to enter the spike rejection menu. The display indicates the present SPi value
3. If this SPi is correct, press the red button ↵ and then press the green button ↓ to get to the next menu option. Otherwise, continue with step (4).
4. Press the blue button → to start the editing mode. The SPi flashes to indicate it can be edited.
5. Press the green button ↓ repeatedly to scroll through the options available (1 to 100).
6. Press the blue button → to confirm the new setting. (The flashing stops).
7. Press the red button ↵ to save the new setting if it is correct, or press the blue button → to not save. Afterwards, depending on the button pressed, either the “SPi” menu or the next menu appears.

5.5.9 Learn about echoes from false targets (on the 3102/3105)

Screen display: Lrn

The Rosemount 3102 and Rosemount 3105 has an easy-to-use “Lrn” (Learn) routine that allows the instrument to learn up to four false echoes, which can then be ignored in future operations.

If the application is simple and there are no false echoes, press the green button ↓ to exit the menu and return to the PV display.

After the transmitter is in operational, if an echo other than the true liquid surface echo is detected and an incorrect level reading is indicated, the instrument can learn to ignore this false echo. The “Lrn” routine may be used at any time, either during or after setting-up or if a problem occurs later.

Note

- This menu option is in the engineering menu “Eng”. See “[Accessing the engineering menu \(on the 3102/3105\)](#)” on page 62 or see [Figure C-5 on page 106](#) for a map of the menu structure.

To store a false target echo

1. After entering the “Eng” menu (see the note above), press the green button ↓ repeatedly until “Lrn” is indicated.
2. Press the blue button → to enter the “Lrn” menu. The display indicates “LrnX” where “X” (0 to 4) is the number of stored false target echoes.
3. To store a new false echo, press and hold the blue button → for five seconds.
4. The display alternately flashes “Lrn” and the false target position. After four seconds, the false target position is stored and the display re-indicates “LrnX”.
5. Press the red button ↵ to save this false echo and exit to the menu. If this false echo shouldn't be saved, press the blue button → to exit the menu.
6. To store another false target echo, re-start at step (2).
7. To get to the next menu option, press the green button ↓.

Note

If there are four false echoes stored (“Lrn4”), the transmitter will not allow another echo to be stored until the memory is cleared (see procedure below).

Note

When a false echo is stored, the transmitter sets up a 'window' around the false target and ignores any echo from that window, unless the echo received from the liquid surface is larger than the stored false echo. There may be no change in the transmitter output current while the liquid level moves through this window, which is equivalent to a distance of 20 cm.

To clear all the stored false echoes

1. After entering the “Eng” menu (see the note above), press the green button ↓ repeatedly until “Lrn” is indicated.
2. Press the blue button → to enter the “Lrn” menu.
3. With the display indicating “LrnX”, press and hold the green button ↓ for ten seconds to clear the memory. The display then indicates “Lrn0”.
4. To exit to the menu system press the red button ↵. The menu option “Lrn” re-appears.
5. See the previous procedure for how to store new false echoes or press the green button ↓ to get to the next menu option.

5.5.10 Setting the ambient temperature (on the 3102/3105)

Screen display: t
Default value: Auto

The transmitter has an integral temperature sensor to measure the temperature of the air space surrounding it so that the speed of sound can be correctly computed for sending pulses. The distance-to-target is then calculated using the formula:

$$\text{Distance to target} = (\text{Speed of Sound in air} * \text{Time for echo to return}) / 2)$$

Auto indicates the transmitter is set to continuously measure the temperature using the integral temperature sensor. It may, occasionally, be necessary to over-ride this automatic monitoring and fix the temperature to be used in speed-of-sound calculations, for example if the air temperature is not uniform and the temperature being recorded is not the true air temperature.

Note

This menu option is in the engineering menu “Eng”. See [“Accessing the engineering menu \(on the 3102/3105\)” on page 62](#) or see [Figure C-5 on page 106](#) for a map of the menu structure.

To edit and fix the temperature

1. After entering the “Eng” menu (see the note above), press the green button ↓ repeatedly until “t” is indicated.
2. Press the blue button → to enter the temperature menu. The display indicates the present setting.
3. If this setting is correct, press the red button ↵ and then press the green button ↓ to get to the next menu option. Otherwise, continue with step (4).
4. Press the blue button → to start the editing mode. If the present setting is “Auto”, press the green button ↓ to change to a three digit number. The first of the three digits flashes to indicate a number can now be edited.
5. Press the green button ↓ repeatedly to edit the flashing digit.
(To restore the “Auto” setting, scroll past “9”, press the red button ↵ to save, and then press the green button ↓ to get to the next menu option).
6. Press the blue button → to move to the next digit. The digit flashes to indicate it can be edited.
7. Repeat steps (5) and (6) until the last digit is flashing, and edited as required.
8. Press the blue button → to confirm the new value. (The flashing stops).
9. Press the red button ↵ to save the new setting if it is correct, or press the blue button → to not save. Afterwards, depending on the button pressed, either the “t” menu or the next menu appears.

The next menu is “t.CAL” if using the optional Remote Temperature Sensor to measure the air temperature. If the Remote Temperature Sensor option is not fitted, the next menu is “Ld.dEF” (see [“Loading factory default values \(on the 3102/3105\)” on page 73](#)).

5.5.11 Temperature calibration (on the 3102/3105)

Screen display: t.CAL

This menu option only appears if using the optional Remote Temperature Sensor to monitor air temperature (see [“Remote temperature sensor”](#) on page 21).

Note

Due to the effects of cable length and electronic component tolerances, the air temperature measurement by the Remote Temperature Sensor could have an error of ± 0.5 °C if calibration is not performed.

The recorded temperature can be trimmed to match a another plant reading.

Note

This menu option is in the engineering menu “Eng”. See [“Accessing the engineering menu \(on the 3102/3105\)”](#) on page 62 or see [Figure C-5 on page 106](#) for a map of the menu structure.

To edit and fix the temperature

1. After entering the “Eng” menu (see the note above), press the green button ↓ repeatedly until “t.CAL” is indicated.
2. Press the blue button → to enter the “t.CAL” menu. The display indicates the present setting.
3. If this setting is correct, press the red button ↵ and then press the green button ↓ to get to the next menu option. Otherwise, continue with step (4).
4. Press the blue button → to start the editing mode. The first digit flashes to indicate it can now be edited.
5. Press the green button ↓ repeatedly to edit the flashing digit.
6. Press the blue button → to move to the next digit. The digit flashes to indicate it can be edited.
7. Repeat steps (5) and (6) until the last digit is flashing, and edited as required.
8. Press the blue button → to confirm the new value. (The flashing stops).
9. Press the red button ↵ to save the new setting if it is correct, or press the blue button → to not save. Afterwards, depending on the button pressed, either the “t.CAL” menu or the next menu appears.

5.5.12 Loading factory default values (on the 3102/3105)

Screen display: Ld.dEF

It may, occasionally, be necessary to re-set the transmitter parameters to factory default values, particularly if the data already changed is in question.

Note

Re-loading factory defaults overwrites all parameters and all site entered data will be lost.

To ensure that this operation is not initiated by accident, a specific integral button sequence is necessary to load factory defaults.

Note

This menu option is in the engineering menu “Eng”. See “[Accessing the engineering menu \(on the 3102/3105\)](#)” on page 62 or see [Figure C-5 on page 106](#) for a map of the menu structure.

To load factory default values

1. After entering the “Eng” menu (see the note above), press the green button ↓ repeatedly until “Ld.dEF” is indicated.
2. Press the blue button → to enter the load defaults “Ld.dEF” menu and display “LOAd”.
3. Press and hold the blue button → for two seconds to flash the screen message “SUrE”.
4. Press the blue button → again to acknowledge the message and stop the message flashing.
5. If you do not want to continue, press the blue button → to abort and then press the green button ↓ to get to the next menu option. Otherwise, continue with step (6).
6. To load factory defaults, press and hold both the blue → and red ↵ buttons together for two seconds.

The screen flashes “b.units” and reloads all factory default values. The display then changes to the PV display.

5.5.13 Changing the base units (on the 3102/3105)

Screen display: b.unit
Default: metric (m) or imperial (ft)

The transmitter may be re-configured to operate in a choice of base units:

- meters
- feet
- inches

Note

If the base units are changed, the transmitter automatically re-starts as if it was a new instrument on first power-up, but will default to the chosen base units and load factory default values into all other parameters.

Note

This menu option is in the engineering menu “Eng”. See [“Accessing the engineering menu \(on the 3102/3105\)” on page 62](#) or see [Figure C-5 on page 106](#) for a map of the menu structure.

To change the base units

1. After entering the “Eng” menu (see the note above), press the green button ↓ repeatedly until “b.unit” is indicated.
2. Press the blue button → to enter the base units selection menu.
The display indicates the present base units on the bottom display line.
3. If these base units are correct, press the red button ↵ and then press the green button ↓ to get to the next menu option. Otherwise, continue with step (4).
4. Press the blue button → to start the editing mode. The base units flash to indicate they can be edited.
5. Press the green button ↓ repeatedly to scroll through the three options.
6. Press the blue button → to confirm the selected base units. (The flashing stops.)
7. If the new setting is correct, press the red button ↵ to save. The transmitter automatically re-starts as if it was a new instrument on first power-up (see [“What happens when powering up the transmitter” on page 25](#)).

If the new setting is incorrect, press the blue button → to exit to the menu. The menu option “b.unit” re-appears allowing you to re-start at step (2), or press the green button ↓ and then the blue button → to resume the PV display.

5.6 False echoes under certain ambient operating conditions (on the 3102/3105)

In applications where elevated ambient temperatures of around 122 to 140 °F (50 to 60 °C) are experienced, together with poor liquid surface conditions (excessive surface agitation, foam, etc.), the 3102 and 3105 transmitters may see a false echo and report a false high level measurement.

To overcome this issue, the near zone threshold (Threshold 1 Size P048) was changed from software version V4.02 onwards to provide the following duty:

- **Threshold 1 Size P048**

The factory default value of this parameter is **6%** (prior to V4.02 software this had a default value of 4%).

If Threshold 1 Size **P048** is *equal to* 6.0 (default), the transmitter automatically adjusts the value of the initial threshold in use at elevated temperatures to eliminate false high level readings.

If Threshold 1 Size **P048** is *set to* 6.0 **and** Threshold 1 Time **P043** is *equal to* 2.9 (default), the transmitter simultaneously adjusts the value of the initial threshold time in use at higher temperatures.

If Threshold 1 Size **P048** is *not equal to* 6.0, the unit uses that value and Threshold 1 Time **P043** will be as programmed.

Note that operating at elevated ambient temperatures over 140 °F (50 °C) may have an impact on the accuracy of the liquid level reading when the liquid level is within approximately 0.5 m of the transducer face. The accuracy may be reduced from ±2.5 mm to +2.5/-5.5 mm or, in extreme conditions, +2.5/-8.5 mm.

Note

Parameters P048 and P043 are accessible only when using a Field Communicator, Device Manager, or a Rosemount 3490 Series Control Unit. The main descriptions for these parameters are on pages 181 to 182 in [Appendix F: Programming the 3102 and 3105 using HART](#).

Appendix A Reference Data

Specifications	page 77
Dimension drawings	page 84
Ordering information	page 87
Spare parts and accessories	page 90

A.1 Specifications

A.1.1 General

Product

Rosemount 3100 Series Liquid Level Transmitters:

- Rosemount 3101: Level
- Rosemount 3102:
Level, Distance, Content (Volume) and Flow measurement, with two integral signal relays
- Rosemount 3105:
Level, Distance, Content (Volume) and Flow measurement, for hazardous locations

Measurement principle

Ultrasonic, time-of-flight

A.1.2 Measuring performance

Measurement range

Rosemount 3101: 1 to 26 ft (0,3 to 8 m)

Rosemount 3102: 1 to 36 ft (0,3 to 11 m)

Rosemount 3105: 1 to 36 ft (0,3 to 11 m)

Accuracy under reference conditions⁽¹⁾

Rosemount 3101:
± 0.2 in. (5 mm) for < 3.3 ft. (1 m), ± 0.5% of measured distance for > 3.3 ft. (1 m)

Rosemount 3102 and Rosemount 3105⁽²⁾:
± 0.1 in. (2,5 mm) < 3.3 ft (1 m), ±0.25% of measured distance for > 3.3 ft. (1 m)

(1) Temperature: 68 °F (20 °C), Pressure: 1013 mbar (atmospheric pressure), and Relative Humidity: 50%.

(2) GOST-approved 3102 and 3105: see the Russian product data sheet 00813-0107-4840 for revised accuracy of measured distances less than 3.3 ft. (1 m).

Level resolution

Better than 0.04 in. (1 mm)

Blanking distance (dead zone)

12 in. (0,3 m)

Update interval

Display: 500 ms; Current Output: 200 ms

A.1.3 Display and configuration

Integral display

4/5 digit display for live measurement and for configuration purposes

Output units

Rosemount 3101: m, ft., in.

Rosemount 3102/3105:

Level or distance-to-surface: m, ft., in.

Contents: l, m³, gal, ft³

Flow: l/s, l/m, m³/hr, gal/m, ft³/m (cfm), ft³/hr, or mga

Output variables

Rosemount 3101: Level

Rosemount 3102: Level (or distance-to-surface), Content (Volume), and Flow

Rosemount 3105: Level (or distance-to-surface), Content (Volume), and Flow

Configuration tools

Standard integral push-buttons with LCD

Field Communicator⁽¹⁾

Rosemount 3490 Series Universal Control Unit⁽¹⁾

AMS Suite: Intelligent Device Manager⁽¹⁾

(1) This configuration tool uses HART which is not supported on the Rosemount 3101.

A.1.4 Electrical

Power supply

Loop-powered (two-wire)

Rosemount 3101: 12 to 30 Vdc

Rosemount 3102: 12 to 40 Vdc

Rosemount 3105: 12 to 40 Vdc (non-hazardous area), 12 to 30 Vdc (hazardous area)

Earthing

None required

Current Output

Rosemount 3101: Analog 4–20 mA

Rosemount 3102: Analog 4–20 mA, HART

Rosemount 3105: Analog 4–20 mA, HART

Signal-on-alarm

3101: Low = 3.6 mA. High = 21 mA

3102/3105⁽¹⁾:

Standard: Low = 3.75 mA. High = 21.75 mA;

Namur NE43: Low = 3.6 mA. High = 22.5 mA

Saturation levels

3101: Low = 3.8 mA. High = 20.5 mA

3102/3105⁽¹⁾:

Standard: Low = 3.9 mA. High = 20.8 mA;

Namur NE43: Low = 3.8 mA. High = 20.5 mA

Relay output (Rosemount 3102)

Two integral signal relays, SPST rated 1A @ 30 Vdc (inductive) and 2A @ 30 Vdc (resistive)

Electrical parameters

$U_i = 30\text{ V}$, $I_i = 120\text{ mA}$, $P_i = 0,82\text{ W}$, $L_i = 108\text{ }\mu\text{H}$, $C_i = 0\text{ nF}$ (for 3105 hazardous area approvals)

(1) If no Special Alarm option code is selected when ordering the 3102 or 3105 transmitter, the configuration is pre-set for a high-signal alarm indication, and standard Rosemount alarm and saturation levels (see [Table A-2 on page 88](#) or [Table A-3 on page 89](#) for the option codes). Alarms and faults are discussed on [page 51](#).

Cable entry

Aluminum housing:
Two ½" - 14 NPT conduit entries for cable glands.
Option: M20 x 1.5 conduit/cable adaptor

Glass-filled nylon housing:
Two M20 x 1.5 conduit entries for cable glands.

Output cabling

Single twisted-pair and shielded, min. 0,22 mm² (24 AWG), max. 1,5 mm² (15 AWG)

A.1.5

Materials

Materials selection

Emerson provides a variety of Rosemount product with various product options and configurations including materials of construction that can be expected to perform well in a wide range of applications. The Rosemount product information presented is intended as a guide for the purchaser to make an appropriate selection for the application. It is the purchaser's sole responsibility to make a careful analysis of all process parameters (such as all chemical components, temperature, pressure, flow rate, abrasives, contaminants, etc.), when specifying product, materials, options and components for the particular application. Emerson Process Management is not in a position to evaluate or guarantee the compatibility of the process fluid or other process parameters with the product, options, configuration or materials of construction selected.

Materials of construction

Wet-side material: PVDF

Body and cover material: polyurethane-covered aluminum or glass-filled nylon

Cover seal: silicone rubber

Cover screws: 316 Stainless Steel

Transducer body seal: EPDM

A.1.6

Mechanical

Mounting thread size

2-in. NPT, or 2-in. BSP. Optional flange accessories available

Weight of transmitter

Rosemount 3101 with aluminum housing: 3.1 lb (1,4 kg)

Rosemount 3102 with aluminum housing: 3.3 lb (1,5 kg)

Rosemount 3105 with aluminum housing: 4.4 lb (2,0 kg)

Rosemount 3101 with glass filled nylon housing: 2.0 lb (0,9 kg)

Rosemount 3102 with glass filled nylon housing: 2.2 lb (1,0 kg)

Rosemount 3105 with glass filled nylon housing: 3.1 lb (1,4 kg)

A.1.7 Measuring

Temperature compensation⁽¹⁾

Rosemount 3101: Automatic Integral temperature compensation

Rosemount 3102:
Automatic Integral temperature compensation. Optional remote temperature sensor for dynamic temperature compensation

Rosemount 3105:
Automatic Integral temperature compensation. Optional remote temperature sensor for dynamic temperature compensation

A.1.8 Environment

Ambient temperature⁽²⁾

Rosemount 3101:
-4 to 158 °F (-20 to 70 °C)

Rosemount 3102 and Rosemount 3105:
-40 to 158 °F (-40 to 70 °C)

Process temperature

Rosemount 3101:
-4 to 158 °F (-20 to 70 °C)

Rosemount 3102 and Rosemount 3105:
-22 to 158 °F (-30 to 70 °C)

Process pressure

-4 to 44 psi (-0,25 to 3,0 bar)

(1) See [page 90](#) for optional accessories.

(2) See [page 82](#) onwards for approval temperature ranges.

Ingress protection

NEMA 4X, IP 66 for aluminum housing
(requires a suitably rated cable gland/blanking plug – not supplied)

IP 66/67 for glass-filled nylon housing
(when using the supplied cable gland and blanking plug)

Electromagnetic compatibility

EN61326 (Class B)

Certifications

CE-mark, FM, CSA, ATEX, or IECEx (dependent on order code)

A.1.9 Temperature and pressure ratings

The process temperature/pressure rating depends on the design of the transmitter in combination with the flange materials.

Figure A-1. Process Temperature and Pressure Chart for the Rosemount 3100 Series

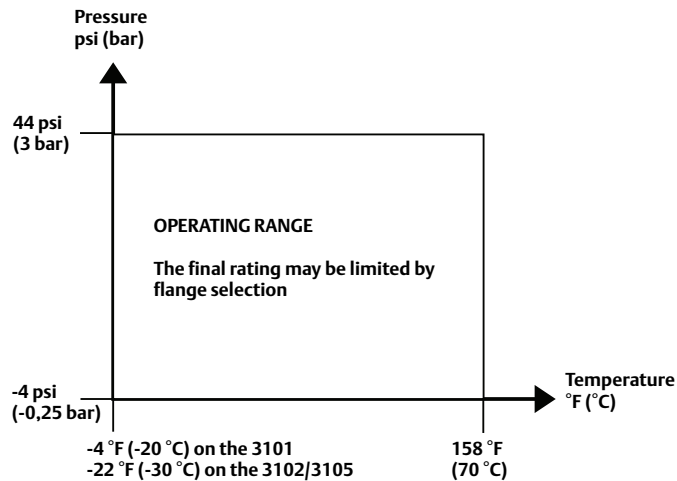

A.1.10 Load limitations

A Field Communicator requires a minimum load resistance of 250 Ohm within the loop in order to function properly. Communication with the Rosemount 3490 Series Controller does not require additional resistance. The maximum load resistance can be determined from Figure A-2.

Figure A-2. Load Limitations Charts

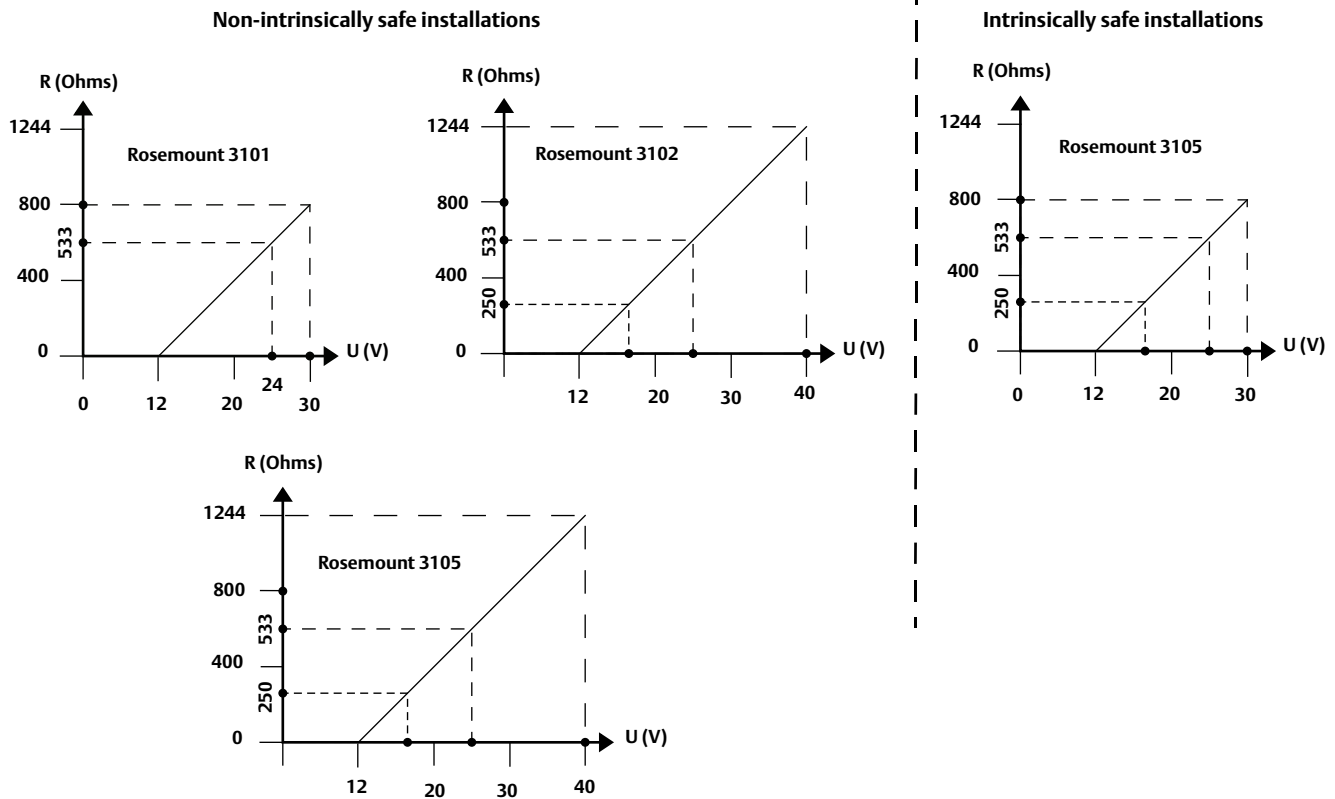

Note

R = Maximum Load Resistance.
 U = External Power Supply Voltage.

A.2 Dimension drawings

Figure A-3. Transmitter Dimensions (Aluminum Housing)

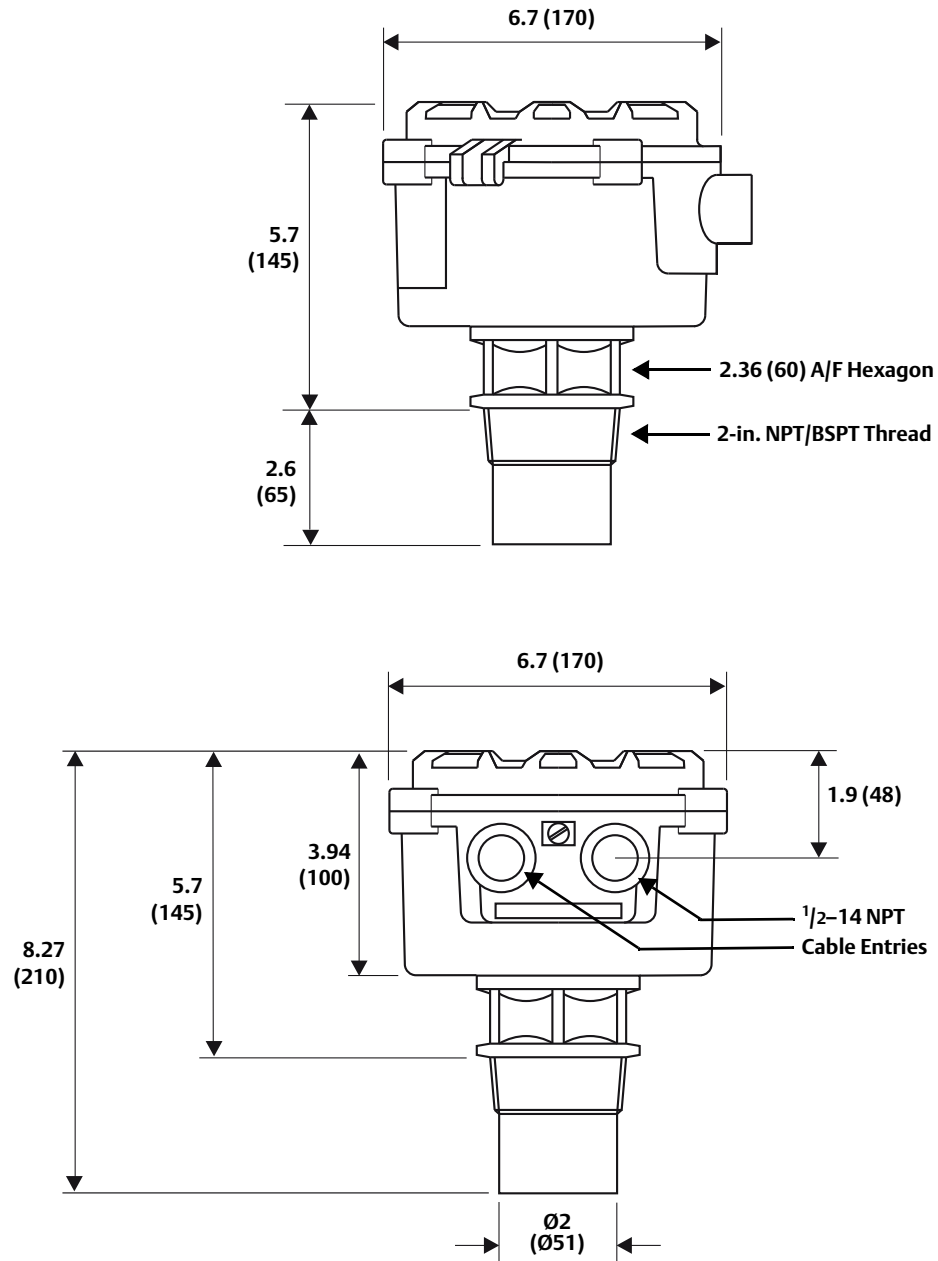

Note

Dimensions are in inches (mm).

1/2-14 NPT to M20 x 1.5 Adaptors are available when ordering the transmitter. See “[Ordering information](#)” on page 87.

Figure A-4. Transmitter Dimensions (Nylon-filled Glass Housing)

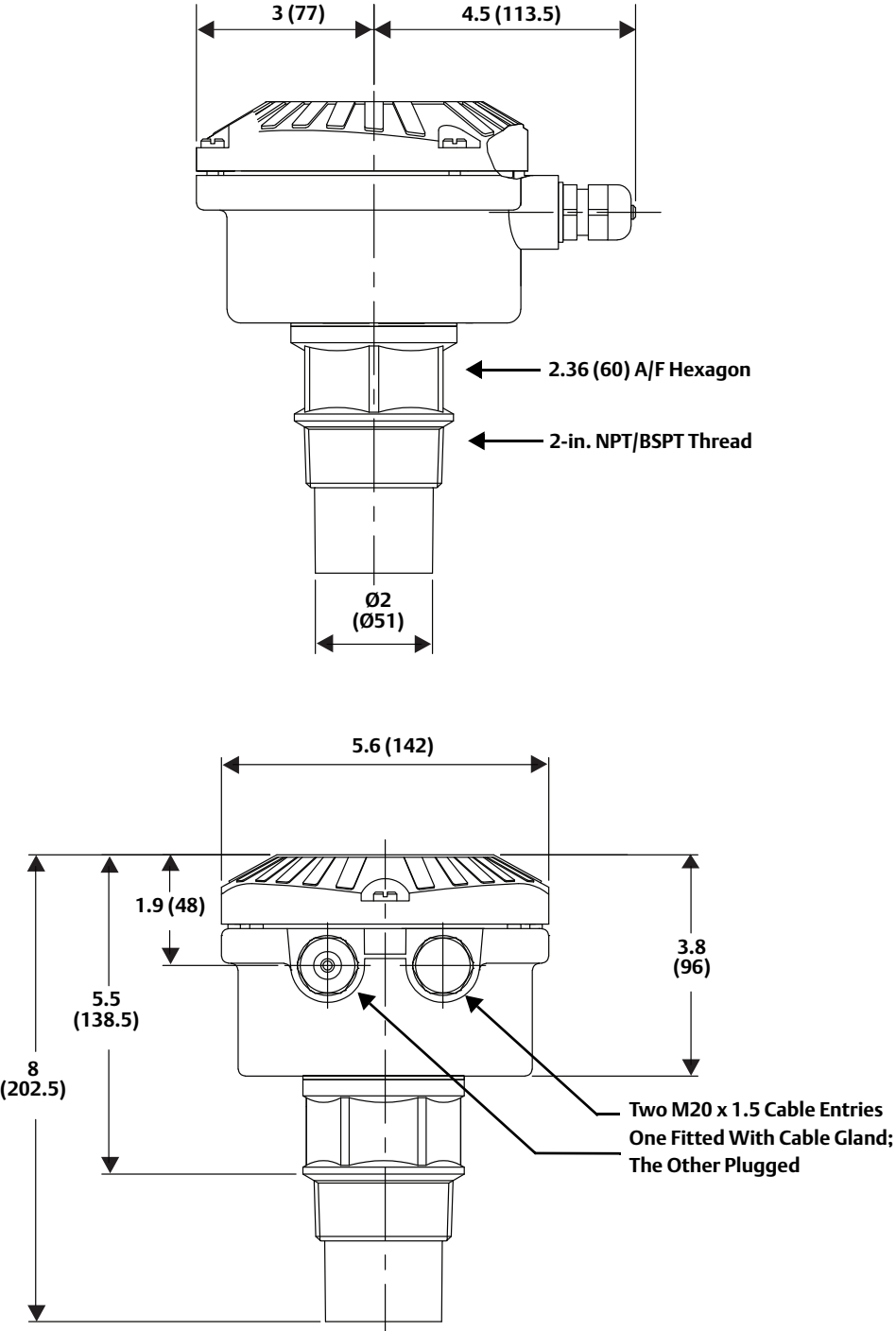

Note
Dimensions are in inches (mm).

Figure A-5. The 2-in. NPT/BSPT Mounting Bracket

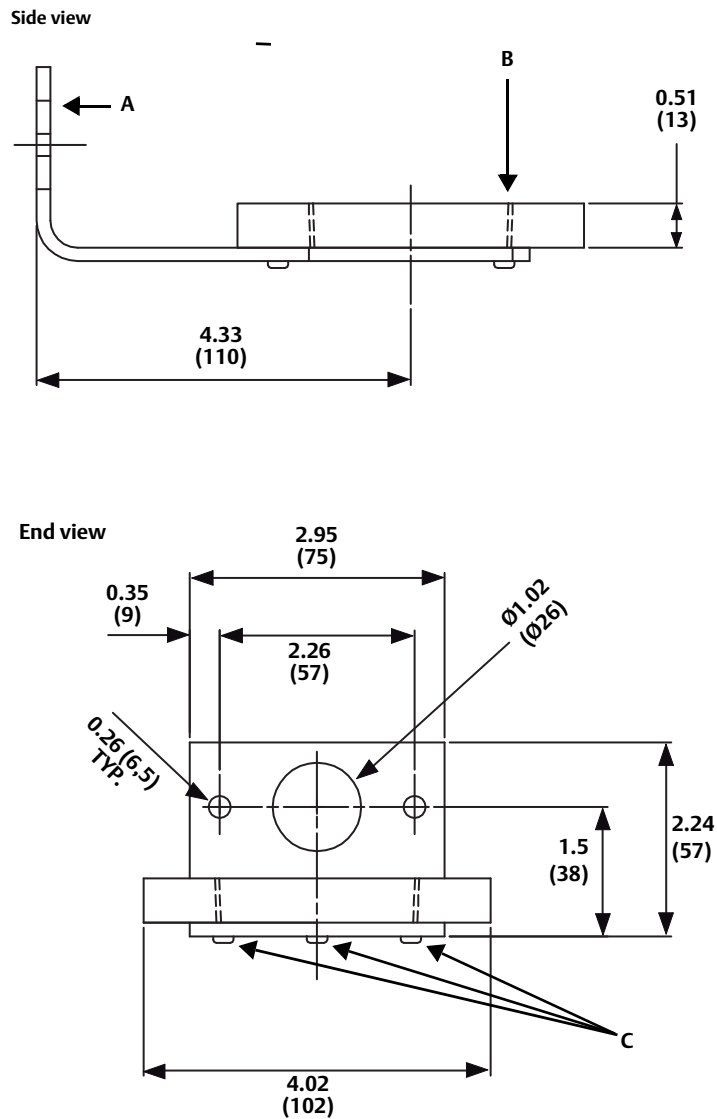

Actual views with transmitter mounted



- A. Stainless Steel Bracket
- B. 2-in. NPT/BSPT Threaded PVC Disc
- C. No. 4X 13 Long Self Tap Screw (3 Positions) Carbon Steel (Zinc Plated)

A.3 Ordering information

A.3.1 Rosemount 3101 ordering information

Table A-1. Rosemount 3101 ordering information

The starred options (★) represent the most common options and should be selected for best delivery. The non-starred offerings are subject to additional delivery lead time.

Model	Product description	
3101	Ultrasonic Level Transmitter, 1 to 26 ft. (0,3 to 8 m) range	
Signal output		
L	4–20 mA	★
Housing material		
A	Polyurethane-covered Aluminum	★
P	Glass Filled Nylon	★
Conduit / Cable thread		
1	½ –14 NPT	★
2	M20 x 1.5 adaptor	★
3	M20 x 1.5 supplied with nylon glands (Glass-filled Nylon Housing only)	★
Wetted material		
F	PVDF	★
Process connection		
RC ⁽¹⁾	2-in. NPT thread	★
SC ⁽²⁾	2-in. BSPT thread	★
Product certificates		
NA	No certification	★
G5	FM Ordinary Location	★
G6	CSA Ordinary Location	★

Options (include with selected model number)

Tag Plates		
ST ⁽³⁾	Stainless Steel engraved tag plate	★
WT	Laminated paper tag plate	★
Typical Model Number: 3101 L A 1 F RC G5 ST		

(1) Choosing this option implies US (Imperial) units of measurement in feet are required for the default configuration. The configuration can be changed on-site.

(2) Choosing this option implies Metric units of measurement in meters are required for the default configuration. The configuration can be changed on-site.

(3) The maximum number of characters that can be engraved is 16.

A.3.2 Rosemount 3102 ordering information

Table A-2. Rosemount 3102 ordering information

The starred options (★) represent the most common options and should be selected for best delivery. The non-starred offerings are subject to additional delivery lead time.

Model	Product description	
3102	Ultrasonic Level Transmitter with 2 integral relays, 1 to 36 ft. (0,3 to 11 m) range	
Signal output		
H	4–20 mA with HART communication	★
Housing material		
A	Polyurethane-covered Aluminum	★
P	Glass Filled Nylon	★
Conduit / Cable thread		
1	½ –14 NPT	★
2	M20 x 1.5 adaptor	★
3	M20 x 1.5 supplied with nylon glands (Glass-filled Nylon Housing only)	★
Wetted material		
F	PVDF	★
Process connection		
RC ⁽¹⁾	2-in. NPT thread	★
SC ⁽²⁾	2-in. BSPT thread	★
Product certificates		
NA	No certification	★
G5	FM Ordinary Location	★
G6	CSA Ordinary Location	★

Options (include with selected model number)

Special alarm options⁽³⁾		
C4	Namur NE43 alarm and saturation levels, high alarm	★
C5	Namur NE43 alarm and saturation levels, low alarm	★
C8	Standard Rosemount alarm and saturation levels, low alarm	★
Special certification option		
Q4	Certificate of functional test	★
Tag plates		
ST ⁽⁴⁾	Stainless Steel engraved tag plate	★
WT	Laminated paper tag plate	★
Typical model number: 3102 H A 1 F RC G5 C4 ST		

(1) Choosing this option implies US (Imperial) units of measurement in feet are required for the default configuration. Configuration can be changed on-site.

(2) Choosing this option implies Metric units of measurement in meters are required for the default configuration. Configuration can be changed on-site.

(3) When no Special Alarm option code is selected, the configuration is pre-set for a high-signal alarm indication, and standard Rosemount alarm and saturation levels (see “Electrical” on page 79 for details).

(4) The maximum number of characters that can be engraved is 16.

A.3.3 The Rosemount 3105 level transmitter

Table A-3. Rosemount 3105 ordering information

The starred options (★) represent the most common options and should be selected for best delivery. The non-starred offerings are subject to additional delivery lead time.

Model	Product description	
3105	Ultrasonic Level Transmitter for hazardous areas, 1 to 36 ft. (0,3 to 11 m) range	
Signal output		
H	4–20 mA with HART communication	★
Housing material		
A	Polyurethane-covered Aluminum	★
P	Glass Filled Nylon	★
Conduit / Cable thread		
1	½ – 14 NPT	★
2	M20 x 1.5 adaptor	★
3	M20 x 1.5 supplied with nylon glands (Glass-filled Nylon Housing only)	★
Wetted material		
F	PVDF	★
Process connection		
RC ⁽¹⁾	2-in. NPT thread	★
SC ⁽²⁾	2-in. BSPT thread	★
Product certificates		
I1	ATEX Intrinsically Safe	★
I3	NEPSI China Intrinsically Safe	★
I5	FM Intrinsically Safe and Non-Incendive	★
I6	CSA Intrinsically Safe and Non-Incendive	★
I7	IECEx Intrinsically Safe	★

Options (include with selected model number)

Special alarm options⁽³⁾		
C4	Namur NE43 alarm and saturation levels, high alarm	★
C5	Namur NE43 alarm and saturation levels, low alarm	★
C8	Standard Rosemount alarm and saturation levels, low alarm	★
Special certification option		
Q4	Certificate of functional test	★
Tag plates		
ST ⁽⁴⁾	Stainless Steel engraved tag plate	★
WT	Laminated paper tag plate	★
Typical model number: 3105 H A 1 F RC I5 ST		

(1) Choosing this option implies US (Imperial) units of measurement in feet are required for the default configuration. The configuration can be changed on-site.

(2) Choosing this option implies Metric units of measurement in meters are required for the default configuration. The configuration can be changed on-site.

(3) When no Special Alarm option code is selected, the configuration is pre-set for a high-signal alarm indication, and standard Rosemount alarm and saturation levels (see “Electrical” on page 79 for details).

(4) The maximum number of characters that can be engraved is 16.

A.4 Spare parts and accessories

A.4.1 Spare parts and accessories for the 3101/3102/3105

Table A-4. Spare Parts and Accessories

The starred options (★) represent the most common options and should be selected for best delivery. The non-starred offerings are subject to additional delivery lead time.

Spares and accessories		
03100-1001-0001	Flange Mounting, 2-in. NPT to 2-in. ASME B16.5 Class 150, PVC	★
03100-1001-0002	Flange Mounting, 2-in. NPT to 3-in. ASME B16.5 Class 150, PVC	★
03100-1001-0003	Flange Mounting, 2-in. NPT to 4-in. ASME B16.5 Class 150, PVC	★
03100-1001-0004	Flange Mounting, 2-in. NPT to 6-in. ASME B16.5 Class 150, PVC	★
03100-1002-0001	Flange Mounting, 2-in. BSPT to PN16 DN50, PVC	★
03100-1002-0003	Flange Mounting, 2-in. BSPT to PN16 DN80, PVC	★
03100-1002-0004	Flange Mounting, 2-in. BSPT to PN16 DN100, PVC	★
03100-1002-0005	Flange Mounting, 2-in. BSPT to PN16 DN150, PVC	★
03100-1003-0001 ⁽¹⁾	2-in. NPT Mounting Bracket	★
03100-1003-0002 ⁽¹⁾	2-in. BSPT Mounting Bracket	★
03100-0001-0001	Remote Temperature Sensor (Rosemount 3102 and Rosemount 3105 only)	★
03100-0002-0002	1/2-14 NPT to M20 x 1.5 Conduit Adaptor (Pack of two)	★

(1) See Figure A-5 on page A-86 for dimensions.

Figure A-6. Remote Temperature Sensor

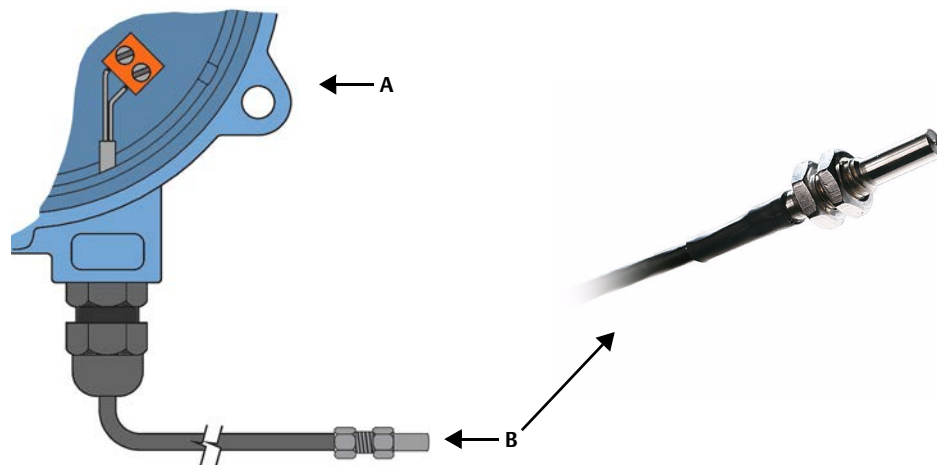

A. Rosemount 3102/3105 Transmitter

B. Remote Temperature Sensor option (for the 3102 and 3105)

Appendix B Product Certifications

Manufacturing location	page 91
European Union directive information	page 91
Non-hazardous location certifications	page 92
Hazardous locations certifications	page 93
Approval drawings	page 97

B.1 Manufacturing location

Rosemount Measurement Limited
– Slough, Berkshire, United Kingdom

B.2 European Union directive information

Note

The EC declaration of conformity for all applicable European directives for this product can be found on the Rosemount web site at www.rosemount.com. A hard copy may be obtained by contacting our local sales representative.

ATEX directive (94/9/EC)

- Emerson Process Management complies with the ATEX directive.

Pressure equipment directive (PED) (97/23/EC)

- The 3101, 3102, and 3105 are outside the scope of the PED directive.

Electro magnetic compatibility (EMC) (2004/108/EC)

- EN 61326-1:2006

B.3 Non-hazardous location certifications

Note

Refer to the housing label to identify the approvals for your transmitter.

B.3.1 American and Canadian certifications

Factory Mutual (FM) ordinary location certification (on the 3101 and 3102 only)

G5 Project ID: 3024095

The transmitter has been examined and tested to determine that the design meets basic electrical, mechanical, and fire protection requirements by FM, a nationally recognized testing laboratory (NRTL) as accredited by the Federal Occupational Safety and Health Administration (OSHA).

Canadian Standards Association (CSA) ordinary location certification (on the 3101 and 3102 only)

G6 Project ID: 02 CSA 1871624

The transmitter has been examined and tested to determine that the design meets basic electrical, mechanical, and fire protection requirements by CSA, a nationally recognized testing laboratory as accredited by the Standards Council of Canada (SCC).

Special condition for safe use:

1. For this CSA approval, power for the 3101 and 3102 must be supplied from a Rosemount 3490 Series Control Unit or a class 2 separate extra-low voltage (SELV) source.

B.4 Hazardous locations certifications

WARNING

Potential electrostatic charging hazard: to prevent the risk of electrostatic sparking, the surface of the glass-filled nylon (plastic) enclosure should only be cleaned with a damp cloth. Do not directly install in any process where its enclosure might be charged by the rapid flow of non-conductive media.

The aluminum alloy (metal) enclosure presents a risk of ignition due to impact and shall be taken into consideration during installation and use.

Refer to the housing label to identify the approvals for your transmitter.

B.4.1 American and Canadian certifications

Factory Mutual (FM) intrinsically safe and non-incendive approvals (on the 3105 only)

- 15 Project ID: 3024095
Intrinsically Safe for Class I, Division 1, Groups A, B, C, and D
Zone Marking: Class I, Zone 0, AEx ia IIC
Non-incendive for Class I, Division 2, Groups A, B, C and D
Zone Marking: Class I, Zone 2, AEx nA IIC
Temperature Code: T6 ($T_a = 55\text{ }^\circ\text{C}$)
Temperature Code: T4 ($T_a = 60\text{ }^\circ\text{C}$)
Control Drawing: 71097/1216 (See [Figure B-1 on page 98](#))
 $U_i = 30\text{ V}$, $I_i = 120\text{ mA}$, $P_i = 0.82\text{ W}$, $L_i = 108\text{ }\mu\text{H}$, $C_i = 0\text{ }\mu\text{F}$

Canadian Standards Association (CSA) intrinsically safe and non-incendive approvals (on the 3105 only)

- 16 Project ID: 02 CSA 1352094
Intrinsically Safe for Class I, Division 1, Groups A, B, C, and D.
Zone Marking: Class I, Zone 0, Ex ia IIC
Non-incendive for Class I, Division 2, Groups A, B, C and D.
Zone Marking: Class I, Zone 2, Ex nL IIC
Temperature Code: T4 ($T_a = -40\text{ to }60\text{ }^\circ\text{C}$)
Temperature Code: T6 ($T_a = -40\text{ to }55\text{ }^\circ\text{C}$)
Control Drawing: 71097/1218 (See [Figure B-2 on page 99](#))
 $U_i = 30\text{ V}$, $I_i = 120\text{ mA}$, $P_i = 0.82\text{ W}$, $L_i = 108\text{ }\mu\text{H}$, $C_i = 0\text{ }\mu\text{F}$

B.4.2 European certification

ATEX intrinsically safe approval (on the 3105 only)

- 11 Certificate: Sira 06ATEX2260X
ATEX Intrinsic Safety
II 1 G, Ex ia IIC T6 Ga ($T_a = -40\text{ to }55\text{ }^\circ\text{C}$), Ex ia IIC T4 Ga ($T_a = -40\text{ to }60\text{ }^\circ\text{C}$)
 $U_i = 30\text{ V}$, $I_i = 120\text{ mA}$, $P_i = 0.82\text{ W}$, $L_i = 108\text{ }\mu\text{H}$, $C_i = 0\text{ }\mu\text{F}$
(see “Instructions specific to hazardous area installations (I1 and I7)” on page 95)

B.4.3 International certifications

NEPSI China intrinsically safe approval (on the 3105 only)

- 13 Certificate: GYJ081008X
NEPSI Intrinsic Safety
Ex ia IIC T6 ($T_a = -40$ to 55 °C)
Ex ia IIC T4 ($T_a = -40$ to 60 °C)
 $U_i = 30$ V, $I_i = 120$ mA, $P_i = 0.82$ W, $L_i = 108$ μ H, $C_i = 0$ μ F
(see “Instructions specific to hazardous area installations (13)” on page 96)

IECEx intrinsically safe approval (on the 3105 only)

- 17 Certificate: IECEx SIR 06.0068X
IECEx Intrinsic Safety
Zone 0, Ex ia IIC T6 Ga ($T_a = -40$ to 55 °C)
Zone 0, Ex ia IIC T4 Ga ($T_a = -40$ to 60 °C)
 $U_i = 30$ V, $I_i = 120$ mA, $P_i = 0.82$ W, $L_i = 108$ μ H, $C_i = 0$ μ F
(see “Instructions specific to hazardous area installations (11 and 17)” on page 95)

Instructions specific to hazardous area installations (I1 and I7)

Model numbers covered: 3105*****11**** and 3105*****I7****
(* indicates options in construction, function and materials).

The following instructions apply to equipment covered by certificates numbered SIRA 06ATEX2260X and IECEx SIR 06.0068X:

1. The equipment may be used with flammable gases and vapors with apparatus groups IIA, IIB, and IIC, and with temperature classes T1, T2, T3, T4, T5, and T6.
2. Installation of this equipment shall be carried out by suitably trained personnel, in accordance with the applicable code of practice.
3. The equipment is not intended to be repaired by the user and is to be replaced by an equivalent certified unit. Repairs should only be carried out by the manufacturer or approved repairer.
4. If the equipment is likely to come into contact with *aggressive substances*, it is the responsibility of the user to take *suitable precautions* that prevent it from being adversely affected, thus ensuring that the type of protection is not compromised.

Aggressive Substances e.g. acidic liquids or gases that may attack metals or solvents that may affect polymeric materials.

Suitable Precautions e.g. regular checks as part of routine inspections or establishing from the material's data sheet that it is resistant to specific chemicals.

The metallic alloy used for the enclosure material may be accessible at the surface of this equipment. In the event of rare accidents, ignition sources due to impact and friction spark could occur. This shall be considered when the 3105 is being installed in locations that specifically require Equipment Protection Level Ga (IECEx: zone 0) (ATEX: group II, category 1G) equipment.
5. The apparatus electronics is only certified for use in ambient temperatures in the range of -40 to 60 °C for T4 or -40 to 55 °C for T6. It should not be used outside this range.
6. It is the responsibility of the user to ensure:
 - a. The voltage and current limits for this equipment are not exceeded.
 - b. That only suitably certified cable entry devices will be utilized when connecting this equipment.
 - c. That any unused cable entries are sealed with suitably certified stopping plugs.
7. The Rosemount 3105 meets the requirements of clause 6.3.12 (isolation of circuits from earth or frame) in IEC 60079-11:2006 (EN 60079-11:2007).
8. Technical Data:
 - a. Materials of construction:
Probe: PVDF
Housing and cover: glass-filled nylon, stainless steel, or aluminum alloy
Cover seal: Silicone
Nylon cable glands and blanking plugs

- b. Coding:
 - ATEX:
 - II 1 G,
 - Ex ia IIC T4 Ga ($T_a = -40$ to $60\text{ }^\circ\text{C}$)
 - Ex ia IIC T6 Ga ($T_a = -40$ to $55\text{ }^\circ\text{C}$)
 - IECEX:
 - Zone 0
 - Ex ia IIC T4 Ga ($T_a = -40$ to $60\text{ }^\circ\text{C}$)
 - Ex ia IIC T6 Ga ($T_a = -40$ to $55\text{ }^\circ\text{C}$)
- c. Electrical: $U_i = 30\text{ V}$, $I_i = 120\text{ mA}$, $P_i = 0.82\text{ W}$, $L_i = 108\text{ }\mu\text{H}$, $C_i = 0\text{ }\mu\text{F}$
- 9. Special conditions for safe use:
 - a. The equipment must not be installed directly in any process where the enclosure might be charged by the rapid flow of non-conductive media.
 - b. The equipment must only be cleaned with a damp cloth.
- 10. Manufacturer: Mobrey Limited, 158 Edinburgh Avenue, Slough, Berkshire, SL1 4UE, UK

Instructions specific to hazardous area installations (I3)

The 3105 transmitter, manufactured by Mobrey Limited, has been certified by the National Supervision and Inspection Center for Explosion Protection and Safety of Instrumentation (NEPSI). The 3105 transmitter accords with GB 3836.1-2000 and GB 3836.4-2000 standards.

Ex marking: Ex ia IIC T4/T6

Certificate: GYJ081008X

Special conditions for safe use:

1. The "X" in the certificate number denotes a specific condition of use:
 - a. To avoid the danger of an electrostatic charge in a hazardous area installation, the plastic parts of the transmitter shall only be cleaned with a damp cloth.
2. The relationship between temperature class, ambient temperature range, and process temperature range is as follows:
 - b. 3105*****:

Temperature Class	Ambient Temperature	Process Temperature
T4	-40 to $60\text{ }^\circ\text{C}$	$\leq 130\text{ }^\circ\text{C}$
T6	-40 to $55\text{ }^\circ\text{C}$	$\leq 80\text{ }^\circ\text{C}$

3. Safety parameters:
 - Power supply terminals (1, 2): $U_i:30\text{ V}$, $I_i:120\text{ mA}$, $P_i:0.82\text{ W}$, $C_i:0\text{ nF}$, $L_i:108\text{ }\mu\text{H}$
 - Sensor terminals (7, 8): $U_o:30\text{ V}$, $I_o:8.42\text{ mA}$, $P_o:63\text{ mW}$, $C_o:66\text{ nF}$, $L_o:502\text{ mH}$
4. The cable entries of the 3105 transmitter should be sealed and protected by cable glands/blanking plugs that have a minimum rating of IP 20 (GB 4208-1993).
5. Associated apparatus should be installed in a safe location. During installation, operation, and maintenance, the instruction manual should be strictly observed.

6. End users are not permitted to change any components inside.
(See “[Service support](#)” on page 2 for contact information)
7. During installation, use, and maintenance of the 3105 transmitter, the following standards are to be observed:
 - a. GB3836.13-1997
“Electrical apparatus for explosive gas atmosphere Part 13: Repair and overhaul for apparatus used in explosive gas atmosphere”.
 - b. GB3836.15-2000
“Electrical apparatus for explosive gas atmosphere Part 15: Electrical installations in hazardous area (other than mines)”.
 - c. GB3836.16-2006
“Electrical apparatus for explosive gas atmosphere Part 16: Inspection and maintenance of electrical installation (other than mines)”.
 - d. GB50257-1996
“Code for construction and acceptance of electric device for explosion atmospheres and fire hazard electrical equipment installation engineering”.

B.5 Approval drawings

This section contains Factory Mutual installation drawings and Canadian Standards installation drawings. You must follow the installation guidelines presented in order to maintain certified ratings for installed transmitters.

This section contains the following drawings:

Rosemount Drawing 71097/1216, Issue 2:

System Control Drawing for hazardous location installation of intrinsically safe FM approved apparatus.

Rosemount Drawing 71097/1218, Issue 2:

System Control Drawing for hazardous location installation of intrinsically safe CSA approved apparatus.

Figure B-2. System Control Drawing for Hazardous Location Installation of Intrinsically Safe and Non-incendive CSA Approved Apparatus

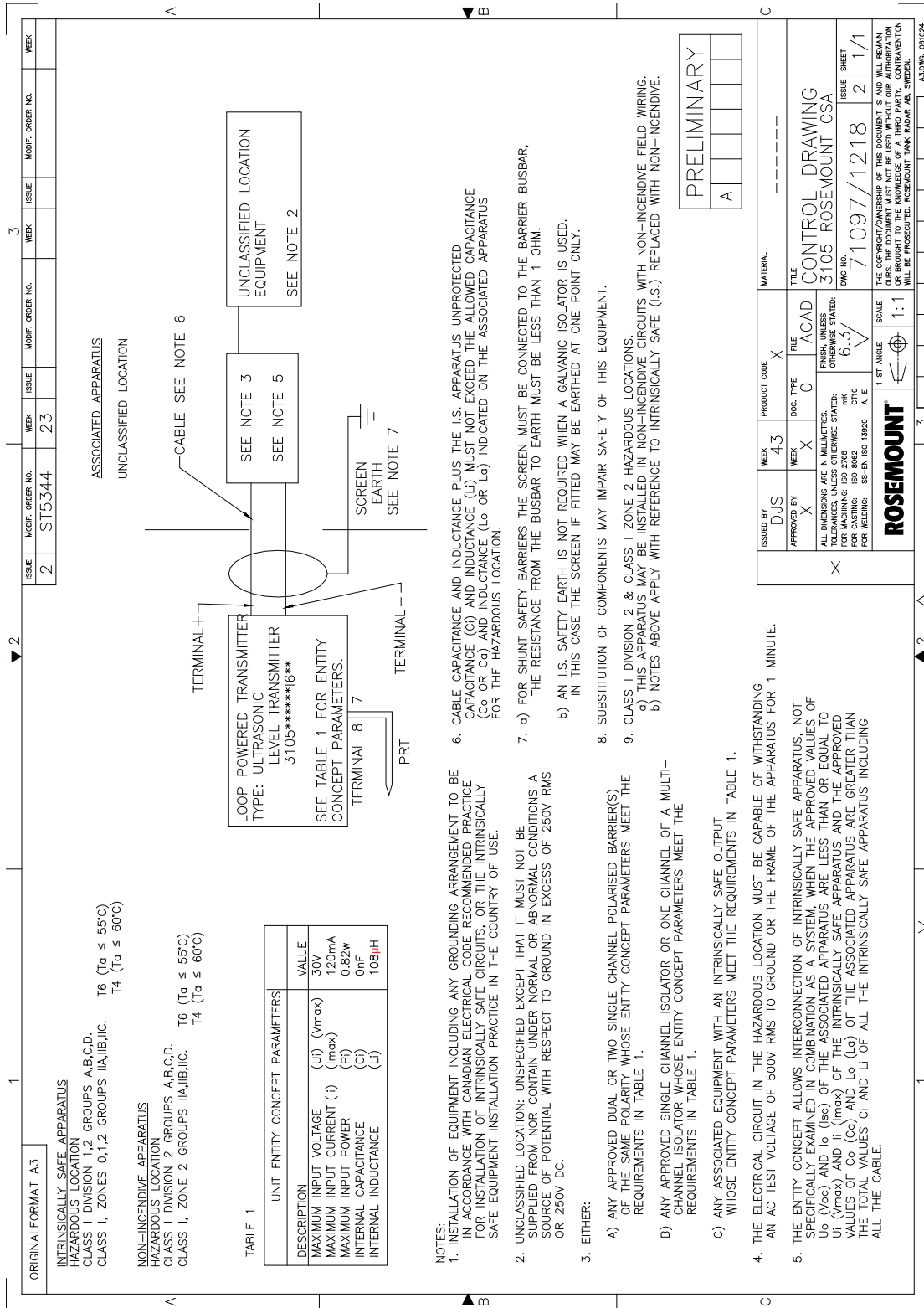

Appendix C Integrated Display Menus

Menus on the 3101	page 102
Menus on the 3102 and the 3105	page 103

C.1 Menus on the 3101

Figure C-1. Menu Programming on the 3101

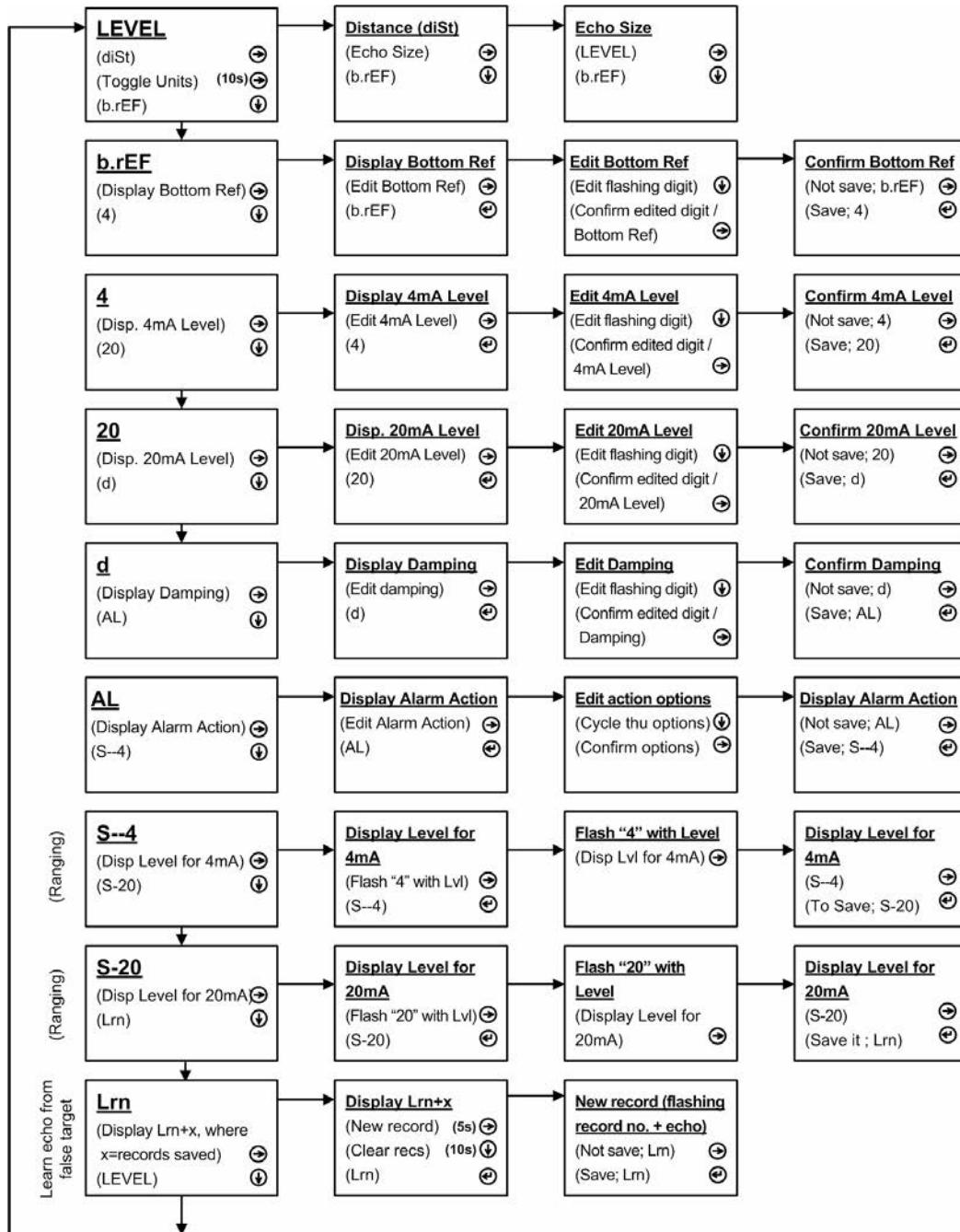

C.2 Menus on the 3102 and the 3105

Figure C-2. Main Menu Programming on the 3102/3105 (Part One)

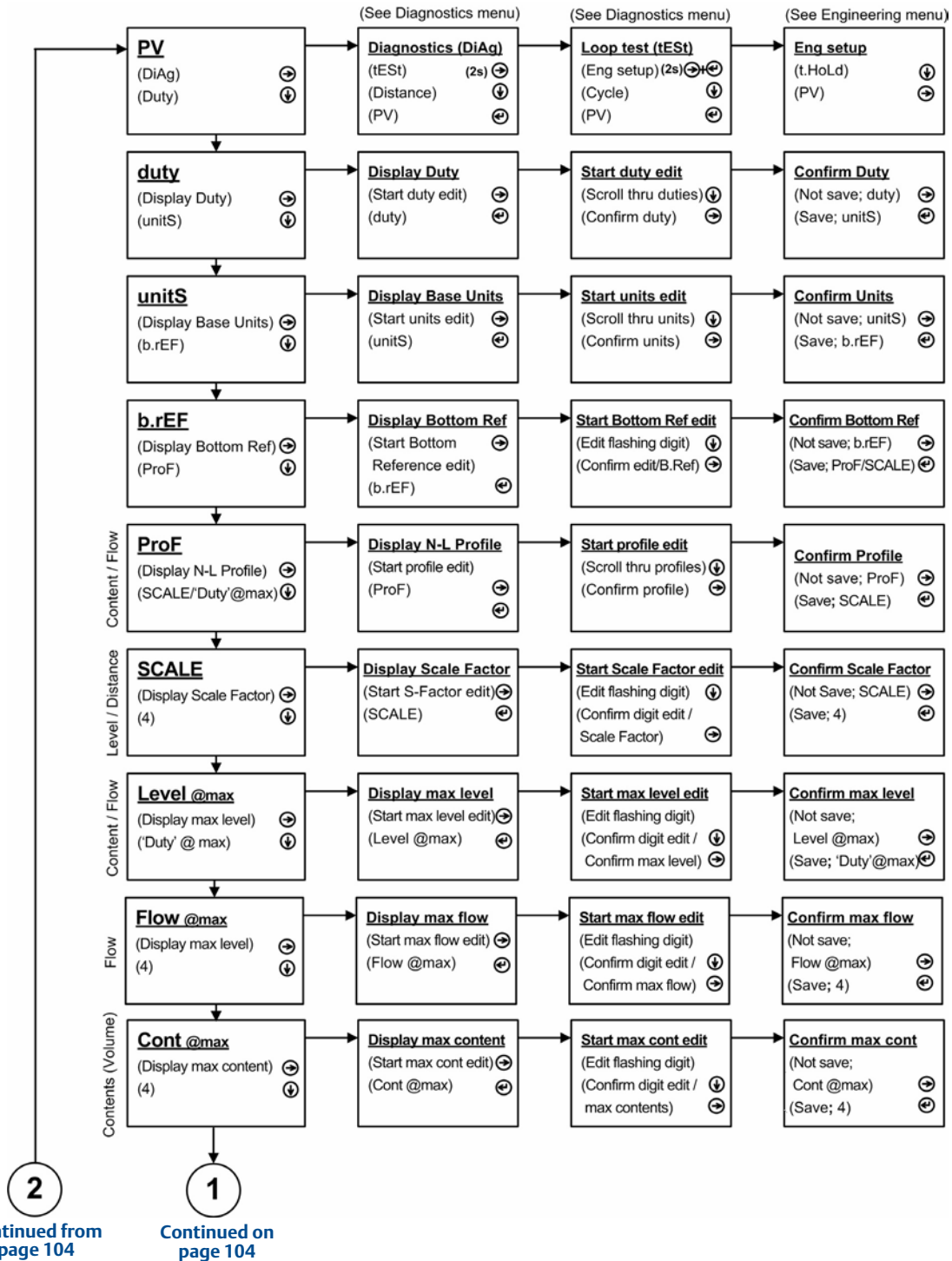

Figure C-3. Main Menu Programming on the 3102/3105 (Part Two)

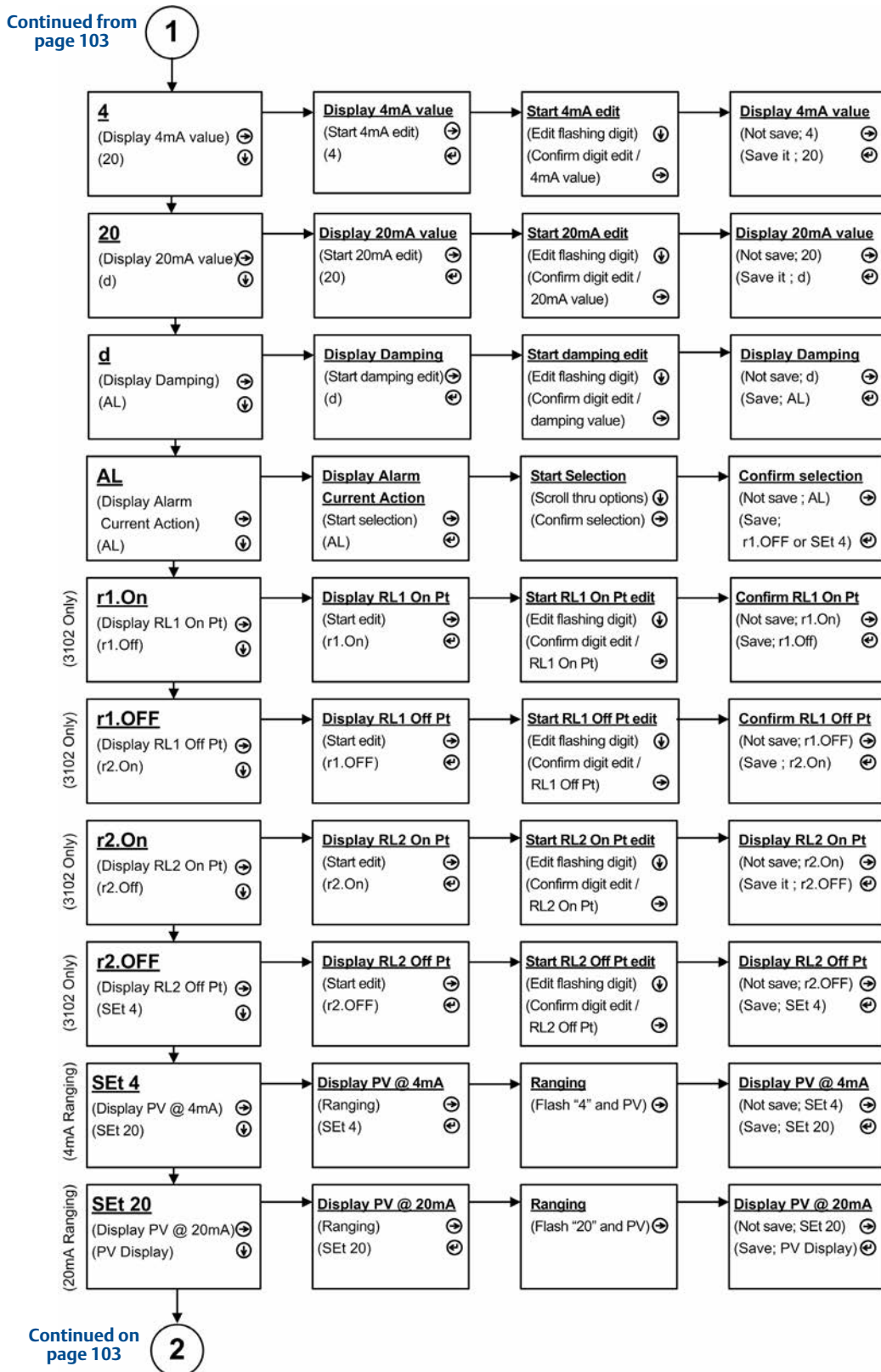

Figure C-4. Diagnostics Menu on the 3102/3105

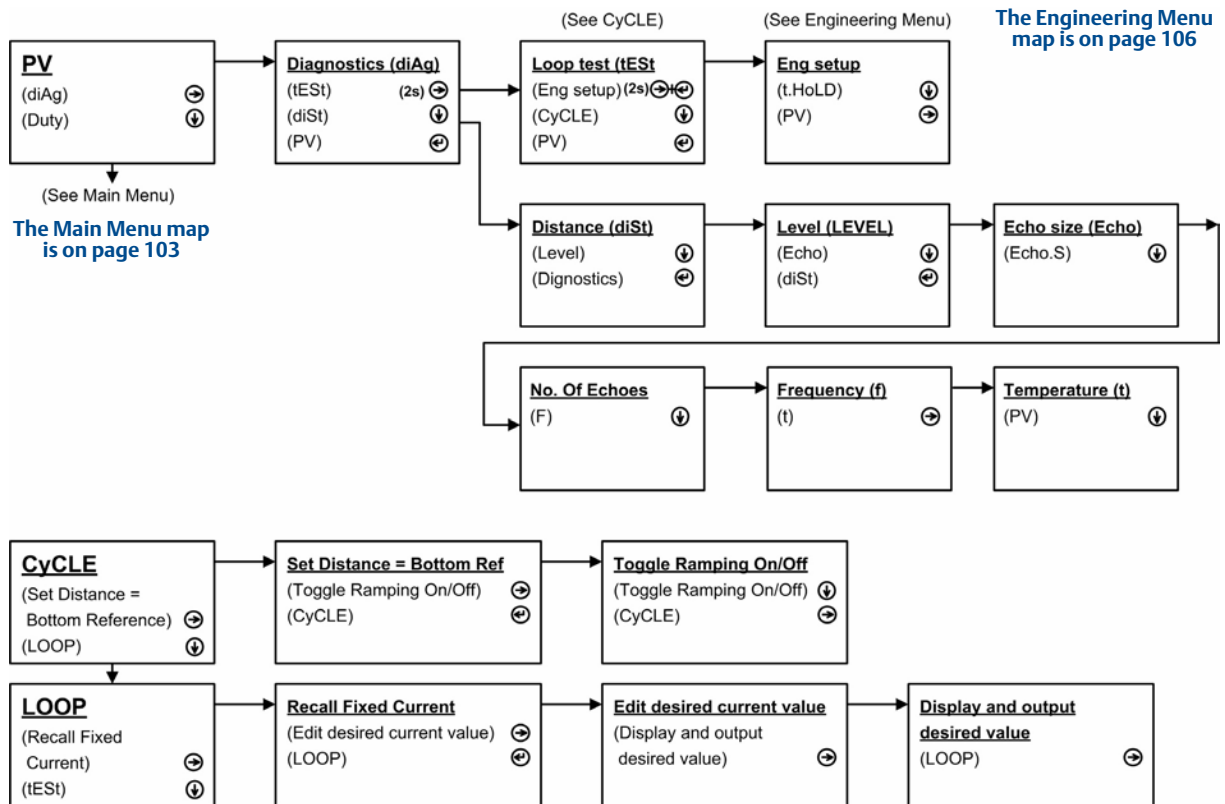

Figure C-5. Engineering Menu on the 3102/3105 (Part One)

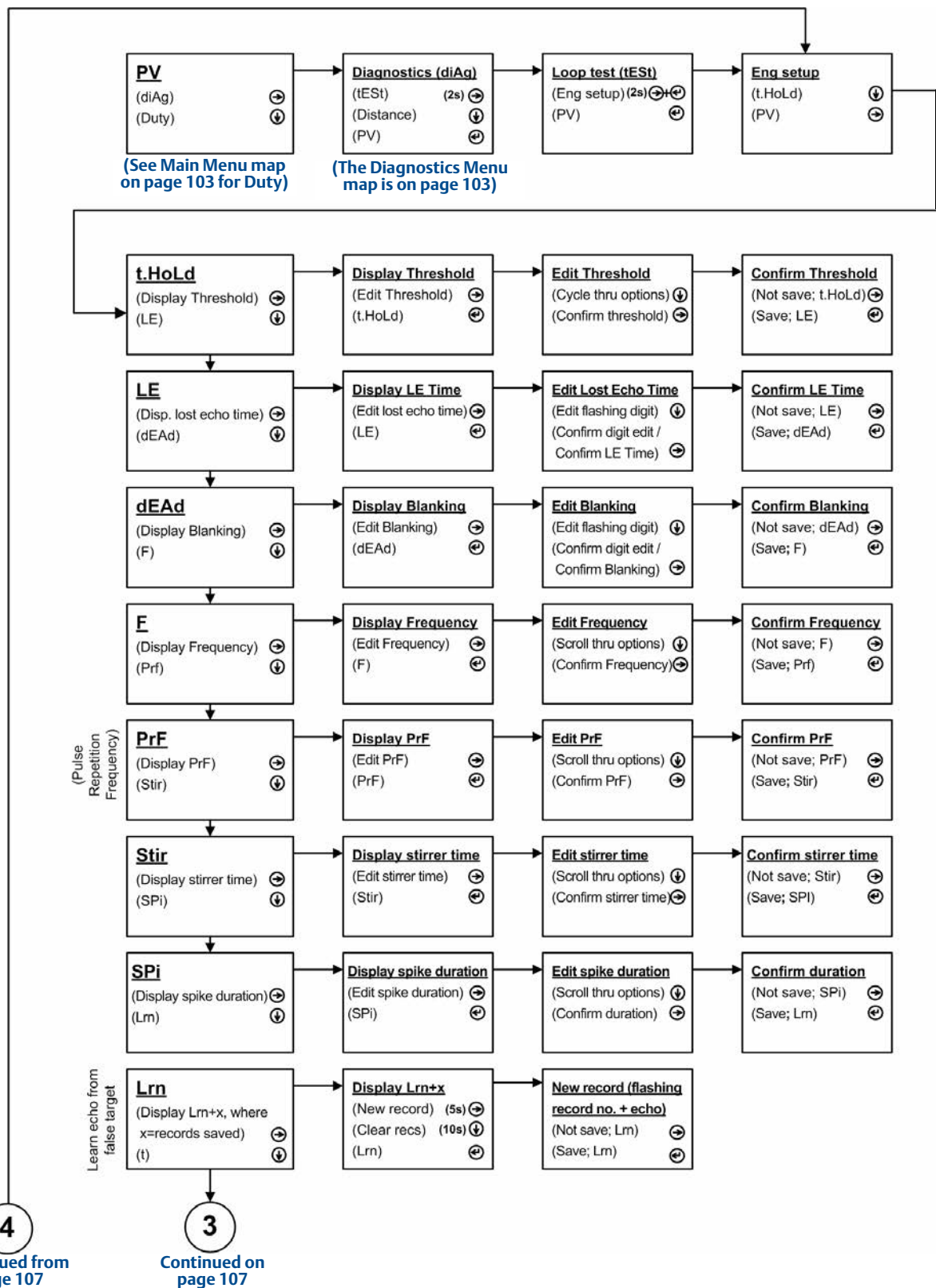
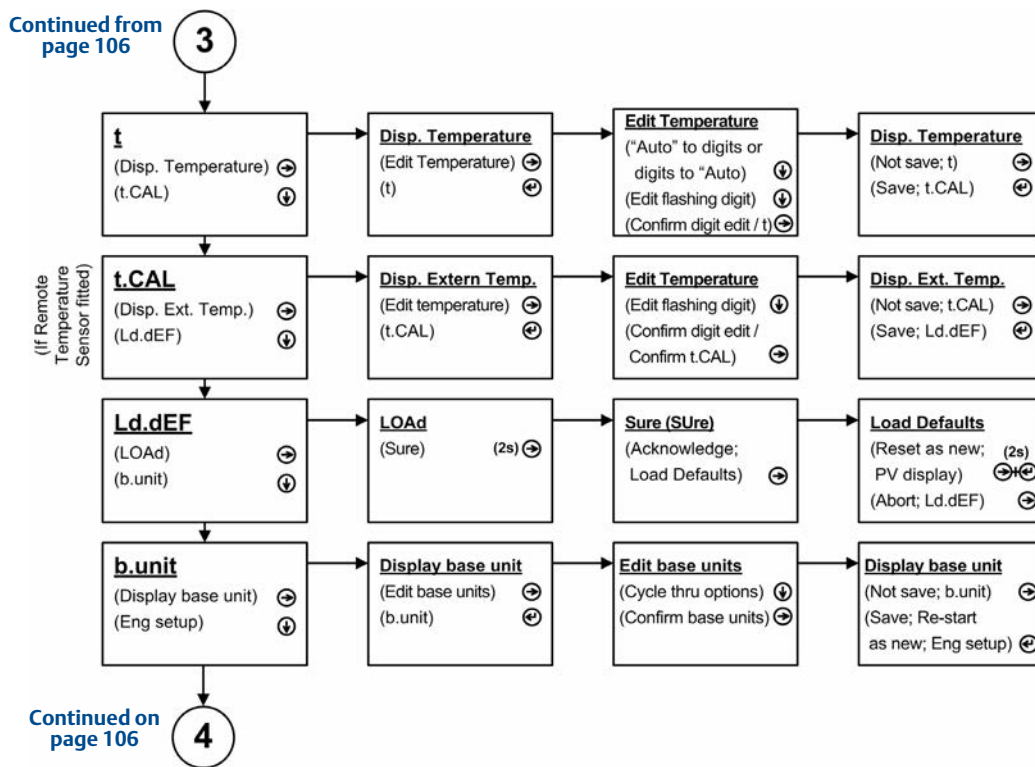

Figure C-6. Engineering Menu on the 3102/3105 (Part Two)



Appendix D Rosemount 3490 Series Menus

Introduction	page 109
Rosemount 3100 Series Transmitter (3102/3105)	page 110

D.1 Introduction

The Rosemount 3102 and Rosemount 3105 can be used with the Rosemount 3490 Series Control Unit. This control unit supplies the 24 Vdc loop-power to the transmitter, and provides control functionality using the 4–20 mA signal from the transmitter. The control unit has HART communications capability, and access to all of the parameters of the transmitter as shown in the following pages.

Note

The Rosemount 3490 Series reference manual (Document Number 00809-0100-4841) provides detailed instructions on the use and features of the control unit.

D.2 Menus and parameters

See Table D-1 on page 110.

Table D-1. Rosemount 3100 Series Transmitter (3102/3105)

Level 1	Level 2	Level 3	Level 4	Parameter ID and Descriptor	3102			3105					
					m	ft.	in.	m	ft.	in.			
SETUP ⁽¹⁾	DUTY			P010	Bottom Reference (page 136)	11.0	36.0	432.0	11.0	36.0	432.0		
					Present Depth (page 121)	-	-	-	-	-	-		
					SET AS EMPTY (page 120)	-	-	-	-	-	-		
				P011	Tank Shape (page 143)	Linear			Linear				
				P060	Distance Offset (page 141)	0.0	0.0	0.0	0.0	0.0	0.0		
				P069	Level Offset (page 142)	0.0	0.0	0.0	0.0	0.0	0.0		
				P013	PV Scale Factor (page 154)	1.0	1.0	1.0	1.0	1.0	1.0		
				P014	Profile Height (page 156)	1.0	1.0	1.0	1.0	1.0	1.0		
				NLP CURVE	P030	Profile Point 1 (page 158)	10	10	10	10	10	10	
					P031	Profile Point 2 (page 158)	20	20	20	20	20	20	
		P032	Profile Point 3 (page 158)		30	30	30	30	30	30			
		P033	Profile Point 4 (page 158)		40	40	40	40	40	40			
		P034	Profile Point 5 (page 158)		50	50	50	50	50	50			
		P035	Profile Point 6 (page 158)		60	60	60	60	60	60			
		P036	Profile Point 7 (page 158)		70	70	70	70	70	70			
		P037	Profile Point 8 (page 158)		80	80	80	80	80	80			
		P038	Profile Point 9 (page 158)		90	90	90	90	90	90			
		P039	Profile Point 10 (page 158)		100	100	100	100	100	100			
		IDENTITY	P000	Message (page 131)	MESSAGE			MESSAGE					
			P001	Tag (page 132)	3102			3105					
	P002		Description (page 133)	3102 XMTR			3105 XMTR						
	UNITS			P012	PV Units (page 153)	m	ft	in	m	ft	in		
	OUTPUT	CURRENT			P015	Upper Range Value (page 159)	10.7	34.5	414.0	10.7	34.5	414.0	
					P016	Lower Range Value (page 160)	0.0	0.0	0.0	0.0	0.0	0.0	
					P020	Damping (page 162)	3.0	3.0	3.0	3.0	3.0	3.0	
		RELAYS ⁽²⁾	RELAY 1			P070	Relay 1 mode (page 163)	Setpoint			-	-	-
						P071	Relay 1 PV On Point (page 165)	0.0	0.0	0.0	-	-	-
						P072	Relay 1 PV Off Point (page 166)	0.0	0.0	0.0	-	-	-
			RELAY 2				P073	Relay 2 mode (page 167)	Fault			-	-
	P074	Relay 2 PV On Point (page 168)					0.0	0.0	0.0	-	-	-	
	P075	Relay 2 PV Off Point (page 169)	0.0	0.0	0.0	-	-	-					
	ENGINEERING				P021	LE Delay (page 170)	900	900	900	900	900	900	
					P022	LE Action (page 172)	Hold	Hold	Hold	Hold	Hold	Hold	
P023					Upper Blanking (page 138)	0.3	1.0	12	0.3	1.0	12		
P063					Lower Blanking (page 140)	0.0	0.0	0.0	0.0	0.0	0.0		
P024					Speed of Sound (page 174)	331.8	1088.6	13063	331.8	1088.6	13063		
P025					Temperature (page 176)	Auto	Auto	Auto	Auto	Auto	Auto		
P026					Set Threshold (page 177)	Auto	Auto	Auto	Auto	Auto	Auto		

Level 1	Level 2	Level 3	Level 4	Parameter ID and Descriptor			3102			3105		
							m	ft.	in.	m	ft.	in.
		ADVANCED		P040	Tx Pwr Control (page 178)	Enabled			Enabled			
				P041	Pulse Repeat (page 179)	1.0	1.0	1.0	1.0	1.0	1.0	
				P042	Echoes Needed (page 180)	4	4	4	4	4	4	
				P043	Threshold 1 Time (page 181)	2.9	2.9	2.9	2.9	2.9	2.9	
				P044	Target Pulses (page 183)	Auto	Auto	Auto	Auto	Auto	Auto	
				P045	Target frequency (page 184)	Auto	Auto	Auto	Auto	Auto	Auto	
				P048	Threshold 1 Size (page 182)	6.0	6.0	6.0	6.0	6.0	6.0	
				P049	Spike Rejection (page 185)	0	0	0	0	0	0	
			FALSE ECHO DATA	P081	False Echo D 1 (page 186)	0.0	0.0	0.0	0.0	0.0	0.0	
				P082	False Echo S 1 (page 186)	0.0	0.0	0.0	0.0	0.0	0.0	
				P083	False Echo D 2 (page 186)	0.0	0.0	0.0	0.0	0.0	0.0	
				P084	False Echo S 2 (page 186)	0.0	0.0	0.0	0.0	0.0	0.0	
				P085	False Echo D 3 (page 186)	0.0	0.0	0.0	0.0	0.0	0.0	
				P086	False Echo S 3 (page 186)	0.0	0.0	0.0	0.0	0.0	0.0	
				P087	False Echo D 4 (page 186)	0.0	0.0	0.0	0.0	0.0	0.0	
				P088	False Echo S 4 (page 186)	0.0	0.0	0.0	0.0	0.0	0.0	
				D980	No. of false echoes stored	-	-	-	-	-	-	
			FALSE ECHO ACTION	P089	Clear False Echoes (page 187)	-	-	-	-	-	-	
					LEARN FALSE ECHO (page 122)	-	-	-	-	-	-	
					AUTO TANK MAP (page 124)	-	-	-	-	-	-	
			SYSTEM		SIMULATION (page 125)	-	-	-	-	-	-	
				TRIM		FIX CURRENT (page 128)	-	-	-	-	-	-
						TRIM 4 mA (page 129)	-	-	-	-	-	-
						TRIM 20 mA (page 129)	-	-	-	-	-	-
						RESTART DEVICE (page 126)	-	-	-	-	-	-
						LOAD DEFAULTS (page 127)	-	-	-	-	-	-
						FACTORY USE	-	-	-	-	-	-
						Base Units (page 118)	-	-	-	-	-	-
		FIXED			P004	Final Assy No. (page 134)	(Factory Set)			(Factory Set)		
					P005	Serial Number (page 135)	(Factory Set)			(Factory Set)		
					P970	Transducer Material (page 188)	PVDF			PVDF		
				HART	D949	Model Code (page 209)	52 (=3102)			53 (=3105)		
			D951		Poll Address (page 189)	0			0			
			D952		Hardware Revision (page 210)	(Factory Set)			(Factory Set)			
			D953		Software Revision (page 211)	(Factory Set)			(Factory Set)			
			D960		Manufacturer (page 212)	Rosemount			Rosemount			
			D961		Unique ID (page 213)	(Factory Set)			(Factory Set)			
			D962		HART Revision (page 214)	5	5	5	5	5	5	
			D963		Field Device Rev. (page 215)	(Factory Set)			(Factory Set)			
			D964		Request Preambles (page 216)	5	5	5	5	5	5	
		D965	Flags (page 217)		-	-	-	-	-	-		

Level 1	Level 2	Level 3	Level 4	Parameter ID and Descriptor	3102			3105					
					m	ft.	in.	m	ft.	in.			
MONITOR ⁽¹⁾	READINGS	VARIABLES		D900	Primary Variable (page 193)	-	-	-	-	-	-		
				D901	Level (SV) (page 194)	-	-	-	-	-	-		
				D902	Distance (TV) (page 195)	-	-	-	-	-	-		
				D903	Temperature (page 196)	-	-	-	-	-	-		
		CURRENT		D906	Current Output (page 198)	-	-	-	-	-	-		
				D905	% Current Output (page 197)	-	-	-	-	-	-		
				D908	Relay Status ⁽²⁾	-	-	-	-	-	-		
		DIAGNOSTICS				D910	Distance (page 199)	-	-	-	-	-	-
						D911	Echo Size (page 200)	-	-	-	-	-	-
					D912	Echo Success (page 201)	-	-	-	-	-	-	
					D913	Target Echoes (page 202)	-	-	-	-	-	-	
					D914	Speed Of Sound (page 203)	-	-	-	-	-	-	
					D915	Temperature SoS calc (page 204)	-	-	-	-	-	-	
	OPERATION					D916	Frequency (page 205)	-	-	-	-	-	-
						D917	Threshold in Use (page 206)	-	-	-	-	-	-
						D918	Pulses In Use (page 207)	-	-	-	-	-	-
						D919	Transmit Power (page 208)	-	-	-	-	-	-
	HISTORY					P003	Date (page 192)	-	-	-	-	-	-
						P046	Max Temperature (page 190)	-	-	-	-	-	-
						P047	Min Temperature (page 191)	-	-	-	-	-	-
	STATUS ⁽³⁾					D991	Device Status Group 1	-	-	-	-	-	-
						D992	Device Status Group 2	-	-	-	-	-	-
						D993	Device Status Group 3	-	-	-	-	-	-
						D994	Device Status Group 4	-	-	-	-	-	-
						D995	Device Status Group 5	-	-	-	-	-	-
					D996	Device Status Group 6	-	-	-	-	-	-	

(1) Selecting this menu presents a SELECT INSTRUMENT screen if a HART transmitter is assigned to a Current Input channel. Select TRANSMITTER tag to see Menu Level 1 options.

(2) Available on the 3102 only.

(3) These parameters are used by AMS Device Manager.

Appendix E Field Communicator Menus

Introduction	page 113
Menus and parameters	page 113

E.1 Introduction

The Rosemount 3102 and Rosemount 3105 support HART communications, which may be used to program or interrogate the transmitter from any point on the two-wire loop. This appendix contains the full menu structure.

E.2 Menus and parameters

See Figure E-1 on page 114.

Figure E-1. Field Communicator Menu Tree

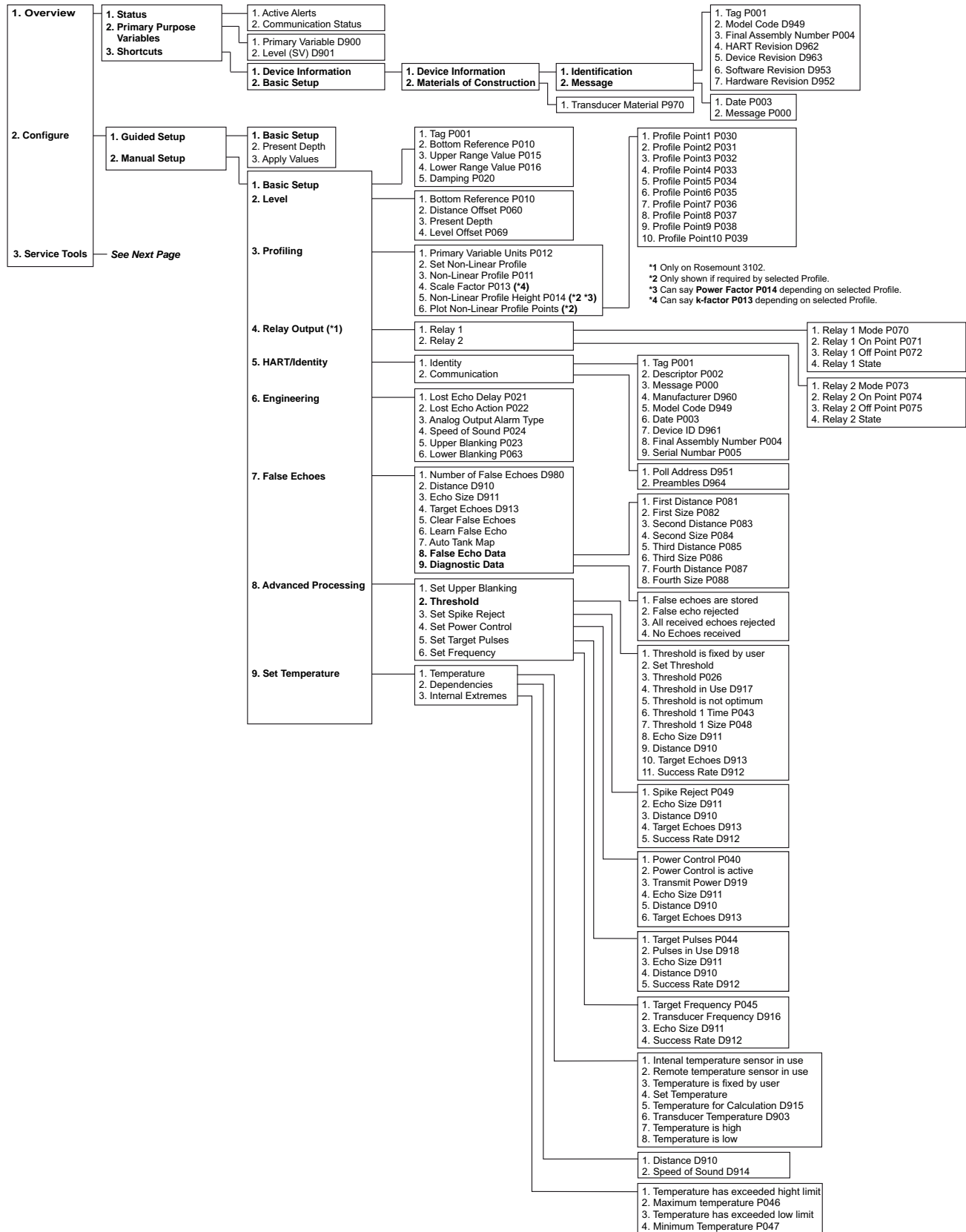

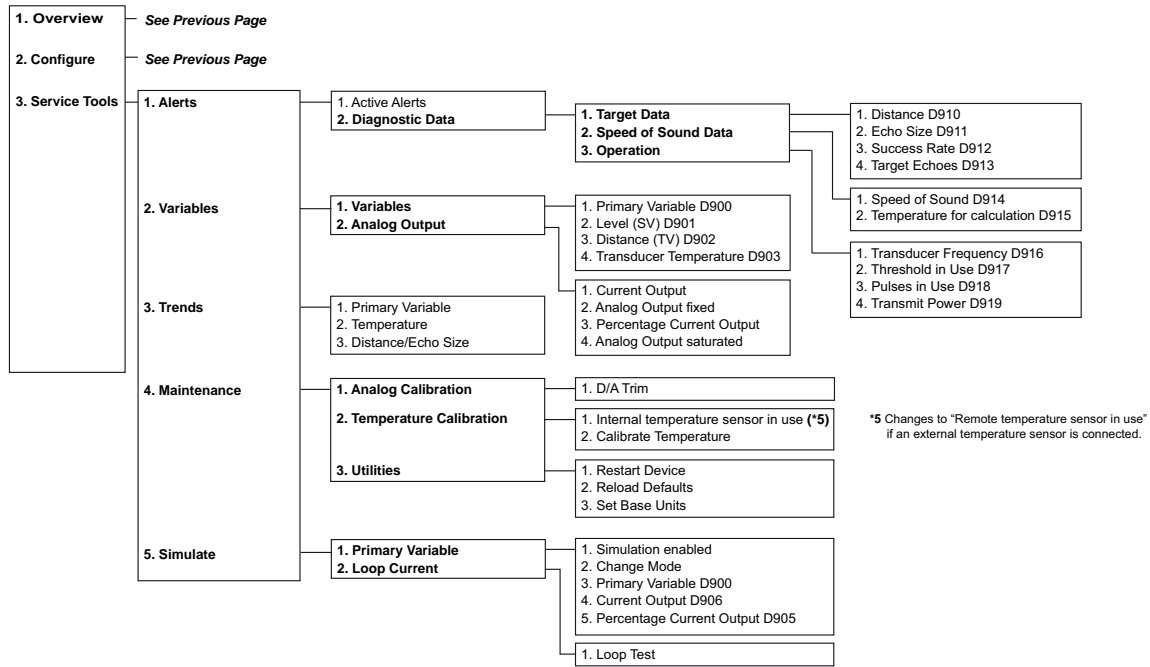

Appendix F Programming the 3102 and 3105 using HART

Overview of programming the 3102 and 3105	page 117
Command parameters	page 118
Configuration parameters	page 131
Monitoring and diagnostic parameters	page 193

F.1 Overview of programming the 3102 and 3105

The Rosemount 3102 and Rosemount 3105 support HART communications, which may be used to program or interrogate the transmitters from any point on the two-wire loop.

This section contains information on configuring the transmitters using a Field Communicator, PC with AMS Suite: Intelligence Device Manager, or Rosemount 3490 Series Control Unit.

F.1.1 Using a Rosemount 3490 Series Control Unit

A full menu map showing how to access transmitter parameters using the control unit's menu system is in [Appendix D: Rosemount 3490 Series Menus](#). For convenience, the parameter identification numbers (P*** and D***) are used in parameter headings and descriptions in this configuration section.

When using the control unit, use the Enter (↵) key to start editing a configuration parameter and then use the arrow keys to change the setting. Changes are confirmed by selecting the Enter key, or abandoned by selecting the Esc key. Commands e.g. Set As Empty are run using the Enter (↵) key.

Note

The product manual 00809-0100-4841 provides detailed instructions on installation and operation of the control unit

F.1.2 Using a Field Communicator or AMS Device Manager

For convenience, Field Communicator fast key sequences are labeled “Fast Keys” for each software function below the appropriate headings.

Example Software Function

Fast Keys	1, 2, 3, etc.
-----------	---------------

When using a Field Communicator, some configuration changes are sent to the transmitter by selecting “Send”.

AMS Device Manager configuration changes are implemented by selecting “Apply”.

Connect the Field Communicator leads to the transmitter, and turn on the Field Communicator by using the ON/OFF button. The Field Communicator will search for a HART-compatible device

and indicate when the connection is made. If the Field Communicator fails to connect, it indicates that no device was found. If this occurs, check the lead connections and re-try.

A full menu map showing how to access transmitter parameters using the Field Communicator is in [Appendix E: Field Communicator Menus](#).

F.2 Command parameters

F.2.1 Base units

Fast Keys	3, 4, 3, 3
------------------	------------

When the transmitter is shipped from the factory, the default factory setting for Base Units is “metric” or “imperial ft” depending on the model order code (see ["Ordering information" on page 87](#)).

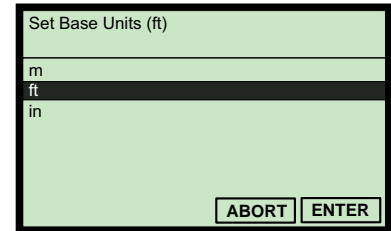

(Field Communicator Screen Shown)

Note

Keep a record of your programmed settings. Changing base units resets parameters to their default factory settings in the appropriate units.

Field Communicator

To view or change the transmitter base units

1. From the *Home* screen, select 3: Service Tools.
2. Select 4: Maintenance.
3. Select 3: Utilities.
4. Select 3: Set Base Units.
5. Use the up and down navigation keys to select new base units, and then save the selection by selecting “ENTER”.
6. Select “ENTER” to select 1: Yes (in response to “Are you sure?”).
7. Use the left navigation key to return to the previous menu.

Note

When messages appear, take appropriate action if needed and select “OK”.

Rosemount 3490 Series Control Unit

To view or change the transmitter base units

1. From the *Main Menu* screen, select SETUP.
2. Select the transmitter (e.g. “Tx1: 3102”).
3. Select SYSTEM.
4. Select Base Units.
5. Follow on-screen instructions to select and confirm the new base units.
6. Select “Quit” to exit to the previous menu.
7. To get the same base units on the control unit, switch the power off and then on again. The control unit prompts for the transmitter’s Bottom Reference value ([page 136](#)) in the new base units.

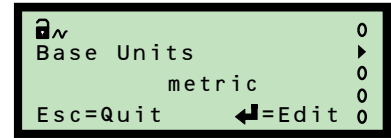

(Rosemount 3491 Screen Shown)

Note

The display (reported) units of the transmitter’s process value (PV) can be changed to *metric* or *imperial* measurement units using the parameter Primary Variable Units see ([page 153](#)). However, this does not automatically re-scale the PV. Use the parameter PV Scale Factor ([page 154](#)) to manually re-scale the value

F.2.2 Set as empty

Fast Keys	2, 2, 2, 3, 2
------------------	---------------

If the bottom reference is *unknown* and the tank is *empty*, the transmitter can change the Transmitter Bottom Reference value to the Distance measurement with the tank empty.

P010 = (D910 - P060)

Where:

P010 = Transmitter Bottom Reference setting (see [page 136](#)).

D910 = Distance measurement (see [page 199](#)).

P060 = Distance Offset setting (see [page 141](#)).

Field Communicator

To select the Set As Empty command

1. From the *Home* screen, select 2: Configure.
2. Select 2: Manual Setup.
3. Select 2: Level.
4. Select 3: Present Depth.
5. Select 2: Set as Empty, and then select “ENTER”.

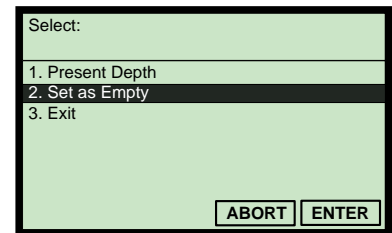

(Field Communicator Screen Shown)

Note

When messages appear, take appropriate action if needed and select “OK”.

Note

The command Set As Empty is also at Fast Key sequence 2, 1, 2.

Rosemount 3490 Series Control Unit

To select the Set As Empty command

1. From the *Main Menu* screen, select SETUP.
2. Select the transmitter (e.g. “Tx1: 3102”).
3. Select DUTY.
4. Select SET AS EMPTY.
5. Follow on-screen instructions to perform the Set As Empty action. (If prompted to change the mode to off-line, use the Enter key).
6. Select “Quit” to exit to the previous menu.

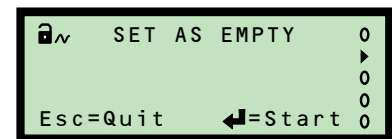

(Rosemount 3491 Screen Shown)

F.2.3 Present depth

Fast Keys	2, 2, 2, 3, 1
------------------	---------------

If the Bottom Reference is *unknown* but the present liquid depth is *known*, the transmitter can set the Transmitter Bottom Reference value using the Present Depth value, the live Distance measurement, and optional offsets:

$$P010 = (\text{Depth} + D910) - (P060 + P069)$$

Where:

P010= Transmitter Bottom Reference (see [page 136](#)).

Depth= Present Depth setting (live level value snapshot but can be edited).

D910= Distance measurement (see [page 199](#)).

P060= Distance Offset (see [page 141](#)).

P069= Level Offset (see [page 142](#)).

Field Communicator or AMS Device Manager

To use the Present Depth command

1. From the *Home* screen, select 2: Configure.
2. Select 2: Manual Setup.
3. Select 2: Level.
4. Select 3: Present Depth.
5. Select 1: Present Depth, and then select “ENTER”.
6. Follow the on-screen instructions to input the present depth, which will then change the transmitter’s bottom reference using the above P010 calculation.
7. Select “ENTER” to confirm the input present depth.

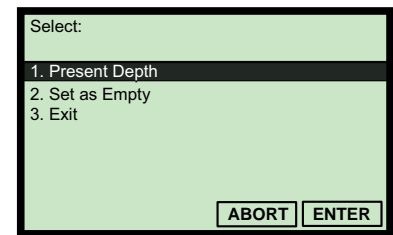

(Field Communicator Screen Shown)

Note

When messages appear, take appropriate action if needed and select “OK”.

Note

The feature Present Depth is also at Fast Key sequence 2, 1, 2.

Rosemount 3490 Series Control Unit

To select the Present Depth command

1. From the *Main Menu* screen, select SETUP
2. Select the transmitter (e.g. “Tx1: 3102”).
3. Select DUTY.
4. Select Present Depth.
5. Follow the on-screen instructions to input the present depth, which will then change the transmitter’s bottom reference using the calculation.
(If prompted to change the mode to “off-line”, use the Enter key).
6. Select “Quit” to exit to the previous menu.

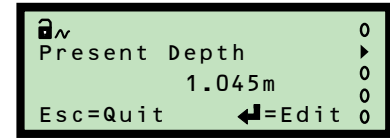

(Rosemount 3491 Screen Shown)

F.2.4 Learn false echo

Fast Keys	2, 2, 6 [or 7], 6
------------------	-------------------

The transmitter can be manually told the live Distance (on [page 199](#)) is being calculated from a *false target echo* and that echo can therefore be ignored.

If there is another false target echo, repeat the learning process again. A maximum of four false echoes can be learnt.

Field Communicator or AMS Device Manager

To ignore a false target echo

1. From the *Home* screen, select 2: Configure.
2. Select 2: Manual Setup.
3. Select 6: False Echoes (3105) or 7: False Echoes (3102).
4. Select 6: Learn False Echo.
5. Wait three seconds while the transmitter learns to ignore the false echo.

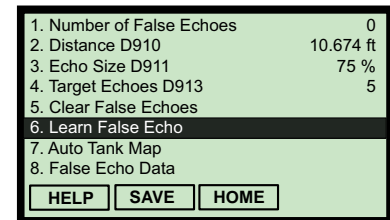

(Field Communicator Screen Shown)

Note

When messages appear, take appropriate action if needed and select “OK”.

Rosemount 3490 Series Control Unit

To ignore a false target echo

1. From the *Main Menu* screen, select SETUP.
2. Select the transmitter (e.g. “Tx1: 3102”).
3. Select ENGINEERING.
4. Select FALSE ECHO ACTION.
5. Select Learn False Echo.
6. Follow the on-screen instruction (“Start”) to ignore a false echo.
(Use the Enter (↵) key if prompted to change the mode to “off-line”).
7. Select “Quit” to exit to the previous menu.

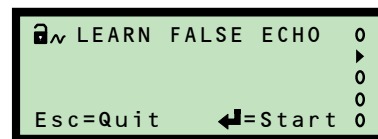

(Rosemount 3491 Screen Shown)

Note

See Clear False Echoes on [page 187](#) for how to clear all learned false echoes.

See False Echo Data on [page 186](#) for how to edit existing false echo data.

Use the “Auto Tank Map” feature for automatic learning ([page 124](#)).

F.2.5 Auto tank map

Fast Keys	2, 2, 6 [or 7], 7
------------------	-------------------

The transmitter can automatically map up to four echoes from false targets within an empty tank. The tank needs to be empty so that echoes from all false targets are exposed.

Note

Set the Transmitter Bottom Reference (page 136) before using Auto Tank Map.

Field Communicator or AMS Device Manager

To automatically map up to four echoes from false targets

1. From the *Home* screen, select 2: Configure.
2. Select 2: Manual Setup.
3. Select 6: False Echoes (3105) or 7: False Echoes (3102).
4. Select 7: Auto Tank Map.
5. Wait while the transmitter learns about the empty tank to ignore the false echoes. This process takes less than one minute.

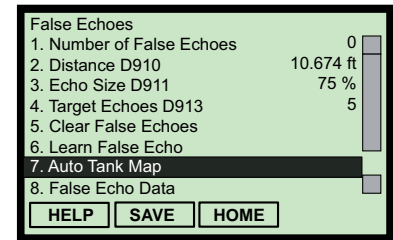

(Field Communicator Screen Shown)

Note

When messages appear, take appropriate action if needed and select “OK”.

Rosemount 3490 Series Control Unit

To automatically map up to four echoes from false targets:

1. From the *Main Menu* screen, select SETUP.
2. Select the transmitter (e.g. “Tx1: 3102”).
3. Select ENGINEERING.
4. Select FALSE ECHO ACTION.
5. Select Auto Tank Map.
6. Follow the on-screen instruction (“**start**”) to ignore a false echo. (Use the Enter key if prompted to change the mode to “off-line”).
7. Wait while the transmitter learns about the empty tank to ignore the false echoes. The process takes less than one minute.
8. Select “**Quit**” to exit to the previous menu.

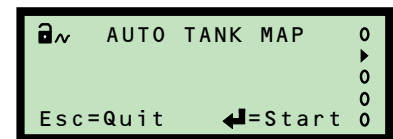

(Rosemount 3491 Screen Shown)

Note

- See Clear False Echoes on page 187 for how to clear all learned false echoes
- See False Echo Data on page 186 for how to edit existing false echo data
- Use the “Learn False Echo” feature manual learning (page 122)

F.2.6 Simulation of PV

Fast Keys	3, 5, 1
-----------	---------

The transmitter simulations automatically cycle the PV between the bottom of the tank and the nearest measurable distance. The cycle direction is given by the name of the simulation mode selected.

Simulation modes are:

- “Run up” – cycles up, and then down, repeatedly until stopped.
- “Run down” – cycles down, and then up, repeatedly until stopped.
- “Run from Zero” – as “Run up” except the PV initially starts from 0.

A single cycle takes 100 seconds to complete. The Current Output responds according to the PV.

The cycling may be paused with the “pause” mode, and then re-started by selecting another simulation mode.

To stop the cycling, select the “normal” mode.

Field Communicator or AMS Device Manager

To use the simulation tool

1. From the *Home* screen, select 3: Service Tools.
2. Select 5: Simulate.
3. Select 1: Primary Variable.
4. Select 2: Change Mode.
5. Select a simulation mode e.g. 2: Run Up.
6. The simulation is now running, and Simulation Enabled is “ON”.
7. Monitor the parameters Primary Variable (PV), Current Output, and Percentage of Current Output on the LCD screen.
8. When finished, change the mode to “Normal”.

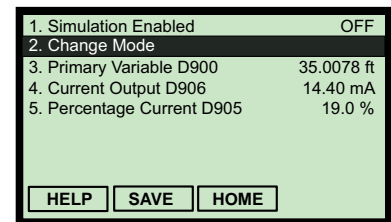

(Field Communicator Screen Shown)

Note

When messages appear, take appropriate action if needed and select “OK”.

Rosemount 3490 Series Control Unit

To use the simulation tool

1. From the *Main Menu* screen, select SETUP.
2. Select the transmitter (e.g. “Tx1: 3102”).
3. Select SYSTEM, and then select Simulation.
4. Select a simulation mode.
5. When finished, select “Quit” to exit to the previous menu.

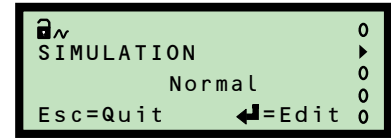

(Rosemount 3491 Screen Shown)

F.2.7 Restart device

Fast Keys	3, 4, 3, 1
-----------	------------

This re-starts the transmitter as if the power has been interrupted.

Field Communicator or AMS Device Manager

To restore the original factory configuration

1. From the *Home* screen, select 3: Service Tools.
2. Select 4: Maintenance.
3. Select 3: Utilities.
4. Select 1: Restart Device.
5. When the message “About to restart the transmitter” appears, select “OK” to continue (or “ABORT” to not continue).
6. Select 1: Yes to restart the transmitter.

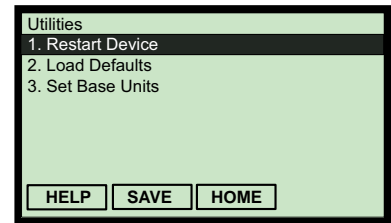

(Field Communicator Screen Shown)

Note

When messages appear, take appropriate action if needed and select “OK”.

Rosemount 3490 Series Control Unit

To restore the original factory configuration

1. From the *Main Menu* screen, select SETUP.
2. Select the transmitter (e.g. “Tx1: 3102”).
3. Select SYSTEM, and then select RESTART DEVICE.
4. Follow the on-screen instruction (“**start**”) to restart the transmitter. (Use the Enter (↵) key if prompted to change the mode to “off-line”).
5. Select “Quit” to exit to the previous menu.

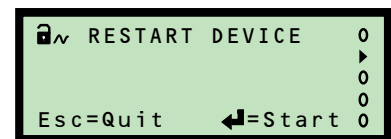

(Rosemount 3491 Screen Shown)

F.2.8 Load defaults

Fast Keys	3, 4, 3, 2
-----------	------------

This restores the transmitter parameters to the factory default values for the selected base units. This is sometimes necessary, particularly if the data held in the transmitter is in doubt.

Note

Restoring the factory defaults values overwrites all site entered data. After loading the factory defaults, the transmitter automatically re-starts and communication is interrupted until the re-start is complete.

Field Communicator or AMS Device Manager

To restore the factory default settings of the transmitter

1. From the *Home* screen, select 3: Service Tools.
2. Select 4: Maintenance.
3. Select 3: Utilities.
4. Select 2: Load Defaults.
5. When the message “About to restore factory defaults” appears, select “OK” to continue (or “ABORT” to not continue).
6. Select 1: Yes to restore the factory defaults.

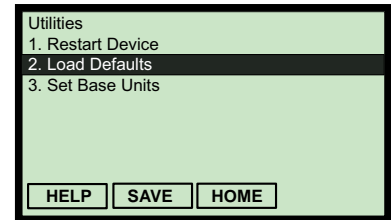

(Field Communicator Screen Shown)

Note

When messages appear, take appropriate action if needed and select “OK”.

Rosemount 3490 Series Control Unit

To restore the factory default settings of the transmitter

1. From the *Main Menu* screen, select SETUP.
2. Select the transmitter (e.g. “Tx1: 3102”).
3. Select SYSTEM, and then select DEFAULTS.
4. Follow the on-screen instructions (select “start” and answer “Yes”) to restore the factory defaults. Use the Enter (↵) key if prompted to change the mode to “off-line”.
5. Select “Quit” to exit to the previous menu.

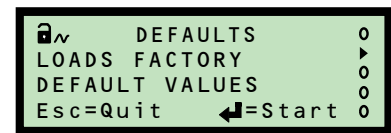

(Rosemount 3491 Screen Shown)

F.2.9 Simulate current output

Fast Keys	3, 5, 2, 1
------------------	------------

This forces a fixed output current in the range 4 to 20 mA. This feature *temporarily* overrides the normal function of the transmitter's PV driving the 4–20 mA Current Output until exiting to the previous menu.

Note

The simulation is automatically cancelled after 20 minutes, and the output current returns to representing the transmitter's PV.

Field Communicator or AMS Device Manager

To fix the output current

1. From the *Home* screen, select 3: Service Tools.
2. Select 5: Simulate.
3. Select 2: Loop Current.
4. Select 1: Loop Test.
5. Select the required output current e.g. 1: 4mA.
6. When a message appears saying the output current is fixed, select "OK".
7. Select 4: End to exit and restore the output current to normal.

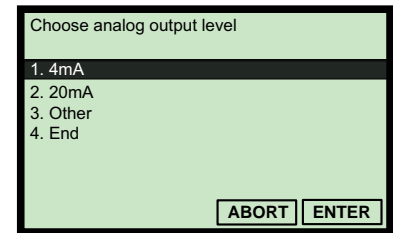

(Field Communicator Screen Shown)

Note

When messages appear, take appropriate action if needed and select "OK".

Rosemount 3490 Series Control Unit

To fix the output current:

1. From the *Main Menu* screen, select SETUP.
2. Select the transmitter (e.g. "Tx1: 3102").
3. Select SYSTEM, and then select TRIM.
4. Select Fix Current.
5. Follow on-screen instructions to input the required output current. (Use the Enter (↵) key if prompted to change mode to "off-line").
6. When finished, select "Quit" to exit to the previous menu.

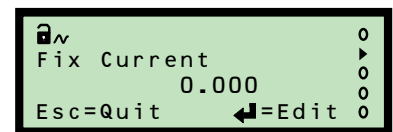

(Rosemount 3491 Screen Shown)

F.2.10 Trim 4 mA / trim 20 mA

Fast Keys	3, 4, 1, 1
-----------	------------

This is for calibrating the 4 mA and 20 mA output current from the transmitter. The output current is temporarily set to 4 mA and 20 mA. Measure the *actual output current* and then input that mA value to re-calibrate. The output current resumes normal operation after exiting.

Note

The re-calibration procedure is automatically cancelled after 20 minutes of inactivity, and the previous calibration is restored.

Field Communicator or AMS Device Manager

To re-calibrate the 4 mA and 20 mA output current

1. From the *Home* screen, select 3: Service Tools.
2. Select 4: Maintenance,
3. Select 1: Analog Calibration.
4. Select 1: D/A Trim.
5. Follow the instruction “Connect reference meter”, and then select “OK”.
6. Input the measured mA from the reference meter, and select “ENTER”.
7. Select 1: Yes.
8. Select “OK” to now calibrate the 20 mA output current.
9. Input the measured mA from the reference meter, and select “ENTER”.
10. Select 1: Yes. (The output current now returns to normal operation).

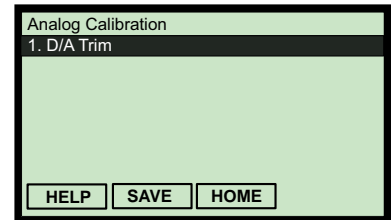

(Field Communicator Screen Shown)

Note

When messages appear, take appropriate action if needed and select “OK”.

Rosemount 3490 Series Control Unit

To re-calibrate the 4 mA output current

1. From the *Main Menu* screen, select SETUP.
2. Select the transmitter (e.g. “Tx1: 3102”).
3. Select SYSTEM.
4. Select TRIM.
5. Select Trim 4mA.
6. Connect a reference meter.
7. Follow the on-screen instructions to start the re-calibration feature.
(Use the Enter (↵) key if prompted to change the mode to “off-line”).
8. Input the measured mA from the reference meter, and select “save”.
9. Select the “Quit” instruction to exit.

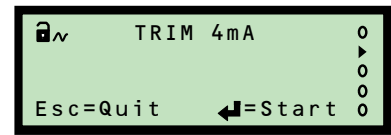

(Rosemount 3491 Screen Shown)

To re-calibrate the 20 mA output current:

1. From the *Main Menu* screen, select SETUP.
2. Select the transmitter (e.g. “Tx1: 3102”).
3. Select SYSTEM.
4. select TRIM.
5. Select Trim 20mA.
6. Follow the on-screen instructions to start the re-calibration feature.
(Use the Enter (↵) key if prompted to change mode to “off-line”).
7. Measure the *actual output current*, and input that new value.
8. Select “Quit” to exit to the previous menu.

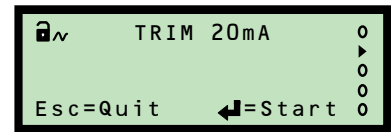

(Rosemount 3491 Screen Shown)

F.3 Configuration parameters

F.3.1 Message (P000)

Fast Keys	2, 2, 4 [or 5], 1, 3
------------------	----------------------

This allows a general 32-character message to be edited (12 characters if using a Rosemount 3490 Series Control Unit). It can be used for any purpose, such as a support contact number or details of the last programming change.

Field Communicator or AMS Device Manager

To view or change the message

1. From the *Home* screen, select 2: Configure.
2. Select 2: Manual Setup.
3. Select 4: HART / Identity (3105) or 5: HART / Identity (3102).
4. Select 1: Identity.
5. Select 3: Message P000.
6. If a change is required:
 - (a) Input the new message, and then select “ENTER” to save it.
 - (b) Select “Send” or “Apply” to update the transmitter.

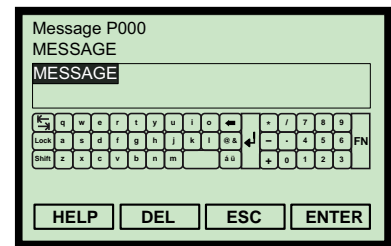

(Field Communicator Screen Shown)

Rosemount 3490 Series Control Unit

To view or change the message

1. From the *Main Menu* screen, select SETUP.
2. Select the transmitter (e.g. “Tx1: 3102”).
3. Select DUTY.
4. Select IDENTITY.
5. Select Message.
6. Follow on-screen instructions to input and save the message.
7. Select “Quit” to exit to the previous menu.

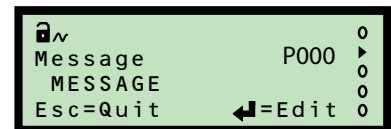

(Rosemount 3491 Screen Shown)

F.3.2 Tag (P001)

Fast Keys	2, 2, 4 [or 5], 1, 1
------------------	----------------------

This is for editing an electronic ‘label’ of up to 8 characters for the transmitter. The tag is typically a reference number, location, or duty description.

Field Communicator or AMS Device Manager

To view or change the tag

1. From the *Home* screen, select 2: Configure.
2. Select 2: Manual Setup.
3. Select 4: HART / Identity (3105) or 5: HART / Identity (3102).
4. Select 1: Identity, and then select 1: Tag P001.
5. If required:
 - (a) Input the new tag, and then select “ENTER” to save it.
 - (b) Select “Send” or “Apply” to update the transmitter.

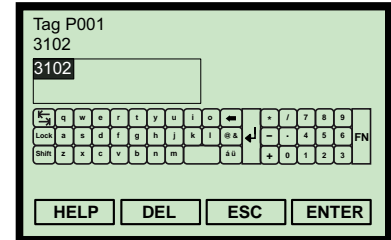

(Field Communicator Screen Shown)

Rosemount 3490 Series Control Unit

To view or change the tag

1. From the *Main Menu* screen, select SETUP.
2. Select the transmitter (e.g. “Tx1: 3102”).
3. Select DUTY, and then select IDENTITY.
4. Select Tag.
5. Follow on-screen instructions to input and save the tag.
6. Select “Quit” to exit to the previous menu.

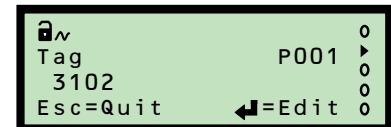

(Rosemount 3491 Screen Shown)

F.3.3 Descriptor (P002)

Fast Keys	2, 2, 4 [or 5], 1, 2
------------------	----------------------

This is for editing up to 16 characters, and can be used for any purpose e.g. to expand on Tag (page 132) if needed.

Field Communicator or AMS Device Manager

To view or change the descriptor

1. From the *Home* screen, select 2: Configure.
2. Select 2: Manual Setup.
3. Select 4: HART / Identity (3105) or 5: HART / Identity (3102).
4. Select 1: Identity.
5. Select 2: Descriptor P002.
6. If required:
 - (a) Input the descriptor, and then select “ENTER” to save it.
 - (b) Select “Send” or “Apply” to update the transmitter.

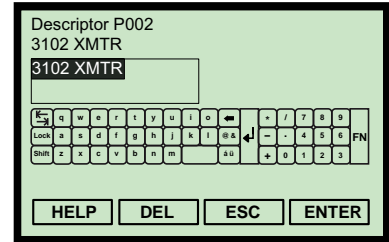

(Field Communicator Screen Shown)

Rosemount 3490 Series Control Unit

To view or change the descriptor

1. From the *Main Menu* screen, select SETUP.
2. Select the transmitter (e.g. “Tx1: 3102”).
3. Select DUTY.
4. Select IDENTITY.
5. Select Descriptor.
6. Follow on-screen instructions to input and save the descriptor.
7. Select “Quit” to exit to the previous menu.



(Rosemount 3491 Screen Shown)

F.3.4 Final assembly number (P004)

Fast Keys	2, 2, 4 [or 5], 1, 8
------------------	----------------------

This is a read-only parameter showing a multiple-digit number. It is used by the factory to track the manufacturing history of an individual transmitter.

Field Communicator or AMS Device Manager

To view the final assembly number

1. From the *Home* screen, select 2: Configure.
2. Select 2: Manual Setup.
3. Select 4: HART / Identity (3105) or 5: HART / Identity (3102).
4. Select 1: Identity.
5. Select 8: Final Assembly Number P004.
6. Select "EXIT" to exit to the previous menu.

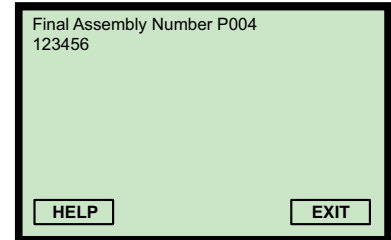

(Field Communicator Screen Shown)

Rosemount 3490 Series Control Unit

To view the final assembly number

1. From the *Main Menu* screen, select SETUP.
2. Select the transmitter (e.g. "Tx1: 3102").
3. Select SYSTEM.
4. Select FIXED.
5. Select Final Assy No.
6. When finished, use the ESC key to exit to the previous menu.

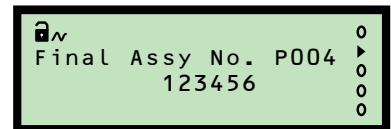

(Rosemount 3491 Screen Shown)

F.3.5 Serial number (P005)

Fast Keys	2, 2, 4 [or 5], 1, 9
------------------	----------------------

This is a read-only parameter showing a multiple-digit number. It is used by the factory to identify an individual transmitter.

Field Communicator or AMS Device Manager

To view the serial number

1. From the *Home* screen, select 2: Configure.
2. Select 2: Manual Setup.
3. Select 4: HART / Identity (3105) or 5: HART / Identity (3102).
4. Select 1: Identity.
5. Select 9: Serial Number P005.
6. Select “EXIT” to exit to the previous menu.

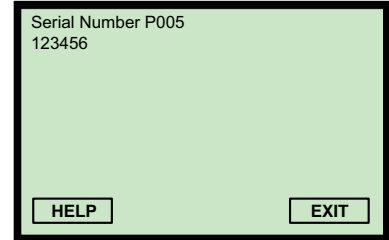

(Field Communicator Screen Shown)

Rosemount 3490 Series Control Unit

To view the serial number

1. From the *Main Menu* screen, select SETUP.
2. Select the transmitter (e.g. “Tx1: 3102”).
3. Select SYSTEM.
4. Select FIXED.
5. Select Serial Number.
6. When finished, use the ESC key to exit to the previous menu.

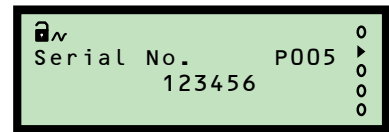

(Rosemount 3491 Screen Shown)

F.3.6 Bottom reference (P010)

Fast Keys	2, 2, 1, 2
------------------	------------

This is the transmitter's Bottom Reference setting. It is the distance measured vertically along the ultrasonic beam path from the *user preferred sensor reference point* to the *zero level* of a tank or an open channel (see [Figure F-1 on page 137](#)). It is not necessary to have the 4 mA output start at the zero level, and the 4 mA starting pointing can be any liquid height above or below this zero level.

Note

This parameter is important for calibrating and configuring the transmitter.

Field Communicator or AMS Device Manager

To view or change the bottom reference

1. From the *Home* screen, select 2: Configure.
2. Select 2: Manual Setup.
3. Select 1: Basic Setup.
4. Select 2: Bottom Reference P010.
5. If a change is required:
 - (a) Input the new bottom reference, and then select "ENTER" to save it.
 - (b) Select "Send" or "Apply" to update the transmitter.

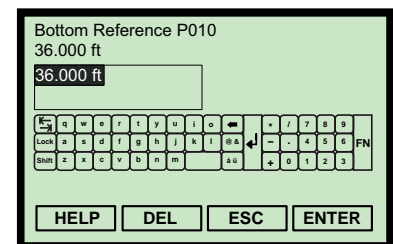

(Field Communicator Screen Shown)

Rosemount 3490 Series Control Unit

To view or change the bottom reference

1. From the *Main Menu* screen, select SETUP.
2. Select the transmitter (e.g. "Tx1: 3102").
3. Select DUTY.
4. Select Bottom Ref.
5. Follow the on-screen instructions to input and save the new setting. (Use the Enter (↵) key if prompted to change mode to "off-line").
6. Select "Quit" to exit to the previous menu.

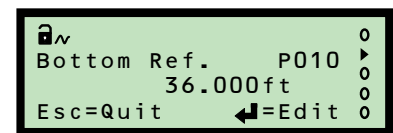

(Rosemount 3491 Screen Shown)

Figure F-1. Tank Geometry

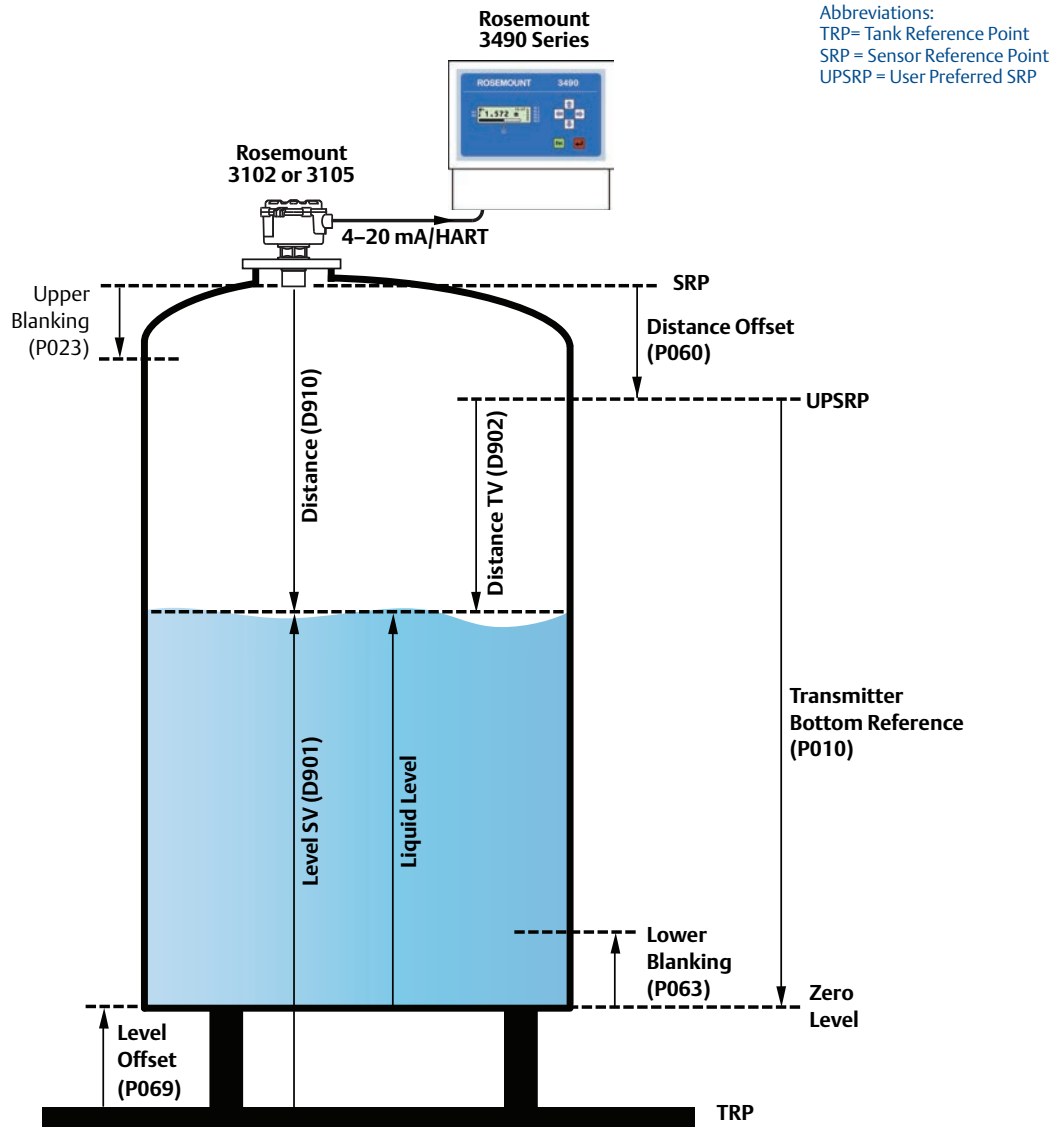

Data processing sequence:

1. Echoes are processed that occur between Upper Blanking (P023) and Lower Blanking (P063), unless P063 is set to zero.
2. D910 is derived from the Target Echo's Time of Flight and the calculated Speed of Sound: $D910 = (\text{Time of Flight} * \text{Speed of Sound}) / 2$
3. $D902 = (D910 - P060)$
4. $\text{Liquid Level} = (P010 - D902)$
5. $D901 = (\text{Liquid Level} + P069)$

F.3.7 Upper blanking (P023)

Fast Keys	2, 2, 5 [or 6], 5
------------------	-------------------

This defines a zone close to the transmitter where echoes are to be ignored. Establishing this zone eliminates echoes from false targets such as mounting fittings or the end of stub pipes.

Enter the vertical distance from the transmitter face to where a valid surface echo can be detected. See [Figure F-1 on page 137](#) for this zone in a tank geometry illustration.

Note

To avoid a false high level alarm, the upper blanking distance should not be set to less than the factory default setting.

Note

The pulse transmission stops if the sum of the Lower Blanking ([page 142](#)) and Upper Blanking and is greater than the Transmitter Bottom Reference ([page 136](#)).

Field Communicator or AMS Device Manager

To view or change the upper blanking distance

1. From the *Home* screen, select 2: Configure.
2. Select 2: Manual Setup.
3. Select 5: Engineering (3105) or 6: Engineering (3102).
4. Select 5: Upper Blanking P023.
5. If a change is required:
 - (a) Input the new blanking distance, and select “ENTER” to save it.
 - (b) Select “Send” or “Apply” to update the transmitter.

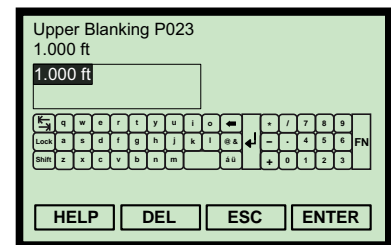

(Field Communicator Screen Shown)

Note

When messages appear, take appropriate action if needed and select “OK”.

Rosemount 3490 Series Control Unit

To view or change the upper blanking distance

1. From the *Main Menu* screen, select SETUP.
2. Select the transmitter (e.g. "Tx1: 3102").
3. Select ENGINEERING.
4. Select Upper Blanking.
5. Follow the on-screen instructions to edit and save the new setting. (Use the Enter (↵) key if prompted to change mode to "off-line").
6. Select "Quit" to exit to the previous menu.

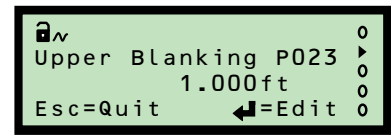

(Rosemount 3491 Screen Shown)

F.3.8 Lower blanking (P063)

Fast Keys	2, 2, 5 [or 6], 6
------------------	-------------------

This defines a zone above the Transmitter Bottom Reference (page 136) where echoes are to be ignored. This zone eliminates echoes from false targets at the tank bottom e.g. pumps uncovered as the liquid level decreases. See Figure F-1 on page 137 for this zone in a tank geometry illustration.

Note

The pulses transmission stops if the sum of the Upper Blanking (page 174) and Lower Blanking is greater than the Transmitter Bottom Reference (page 136).

Field Communicator or AMS Device Manager

To view or change the lower blanking distance

1. From the *Home* screen, select 2: Configure.
2. Select 2: Manual Setup.
3. Select 5: Engineering (3105) or 6: Engineering (3102).
4. Select 6: Lower Blanking.
5. If a change is required:
 - (a) Input the new blanking distance, and select “ENTER” to save it.
 - (b) Select “Send” or “Apply” to update the transmitter.

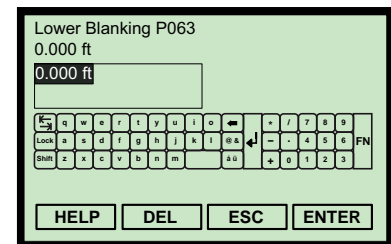

(Field Communicator Screen Shown)

Note

When messages appear, take appropriate action if needed and select “OK”.

Rosemount 3490 Series Control Unit

To view or change the lower blanking distance

1. From the *Main Menu* screen, select SETUP.
2. Select the transmitter (e.g. “Tx1: 3102”).
3. Select ENGINEERING.
4. Select Lower Blanking.
5. Follow the on-screen instructions to edit and save the new setting. (Use the Enter (↵) key if prompted to change mode to “off-line”).
6. Select “Quit” to exit to the previous menu.

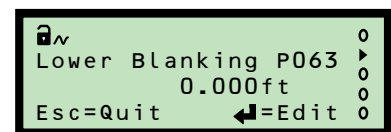

(Rosemount 3491 Screen Shown)

F.3.9 Distance offset (P060)

Fast Keys	2, 2, 2, 2
------------------	------------

This defines the distance from the Sensor Reference Point (SRP) to the User Preferred Sensor Reference Point (UPSRP). See [Figure F-1 on page 137](#) for these points in a tank geometry illustration.

The read-only Distance / Tertiary Variable value ([page 195](#)) is calculated by subtracting the distance offset from the live Distance value ([page 199](#)).

Note

The live Distance value is not affected by changes to the distance offset.

Field Communicator or AMS Device Manager

To view or change the distance offset

1. From the *Home* screen, select 2: Configure.
2. Select 2: Manual Setup.
3. Select 2: Level.
4. Select 2: Distance Offset P060.
5. If a change is required:
 - (a) Input the new distance offset, and select “ENTER” to save it.
 - (b) Select “Send” or “Apply” to update the transmitter.

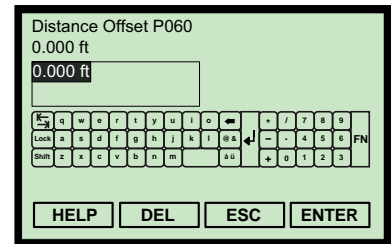

(Field Communicator Screen Shown)

Note

When messages appear, take appropriate action if needed and select “OK”.

Rosemount 3490 Series Control Unit

To view or change the distance offset

1. From the *Main Menu* screen, select SETUP.
2. Select the transmitter (e.g. “Tx1: 3102”).
3. Select DUTY.
4. Select Distance Offset.
5. Follow the on-screen instructions to edit and save the new setting. (Use the Enter (↵) key if prompted to change mode to “off-line”).
6. Select “Quit” to exit to the previous menu.

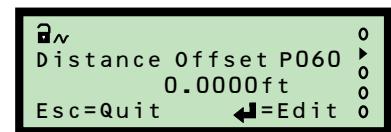

(Rosemount 3491 Screen Shown)

F.3.10 Level offset (P069)

Fast Keys	2, 2, 2, 4
------------------	------------

This defines the distance from the Tank Reference Point (TRP) to the transmitter's Bottom Reference. See [Figure F-1 on page 137](#) for these points in a tank geometry illustration.

The read-only Level / Secondary Variable value ([page 194](#)) is calculated by adding the level offset and the measured level.

Field Communicator or AMS Device Manager

To view or change the level offset

1. From the *Home* screen, select 2: Configure.
2. Select 2: Manual Setup.
3. Select 2: Level.
4. Select 4: Level Offset P069.
5. If a change is required:
 - (a) Input the new level offset, and select "ENTER" to save it.
 - (b) Select "Send" or "Apply" to update the transmitter.



(Field Communicator Screen Shown)

Note

When messages appear, take appropriate action if needed and select "OK".

Rosemount 3490 Series Control Unit

To view or change the level offset

1. From the *Main Menu* screen, select SETUP.
2. Select the transmitter (e.g. "Tx1: 3102").
3. Select DUTY.
4. Select Level Offset.
5. Follow the on-screen instructions to edit and save the new setting. (Use the Enter (↵) key if prompted to change the mode to "off-line").
6. Select "Quit" to exit to the previous menu.

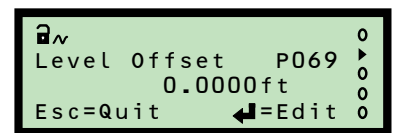

(Rosemount 3491 Screen Shown)

F.3.11 Tank shape / non-linear profile (P011)

Fast Keys	2, 2, 3, 2
------------------	------------

This selects the shape of a tank or an open channel, and establishes the linear or non-linear relationship between the live liquid level (height) and the process value (PV) derived from that level.

Note

- The display (reported) measurement units for the output process value (PV) are set using the Primary Variable Units parameter (page 153). However, this does not automatically re-scale the PV. Use the parameter PV Scale Factor (page 154) to manually re-scale the value

The transmitter is pre-programmed with popular profiles that are mathematical formulas to convert a linear level reading to a flow or volumetric process value (PV). The Current Output is then driven by the flow or volumetric PV.

The profile options are described in the following sections:

- "Contents (volume) measurement" on page 145
- "Flow measurement" on page 150

Field Communicator or AMS Device Manager

To change the tank shape/non-linear profile

1. From the *Home* screen, select 2: Configure.
2. Select 2: Manual Setup.
3. Select 3: Profiling.
4. Select 2: Set Non-Linear Profile.
5. Select a new profile, and then select "ENTER" to save the selection.
6. Select "Send" or "Apply" to update the transmitter.

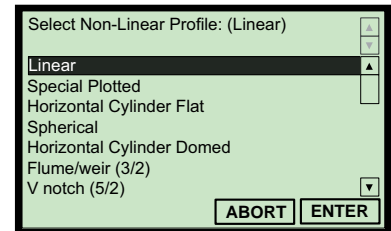

(Field Communicator Screen Shown)

Note

When messages appear, take appropriate action if needed and select "OK".

Note

The selected profile can be viewed at Fast Key sequence 2, 2, 3, 3.

Rosemount 3490 Series Control Unit

To view or change the tank shape/non-linear profile

1. From the *Main Menu* screen, select SETUP.
2. Select the transmitter (e.g. “Tx1: 3102”).
3. Select DUTY.
4. Select Tank Shape.
5. Follow the on-screen instructions to select and save the new setting. (Use the Enter (↵) key if prompted to change mode to “off-line”).
6. Select “Quit” to exit to the previous menu.

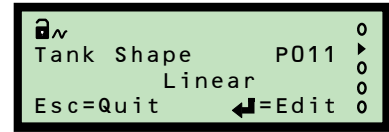

(Rosemount 3491 Screen Shown)

F.3.12 Contents (volume) measurement

There are five shape options available to select, including:

- Tank Shape/NLP (P011) = “Linear” (see page 145)
- Tank Shape/NLP (P011) = “Special Plot” (see page 145)
- Tank Shape/NLP (P011) = “Horizontal Cyl Flat” (see page 148)
- Tank Shape/NLP (P011) = “Spherical” (see page 148)
- Tank Shape/NLP (P011) = “Horizontal Cyl Dome” (see page 149)

Tank Shape/NLP (P011) = “Linear”

This default setting is for level or volume (content) measurements involving a tank with a constant cross-section. When “Linear” is selected, the level or volume is the liquid height above the *zero level* multiplied by a scaling factor. If volume is not required, the Scale Factor parameter (page 154) is set to 1.0 unless other measurement units for the output PV are required.

The volume of the contents is calculated by entering the volume-per-meter of height into the Scale Factor parameter (page 154). If the liquid level is being measured in feet or inches, enter the volume-per-foot or volume-per-inch respectively.

Tank Shape/NLP (P011) = “Special Plot”

When selecting “Special Plot”, parameters Profile Point 1 to 10 (page 158) can be edited to plot the unique profile of an irregular shaped tank or open channel (see Figure F-2).

To derive the 10 profile points, it is necessary to have tabulated or graphical data to relate the process value (PV) to the live liquid height. Figure F-3 on page 147 shows an example graph of PV versus Liquid Height. In the example, 60% of the maximum height on the X-axis relates to a percentage of the maximum PV on the Y-axis. The related percentage, say 55%, is entered into parameter Profile Point 6.

The transmitter will interpolate linearly between the plotted points to give an accurate curve fit, which will determine the output PV from the live level (height) measurement.

Each live level measurement is converted into a percentage (0 to 100%), which is proportional to the maximum height. In graph terms, the converted percentage corresponds to an X ordinate on the X-axis. Using this X ordinate, the Y ordinate is then calculated to get a percentage proportional to the maximum PV. This percentage is multiplied by the maximum height to get the output process value (PV).

Figure F-2. Two-stage Weir Cross-section

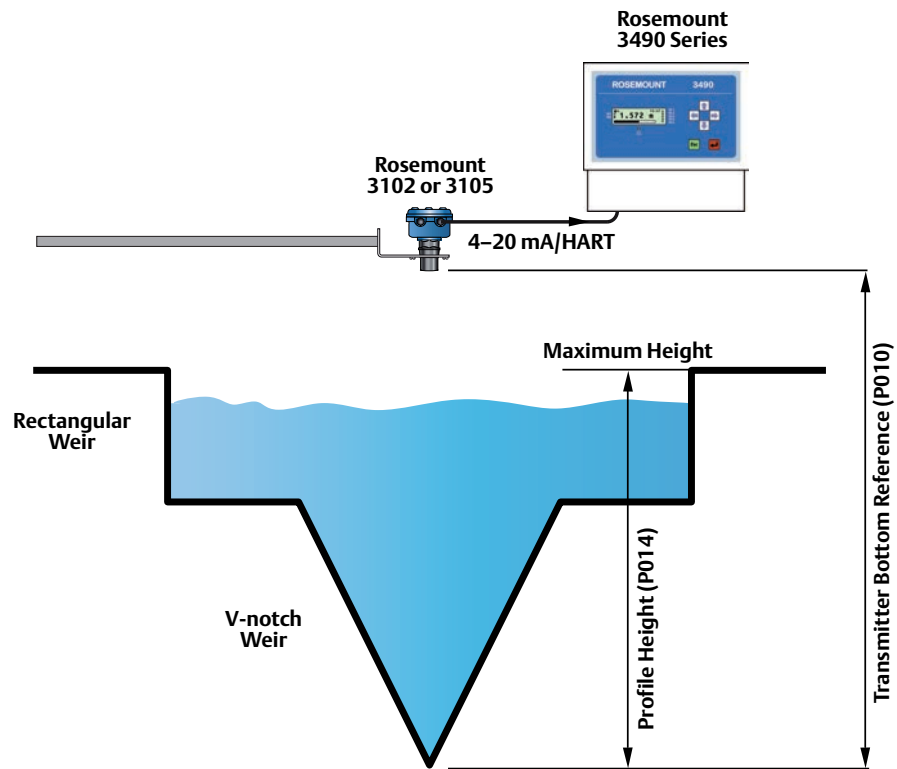

Setting-up procedure for the “Special Plot” option:

1. Select the displayed (reported) units for the output PV (see [page 153](#)).
2. Draw the graph of PV versus Liquid Height, and note the maximum points.
3. Enter the *maximum* liquid height into Profile Height ([page 156](#)).
4. Enter the *maximum* volume or flow into PV Scale Factor ([page 154](#)).
5. Enter the distance from the transmitter face to the zero point (Y=0) into the Transmitter Bottom Reference parameter ([page 136](#)).
6. Use parameters Profile Point 1 (P030) to Profile Point 10 (P039) to enter the percentage values that relate to the X-axis fixed percentages.

Note

The origin (0,0) is always used as the start point. It is not a parameter.

Note

It is possible that the process value (PV) at the maximum height is less than 100% of the maximum volume or flow (see [Figure F-4 on page 147](#)).

Figure F-3. Graph 1 of PV versus Height

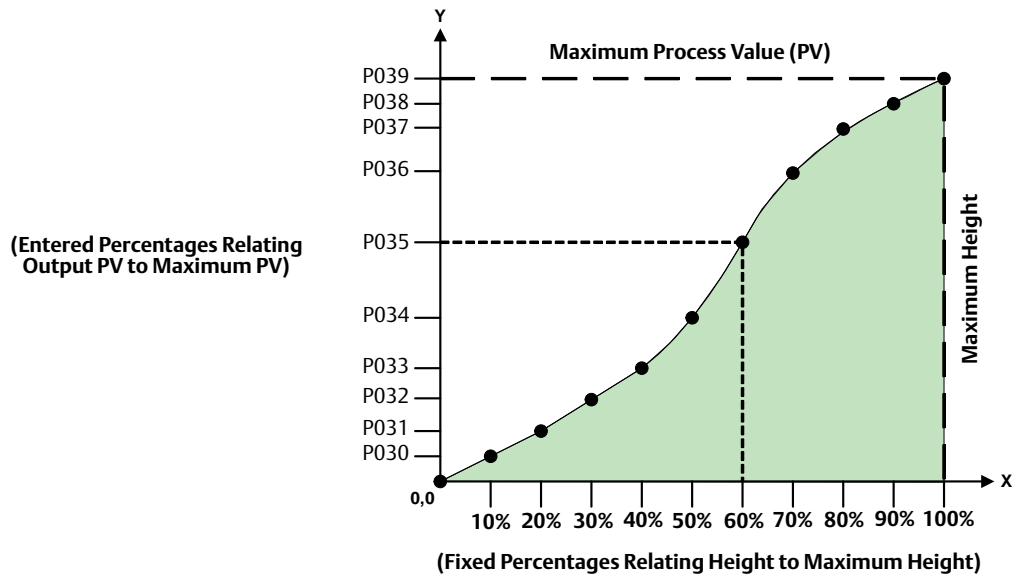
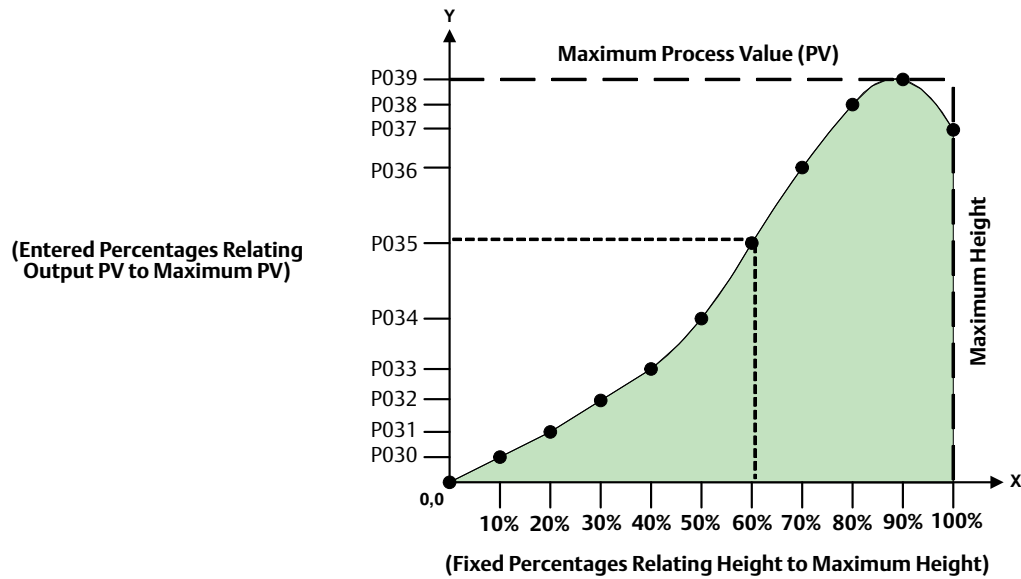

Figure F-4. Graph 2 of PV versus Height



Tank Shape/NLP (P011) = “Horizontal Cyl Flat”

This Horizontal Cylinder With Flat Ends setting is applicable when volume measurements are needed from a horizontally-oriented cylindrical tank with a constant diameter (see [Figure F-5](#) on [page 148](#) for a cross-sectional view).

The volume is calculated from the live level measurement, the full volume of an ideal cylindrical tank, and the diameter of that tank.

Setting-up Procedure for “Horizontal Cyl Flat”:

1. Use the Tank Shape/NLP (P011) parameter to select “Horizontal Cyl Flat”.
2. Enter the full volume into the PV Scale Factor parameter ([page 154](#)).
3. Enter the tank diameter into the Profile Height / Power Factor parameter ([page 156](#)).

Tank Shape/NLP (P011) = “Spherical”

This setting is applicable when volume measurements are needed from a spherical tank with a constant diameter (see [Figure F-5](#) on [page 148](#) for a cross-sectional view).

The volume is calculated from the liquid level measurement and the full volume of the ideal spherical tank.

Setting-up Procedure for “Spherical”:

1. Use the Tank Shape/NLP (P011) parameter to select “Spherical”.
2. Enter the full volume into the PV Scale Factor parameter ([page 154](#)).
3. Enter the tank diameter into the Profile Height / Power Factor parameter ([page 156](#)).

Figure F-5. Cylindrical or Spherical Tank Cross-section

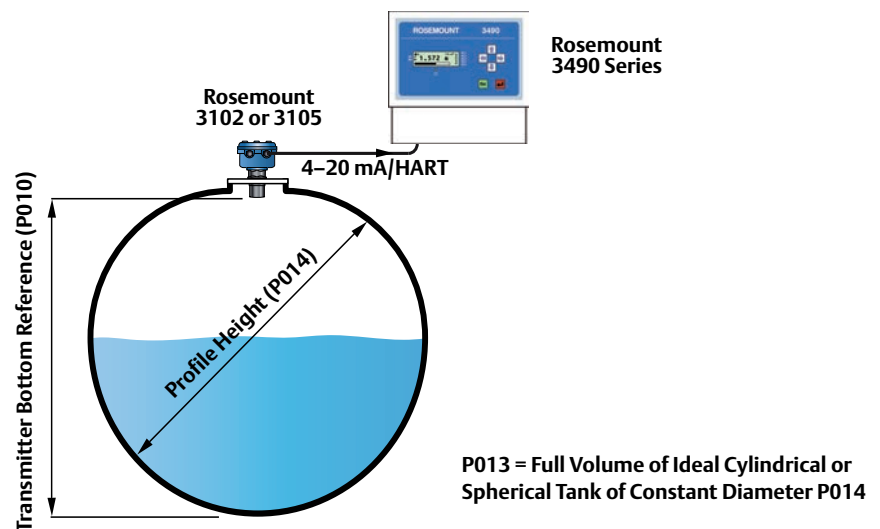

Tank Shape/NLP (P011) = “Horizontal Cyl Dome”

This Horizontal Cylinder With Domed Ends setting is applicable when volume measurements are needed from a horizontally-oriented cylindrical tank with a constant diameter (see [Figure F-5](#) for a cross-sectional view).

The volume is calculated from the live level measurement, the full volume of an ideal cylindrical tank, and the diameter of that tank.

Setting-up Procedure for “Horizontal Cyl Dome”:

1. Use the Tank Shape/NLP (P011) parameter to select “Horizontal Cyl Dome”.
2. Enter the full volume into the PV Scale Factor parameter ([page 154](#)).
3. Enter the tank diameter into the Profile Height / Power Factor parameter ([page 156](#)).

F.3.13 Flow measurement

Table F-1 on page F-152 lists the Tank Shape/Non-Linear Profile (P011) options that select a standard flow structure profile and the conversion (scale) factors used to calculate a flow process value (PV).

Tank Shape/NLP (P011) = “Special Plot”

The “**Special Plot**” option is used for *irregular-shaped* flow profiles. See page 145 for a full description.

Tank Shape/NLP (P011) = “Flume/Weir-3/2”

This setting is applicable when flow rate measurements are needed from an open channel with a flume or weir profile (see Figure F-6).

Flumes that deviate from the standard “3/2 power law”, e.g. round-bottomed flumes, must use the “Special Plot” profile option that is based on flow versus height tabulations (see page 145).

Setting-up procedure for “Flume/Weir-3/2”:

1. Use parameter Tank Shape/NLP (P011) to select “Flume/Weir-3/2”.
The transmitter will then automatically populate the parameter Power Factor (page 156) with a power factor from Table F-1.
2. Enter a scale factor into the PV Scale Factor parameter (page 154).

Figure F-6. Rectangular Weir Cross-section

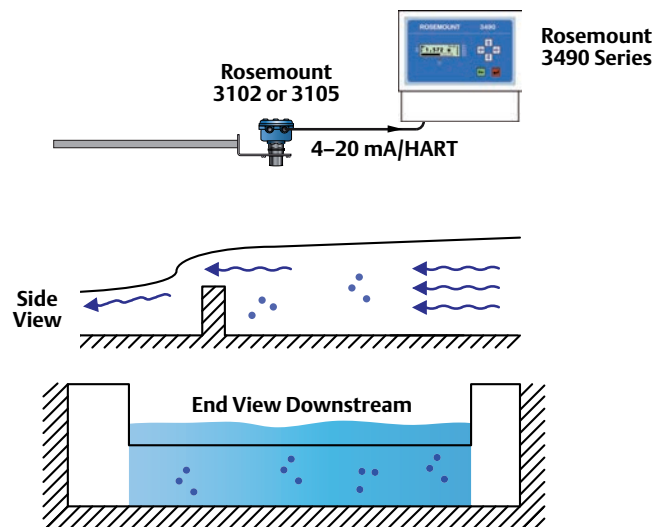

Tank Shape/NLP (P011) = “V-Notch-5/2”

This setting is applicable when flow measurements are needed from an open channel with a V-notch profile (see Figure F-7).

Setting-up procedure for “V-Notch-5/2”

1. Edit parameter Tank Shape/NLP (P011) to select “V-Notch-5/2”.
The transmitter will then automatically populate the parameter Power Factor (page 156) with a power factor from Table F-1.
2. Enter a scale factor into the PV Scale Factor parameter (page 154).

Figure F-7. V-Notch Cross-section

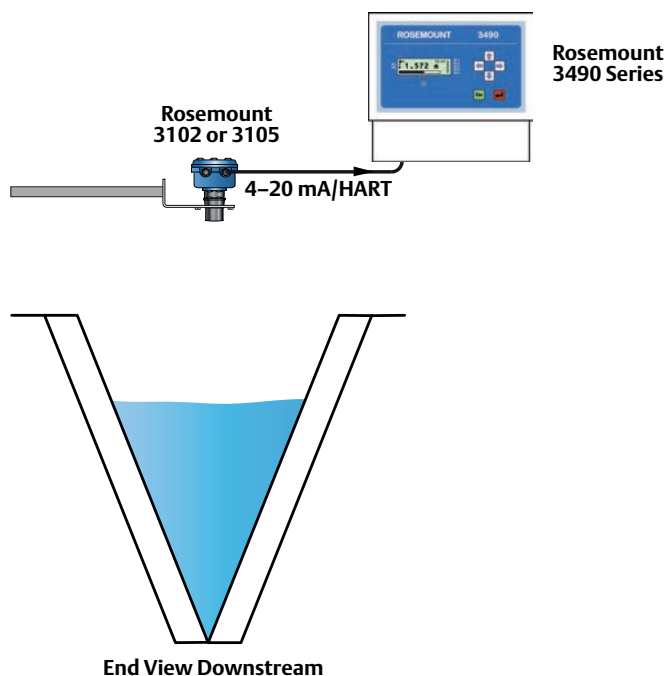

Table F-1. Standard Flow Profile Options

Options	Flow Structures	Hmax		Scale Factor		Power Factor	20 mA Point ⁽¹⁾	
		(m)	(ft./in.)	(m ³ /hour) ⁽²⁾	(GPM) ⁽²⁾		(m)	(ft./in.)
3/2	Flume 3/2 flow law	N/A	N/A	(User) ⁽³⁾	(User) ⁽³⁾	1.5	(User) ⁽³⁾	(User) ⁽³⁾
5/2	V-Notch 5/2 flow law	N/A	N/A	(User) ⁽³⁾	(User) ⁽³⁾	2.5	(User) ⁽³⁾	(User) ⁽³⁾
mann	Manning formula	N/A	N/A	(User) ⁽³⁾	(User) ⁽³⁾	(User) ⁽³⁾	N/A	N/A
PAr01	1-in. Parshall flume	0.75	2.5	217.3	151.7	1.55	17.9	87.3
PAr02	2-in. Parshall flume	0.75	2.5	434.6	303.4	1.55	50.7	215
PAr03	3-in. Parshall flume	0.75	2.5	635.5	445.2	1.547	125	516
PAr06	6-in. Parshall flume	0.75	2.5	1372	924.5	1.58	389	1750
PAr09	9-in. Parshall flume	0.75	2.5	1927	1378	1.53	882	3980
PAr1	1-ft. Parshall flume	0.75	2.5	2487	1795	1.522	1610	7240
PAr1.5	1 ¹ / ₂ -ft. Parshall flume	0.75	2.5	3803	2693	1.538	2440	11000
PAr2	2-ft. Parshall flume	0.75	2.5	5143	3590	1.550	3290	14900
PAr3	3-ft. Parshall flume	0.75	2.5	7863	5386	1.566	5010	22600
PAr4	4-ft. Parshall flume	0.75	2.5	10630	7181	1.578	6750	30500
PAr5	5-ft. Parshall flume	0.75	2.5	13440	8976	1.587	8510	38400
PAr6	6-ft. Parshall flume	0.75	2.5	16280	10770	1.595	10300	46400
PAr8	8-ft. Parshall flume	0.75	2.5	22010	14360	1.607	13900	62600
PAr10	10-ft. Parshall flume	0.75	2.5	26862	17672	1.6	20700	89200
FF01 ⁽⁴⁾	Flume Flat 1 (m)	0.102	N/A	0.135	N/A	1.5	9	N/A
FF02 ⁽⁴⁾	Flume Flat 2 (m)	0.191	N/A	0.178	N/A	1.5	36	N/A
FF03 ⁽⁴⁾	Flume Flat 3 (m)	0.267	N/A	0.313	N/A	1.5	90	N/A
FF04 ⁽⁴⁾	Flume Flat 4 (m)	0.406	N/A	0.542	N/A	1.5	360	N/A
FF05 ⁽⁴⁾	Flume Flat 5 (m)	0.635	N/A	0.811	N/A	1.5	900	N/A
FF06 ⁽⁴⁾	Flume Flat I	0.200	N/A	0.132	N/A	1.5	30	N/A
FF07 ⁽⁴⁾	Flume Flat II	0.250	N/A	0.178	N/A	1.5	60	N/A
FF08 ⁽⁴⁾	Flume Flat III	0.300	N/A	0.218	N/A	1.5	90	N/A
FF09 ⁽⁴⁾	Flume Flat III bis	0.3333	N/A	0.328	N/A	1.5	200	N/A
FF10 ⁽⁴⁾	Flume Flat III ter	0.400	N/A	0.272	N/A	1.5	200	N/A
FF11 ⁽⁴⁾	Flume Flat IV	0.400	N/A	0.352	N/A	1.5	180	N/A
FF12 ⁽⁴⁾	Flume Flat V	0.500	N/A	0.443	N/A	1.5	360	N/A
FF13 ⁽⁴⁾	Flume Flat V bis	0.400	N/A	0.401	N/A	1.5	320	N/A
FF14 ⁽⁴⁾	Flume Flat VI	0.540	N/A	0.499	N/A	1.5	720	N/A
FF15 ⁽⁴⁾	Flume Flat VII	0.700	N/A	0.624	N/A	1.5	1080	N/A
FF16 ⁽⁴⁾	Flume Flat VIII	0.600	N/A	0.881	N/A	1.5	1440	N/A
FF17 ⁽⁴⁾	Flume Flat VIII bis	0.666	N/A	0.798	N/A	1.5	1500	N/A
FF18 ⁽⁴⁾	Flume Flat IX	0.800	N/A	1.065	N/A	1.5	1800	N/A
FF19 ⁽⁴⁾	Flume Flat IX bis	0.733	N/A	0.815	N/A	1.5	1700	N/A
FF20 ⁽⁴⁾	Flume Flat X	0.867	N/A	1.322	N/A	1.5	3600	N/A
FF21 ⁽⁴⁾	Flume Flat X bis	1.200	N/A	1.609	N/A	1.5	7500	N/A
FF22 ⁽⁴⁾	Flume Flat X ter	0.959	N/A	1.065	N/A	1.5	3500	N/A
FF23 ⁽⁴⁾	Flume Flat XI	1.200	N/A	1.651	N/A	1.5	7200	N/A
FP01 ⁽⁴⁾	Flume Parabolic 1	0.200	N/A	0.399	N/A	2.3	20	N/A
FP02 ⁽⁴⁾	Flume Parabolic 2	0.250	N/A	0.442	N/A	2.3	40	N/A
FP03 ⁽⁴⁾	Flume Parabolic 3	0.310	N/A	0.464	N/A	2.2	90	N/A
FP04 ⁽⁴⁾	Flume Parabolic 4	0.380	N/A	0.544	N/A	2.2	180	N/A
FP05 ⁽⁴⁾	Flume Parabolic 5	0.460	N/A	0.619	N/A	2.1	360	N/A
FP06 ⁽⁴⁾	Flume Parabolic 6	0.600	N/A	0.717	N/A	2.1	720	N/A
FP07 ⁽⁴⁾	Flume Parabolic 7	0.800	N/A	0.772	N/A	2.1	1400	N/A

(1) Where entries do not say "(User)", the 20 mA Point (Upper Range Value) is automatically set to the value in the meters (m) or feet/inches (ft./in.) column depending on the selected Base Units. The 4 mA Point (Lower Range Value) is automatically set to 0.

(2) If the Base Units are meters (m), the flow units are m³/hour. Otherwise, flow units are gal/m (GPM). The gallons are US gallons.

(3) Where shown, "(User)" indicates that the user is required to input the appropriate data.

(4) FF and FP flume options require the Base Units to be meters (m). See "Changing the base units (on the 3102/3105)" on page 74 if a change of Base Units is required.

F.3.14 Primary variable units (P012)

Fast Keys	2, 2, 3, 1
------------------	------------

This selects alternative display units for the HART Primary Variable (PV), which are then reported to a HART Master Device such as a Rosemount 3490 Series Control Unit.

Note

Selecting alternative display units does not automatically re-scale the PV value. Use the parameter PV Scale Factor (page 154) to manually re-scale the value.

Field Communicator or AMS Device Manager

To view or change the displayed units for the PV

- From the *Home* screen, select 2: Configure.
- Select 2: Manual Setup.
- Select 3: Profiling.
- Select 1: Primary Variable Units P012.
- If a change is required:
 - Select new units, and then select “ENTER” to save the selection.
 - Select “Send” or “Apply” to update the transmitter.

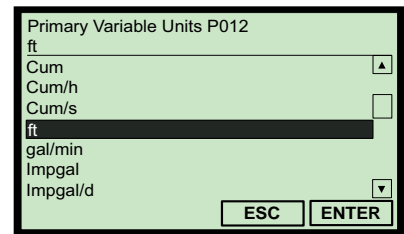

(Field Communicator Screen Shown)

Note

If the HART PV has no units, select and confirm the “None”, “Unknown”, or “Not Used” option as appropriate for the HART Master Device (host).

Rosemount 3490 Series Control Unit

To view or change the displayed units for the PV

- From the *Main Menu* screen, select SETUP.
- Select the transmitter (e.g. “Tx1: 3102”).
- Select UNITS.
- Select PV Units.
- Follow the on-screen instructions to select and confirm the new setting. If the HART PV has no units, select and confirm the “None” option. (Use the Enter (↵) key if prompted to change mode to “off-line”).
- Select “Quit” to exit to the previous menu.

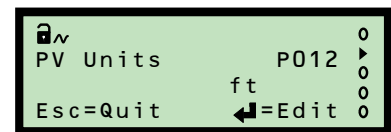

(Rosemount 3491 Screen Shown)

F.3.15 Scale factor / k-factor (P013)

Fast Keys	2, 2, 3, 4
-----------	------------

Level measurement use of P013

When the process value (PV) is a level measurement in meters, feet, or inches, this parameter converts (scales) the level measurement into alternative units before being output. Enter a value of 1.0 if alternative units are not required.

Volume measurement use of P013

When the PV is a volume measurement from a *standard non-linear-shaped* tank e.g. cylinder or sphere, use this parameter to enter the volume of the ideal shaped tank (see [Figure F-5 on page 148](#)).

When the PV is a volume measurement from a *regular-shaped* tank e.g. square or rectangular, use this parameter to enter the volume change per unit of the base unit.

When the PV is a volume measurement from an *irregular-shaped* tank, use this parameter to enter the maximum volume. See also the Special Plot section on [page 145](#) for defining the *irregular-shaped* tank.

Open channel measurement use of P013

When the PV is the flow rate in a *standard* open channel, use this parameter to enter the scale factor ('k' term) in a flow rate calculation. See "[Flow measurement](#)" on [page 150](#) for selecting a standard flow profile.

When the PV is the flow rate in an *irregular-shaped* open channel, use this parameter to enter the maximum flow rate. See also the Special Plot section on [page 150](#) for defining the *irregular-shaped* channel.

Field Communicator or AMS Device Manager

To view or change the scale factor / k-factor

1. From the *Home* screen, select 2: Configure.
2. Select 2: Manual Setup.
3. Select 3: Profiling.
4. Select 4: Scale Factor P013 or 4: k-factor P013, depending on the non-linear profile selected (see [page 138](#)).
5. If a change is required:
 - (a) Input the new factor, and select "ENTER" to save it.
 - (b) Select "Send" or "Apply" to update the transmitter.

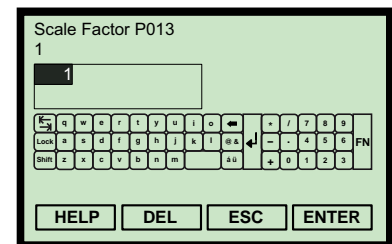

(Field Communicator Screen Shown)

Rosemount 3490 Series Control Unit

To view or change the scale factor / k-factor

1. From the *Main Menu* screen, select SETUP.
2. Select the transmitter (e.g. "Tx1: 3102").
3. Select DUTY.
4. Select PV Scale Factor.
5. Follow the on-screen instructions to edit and save the new setting. (Use the Enter (↵) key if prompted to change mode to "off-line").
6. Select "Quit" to exit to the previous menu.

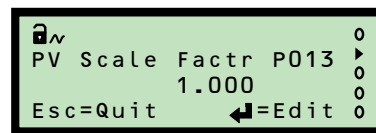

(Rosemount 3491 Screen Shown)

F.3.16 Profile height / power factor (P014)

Fast Keys	2, 2, 3, 5
-----------	------------

Level measurement use of P014

This is not used for level measurements. It does not appear on the Field Communicator unless required for volume or flow measurements.

Volume measurement use of P014

When the process value (PV) is a volume measurement from a *standard non-linear-shaped* tank e.g. an ideal horizontal cylinder or a sphere, use this parameter to enter the diameter (see [Figure F-5 on page 148](#)).

When the PV is a volume measurement from a *regular-shaped* tank e.g. square or rectangular, this parameter is not used.

When the PV is a volume measurement from an *irregular-shaped* tank, use this parameter to enter the maximum height (see [page 145](#)). See also the Special Plot section on [page 145](#) for defining the *irregular-shaped* tank.

Open channel measurement use of P014

When the process value (PV) is a flow rate in a *standard* open channel, this parameter is used as the power factor ('pwr' term) in a flow rate calculation (see "[Flow measurement](#)" on [page 150](#)).

When the PV is the flow rate in an *irregular-shaped* open channel, use this parameter to enter the maximum height (see [page 145](#)). See also the Special Plot section on [page 150](#) for defining the *irregular-shaped* channel.

Field Communicator or AMS Device Manager

To view or change the diameter, maximum height, or power factor

1. From the *Home* screen, select 2: Configure.
2. Select 2: Manual Setup.
3. Select 3: Profiling.
4. Select 5: Non-Linear Profile Height P014 or 5: Power Factor P014 depending on the non-linear profile selected (see [page 138](#)).
5. If a change is required:
 - (a) Input a new value, and select "ENTER" to save it.
 - (b) Select "Send" or "Apply" to update the transmitter.

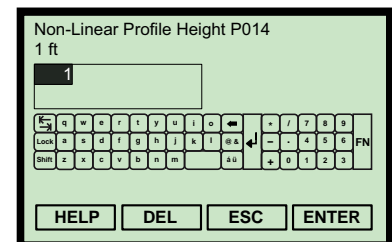

(Field Communicator Screen Shown)

Rosemount 3490 Series Control Unit

To view or change the diameter, maximum height, or power factor

1. From the *Main Menu* screen, select SETUP.
2. Select the transmitter (e.g. "Tx1: 3102").
3. Select DUTY.
4. Select Profile Height.
5. Follow the on-screen instructions to edit and save the new setting. (Use the Enter (↵) key if prompted to change mode to "off-line").
6. Select "Quit" to exit to the previous menu.

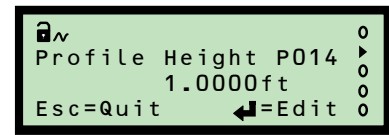

(Rosemount 3491 Screen Shown)

F.3.17 Profile points 1 to 10 (P030 to P039)

Fast Keys	2, 2, 3, 6
------------------	------------

These parameters are used to define an irregular-shaped profile for calculating the process value (PV) from a live level reading. They are only used if Tank Shape P011 is set to Special Plot.

Note

See [page 145](#) for examples of how these parameters are used.

Field Communicator or AMS Device Manager

To view or change the profile point

1. From the *Home* screen, select 2: Configure.
2. Select 2: Manual Setup.
3. Select 3: Profiling.
4. Select 6: Plot Non-Linear Profile Points.
5. Select a profile point e.g. 1: Profile Point1 P030.
6. If a change is required:
 - (a) Input a new value, and then select “ENTER” to save it.
 - (b) Select “Send” or “Apply” to update the transmitter.

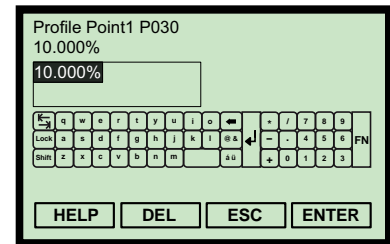

(Field Communicator Screen Shown)

Note

The profile point parameters are only accessible on a Field Communicator if they are required for a selected Non-linear Profile (see [page 138](#)). The points can be changed only if the “Special Plotted” profile has been selected (see [page 143](#)).

Rosemount 3490 Series Control Unit

To view or change the profile point

1. From the *Main Menu* screen, select SETUP.
2. Select the transmitter (e.g. “Tx1: 3102”).
3. Select DUTY.
4. Select NLP CURVE.
5. Select a profile point e.g. “Profile Pt. 1”.
6. Follow the on-screen instructions to edit and save the new setting. (Use the Enter (↵) key if prompted to change mode to “off-line”).
7. Select “Quit” to exit to the previous menu.

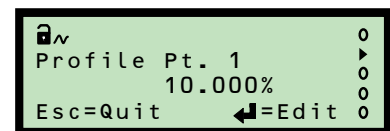

(Rosemount 3491 Screen Shown)

F.3.18 Upper range value (P015)

Fast Keys	2, 2, 1, 3
-----------	------------

This defines the process value (PV) represented by a 20 mA output from the transmitter.

The span of the 4–20 mA current output is defined by the Upper Range Value parameter and the Lower Range Value parameter (page 160).

As an example, consider a tank with a 120 gallons capacity. When full, a 20 mA output current is required from the transmitter. Therefore, the upper range value is set to 120 if the PV is in gallon units. The lower range value is typically set to 0 (gallons) for the 4 mA output to indicate an empty tank.

The upper range value can be less than the lower range value, in which case the current output will decrease for an increasing process value (PV).

Note

The upper range value is *automatically overwritten* when the Tank Shape/NLP parameter is used to select a flume flow profile, but the populated value can still be edited if required. See Table F-1 on page F-152 for the 20 mA point values.

Note

The displayed units are selected using the parameter Primary Variable Units (page 153). Changing units does not re-scale the upper range value.

Field Communicator or AMS Device Manager

To view or change the upper range value

1. From the *Home* screen, select 2: Configure.
2. Select 2: Manual Setup.
3. Select 1: Basic Setup.
4. Select 3: Upper Range Value P015.
5. If a change is required:
 - (a) Input a new value, and then select “ENTER” to save it.
 - (b) Select “Send” or “Apply” to update the transmitter.

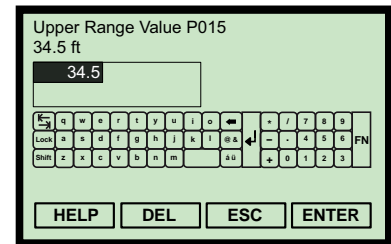

(Field Communicator Screen Shown)

Note

When messages appear, take appropriate action if needed and select “OK”.

Rosemount 3490 Series Control Unit

To view or change the upper range value

1. From the *Main Menu* screen, select SETUP.
2. Select the transmitter (e.g. “Tx1: 3102”).
3. Select OUTPUT.
4. Select CURRENT.
5. Select Up Range Val.
6. Follow the on-screen instructions to edit and save the new setting. (Use the Enter (↵) key if prompted to change mode to “off-line”).
7. Select “Quit” to exit to the previous menu.

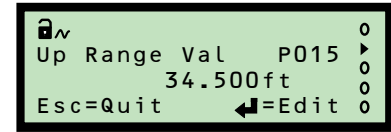

(Rosemount 3491 Screen Shown)

F.3.19 Lower range value (P016)

Fast Keys	2, 2, 1, 4
-----------	------------

This defines the process value (PV) represented by a 4 mA output from the transmitter.

The span of the 4–20 mA current output is defined by the Upper Range Value parameter ([page 159](#)) and the Lower Range Value parameter.

As an example, consider a tank with a 120 gallons capacity. When empty, a 4 mA output current is required from the transmitter. Therefore, the lower range value is set to 0. The upper range value is typically set to 120 (gallons) for the 20 mA output current to indicate an full tank.

The lower range value can be greater than the upper range value, in which case the current output will decrease for an increasing process value (PV).

Note

The displayed units are selected using the parameter Primary Variable Units ([page 153](#)). Changing units does not re-scale the lower range value.

Field Communicator or AMS Device Manager

To view or change the lower range value

1. From the *Home* screen, select 2: Configure.
2. Select 2: Manual Setup.
3. Select 1: Basic Setup.
4. Select 4: Lower Range Value P016.
5. If a change is required:
 - (a) Input a new value, and then select “ENTER” to save it.
 - (b) Select “Send” or “Apply” to update the transmitter.

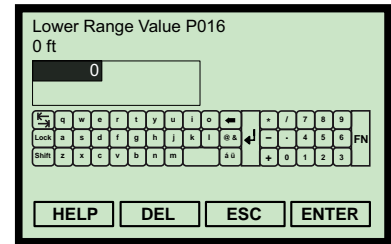

(Field Communicator Screen Shown)

Note

When messages appear, take appropriate action if needed and select “OK”.

Rosemount 3490 Series Control Unit

To view or change the lower range value

1. From the *Main Menu* screen, select SETUP.
2. Select the transmitter (e.g. “Tx1: 3102”).
3. Select OUTPUT.
4. Select CURRENT.
5. Select Low Range Val.
6. Follow the on-screen instructions to input and save the new setting. (Use the Enter (↵) key if prompted to change mode to “off-line”).
7. Select “Quit” to exit to the previous menu.

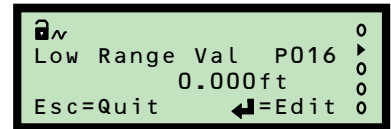

(Rosemount 3491 Screen Shown)

F.3.20 Damping (P020)

Fast Keys	2, 2, 1, 5
-----------	------------

The damping value is a time constant in seconds, and is applied as smoothing to the level reading and the output current.

A larger value will have the effect of smoothing out rapid changes of level, and smooth out the effects of turbulence and ripples on the liquid surface.

A value of zero can be edited, in which case no smoothing is applied and transmitter readings immediately change the output. However, this may result in a rather ‘noisy’ output and is not normally recommended.

Note

The pulse repetition frequency of the transmitter is one pulse per second, which means that the system response time cannot be faster than this.

Field Communicator or AMS Device Manager

To view or change the damping

1. From the *Home* screen, select 2: Configure.
2. Select 2: Manual Setup.
3. Select 1: Basic Setup.
4. Select 5: Damping P020.
5. If a change is required:
 - (a) Input a new value, and then select “ENTER” to save it.
 - (b) Select “Send” or “Apply” to update the transmitter.

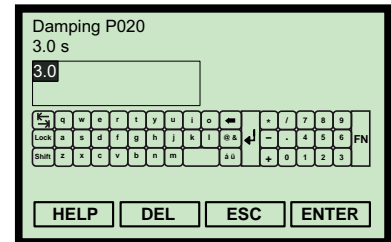

(Field Communicator Screen Shown)

Note

When messages appear, take appropriate action if needed and select “OK”.

Rosemount 3490 Series Control Unit

To view or change the damping

1. From the *Main Menu* screen, select SETUP.
2. Select the transmitter (e.g. “Tx1: 3102”).
3. Select OUTPUT.
4. Select CURRENT.
5. Select Damping.
6. Follow the on-screen instructions to edit and save the new setting. (Use the Enter (↵) key if prompted to change mode to “off-line”).
7. Select “Quit” to exit to the previous menu.

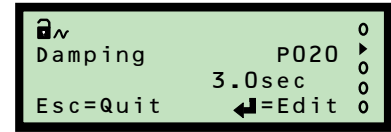

(Rosemount 3491 Screen Shown)

F.3.21 Relay 1 mode (P070) on the Rosemount 3102

Fast Keys	2, 2, 4, 1, 1
-----------	---------------

On the Rosemount 3102, RL1 is factory-set to be a *control relay*. It may be set to energize when the PV reaches a value set by RL1 PV On Point (P071), and de-energize when it reaches a value set by RL1 PV Off Point (P072).

RL1 mode can be changed to a fault relay by selecting “Fault”. In this mode, it de-energizes under Lost Echo (LE) or fault conditions. The relay de-energizes if the power fails.

Note

The relay RL1 is switched off by selecting “Setpoint” and then setting the *on* and *off* points to an identical process value.

Field Communicator or AMS Device Manager

To view or change the damping

1. From the *Home* screen, select 2: Configure.
2. Select 2: Manual Setup.
3. Select 4: Relay Output
4. Select 1: Relay 1
5. Select 1: Relay 1 Mode P070
6. If a change is required:
 - (a) Select new mode, and then select “ENTER” to save the selection.
 - (b) Select “Send” or “Apply” to update the transmitter.

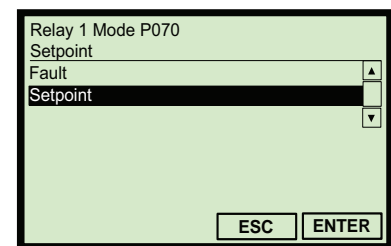

(Field Communicator Screen Shown)

Note

When messages appear, take appropriate action if needed and select “OK”.

Rosemount 3490 Series Control Unit

To view or change the damping

1. From the *Main Menu* screen, select SETUP.
2. Select the transmitter (e.g. “Tx1: 3102”).
3. Select OUTPUT, and then select RELAYS.
4. Select Relay 1, and then select Relay 1 Mode.
5. Follow the on-screen instructions to edit and save the new setting.
(Use the Enter (↵) key if prompted to change mode to “off-line”).
6. Select “Quit” to exit to the previous menu.



(Rosemount 3491 Screen Shown)

F.3.22 RL1 PV on point (P071) on the Rosemount 3102

Fast Keys	2, 2, 4, 1, 2
------------------	---------------

When relay RL1 is a control relay (default mode), this parameter defines the set-point where RL1 energizes.

The set-point where RL1 de-energizes is defined by RL1 PV Off Point (P072).

All relay set-point values must be entered in the units selected for the PV. The *on* point value may be greater or smaller than the *Off* point value.

Field Communicator or AMS Device Manager

To view or change the damping

- From the *Home* screen, select 2: Configure.
- Select 2: Manual Setup.
- Select 4: Relay Output.
- Select 1: Relay 1.
- Select 2: RL1 PV On Point P071.
- If a change is required:
 - Input a new value, and then select “ENTER” to save it.
 - Select “Send” or “Apply” to update the transmitter.

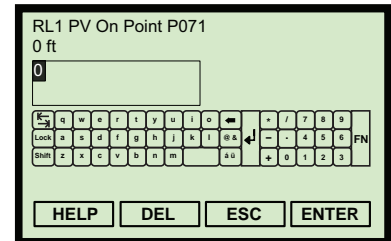

(Field Communicator Screen Shown)

Note

When messages appear, take appropriate action if needed and select “OK”.

Rosemount 3490 Series Control Unit

To view or change the damping

- From the *Main Menu* screen, select SETUP.
- Select the transmitter (e.g. “Tx1: 3102”).
- Select OUTPUT.
- Select RELAYS.
- Select Relay 1.
- Select RL1 On Point.
- Follow the on-screen instructions to select the new mode. (Use the Enter (↵) key if prompted to change mode to “off-line”).
- Select “Quit” to exit to the previous menu.

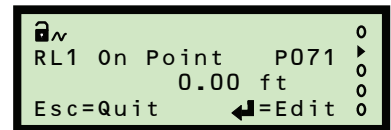

(Rosemount 3491 Screen Shown)

F.3.23 RL1 PV off point (P072) on the Rosemount 3102

Fast Keys	2, 2, 4, 1, 3
------------------	---------------

When relay RL1 is a control relay (default mode), this parameter defines the set-point where RL1 de-energizes.

The set-point where RL1 energizes is defined by RL1 PV On Point (P071).

All relay set-point values must be entered in the units selected for the PV. The *on* point value may be greater or smaller than the *off* point value.

Field Communicator or AMS Device Manager

To view or change the damping

1. From the *Home* screen, select 2: Configure.
2. Select 2: Manual Setup.
3. Select 4: Relay Output.
4. Select 1: Relay 1.
5. Select 3: RL1 PV Off Point P072.
6. If a change is required:
 - (a) Input a new value, and then select “ENTER” to save it.
 - (b) Select “Send” or “Apply” to update the transmitter.

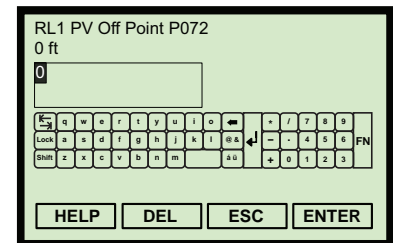

(Field Communicator Screen Shown)

Note

When messages appear, take appropriate action if needed and select “OK”.

Rosemount 3490 Series Control Unit

To view or change the damping:

1. From the *Main Menu* screen, select SETUP.
2. Select the transmitter (e.g. “Tx1: 3102”).
3. Select OUTPUT, and then select RELAYS.
4. Select Relay 1, and then select RL1 Off Point.
5. Follow the on-screen instructions to select the new mode. (Use the Enter (↵) key if prompted to change mode to “off-line”).
6. Select “Quit” to exit to the previous menu.

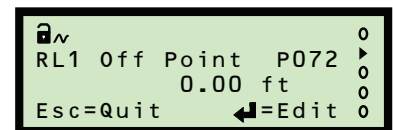

(Rosemount 3491 Screen Shown)

F.3.24 Relay 2 mode (P073) on the Rosemount 3102

Fast Keys	2, 2, 4, 2, 1
------------------	---------------

On the Rosemount 3102, RL2 is factory-set to be a *fault relay*. In this mode, it de-energizes under Lost Echo (LE) or fault conditions. The relay de-energizes if the power fails.

The RL2 mode of may be changed to control mode by selecting “Setpoint” and then entering RL2 PV On Point (P074) and RL2 PV Off Point (P075) values. All relay set-point values must be entered in the PV units.

The *on* point value may be greater or smaller than the *off* point value.

Note

The relay RL2 is switched off by selecting “Setpoint” and then setting the On and Off points to an identical process value.

Field Communicator or AMS Device Manager

To view or change the damping

1. From the *Home* screen, select 2: Configure.
2. Select 2: Manual Setup.
3. Select 4: Relay Output.
4. Select 2: Relay 2, and then select 1: Relay 2 Mode P073.
5. If a change is required:
 - (a) Select new mode, and then select “ENTER” to save the selection.
 - (b) Select “Send” or “Apply” to update the transmitter.

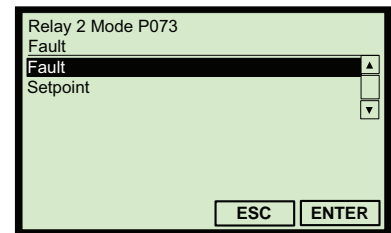

(Field Communicator Screen Shown)

Note

When messages appear, take appropriate action if needed and select “OK”.

Rosemount 3490 Series Control Unit

To view or change the damping

1. From the *Main Menu* screen, select SETUP.
2. Select the transmitter (e.g. “Tx1: 3102”).
3. Select OUTPUT, and then select RELAYS.
4. Select Relay 2, and then select Relay 2 Mode.
5. Follow the on-screen instructions to select the new mode. (Use the Enter (↵) key if prompted to change mode to “off-line”).
6. Select “Quit” to exit to the previous menu.

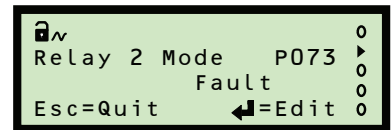

(Rosemount 3491 Screen Shown)

F.3.25 RL2 PV on point (P074) on the Rosemount 3102

Fast Keys	2, 2, 4, 2, 2
------------------	---------------

When relay RL2 is changed from a fault relay (default mode) to a control relay, this parameter defines the set-point where RL2 energizes.

The set-point where RL2 de-energizes is defined by RL2 PV Off Point (P075).

All relay set-point values must be entered in the units selected for the PV. The “On” point value may be greater or smaller than the “Off” point value.

Field Communicator or AMS Device Manager

To view or change the damping:

1. From the *Home* screen, select 2: Configure.
2. Select 2: Manual Setup.
3. Select 4: Relay Output.
4. Select 2: Relay 2.
5. Select 2: RL2 PV On Point P074.
6. If a change is required:
 - (a) Input a new value, and then select “ENTER” to save it.
 - (b) Select “Send” or “Apply” to update the transmitter.

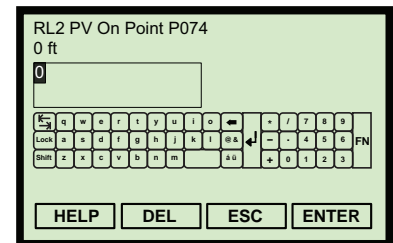

(Field Communicator Screen Shown)

Note

When messages appear, take appropriate action if needed and select “OK”.

Rosemount 3490 Series Control Unit

To view or change the damping

1. From the *Main Menu* screen, select SETUP.
2. Select the transmitter (e.g. “Tx1: 3102”).
3. Select OUTPUT, and then select RELAYS.
4. Select Relay 2, and then select RL2 On Point.
5. Follow the on-screen instructions to select the new mode. (Use the Enter (↵) key if prompted to change mode to “off-line”).
6. Select “Quit” to exit to the previous menu.

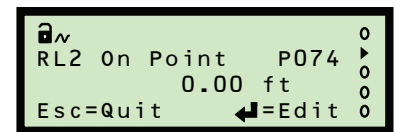

(Rosemount 3491 Screen Shown)

F.3.26 RL2 PV off point (P075) on the Rosemount 3102

Fast Keys	2, 2, 4, 2, 3
------------------	---------------

When relay RL2 is changed from a fault relay (default mode) to a control relay, this parameter defines the set-point where RL2 de-energizes.

The set-point where RL2 energizes is defined by RL2 PV On Point (P074).

All relay set-point values must be entered in the units selected for the PV. The *on* point value may be greater or smaller than the *off* point value.

Field Communicator or AMS Device Manager

To view or change the damping

- From the *Home* screen, select 2: Configure.
- Select 2: Manual Setup.
- Select 4: Relay Output.
- Select 2: Relay 2.
- Select 3: RL2 PV Off Point P075.
- If a change is required:
 - Input a new value, and then select “ENTER” to save it.
 - Select “Send” or “Apply” to update the transmitter.

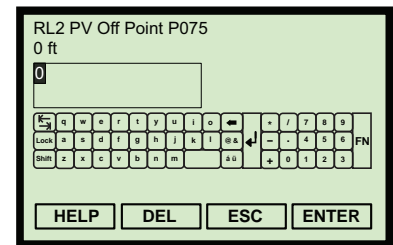

(Field Communicator Screen Shown)

Note

When messages appear, take appropriate action if needed and select “OK”.

Rosemount 3490 Series Control Unit

To view or change the damping

- From the *Main Menu* screen, select SETUP.
- Select the transmitter (e.g. “Tx1: 3102”).
- Select OUTPUT, and then select RELAYS.
- Select Relay 2, and then select RL2 Off Point.
- Follow the on-screen instructions to select the new mode. (Use the Enter (↵) key if prompted to change mode to “off-line”).
- Select “Quit” to exit to the previous menu.

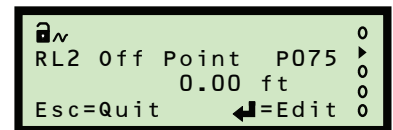

(Rosemount 3491 Screen Shown)

F.3.27 Lost echo delay (P021)

Fast Keys	2, 2, 5 [or 6], 1
-----------	-------------------

In pulse echo level measurement systems, ultrasonic pulse echoes are sometimes lost due to adverse liquid surface conditions such as turbulence or foam. The ultrasonic pulse transmitted towards the surface is sometimes not returned, deflected away from the transmitter, or attenuated significantly. In these conditions, the transmitter holds the last valid data and transmits another pulse to see if the echo is returned.

Lost Echo Delay (P021) defines the period that the transmitter will hold and display the present valid surface measurement, waiting to update the measurement when the echo is recovered.

A “lost echo” fault condition is signalled if the Lost Echo Delay period ends with no valid echoes returned.

A valid returned echo occurs inside a 'window' on either side of the liquid level. The 'window' increases as the range to the target increases. All echoes within the 'window' are monitored and averaged to smooth of the liquid level output under turbulent conditions.

Any returned echo from closer than the liquid surface is considered valid if a minimum required number of echoes (page 180) have been received. The output will then change to this new value.

Any echo returned further than the liquid surface and outside the 'window' is ignored. However, if a lost echo condition is developing and a period (Lost Echo Delay divided by two⁽¹⁾) has elapsed, any echoes received from further away targets are treated as valid. The liquid level measured changes to the new value after receiving four such echoes.

Field Communicator or AMS Device Manager

To view or change the lost echo delay

1. From the *Home* screen, select 2: Configure.
2. Select 2: Manual Setup
3. Select 5: Engineering (3105) or 6: Engineering (3102).
4. Select 1: Lost Echo Delay P021.
5. If a change is required:
 - (a) Input a new value, and then select “ENTER” to save it.
 - (b) Select “Send” or “Apply” to update the transmitter.

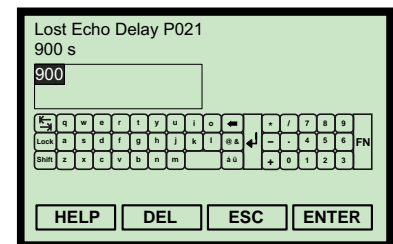

(Field Communicator Screen Shown)

Note

When messages appear, take appropriate action if needed and select “OK”.

(1) Maximum of 20 seconds.

Rosemount 3490 Series Control Unit

To view or change the lost echo delay

1. From the *Main Menu* screen, select SETUP.
2. Select the transmitter (e.g. "Tx1: 3102").
3. Select ENGINEERING, and then select LE Delay.
4. Follow the on-screen instructions to edit and save the new setting. (Use the Enter (↵) key if prompted to change mode to "off-line").
5. Select "Quit" to exit to the previous menu.

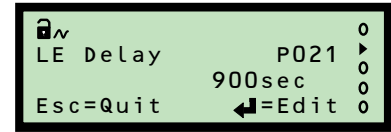

(Rosemount 3491 Screen Shown)

F.3.28 Lost echo action (P022)

Fast Keys	2, 2, 5 [or 6], 2
-----------	-------------------

This defines what happens to the process value (PV) and output current when a “lost echo” condition exists (see [page 170](#)).

“MINIMUM” action

The PV is forced to zero while a “lost echo” condition exists.

In addition, the two-wire loop current changes to indicate this condition (see ["Selecting the Lost Echo action \(on the 3102/3105\)" on page 51](#)). The current remains at that level until the correct target echo is recovered.

“MAXIMUM” action

The PV is forced to the maximum while a “lost echo” condition exists. The maximum PV is the value that occurs when an echo is received from the transmitter face.

In addition, the two-wire loop current changes to indicate this condition (see ["Selecting the Lost Echo action \(on the 3102/3105\)" on page 51](#)). The current remains at that level until the correct target echo is recovered.

“HOLD” action

The current output is held at the last good PV value.

Field Communicator or AMS Device Manager

To view or change the lost echo action

1. From the *Home* screen, select 2: Configure.
2. Select 2: Manual Setup.
3. Select 5: Engineering (3105) or 6: Engineering (3102).
4. Select 2: Lost Echo Action P022.
5. If a change is required:
 - (a) Select a new action, and then select “ENTER” to save it.
 - (b) Select “Send” or “Apply” to update the transmitter.

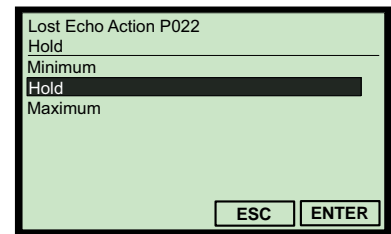

(Field Communicator Screen Shown)

Note

When messages appear, take appropriate action if needed and select “OK”.

Rosemount 3490 Series Control Unit

To view or change the lost echo action

1. From the *Main Menu* screen, select SETUP.
2. Select the transmitter (e.g. "Tx1: 3102").
3. Select ENGINEERING.
4. Select LE Action.
5. Follow the on-screen instructions to edit and save the new setting. (Use the Enter (↵) key if prompted to change mode to "off-line").
6. Select "Quit" to exit to the previous menu.

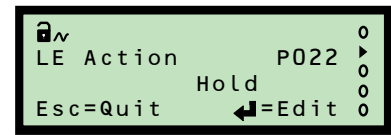

(Rosemount 3491 Screen Shown)

F.3.29 Speed of sound (P024)

Fast Keys	2, 2, 5 [or 6], 4
------------------	-------------------

This is for entering the speed of sound of the gas above the liquid surface (ullage gas) in a closed tank at 32 °F (0 °C) (see Table F-2).

A new speed of sound is then calculated for the ullage gas at the temperature and humidity level in the tank (see calculated Speed of Sound on page 204). The correction for temperature effects is made using the parameter Temperature (page 176) and assumes the entered Speed of Sound (P024) value is valid at 32 °F (0 °C).

For systems monitoring aqueous liquids with air (or nitrogen) as the primary gas in the ullage space, the entered Speed of Sound (P024) value should be 1088.6 ft/s (331.80 m/s). This is the most accurate setting for temperatures in the range of 32 to 104 °F (0 to 40 °C).

If the tank vapor space is filled with a different gas, a revised Speed of Sound (P024) value should be entered. Gas mixtures have speed of sound values calculated as an average according to the proportion of the gases present.

Table F-2. Speed of Sound for Ullage Gases at 32 °F (0 °C)

Ullage Gas	Speed of Sound ft/s (m/s)	Ullage Gas	Speed of Sound ft/s (m/s)
Acetaldehyde	800.53 (244)	Ethylether	675.85 (206)
Ammonia	1361.55 (415)	Methane	1410.76 (430)
Argon	1010.50 (308)	Methanol	1099.08 (335)
Benzene	580.71 (177)	Nitrogen	1105.64 (337)
Carbon Tetrachloride	475.72 (145)	Nitric oxide	1095.80 (334)
Cyclohexane	593.83 (181)	Oxygen	1089.24 (332)
Ethane	1036.35 (316)	Propane	780.84 (238)
Ethylalcohol	846.46 (258)	Sulphur hexafluoride	436.35 (133)

Field Communicator or AMS Device Manager

To view or change the speed of sound setting

- From the *Home* screen, select 2: Configure.
- Select 2: Manual Setup.
- Select 5: Engineering (3105) or 6: Engineering (3102).
- Select 4: Speed of Sound P024.
- If a change is required:
 - Input a new value, and then select “ENTER” to save it.
 - Select “Send” or “Apply” to update the transmitter.

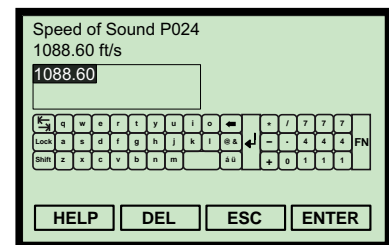

(Field Communicator Screen Shown)

Rosemount 3490 Series Control Unit

To view or change the speed of sound setting

1. From the *Main Menu* screen, select SETUP.
2. Select the transmitter (e.g. "Tx1: 3102").
3. Select ENGINEERING, and then select Speed of Sound.
4. Follow the on-screen instructions to edit and save the new setting.
(Use the Enter (↵) key if prompted to change the mode to "off-line").
5. Select "Quit" to exit to the previous menu.

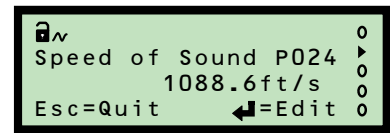

(Rosemount 3491 Screen Shown)

F.3.30 Temperature (P025)

Fast Keys	2, 2, 8 [or 9], 1, 5
------------------	----------------------

This is for temperature-correcting the speed of sound base value in parameter Speed of Sound (page 174).

For automatic (dynamic) corrections using the internal or optional remote temperature sensor, select the “Auto” option. The live temperature measurement is indicated in the read-only parameter Temperature SoS Calculation (page 204). If the sensor fails and “Auto” is selected, the setting reverts to 68 °F (20 °C).

Note

The internal temperature sensor measures the air temperature at the transmitter, and not the average temperature across the ullage space. If the average temperature is known, enter this into Temperature (P025). The same value is then indicated by the read-only parameter Temperature For SoS Calculation (page 204) and is used to correct the speed of sound.

Field Communicator or AMS Device Manager

To view or change the temperature setting

1. From the *Home* screen, select 2: Configure.
2. Select 2: Manual Setup.
3. Select 8: Set Temperature (3105) or 9: Set Temperature (3102).
4. Select 1: Temperature.
5. Select 4: Set Temperature.
6. Select 1: Set to Automatic (NaN) for automatic (dynamic) corrections.
7. Alternatively, select 2: Edit to fix temperature, input a temperature, and then save it by selecting “ENTER”.

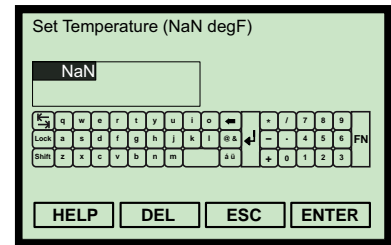

(Field Communicator Screen Shown)

Note

When messages appear, take appropriate action if needed and select “OK”.

Note

Fast Key sequence 2, 2, 8, 1 indicates if the *internal* or *remote temperature sensor* is in use (OFF/ON), and if the temperature is fixed (OFF/ON).

Rosemount 3490 Series Control Unit

To view or change the temperature setting:

1. From the *Main Menu* screen, select SETUP.
2. Select the transmitter (e.g. “Tx1: 3102”).
3. Select ENGINEERING., and then select Temperature.
4. Follow the on-screen instructions to edit and save the new setting. (Use the Enter (↵) key if prompted to change mode to “off-line”).
5. Select “Quit” to exit to the previous menu.

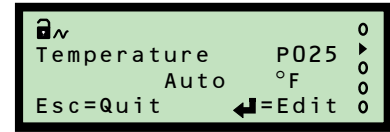

(Rosemount 3491 Screen Shown)

F.3.31 Set threshold (P026)

Fast Keys	2, 2, 7 [or 8], 2, 2
------------------	----------------------

This sets the sensitivity of the echo detection circuits in the transmitter. The threshold is a percentage defining the minimum signal level, above which an echo is detected and treated as a potentially valid surface or target.

When the threshold is set to “Auto”, the sensitivity is automatically adjusted over a range of values, depending on the echo strengths being received. The threshold is adjusted to one quarter of the peak value of the largest signal detected to give best overall performance. The live value is indicated in the read-only Threshold In Use parameter (page 206).

The threshold can be a constant value, which may be needed to overcome on-site difficulties or special conditions.

Note

The threshold value can be adjusted in conjunction with the Upper Blanking (page 138), Lower Blanking (page 140), Threshold 1 Time (page 181), and Threshold 1 Size (page 182).

Field Communicator or AMS Device Manager

To view or change the threshold setting

1. From the *Home* screen, select 2: Configure.
2. Select 2: Manual Setup.
3. Select 7: Advanced Processing (3105) or Select 8: Advanced Processing (3102).
4. Select 2: Threshold, and then select 2: Set Threshold.
5. Select 1: Set to Automatic (NaN) for automatic (dynamic) adjustments.
6. Alternatively, select 2: Edit to fix threshold, input a threshold percentage, and then save it by selecting “ENTER”.

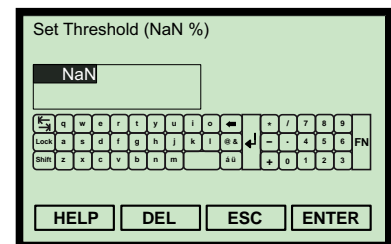

(Field Communicator Screen Shown)

Note

- When messages appear, take appropriate action if needed and select “OK”.

Note

- Fast Key sequence 2, 2, 7, [or 8], 2 indicates the status *Threshold Is Fixed (OFF/ON)* and the status *Threshold Is Not Optimum (OFF/ON)*.

Rosemount 3490 Series Control Unit

To view or change the threshold setting

1. From the *Main Menu* screen, select SETUP.
2. Select the transmitter (e.g. “Tx1: 3102”).
3. Select ENGINEERING, and then select Set Threshold.
4. Follow the on-screen instructions to edit and save the new setting. (Use the Enter (↵) key if prompted to change mode to “off-line”).
5. Select “Quit” to exit to the previous menu.

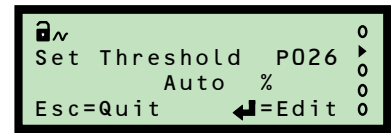

(Rosemount 3491 Screen Shown)

F.3.32 Transmit power control (P040)

Fast Keys	2, 2, 7 [or 8], 4, 1
------------------	----------------------

The transmitted ultrasonic energy can be controlled automatically to avoid strong close echoes saturating the electronics of the transmitter. The live level is indicated in the read-only Transmit Power parameter (page 208).

Field Communicator or AMS Device Manager

To enable or disable the transmit power control

1. From the *Home* screen, select 2: Configure.
2. Select 2: Manual Setup., and then
3. Select 7: Advanced Processing (3105) or Select 8: Advanced Processing (3102)
4. Select 4: Set Power Control, and then select 1: Power Control P040.
5. If a change is required:
 - (a) Select “Disable” or “Enable”, and then select “ENTER” to confirm it.
 - (b) Select “Send” or “Apply” to update the transmitter.

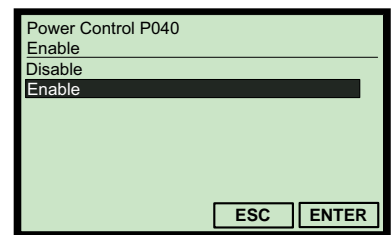

(Field Communicator Screen Shown)

Note

- Fast Key sequence 2, 2, 7 [or 8], 4 indicates the status *Power Control Is Active (OFF/ON)* and the live Transmit Power level

Rosemount 3490 Series Control Unit

To enable or disable the transmit power control

- From the *Main Menu* screen, select SETUP.
- Select the transmitter (e.g. “Tx1: 3102”).
- Select ENGINEERING, and then select ADVANCED.
- Select Tx Pwr Control.
- Follow the on-screen instructions to edit and save the new setting. (Use the Enter (↵) key if prompted to change mode to “off-line”).
- Select “Quit” to exit to the previous menu.

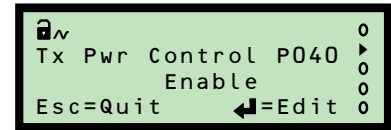

(Rosemount 3491 Screen Shown)

F.3.33 Pulse repeat (P041)

Fast Keys	-
-----------	---

The nominal rate of repetition for ultrasonic pulses from the transmitter is one pulse per second. If two transmitters were located within the same tank, it is possible this would allow ultrasonic pulses from one unit to be received by the other. This can be prevented by having both transmitters operate with different rates of pulse repetition, which means this interference is rejected as not consistent (pulse-to-pulse). Pulse Repeat allows the pulse repetition interval to be adjusted by increments of 0.1 seconds.

This parameter is not available in the 3100 Series DD (Device Descriptor) file. However, it can be adjusted using the integral buttons (see "Setting the pulse repetition frequency (on the 3102/3105)" on page 67).

Rosemount 3490 Series Control Unit

To view or change the pulse rate

- From the *Main Menu* screen, select SETUP.
- Select the transmitter (e.g. “Tx1: 3102”).
- Select ENGINEERING, and then select ADVANCED.
- Select Pulse Repeat.
- Follow the on-screen instructions to edit and save the new setting. (Use the Enter (↵) key if prompted to change mode to “off-line”).
- Select “Quit” to exit to the previous menu.

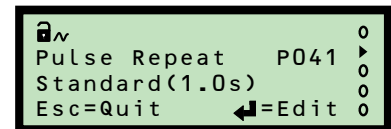

(Rosemount 3491 Screen Shown)

F.3.34 Echoes needed (P042)

Fast Keys	-
-----------	---

Echoes Needed is used to avoid stirrers that give occasional high level signals when they protrude from the liquid surface. The transmitter monitors the echoes returned from the liquid surface or any other target within range.

A valid surface echo is one that exceeds the signal strength threshold consecutively for more ultrasonic pulse cycles than set by Echoes Needed.

This parameter is not available in the 3100 Series DD (Device Descriptor) file. However, it can be adjusted using the integral buttons (see "Setting valid echo count (on the 3102/3105)" on page 68).

Rosemount 3490 Series Control Unit

To view or change the number of echoes needed

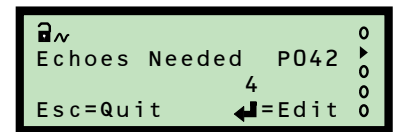

(Rosemount 3491 Screen Shown)

1. From the *Main Menu* screen, select SETUP.
2. Select the transmitter (e.g. "Tx1: 3102").
3. Select ENGINEERING, and then select ADVANCED.
4. Select Echoes Needed.
5. Follow the on-screen instructions to edit and save the new setting. (Use the Enter (↵) key if prompted to change mode to "off-line").
6. Select "Quit" to exit to the previous menu.

F.3.35 Threshold 1 time (P043)

Fast Keys	2, 2, 7 [or 8], 2, 6
------------------	----------------------

False echoes may occur close to the transmitter face. If they occur outside the Upper Blanking distance (page 174), the false echo can be ignored by entering the *echo size* as a percentage and a *time* (representing distance).

Enter the *time* (representing distance) into Threshold 1 Time (P043) e.g. 6 ms represents an approximate distance of 1 m, and 2 ms represents a distance of approximately 1 ft.

See "Threshold 1 size (P048)" on page 182 for entering the *echo size*.

Note

See also "False echoes under certain ambient operating conditions (on the 3102/3105)" on page 75 for additional information about adjusting the settings of parameters P043 and P048.

Field Communicator or AMS Device Manager

To view or change the threshold time

1. From the *Home* screen, select 2: Configure.
2. Select 2: Manual Setup.
3. Select 7: Advanced Processing (3105) or Select 8: Advanced Processing (3102)
4. Select 2: Threshold, and then select 6: Threshold 1 Time P043.
5. If a change is required:
 - (a) Input a new value, and then select "ENTER" to save it.
 - (b) Select "Send" or "Apply" to update the transmitter.

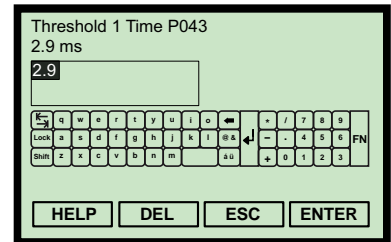

(Field Communicator Screen Shown)

Rosemount 3490 Series Control Unit

To view or change the threshold time

1. From the *Main Menu* screen, select SETUP.
2. Select the transmitter (e.g. "Tx1: 3102").
3. Select ENGINEERING, and then select ADVANCED.
4. Select Thresh 1 Time.
5. Follow the on-screen instructions to edit and save a new setting.
6. Select "Quit" to exit to the previous menu.

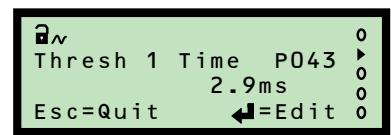

(Rosemount 3491 Screen Shown)

F.3.36 Threshold 1 size (P048)

Fast Keys	2, 2, 7 [or 8], 2, 7
------------------	----------------------

False echoes may occur close to the transmitter face. If they occur outside the Upper Blanking distance (page 174), the false echo can be ignored by entering the *echo size* as a percentage and a *time* (representing distance). The *echo size* is set by the parameter Threshold 1 Size (P048).

See "Threshold 1 time (P043)" on page 181 for entering the *time* (representing distance).

Note

Use the read-only parameter Echo Size (page 200) as a reference for the false echo size.

See also "False echoes under certain ambient operating conditions (on the 3102/3105)" on page 75 for additional information about adjusting the settings of parameters P043 and P048.

Field Communicator or AMS Device Manager

To view or change the threshold size

- From the *Home* screen, select 2: Configure.
- Select 2: Manual Setup.
- Select 7: Advanced Processing (3105) or Select 8: Advanced Processing (3102)
- Select 2: Threshold.
- Select 7: Threshold 1 Size P048.
- If a change is required:
 - Input a new value, and then select "ENTER" to save it.
 - Select "Send" or "Apply" to update the transmitter.

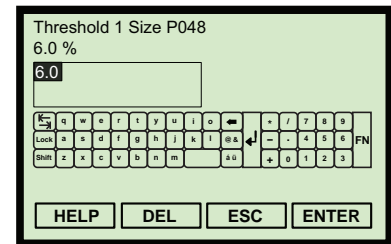

(Field Communicator Screen Shown)

Rosemount 3490 Series Control Unit

To view or change the threshold size

- From the *Main Menu* screen, select SETUP.
- Select the transmitter (e.g. "Tx1: 3102").
- Select ENGINEERING.
- Select ADVANCED.
- Select Thresh 1 Size.
- Follow the on-screen instructions to edit and save the new setting. (Use the Enter (↵) key if prompted to change the mode to "off-line").
- Select "Quit" to exit to the previous menu.

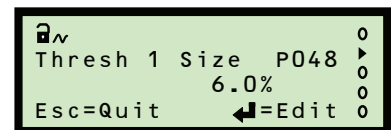

(Rosemount 3491 Screen Shown)

F.3.37 Target pulses (P044)

Fast Keys	2, 2, 7 [or 8], 5, 1
------------------	----------------------

Target Pulses (P044) is the number of ultrasonic pulses in each burst sent from the transmitter every second.

The factory default “Automatic” setting allows the transmitter to decide the number of pulses. Alternatively, select a number in the range 4 to 32.

Note

See Pulses in Use (page 207) for the actual number of pulses used.

Field Communicator or AMS Device Manager

To view or change the number of pulses in a burst

1. From the *Home* screen, select 2: Configure.
2. Select 2: Manual Setup.
3. Select 7: Advanced Processing (3105) or Select 8: Advanced Processing (3102)
4. Select 5: Set Target Pulses.
5. Select 1: Target Pulses P044.
6. If a change is required:
 - (a) Select a new setting, and then select “ENTER” to save it.
 - (b) Select “Send” or “Apply” to update the transmitter.

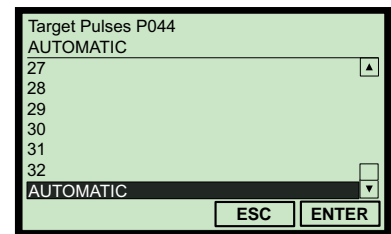

(Field Communicator Screen Shown)

Rosemount 3490 Series Control Unit

To view or change the number of pulses in a burst

1. From the *Main Menu* screen, select SETUP.
2. Select the transmitter (e.g. “Tx1: 3102”).
3. Select ENGINEERING, and then select ADVANCED.
4. Select Target Pulses.
5. Follow the on-screen instructions to edit and save the new setting. (Use the Enter (↵) key if prompted to change mode to “off-line”).
6. Select “Quit” to exit to the previous menu.

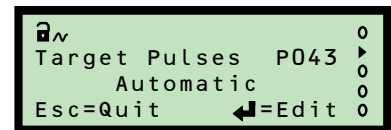

(Rosemount 3491 Screen Shown)

F.3.38 Target frequency (P045)

Fast Keys	2, 2, 7 [or 8], 6, 1
------------------	----------------------

This sets the frequency used for transmitting an ultrasonic pulse. The optimum frequency depends on the characteristics of the transmitter's piezoelectric crystals, which are affected by temperature.

The transmitter has a look-up table to select a frequency value to give the highest echo strength from the prevailing conditions at the site. This look-up function operates when Target Frequency (P045) is set to "Auto".

Site conditions sometimes require a fixed frequency. Target Frequency (P045) is used to set a fixed frequency, but the actual frequency value used is selected from the look-up table and the nearest to that entered value is selected automatically.

Note

See Frequency (page 205) for the actual frequency used.

Field Communicator or AMS Device Manager

To view or change the target frequency

1. From the *Home* screen, select 2: Configure.
2. Select 2: Manual Setup.
3. Select 7: Advanced Processing (3105) or
Select 8: Advanced Processing (3102)
4. Select 6: Set Frequency.
5. Select 1: Target Frequency P045.
6. If a change is required:
 - (a) Select a new setting, and then select "ENTER" to save it.
 - (b) Select "Send" or "Apply" to update the transmitter.

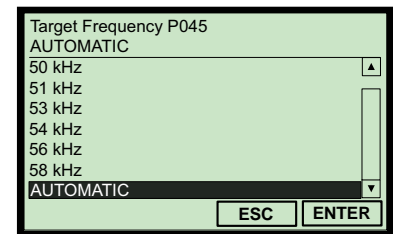

(Field Communicator Screen Shown)

Rosemount 3490 Series Control Unit

To view or change the target frequency

1. From the *Main Menu* screen, select SETUP.
2. Select the transmitter (e.g. “Tx1: 3102”).
3. Select ENGINEERING, and then select ADVANCED.
4. Select Target Freq.
5. Follow the on-screen instructions to edit and save the new setting. (Use the Enter (↵) key if prompted to change mode to “off-line”).
6. Select “Quit” to exit to the previous menu.

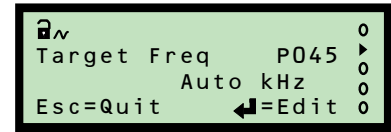

(Rosemount 3491 Screen Shown)

F.3.39 Spike rejection (P049)

Fast Keys	2, 2, 7 [or 8], 3, 1
------------------	----------------------

This sets the minimum duration of a valid echo signal, and is used to reject transient electrical interference (spike) signals.

Note

Spike rejection is switched-off when it is set to 0.

Field Communicator or AMS Device Manager

To view or change the spike rejection

1. From the *Home* screen, select 2: Configure.
2. Select 2: Manual Setup.
3. Select 7: Advanced Processing (3105) or Select 8: Advanced Processing (3102)
4. Select 3: Set Spike Reject.
5. Select 1: Spike Reject P049.
6. If a change is required:
 - (a) Select a new setting, and then select “ENTER” to save it.
 - (b) Select “Send” or “Apply” to update the transmitter.

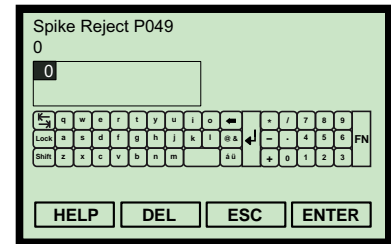

(Field Communicator Screen Shown)

Rosemount 3490 Series Control Unit

To view or change the spike rejection

1. From the *Main Menu* screen, select SETUP.
2. Select the transmitter (e.g. “Tx1: 3102”).
3. Select ENGINEERING.
4. Select ADVANCED.
5. Select Spike Reject.
6. Follow the on-screen instructions to edit and save the new setting. (Use the Enter (↵) key if prompted to change mode to “off-line”).
7. Select “Quit” to exit to the previous menu.

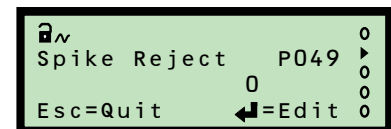

(Rosemount 3491 Screen Shown)

F.3.40 False echo data (P081 to P088)

Fast Keys	2, 2, 6 [or 7], 8
------------------	-------------------

These parameters are the four false echo data records, each storing a false echo as distance-to-surface (e.g. 1.7 m) and echo size (e.g. 44%). The transmitter ignores these false target echoes. See also:

- Section "Learn false echo" on page 122.
- Section "Auto tank map" on page 124.

Field Communicator or AMS Device Manager

To view or change the false echo data

1. From the *Home* screen, select 2: Configure.
2. Select 2: Manual Setup.
3. Select 6: False Echoes (3105) or 7: False Echoes (3102).
4. Select 8: False Echo Data.
5. Select 1 to 8 for the distance-to-surface or echo size data of a false echo record, as appropriate.
6. If a change is required:
 - (a) Select a new setting, and then select "ENTER" to save it.
 - (b) Select "Send" or "Apply" to update the transmitter.

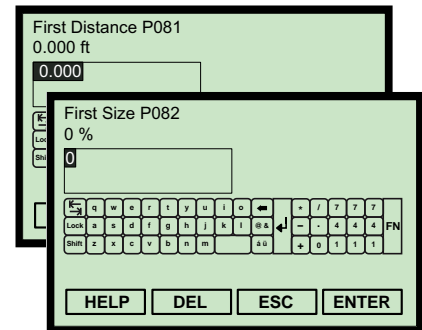

(Field Communicator Screens Shown)

Rosemount 3490 Series Control Unit

To view or change the false echo data

1. From the *Main Menu* screen, select SETUP.
2. Select the transmitter (e.g. "Tx1: 3102").
3. Select ENGINEERING.
4. Select FALSE ECHO DATA.
5. Select a menu option for the distance-to-surface or echo size data of a false echo record, as appropriate.
6. Follow the on-screen instructions to edit and save the new setting. (Use the Enter (↵) key if prompted to change mode to "off-line").
7. Select "Quit" to exit to the previous menu.

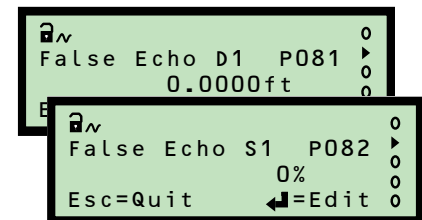

(Rosemount 3491 Screens Shown)

F.3.41 Clear false echoes (P089)

Fast Keys	2, 2, 6 [or 7], 5
------------------	-------------------

This is used to clear a specified False Echo Data record, or clear all of the False Echo Data records.

Field Communicator or AMS Device Manager

To clear false echo data

1. From the *Home* screen, select 2: Configure.
2. Select 2: Manual Setup.
3. Select 6: False Echoes (3105) or 7: False Echoes (3102).
4. Select 5: Clear False Echoes.
5. Select “All” or a numbered false echo record, and then select “ENTER” to confirm the selection.
6. Select “Send” or “Apply” to update the transmitter.

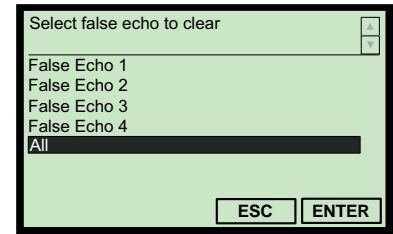

(Field Communicator Screen Shown)

Note

When messages appear, take appropriate action if needed and select “OK”.

Rosemount 3490 Series Control Unit

To clear false echo data

1. From the *Main Menu* screen, select SETUP.
2. Select the transmitter (e.g. “Tx1: 3102”).
3. Select ENGINEERING, and then select FALSE ECHO ACTION.
4. Select Clear False Echoes.
5. Select “Edit” (←), then select an option using the up-arrow or down-arrow keys, and finally select “save” (←) to confirm the selection. (Use the Enter (↵) key if prompted to change mode to “off-line”).
6. When finished, select “Quit” to exit to the previous menu.

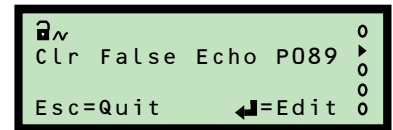

(Rosemount 3491 Screen Shown)

F.3.42 Transducer material (P970)

Fast Keys	1, 3, 1, 2, 1
------------------	---------------

This read-only parameter indicates the construction material used for the transmitter's wet-side.

Field Communicator or AMS Device Manager

To view the transmitter material description

1. From the *Home* screen, select 1: Overview.
2. Select 3: Shortcuts.
3. Select 1: Device Information.
4. Select 2: Materials of Construction.
5. Select 1: Transducer Material P970.
6. When finished, select EXIT to exit to the previous menu.

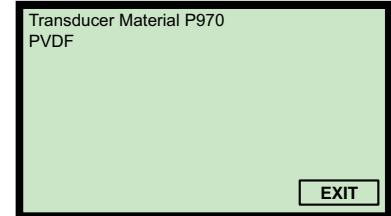

(Field Communicator Screen Shown)

Rosemount 3490 Series Control Unit

To view the transmitter material description

1. From the *Main Menu* screen, select SETUP.
2. Select the transmitter (e.g. "Tx1: 3102").
3. Select SYSTEM.
4. Select FIXED.
5. Select Tx Material.
6. When finished, select EXIT to exit to the previous menu.



(Rosemount 3491 Screen Shown)

F.3.43 Poll address (D951)

Fast Keys	2, 2, 4 [or 5], 2, 1
------------------	----------------------

This indicates the transmitter polling address for the HART protocol.

The poll address range is 0 to 15. When it is 0, the transmitter is in 4–20 mA mode. For all other addresses, the transmitter is in multi-drop mode and the current output is fixed to 4 mA.

Field Communicator or AMS Device Manager

To view or change the poll address

1. From the *Home* screen, select 2: Configure.
2. Select 2: Manual Setup.
3. Select 4: HART/Identity (3105) or 5: HART/Identity (3102).
4. Select 2: Communication, and then select 1: Poll Address D951.
5. If a change is required:
 - (a) Select a new setting, and then select “ENTER” to save it.
 - (b) Select “Send” or “Apply” to update the transmitter.

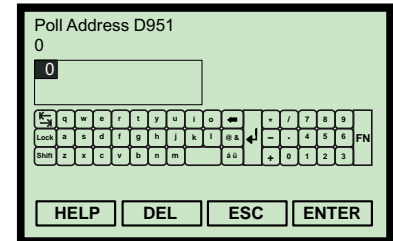

(Field Communicator Screen Shown)

Rosemount 3490 Series Control Unit

To view or change the poll address

1. From the *Main Menu* screen, select SETUP.
2. Select the transmitter (e.g. “Tx1: 3102”).
3. Select SYSTEM.
4. Select FIXED.
5. Select HART.
6. Select Poll Address.
7. Follow the on-screen instructions to edit and save the new setting. (Use the Enter (↵) key if prompted to change mode to “off-line”).
8. When finished, select “Quit” to exit to the previous menu.

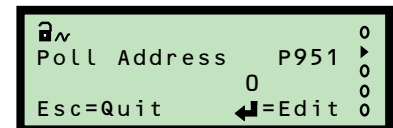

(Rosemount 3491 Screen Shown)

F.3.44 Maximum temperature (P046)

Fast Keys	2, 2, 8 [or 9], 3, 2
------------------	----------------------

This is a record of the maximum measured temperature inside the transmitter.

Field Communicator or AMS Device Manager

To view the maximum temperature

1. From the *Home* screen, select 2: Configure.
2. Select 2: Manual Setup.
3. Select 8: Set Temperature (3105) or 9: Set Temperature (3102).
4. Select 3: Internal Extremes.
5. Select 2: Maximum Temperature P046.

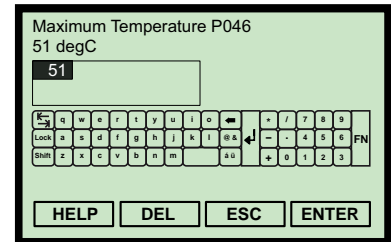

(Field Communicator Screen Shown)

Rosemount 3490 Series Control Unit

To view the maximum temperature

1. From the *Main Menu* screen, select MONITOR.
2. Select the transmitter (e.g. "Tx1: 3102").
3. Select DIAGNOSTICS.
4. Select HISTORY.
5. Select Max Temp.
6. When finished, select EXIT to exit to the previous menu.

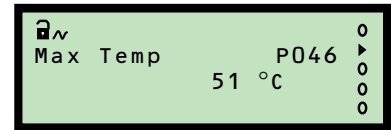

(Rosemount 3491 Screen Shown)

F.3.45 Minimum temperature (P047)

Fast Keys	2, 2, 8 [or 9], 3, 4
------------------	----------------------

This is a record of the lowest measured temperature inside the transmitter.

Field Communicator or AMS Device Manager

To view the minimum temperature

1. From the *Home* screen, select 2: Configure.
2. Select 2: Manual Setup.
3. Select 8: Set Temperature (3105) or 9: Set Temperature (3102).
4. Select 3: Internal Extremes.
5. Select 4: Minimum Temperature P047.

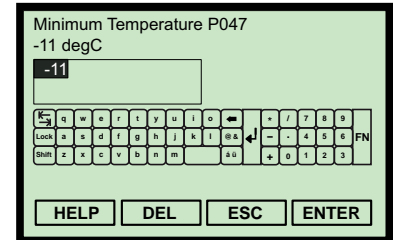

(Field Communicator Screen Shown)

Rosemount 3490 Series Control Unit

To view the minimum temperature

1. From the *Main Menu* screen, select MONITOR.
2. Select the transmitter (e.g. "Tx1: 3102").
3. Select DIAGNOSTICS.
4. Select HISTORY.
5. Select Min Temp.
6. When finished, select EXIT to exit to the previous menu.

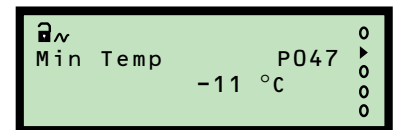

(Rosemount 3491 Screen Shown)

F.3.46 Date (P003)

Fast Keys	2, 2, 4 [or 5], 1, 6
-----------	----------------------

Field Communicator or AMS Device Manager

To view the date

1. From the *Home* screen, select 2: Configure.
2. Select 2: Manual Setup.
3. Select 4: HART/Identity (3105) or 5: HART/Identity (3102).
4. Select 1: Identity.
5. Select 6: Date P003.

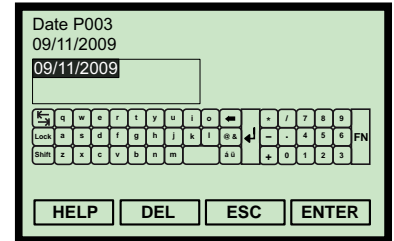

(Field Communicator Screen Shown)

Rosemount 3490 Series Control Unit

To view the date

1. From the *Main Menu* screen, select MONITOR.
2. Select the transmitter (e.g. "Tx1: 3102").
3. Select DIAGNOSTICS.
4. Select HISTORY.
5. Select Date.
6. When finished, select EXIT to exit to the previous menu.

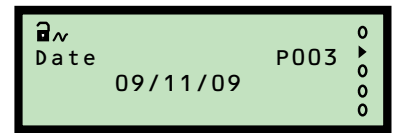

(Rosemount 3491 Screen Shown)

F.4 Monitoring and diagnostic parameters

Note

- For relevant menu structures, refer to [Appendix D: Rosemount 3490 Series Menus](#) or [Appendix E: Field Communicator Menus](#) as appropriate for your HART Master Device

F.4.1 Process value / primary variable (PV) (D900)

Fast Keys	1, 2, 1
-----------	---------

This indicates the live process value that drives the 4–20 mA Current Output. In HART terminology, this parameter is the Primary Variable (PV).

The factory default is for the process value to be a level measurement in meters, feet, or inches. It can be a volume or flow measurement if the transmitter has been configured to do those calculations.

Note

Reported units for the HART Primary Variable is selectable (see [page 153](#)).

Field Communicator or AMS Device Manager

To view the live PV

- From the *Home* screen, select 1: Overview.
- Select 2: Primary Purpose Variables.
- Select 1: Primary Variable D900.
- When finished, select EXIT to exit to the previous menu.

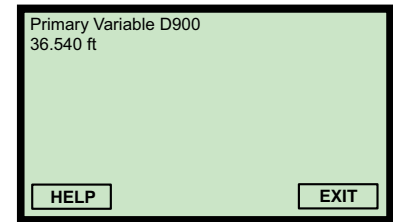

(Field Communicator Screen Shown)

Note

PV is available at other Fast Key sequences e.g. 3, 2, 1, 1 (see [Appendix E: Field Communicator Menus](#)).

Rosemount 3490 Series Control Unit

To view the live PV:

- From the *Main Menu* screen, select MONITOR.
- Select the transmitter (e.g. "Tx1: 3102").
- Select READINGS.
- Select VARIABLES.
- Select Xmtr PV.
- When finished, select "Quit" to exit to the previous menu.

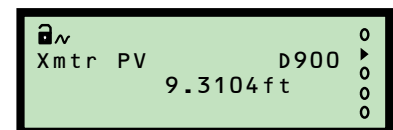

(Rosemount 3491 Screen Shown)

F.4.2 Level / Secondary Variable (SV) (D901)

Fast Keys	1, 2, 2
-----------	---------

This indicates the live level measured by the transmitter. In HART terminology, SV is the Secondary Variable. Units are in meters, feet, or inches depending on base units (see [page 118](#))

Note

Figure F-1 on [page 137](#) shows this parameter in a tank geometry illustration.

Field Communicator or AMS Device Manager

To view the live level measurement

1. From the *Home* screen, select 1: Overview.
2. Select 2: Primary Purpose Variables.
3. Select 2: Level (SV) D901.
4. When finished, select EXIT to exit to the previous menu.

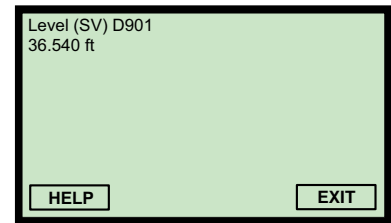

(Field Communicator Screen Shown)

Note

SV is also at the Fast Key sequence 3, 2, 1, 2 (see [Appendix E: Field Communicator Menus](#)).

Rosemount 3490 Series Control Unit

To view the live level measurement

1. From the *Main Menu* screen, select MONITOR.
2. Select the transmitter (e.g. "Tx1: 3102").
3. Select READINGS, and then select VARIABLES.
4. Select Level (SV).
5. When finished, use the ESC key to exit to the previous menu.

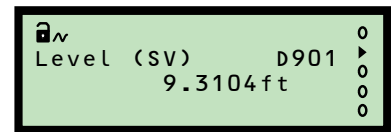

(Rosemount 3491 Screen Shown)

F.4.3 Distance / tertiary variable (TV) (D902)

Fast Keys	3, 2, 1, 3
------------------	------------

This indicates the live distance-to-surface measured by the transmitter relative to the user-preferred sensor reference point (UPSRP).

In HART terminology, this parameter is the Tertiary Variable (TV). Units are in meters, feet, or inches, depending on base units (see [page 118](#)).

Note

Figure F-1 on [page 137](#) shows this parameter in a tank geometry illustration.

Field Communicator or AMS Device Manager

To view the live distance-to-surface measurement

1. From the *Home* screen, select 3: Service Tools.
2. Select 2: Variables, and then select 1: Variables.
3. Select 3: Distance (TV) D902.
4. When finished, select EXIT to exit to the previous menu.

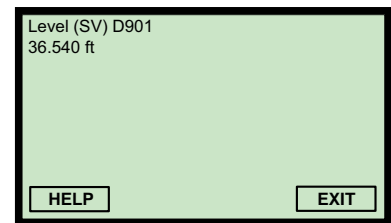

(Field Communicator Screen Shown)

Rosemount 3490 Series Control Unit

To view the live distance-to-surface measurement

1. From the *Main Menu* screen, select MONITOR.
2. Select the transmitter (e.g. "Tx1: 3102").
3. Select READINGS, and then select VARIABLES.
4. Select Distance (TV).
5. When finished, use the ESC key to exit to the previous menu.

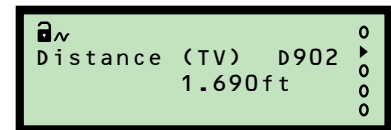

(Rosemount 3491 Screen Shown)

F.4.4 Temperature / fourth variable (FV) (D903)

Fast Keys	3, 2, 1, 4
------------------	------------

This indicates the live ambient temperature measured by the transmitter.

In HART terminology, this parameter is the Fourth Variable (FV). Measurement units are in °C or °F depending on Base Units (page 118)

Field Communicator or AMS Device Manager

To view the live temperature measurement

1. From the *Home* screen, select 3: Service Tools.
2. Select 2: Variables.
3. Select 1: Variables.
4. Select 4: Transducer Temperature D903.
5. When finished, select EXIT to exit to the previous menu.

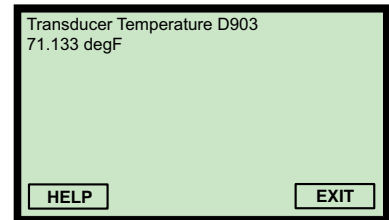

(Field Communicator Screen Shown)

Rosemount 3490 Series Control Unit

To view the live temperature measurement

1. From the *Main Menu* screen, select MONITOR.
2. Select the transmitter (e.g. "Tx1: 3102").
3. Select READINGS.
4. Select VARIABLES.
5. Select Xducer temp.
6. When finished, use the ESC key to exit to the previous menu.

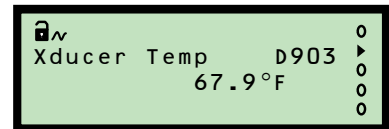

(Rosemount 3491 Screen Shown)

F.4.5 % of current output (D905)

Fast Keys	3, 2, 2, 3
-----------	------------

This indicates the percentage of the 4–20 mA output current in use.

- 0% represents 4 mA
- 100% represents 20 mA

Note

When the Poll Address (page 210) is a non-zero number, the transmitter is in *multi-drop mode* and the current output is fixed at 4 mA. However, the read-only parameter D905 remains active.

Field Communicator or AMS Device Manager

To view the percentage of current output in use

1. From the *Home* screen, select 3: Service Tools.
2. Select 2: Variables.
3. Select 2: Analog Output.
4. Select 3: Percentage of Current Output.
5. When finished, use the Bksp key to exit to the previous menu.

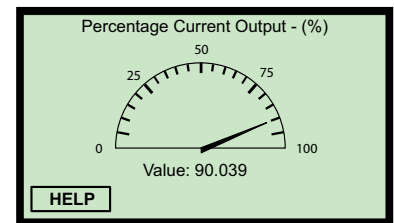

(Field Communicator Screen Shown)

Rosemount 3490 Series Control Unit

To view the percentage of current output in use

1. From the *Main Menu* screen, select MONITOR.
2. Select the transmitter (e.g. “Tx1: 3102”).
3. Select READINGS, and then select CURRENT.
4. Select % of Current Output.
5. When finished, use the ESC key to exit to the previous menu.

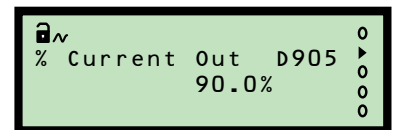

(Rosemount 3491 Screen Shown)

F.4.6 Current output (D906)

Fast Keys	3, 2, 2, 1
-----------	------------

This indicates the actual output current in mA.

Note

When the Poll Address (page 210) is a non-zero number, the transmitter is in *multi-drop mode* and the current output is fixed at 4 mA.

Field Communicator or AMS Device Manager

To view the actual output current

1. From the *Home* screen, select 3: Service Tools.
2. Select 2: Variables.
3. Select 2: Analog Output
4. Select 1: Current Output.
5. When finished, use the Bksp key to exit to the previous menu.

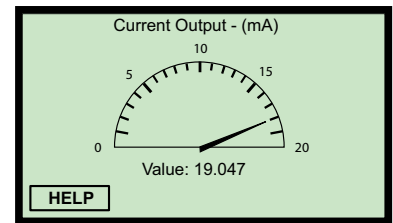

(Field Communicator Screen Shown)

Rosemount 3490 Series Control Unit

To view the actual output current

1. From the *Main Menu* screen, select MONITOR.
2. Select the transmitter (e.g. "Tx1: 3102").
3. Select READINGS, and then select CURRENT.
4. Select Current Output.
5. When finished, use the ESC key to exit to the previous menu.

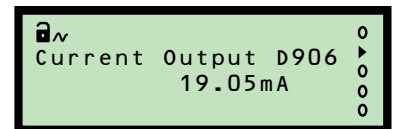

(Rosemount 3491 Screen Shown)

F.4.7 Distance (D910)

Fast Keys	3, 1, 2, 1, 1
-----------	---------------

This indicates the distance from the transmitter face to a detected surface.

It is a useful diagnostic because a false surface signal can be identified and related to the physical nature of the installation.

Note

Figure F-1 on page 137 shows this parameter in a tank geometry illustration.

Field Communicator or AMS Device Manager

To view the distance to a detected surface

1. From the *Home* screen, select 3: Service Tools.
2. Select 1: Alerts.
3. Select 2: Diagnostic Data.
4. Select 1: Target Data.
5. Select 1: Distance D910.
6. When finished, select EXIT to exit to the previous menu.

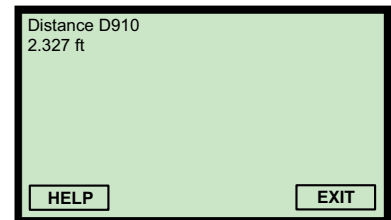

(Field Communicator Screen Shown)

Rosemount 3490 Series Control Unit

To view the distance to a detected surface

1. From the *Main Menu* screen, select MONITOR.
2. Select the transmitter (e.g. "Tx1: 3102").
3. Select DIAGNOSTICS, and then select Distance.
4. When finished, use the ESC key to exit to the previous menu.

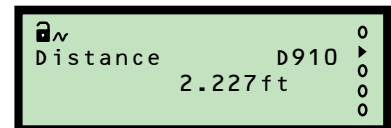

(Rosemount 3491 Screen Shown)

F.4.8 Echo size (D911)

Fast Keys	3, 1, 2, 1, 2
------------------	---------------

The size of the echo returned from a surface depends on the surface range, gas composition and temperature, transmitter performance, in-tank conditions (turbulence, presence of surface foam, and draughts), and other factors.

The received echo strength may vary from pulse-to-pulse but monitoring the read-only parameter Echo Size (D911) indicates the latest echo strengths.

The indicated value is an averaged percentage of the last five echoes, with 100% representing a saturated returned signal.

Field Communicator or AMS Device Manager

To view the echo strength

1. From the *Home* screen, select 3: Service Tools.
2. Select 1: Alerts.
3. Select 2: Diagnostic Data.
4. Select 1: Target Data.
5. Select 2: Echo Size D911.
6. When finished, select EXIT to exit to the previous menu.

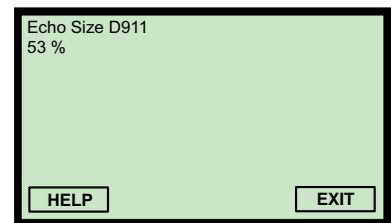

(Field Communicator Screen Shown)

Rosemount 3490 Series Control Unit

To view the echo strength

1. From the *Main Menu* screen, select MONITOR.
2. Select the transmitter (e.g. "Tx1: 3102").
3. Select DIAGNOSTICS
4. Select Echo Size.
5. When finished, use the ESC key to exit to the previous menu.

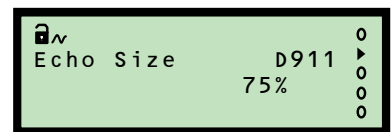

(Rosemount 3491 Screen Shown)

F.4.9 Echo success (D912)

Fast Keys	3, 1, 2, 1, 3
------------------	---------------

This is a measure of the quality of the echo returned. It is a percentage indicating the success rate achieved from the last ten pulse transmissions.

The success rate may fall below 100% due to the effect of extreme surface turbulence or stirrers, which might return a surface echo that is then rejected by the transmitter.

A surface echo might be rejected because it is outside the allowed 'window', set-up to establish the true liquid level. This rejects invalid readings on the principle that liquid levels do not change very quickly (see "Lost Echo Delay" on page 170).

One rejected surface echo causes Echo Success to decrease by 10%, but a subsequent valid surface echo increases the percentage by 10%. The transmitter is biased to ignore sudden liquid level changes.

Field Communicator or AMS Device Manager

To view the echo success

1. From the *Home* screen, select 3: Service Tools.
2. Select 1: Alerts.
3. Select 2: Diagnostic Data.
4. Select 1: Target Data.
5. Select 3: Success Rate D912.
6. When finished, select EXIT to exit to the previous menu.

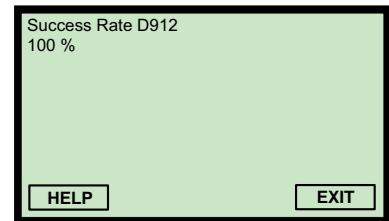

(Field Communicator Screen Shown)

Rosemount 3490 Series Control Unit

To view the echo success

1. From the *Main Menu* screen, select MONITOR.
2. Select the transmitter (e.g. "Tx1: 3102").
3. Select DIAGNOSTICS
4. Select Echo Success.
5. When finished, use the ESC key to exit to the previous menu.



(Rosemount 3491 Screen Shown)

F.4.10 Target echoes (D913)

Fast Keys	3, 1, 2, 1, 4
------------------	---------------

This indicates the number of echoes detected by the transmitter. The maximum number displayed is seven.

The echo closest to the transmitter face, i.e. the highest liquid level, is used to calculate the PV (page 193). This is because the other echoes may be caused by multiple path surface reflections from the tank roof or wall.

Field Communicator or AMS Device Manager

To view the number of echoes received

1. From the *Home* screen, select 3: Service Tools.
2. Select 1: Alerts.
3. Select 2: Diagnostic Data.
4. Select 1: Target Data.
5. Select 4: Target Echoes D913.
6. When finished, select EXIT to exit to the previous menu.

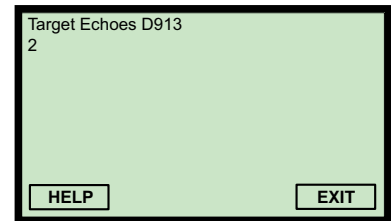

(Field Communicator Screen Shown)

Rosemount 3490 Series Control Unit

To view the number of echoes received

1. From the *Main Menu* screen, select MONITOR.
2. Select the transmitter (e.g. "Tx1: 3102").
3. Select DIAGNOSTICS.
4. Select Target Echoes.
5. When finished, use the ESC key to exit to the previous menu.

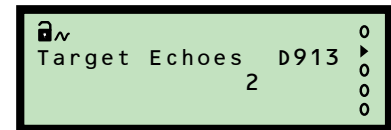

(Rosemount 3491 Screen Shown)

F.4.11 Speed of sound (D914)

Fast Keys	3, 1, 2, 2, 1
------------------	---------------

This indicates the temperature-corrected speed of sound calculated by the transmitter. It relates the returned echo time delay to a distance. The value is calculated using the Temperature SoS Calc value (page 204) and the base value entered into configuration parameter Speed of Sound (page 174).

Field Communicator or AMS Device Manager

To view the calculated speed of sound

1. From the *Home* screen, select 3: Service Tools.
2. Select 1: Alerts.
3. Select 2: Diagnostic Data.
4. Select 2: Speed of Sound Data.
5. Select 1: Speed of Sound D914.
6. When finished, select “EXIT” to return to the previous menu.

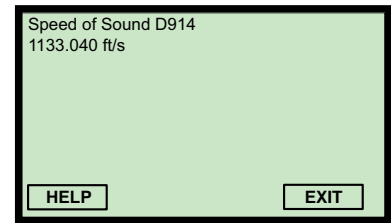

(Field Communicator Screen Shown)

Rosemount 3490 Series Control Unit

To view the calculated speed of sound

1. From the *Main Menu* screen, select MONITOR.
2. Select the transmitter (e.g. “Tx1: 3102”).
3. Select DIAGNOSTICS.
4. Select Speed of Sound.
5. When finished, use the ESC key to exit to the previous menu.

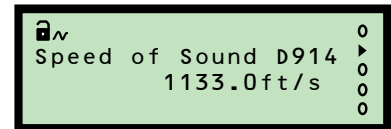

(Rosemount 3491 Screen Shown)

F.4.12 Temperature for SoS calculation (D915)

Fast Keys	3, 1, 2, 2, 2
------------------	---------------

This indicates the temperature used in calculating the temperature-corrected speed of sound (see above). The temperature may be a live or fixed value depending on the configuration of the parameter Temperature (page 176).

Note

The live temperature is always indicated in the read-only parameter Temperature / Fourth Variable (FV) (page 196).

Field Communicator or AMS Device Manager

To view the temperature used for calculating the speed of sound

1. From the *Home* screen, select 3: Service Tools.
2. Select 1: Alerts.
3. Select 2: Diagnostic Data.
4. Select 2: Speed of Sound Data.
5. Select 2: Temperature for Calculation D915.
6. When finished, select EXIT to exit to the previous menu.

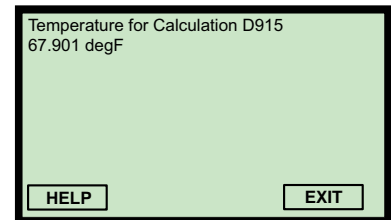

(Field Communicator Screen Shown)

Note

This is also at the Fast Key sequence 2, 2, 8 [or 9], 1, 6 (see Appendix E: Field Communicator Menus for a menu tree diagram).

Rosemount 3490 Series Control Unit

To view the temperature used for calculating the speed of sound

1. From the *Main Menu* screen, select MONITOR.
2. Select the transmitter (e.g. "Tx1: 3102").
3. Select DIAGNOSTICS.
4. Select Temp SoS Calc.
5. When finished, use the ESC key to exit to the previous menu.

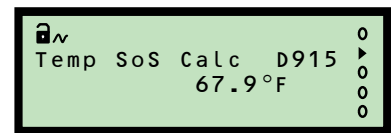

(Rosemount 3491 Screen Shown)

Note

Units are in °C or °F depending on the base units selected (see page 118).

F.4.13 Frequency (D916)

Fast Keys	3, 1, 2, 3, 1
-----------	---------------

This indicates the transmitter's actual operating frequency.

The factory default setting is to automatically set the operating frequency for optimum performance (see Target Frequency on [page 184](#)).

Field Communicator or AMS Device Manager

To view the actual operating frequency

1. From the *Home* screen, select 3: Service Tools.
2. Select 1: Alerts.
3. Select 2: Diagnostic Data.
4. Select 3: Operation, and then select 1: Transducer Frequency D916.
5. When finished, select EXIT to exit to the previous menu.

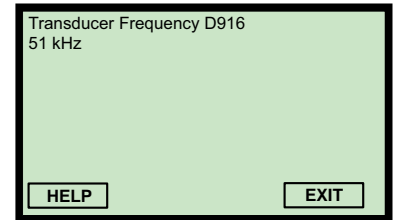

(Field Communicator Screen Shown)

Note

This is also at the Fast Key sequence 2, 2, 7 [or 8], 6, 2 (see [Appendix E: Field Communicator Menus](#) for a menu tree diagram).

Rosemount 3490 Series Control Unit

To view the actual operating frequency

1. From the *Main Menu* screen, select MONITOR.
2. Select the transmitter (e.g. "Tx1: 3102").
3. Select DIAGNOSTICS, and then select OPERATION.
4. Select Xducer Freq.
5. When finished, use the ESC key to exit to the previous menu.

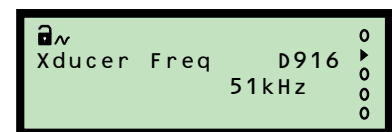

(Rosemount 3491 Screen Shown)

F.4.14 Threshold in use (D917)

Fast Keys	3, 1, 2, 3, 2
------------------	---------------

This indicates the echo strength threshold limit, below which echoes are rejected. The factory default setting is to automatically set the threshold level for optimum performance (see Set Threshold on [page 177](#)).

Field Communicator or AMS Device Manager

To view the threshold limit

1. From the *Home* screen, select 3: Service Tools.
2. Select 1: Alerts.
3. Select 2: Diagnostic Data.
4. Select 3: Operation, and then select 2: Threshold In Use D917.
5. When finished, select EXIT to exit to the previous menu.

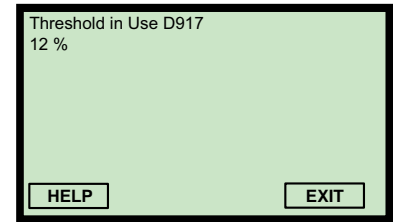

(Field Communicator Screen Shown)

Note

This is also at the Fast Key sequence 2, 2, 7 [or 8], 2, 4 (see [Appendix E: Field Communicator Menus](#) for a menu tree diagram).

Rosemount 3490 Series Control Unit

To view the threshold limit

1. From the *Main Menu* screen, select MONITOR.
2. Select the transmitter (e.g. "Tx1: 3102").
3. Select DIAGNOSTICS, and then select OPERATION.
4. Select Thresh In Use.
5. When finished, use the ESC key to exit to the previous menu.

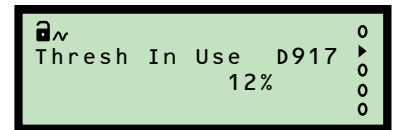

(Rosemount 3491 Screen Shown)

F.4.15 Pulses in use (D918)

Fast Keys	3, 1, 2, 3, 3
-----------	---------------

This is the actual number of pulses transmitted in the previous burst of pulses.

Note

The factory default setting is to automatically decide the number of pulses in a burst for optimum performance (see Target Pulses on [page 183](#)).

Field Communicator or AMS Device Manager

To view the number of pulses being used in a burst

1. From the *Home* screen, select 3: Service Tools.
2. Select 1: Alerts.
3. Select 2: Diagnostic Data.
4. Select 3: Operation.
5. Select 3: Pulses In Use D918.
6. When finished, select EXIT to exit to the previous menu.

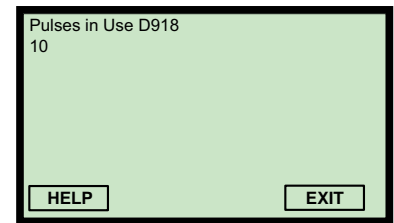

(Field Communicator Screen Shown)

Note

This is also at the Fast Key sequence 2, 2, 7 [or 8], 5, 2 (see [Appendix E: Field Communicator Menus](#) for a menu tree diagram).

Rosemount 3490 Series Control Unit

To view the number of pulses being used in a burst

1. From the *Main Menu* screen, select MONITOR.
2. Select the transmitter (e.g. "Tx1: 3102").
3. Select DIAGNOSTICS.
4. Select OPERATION.
5. Select Pulses In Use.
6. When finished, use the ESC key to exit to the previous menu.

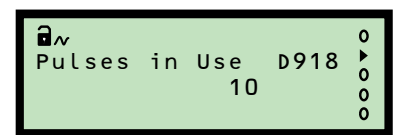

(Rosemount 3491 Screen Shown)

F.4.16 Transmit power (D919)

Fast Keys	3, 1, 2, 3, 4
------------------	---------------

This indicates the level of power in use for ultrasonic pulse transmission.

- The lower the level number, the less power is being used
- The higher the level number, the more power being used

Note

The factory default setting is to optimize the power needed for ultrasonic pulse transmission (see Transmit Power Control on [page 178](#)).

Field Communicator or AMS Device Manager

To view the pulse transmission power in use

1. From the *Home* screen, select 3: Service Tools.
2. Select 1: Alerts.
3. Select 2: Diagnostic Data.
4. Select 3: Operation.
5. Select 4: Transmit Power D919.
6. When finished, select EXIT to exit to the previous menu.

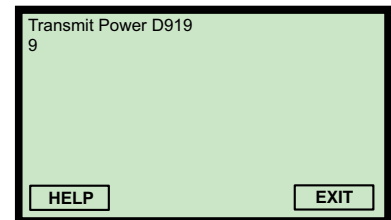

(Field Communicator Screen Shown)

Note

This is also at the Fast Key sequence 2, 2, 7 [or 8], 4, 3 (see [Appendix E: Field Communicator Menus](#) for a menu tree diagram).

Rosemount 3490 Series Control Unit

To view the pulse transmission power in use

1. From the *Main Menu* screen, select MONITOR.
2. Select the transmitter (e.g. "Tx1: 3102").
3. Select DIAGNOSTICS.
4. Select OPERATION.
5. Select Transmit Power.
6. When finished, use the ESC key to exit to the previous menu.

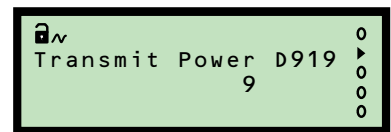

(Rosemount 3491 Screen Shown)

F.4.17 Model code (D949)

Fast Keys	1, 3, 1, 1, 1, 2
-----------	------------------

This indicates the transmitter model code.

Field Communicator or AMS Device Manager

To view the transmitter model code

1. From the *Home* screen, select 1: Overview.
2. Select 3: Shortcuts.
3. Select 1: Device Information *twice*.
4. Select 1: Identification.
5. Select 2: Model Code D949.
6. When finished, select EXIT to exit to the previous menu.

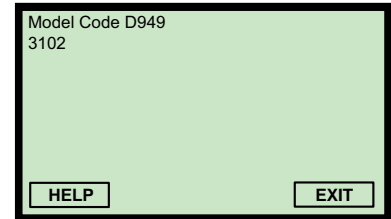

(Field Communicator Screen Shown)

Note

This is also at the Fast Key sequence 2, 2, 4 [or 5], 1, 5 (see [Appendix E: Field Communicator Menus](#) for a menu tree diagram).

Rosemount 3490 Series Control Unit

To view the transmitter model code

1. From the *Main Menu* screen, select SETUP.
2. Select the transmitter (e.g. "Tx1: 3102").
3. Select SYSTEM.
4. Select FIXED.
5. Select HART.
6. Select Model Code.
7. When finished, use the ESC key to exit to the previous menu.

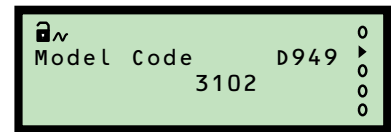

(Rosemount 3491 Screen Shown)

F.4.18 Hardware rev. (D952)

Fast Keys	1, 3, 1, 1, 1, 7
------------------	------------------

This is the overall hardware revision number of at time of manufacture.

Field Communicator or AMS Device Manager

To view the hardware revision number

1. From the *Home* screen, select 1: Overview.
2. Select 3: Shortcuts.
3. Select 1: Device Information (*twice*).
4. Select 1: Identification.
5. Select 7: Hardware Revision D952.
6. When finished, select EXIT to exit to the previous menu.

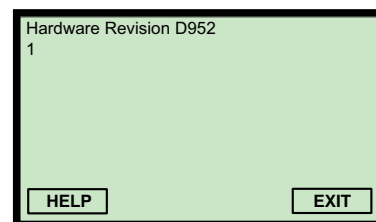

(Field Communicator Screen Shown)

Rosemount 3490 Series Control Unit

To view the hardware revision number

1. From the *Main Menu* screen, select SETUP.
2. Select the transmitter (e.g. "Tx1: 3102").
3. Select SYSTEM.
4. Select FIXED.
5. Select HART.
6. Select Hardware Rev.
7. When finished, use the ESC key to exit to the previous menu.

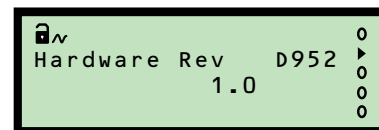

(Rosemount 3491 Screen Shown)

F.4.19 Software revision (D953)

Fast Keys	1, 3, 1, 1, 1, 6
------------------	------------------

This is the embedded software revision number at time of manufacture.

Field Communicator or AMS Device Manager

To view the software revision number

1. From the *Home* screen, select 1: Overview.
2. Select 3: Shortcuts.
3. Select 1: Device Information (*twice*).
4. Select 1: Identification.
5. Select 6: Software Revision D953.
6. When finished, select EXIT to exit to the previous menu.

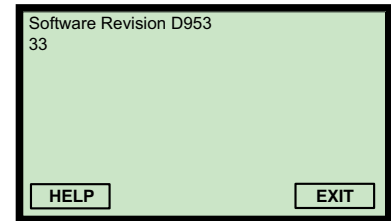

(Field Communicator Screen Shown)

Rosemount 3490 Series Control Unit

To view the software revision number

1. From the *Main Menu* screen, select SETUP.
2. Select the transmitter (e.g. "Tx1: 3102").
3. Select SYSTEM.
4. Select FIXED.
5. Select HART.
6. Select Software Rev.
7. When finished, use the ESC key to exit to the previous menu.

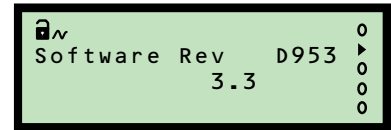

(Rosemount 3491 Screen Shown)

F.4.20 Manufacturer (D960)

Fast Keys	2, 2, 4 [or 5], 1, 4
------------------	----------------------

This is the manufacturer name.

Field Communicator or AMS Device Manager

To view the manufacturer name

1. From the *Home* screen, select 2: Configure.
2. Select 2: Manual Setup.
3. Select 4: HART/Identity (3105) or 5: HART/Identity (3102).
4. Select 1: Identity.
5. Select 4: Manufacturer D960.
6. When finished, select EXIT to exit to the previous menu.

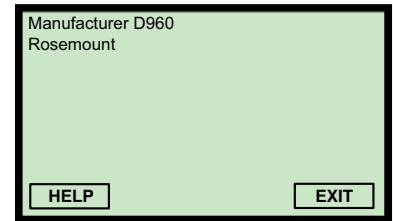

(Field Communicator Screen Shown)

Rosemount 3490 Series Control Unit

To view the manufacturer name

1. From the *Main Menu* screen, select SETUP.
2. Select the transmitter (e.g. "Tx1: 3102").
3. Select SYSTEM.
4. Select FIXED.
5. Select HART.
6. Select Manufacturer.
7. When finished, use the ESC key to exit to the previous menu.

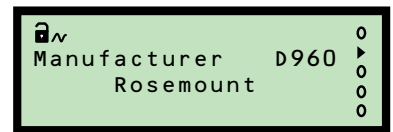

(Rosemount 3491 Screen Shown)

F.4.21 Unique device ID (D961)

Fast Keys	2, 2, 4 [or 5], 1, 7
------------------	----------------------

This is a factory set unique device identification number and is used by the HART protocol. It is typically the same as the Serial Number (page 135).

Field Communicator or AMS Device Manager

To view the factory set unique device identification number

1. From the *Home* screen, select 2: Configure.
2. Select 2: Manual Setup.
3. Select 4: HART/Identity (3105) or 5: HART/Identity (3102).
4. Select 1: Identity.
5. Select 7: Device ID D961.
6. When finished, select EXIT to exit to the previous menu.

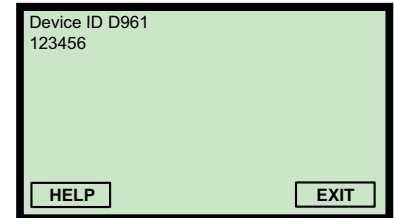

(Field Communicator Screen Shown)

Rosemount 3490 Series Control Unit

To view the factory set unique device identification number

1. From the *Main Menu* screen, select SETUP.
2. Select the transmitter (e.g. "Tx1: 3102").
3. Select SYSTEM.
4. Select FIXED.
5. Select HART.
6. Select Unique ID.
7. When finished, use the ESC key to exit to the previous menu.

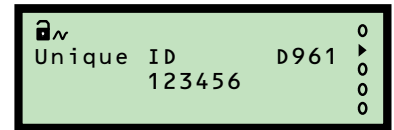

(Rosemount 3491 Screen Shown)

F.4.22 HART revision (D962)

Fast Keys	1, 3, 1, 1, 1, 4
------------------	------------------

This is the major revision number of the standard used for the HART communications protocol.

Field Communicator or AMS Device Manager

To view the HART revision number

1. From the *Home* screen, select 1: Overview.
2. Select 3: Shortcuts.
3. Select 1: Device Information (*twice*).
4. Select 1: Identification.
5. Select 4: HART Revision D962.
6. When finished, select EXIT to exit to the previous menu.

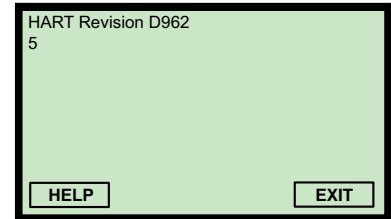

(Field Communicator Screen Shown)

Rosemount 3490 Series Control Unit

To view the HART revision number

1. From the *Main Menu* screen, select SETUP.
2. Select the transmitter (e.g. "Tx1: 3102").
3. Select SYSTEM.
4. Select FIXED.
5. Select HART.
6. Select HART Rev.
7. When finished, use the ESC key to exit to the previous menu.

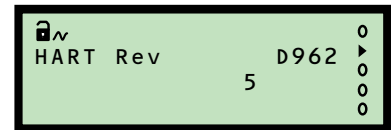

(Rosemount 3491 Screen Shown)

F.4.23 Transmitter specific command revision (D963)

Fast Keys	1, 3, 1, 1, 1, 5
------------------	------------------

This is the minor revision number of specific (non-standard) HART commands supported by the transmitter.

Field Communicator or AMS Device Manager

To view the revision number

1. From the *Home* screen, select 1: Overview.
2. Select 3: Shortcuts.
3. Select 1: Device Information (*twice*).
4. Select 1: Identification.
5. Select 5: Device Revision D963.
6. When finished, select EXIT to exit to the previous menu.

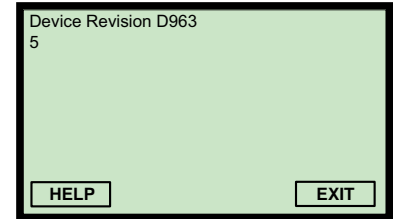

(Field Communicator Screen Shown)

Rosemount 3490 Series Control Unit

To view the revision number

1. From the *Main Menu* screen, select SETUP.
2. Select the transmitter (e.g. "Tx1: 3102").
3. Select SYSTEM.
4. Select FIXED.
5. Select HART.
6. Select Field Dev Rev.
7. When finished, use the ESC key to exit to the previous menu.



(Rosemount 3491 Screen Shown)

F.4.24 Preambles (D964)

Fast Keys	2, 2, 4 [or 5], 2, 2
------------------	----------------------

This is read by a HART Master Device e.g. a Rosemount 3490 Series Control Unit to determine how many preamble bytes are to be sent with each HART protocol message.

Field Communicator or AMS Device Manager

To view the number of preamble bytes

1. From the *Home* screen, select 2: Configure.
2. Select 2: Manual Setup.
3. Select 4: HART/Identity (3105) or 5: HART/Identity (3102).
4. Select 2: Communication.
5. Select 2: Preambles D964.
6. When finished, select EXIT to exit to the previous menu.

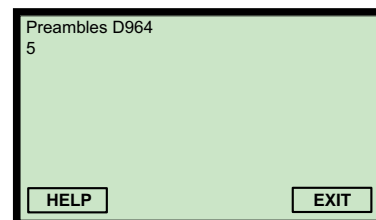

(Field Communicator Screen Shown)

Rosemount 3490 Series Control Unit

To view the number of preamble bytes

1. From the *Main Menu* screen, select SETUP.
2. Select the transmitter (e.g. "Tx1: 3102").
3. Select SYSTEM.
4. Select FIXED.
5. Select HART.
6. Select Num Req Preams.
7. When finished, use the ESC key to exit to the previous menu.

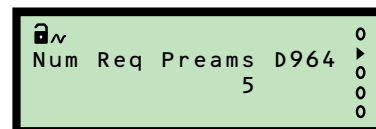

(Rosemount 3491 Screen Shown)

F.4.25 Transmitter flags (D965)

Fast Keys	-
-----------	---

These flags (8 digits) are used by the HART protocol.

Field Communicator or AMS Device Manager

This parameter is not available in the 3100 Series DD (Device Descriptor) file.

Rosemount 3490 Series Control Unit

To view the flags

1. From the *Main Menu* screen, select SETUP.
2. Select the transmitter (e.g. "Tx1: 3102").
3. Select SYSTEM, and then select FIXED.
4. Select HART, and then select Flags.
5. When finished, use the ESC key to exit to the previous menu.

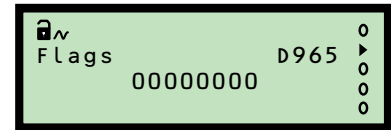

(Rosemount 3491 Screen Shown)

F.4.26 Primary variable trend

Fast Keys	3, 3, 1, 1
------------------	------------

This indicates the history of PV changes. Units are the selected PV Units (see [page 153](#)).

Note

- The live PV is indicated in the read-only parameter Process Value/Primary Variable (PV) ([page 193](#))

Field Communicator or AMS Device Manager

To view the trend

1. From the *Home* screen, select 3: Service Tools.
2. Select 3: Trends, and then select 1: Primary Variable (*twice*).
3. When finished, select EXIT to exit to the previous menu.

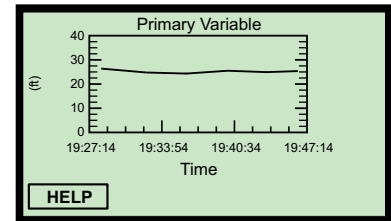

(Field Communicator Screen Shown)

Rosemount 3490 Series Control Unit

This feature is only available on the Field Communicator and AMS.

F.4.27 Temperature Trend

Fast Keys	3, 3, 2, 1
------------------	------------

This indicates the history of temperature changes. Units are in °C or °F depending on the base units selected (see [page 118](#)).

Note

- The live temperature is indicated in the read-only parameter Temperature/Fourth Variable (FV) ([page 196](#))

Field Communicator or AMS Device Manager

To view the trend

1. From the *Home* screen, select 3: Service Tools.
2. Select 3: Trends., and then select 2: Temperature.
3. Select 1: Temperature.
4. When finished, select EXIT to exit to the previous menu.

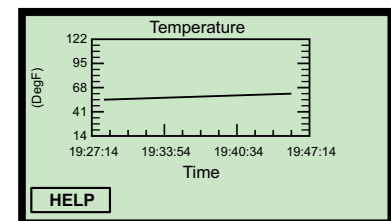

(Field Communicator Screen Shown)

Rosemount 3490 Series Control Unit

This feature is only available on the Field Communicator and AMS.

F.4.28 Distance and Echo Size Trend

Fast Keys	3, 3, 3, 1
------------------	------------

This indicates the history of distance and echo size changes. Distance units are in meters, feet, or inches depending on base units (see [page 118](#)).

Field Communicator or AMS Device Manager

To view the trend

1. From the *Home* screen, select 3: Service Tools.
2. Select 3: Trends.
3. Select 3: Distance / Echo Size (*twice*).
4. Select Distance (default) or Echo Size from the pull-down menu.
5. When finished, select EXIT to exit to the previous menu.

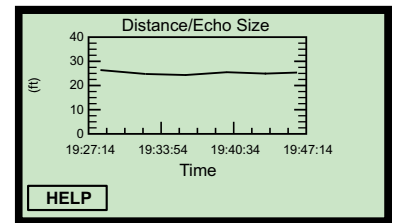

(Field Communicator Screen Shown)

Rosemount 3490 Series Control Unit

This feature is only available on the Field Communicator and AMS.

Index

Numerics

- 4 and 20 mA point parameters
 - 3101 LCD 28, 32
 - 3102/3105 LCD 48, 49, 54
 - HART 129, 159, 160

A

- Accessories 12, 13, 80, 90
- Accuracy of measurements 77
- Alarms and faults 24, 31, 51, 59,
..... 64, 79, 88, 89, 138, 172
- Ambient temperature parameter
 - 3102/3105 LCD 71
 - HART 176
- Ambient temperature range
 - Specification 81
- American and Canadian certifications 92
- AMS Suite
 - Intelligence Device Manager 6, 78, 112, 117
- Approval drawings 97
- ATEX approval 93
- ATEX Directive (94/9/EC) 91
- Auto tank map routine (HART) 124

B

- Base Units parameter
 - 3102/3105 LCD 74
 - HART 118
- Blanking distance or dead zone
 - 3102/3105 LCD 65
 - HART 110, 137, 138, 140, 177, 181, 182
- Bottom Reference 3, 4, 14, 15, 146
- Bottom Reference parameter
 - 3101 LCD 27
 - 3102/3105 LCD 38
 - HART 110, 119, 120, 124,
..... 136 – 138, 140, 142, 146, 148
- Bracket mounting 10, 12, 86, 90

C

- Cable entry 80, 84, 85, 87 – 90, 95, 96
- Cable specification 80
- Calibration for optional Remote Temperature Sensor
 - 3102/3105 LCD 72
- Calibration of 4 mA and 20 mA points (HART) 129
- Canadian Standards Association (CSA) approvals
..... 92, 93, 97, 99
- Clear False Echoes parameter (HART) 187
- Configuration tools 78
- Connecting the transmitter 16, 19

- Considerations before programming
 - the transmitter 25
- Contents (Volume) measurement
 - 3102/3105 LCD 24, 35, 36, 39, 40, 44, 47
 - HART 145
- Cover screws 5, 12, 16, 17, 34, 80
- Cover seal 17, 34, 55, 58, 80, 95
- Current Output 26, 30, 50, 61, 112, 125, 128,
..... 159, 160, 172, 189, 193, 197
- Cycle function (3102/3105 LCD) 61

D

- Damping parameter
 - 3101 LCD 30
 - 3102/3105 LCD 50
 - HART 162
- Descriptor parameter (HART) 133
- Detecting pump casings 11
- Detecting unwanted objects 10
- Diagnostics
 - 3101 LCD 58
 - 3102/3105 LCD 59, 105
 - HART 112
- Dimension drawings 84 – 86
- Display measurement units
 - 3101 LCD 26, 27
 - 3102/3105 LCD 36
 - HART 153
- Distance 199
- Distance / tertiary variable (TV) (HART) 195
- Distance offset parameter (HART) 141
- Distance to surface / target 27, 195
- Duty selection parameter (3102/3105 LCD) 35

E

- Echo size
 - 3101 LCD 27
 - 3102/3105 LCD 60
 - HART 200
- Echoes needed parameter (HART) 180
- Electrical installation 16 – 20
- Electrical parameters (3105) 79
- Electro Magnetic Compatibility (EMC) 82, 91
- Enclosed tank with a domed top 10
- Engineering menu (HART) 62
- Environmental considerations 9
- Error messages (3101 LCD) 58
- European certification 93
- European Union directives 91

F

Factory Mutual (FM) approvals	92, 93, 97, 98
False echo data parameters (HART)	186
False echoes	10, 11, 33, 34, 63, 69, 70, 111, 122, 124, 125, 181, 182, 186, 187
Fast keys (Field Commutator and AMS)	117
Field Communicator / DD menus	113, 114
Final checks	
3101	34
3102/3105	55
First measurements (3101)	27
Flange accessories	12, 13, 80
Flow measurement (3102/3105)	8, 14, 35, 36, 41, 77, 150, 151, 156, 193
Flow structure selection	42, 152
Foaming liquids	10, 58, 170, 200

G

General troubleshooting	
3101	58
3102/3105	59

H

HART Communications	6, 21, 189, 213, 216, 217
Hazardous locations certifications	93
Heavy condensation	10
Housing of transmitter	4

I

IECEX approval	94
Ingress protection	82
Installation considerations	8 – 10
Installation in a hazardous area / location	3, 9, 16, 17, 19, 21, 79, 89, 95, 96
Installing in a tank with a nozzle or stand-off	13
International certification	94
In-tank effects	11
Integral display (LCD)	24, 26, 33, 35, 39, 78

L

LCD	4
Learn routine	
3101	33
3102/3105	69
HART	122
Level / Secondary Variable (SV) (HART)	194
Level offset parameter (HART)	142
Lightning / surge protection	21
Liquid surface turbulence	11, 30, 50, 58, 162, 170, 200, 201
Loop test routine	
3102/3105 LCD	61
HART	128
Loop-current fixing (3102/3105)	61
Loop-powered	6

Lost echo action parameter	
3101 LCD	31
3102/3105 LCD	51
HART	172
Lost echo delay parameter	
3102/3105 LCD	64
HART	170
Lost echo time parameter (3102/3105 LCD)	64
Lower blanking parameter (HART)	140
Lower range value parameter (HART)	160

M

Manufacturing location	91
Material Safety Data Sheet (MSDS)	2
Max contents (volume) parameter (3102/3105 LCD)	47
Max flow level parameter (3102/3105 LCD)	45
Max flow rate parameter (3102/3105 LCD)	46
Mechanical installation	10
Menu and parameter maps	
3490 Series	109
Field Communicator DD	113
Integral Display	101 – 107
Message parameter (HART)	131
Monitoring and diagnostic parameters (HART)	193
Mounting considerations	10 – 13, 80, 86, 90

N

NEPSI China approval	94
Non-hazardous location certifications	92

O

Obstructions	10
On/Off points for relays (3102)	52
Operating frequency parameter (HART)	184, 205
Ordering information (model codes)	87 – 89
Output	
measurement units	78
variables	78

P

Percentage of current output (HART)	197
Poll address (HART)	189
Power factor setting for flow (3102/3105 LCD)	43
Power failure or disconnection	55
Power supply requirements	16, 19, 34, 92, 96
Present depth command (HART)	121
Pressure Equipment Directive (PED)	91
Primary Variable units parameter (HART)	153
Process pressure specification	81
Process temperature specification	81
Process Value (PV)	24, 26, 39, 41, 50 – 52, 110, 119, 125, 128, 143, 145, 147, 150, 153, 154, 156, 158 – 160, 163, 165 – 169, 172, 193, 202, 218

Product 91
Profile height / power factor parameter (HART)... 156
Profile options for flow 42
Profile points 1 to 10 parameters (HART)... 158
Profile selection
 3102/3105 LCD 39
 HART 145, 152
Programming the 3102 and 3105 using HART.... 117
Pulse repeat parameter
 3102/3105 LCD 67
 HART 162, 179

R

Recycling..... 2
Relays 3, 19, 24, 53, 55, 61,
 77, 79, 88, 110, 163, 165 – 169
Remote Temperature Sensor (RTS) . 15, 18, 20, 21, 90
Restore factory default settings
 3102/3105 LCD 73
 HART 127
Return Material Authorization (RMA) number 2
Rosemount 3490 Series Control Unit
 3, 6, 78, 83, 117, 137, 146, 148, 150, 151

S

Safety
 considerations 8
 instructions for ATEX and IECEx IS approvals ... 95
 messages 1, 7, 23, 57
Scaling factor parameter
 3102/3105 LCD 44
 HART 154
Separate extra-low voltage (SELV) 16, 92
Serial number (HART) 135
Service and troubleshooting..... 57
Service support 2
Servicing 58
Set as empty command (HART) 120
Set threshold parameter (HART) 177
Simulate current output (HART)..... 128
Simulation of PV (HART) 125
Speed of Sound..... 71, 110, 112, 137, 174, 176
Speed of Sound parameter (HART)..... 174
Spike rejection parameter (HART) 185
Spike rejection setting (3102/3105 LCD) 69
Stirrers or agitators 11
Sun-shade 10
System architecture 6

T

Tag parameter (HART) 132
Tank geometry 137
Tank shape / non-linear profile parameter (HART).. 143
Tanks with rounded or conical bottoms..... 11
Temperature / fourth variable (FV) (HART) 196
Temperature compensation..... 81

Theory of operation 4
Thread form 12, 80
Threshold parameter for false echo rejection
 3102/3105 LCD 63
Transducer body seal 80
Transmit power control (HART) 178
Transmitter face 4, 5, 10, 13, 27,
 58, 65, 138, 146, 172, 181, 182, 199, 202
Trending (HART)..... 218, 219
Typical application 3

U

Update interval 78
Upper blanking parameter (HART)..... 138
Upper range value parameter (HART) 159

V

Valid echo count parameter (3102/3105 LCD) 68

W

Weight of transmitters 80
Wet-side material 80

Rosemount World Headquarters

Emerson Process Management

6021 Innovation Blvd

Shakopee, MN 55379, USA

+1 800 999 9307 or +1 952 906 8888

+1 952 949 7001

RFQ.RMD-RCC@EmersonProcess.com

North America Regional Office

Emerson Process Management

8200 Market Blvd.

Chanhassen, MN 55317, USA

+1 800 999 9307 or +1 952 906 8888

+1 952 949 7001

RMT-NA.RCCRFQ@Emerson.com

Latin America Regional Office

Emerson Process Management

1300 Concord Terrace, Suite 400

Sunrise, Florida, 33323, USA

+1 954 846 5030

+1 954 846 5121

RFQ.RMD-RCC@EmersonProcess.com

Europe Regional Office

Emerson Process Management Europe GmbH

Neuhofstrasse 19a P.O. Box 1046

CH 6340 Baar

Switzerland

+41 (0) 41 768 6111

+41 (0) 41 768 6300

RFQ.RMD-RCC@EmersonProcess.com

Asia Pacific Regional Office

Emerson Process Management Asia Pacific Pte Ltd

1 Pandan Crescent

Singapore 128461

+65 6777 8211

+65 6777 0947

Enquiries@AP.EmersonProcess.com

Middle East and Africa Regional Office

Emerson Process Management

Emerson FZE P.O. Box 17033,

Jebel Ali Free Zone - South 2

Dubai, United Arab Emirates

+971 4 8118100

+971 4 8865465

RFQ.RMTMEA@Emerson.com

Standard Terms and Conditions of Sale can be found at:

www.rosemount.com/terms_of_sale.

The Emerson logo is a trademark and service mark of Emerson Electric Co.

Rosemount and Rosemount logotype are registered trademarks of Rosemount Inc.

All other marks are the property of their respective owners.

© 2015 Rosemount, Inc. All rights reserved.

ROSEMOUNT®

EMERSON™
Process Management