

# Micro Motion<sup>®</sup> 5700 Transmitters with MVD<sup>™</sup> Technology



## Repeatable, reliable, accurate measurements

- Faster processing speed delivers the best response even in the most challenging applications such as meter proving, filling & dosing, and batching
- Smart Meter Verification provides you with the confidence you need in your meter performance
- Zero verification confirms the calibration and indicates when it's time to re-zero the meter
- Approved for custody transfer and certified for SIL2 and SIL3, which provides measurement confidence and reliability

## A window into your process

- Easy access to detailed measurement history gives you valuable insight into your process for better troubleshooting and optimization
- Real-time indication of multi-phase flow events allow for greater process control
- High-accuracy density measurement reduces or eliminates waste in your process while the embedded historian records upsets and process deviations

## Productivity through simplified solutions

- Designed to minimize the time and expertise needed to install and operate the flowmeter
- Up to five fully configurable input/output channels that can be easily upgraded with changing needs
- Ethernet version includes multiple protocols on dual channels, plus a configurable I/O channel
- FOUNDATION<sup>™</sup> Fieldbus version includes IEC-61158-2 FOUNDATION Fieldbus output, a fixed mA Output channel, and a configurable Frequency / Discrete Output channel.
- Up to four configurable intrinsically safe output channels that can easily be upgraded with changing needs
- Offline configuration and auditing through new file shuttling capability

## Micro Motion 5700 transmitters

The 5700 transmitters deliver the best measurement technology and offer unparalleled support – ensuring total measurement confidence, valuable process insight and greater operational efficiency. These transmitters provide the scalability, compatibility and performance that your application demands.

### Simplified installation and commissioning

An intuitive interface, spacious side-access wiring compartment and convenient mounting brackets.

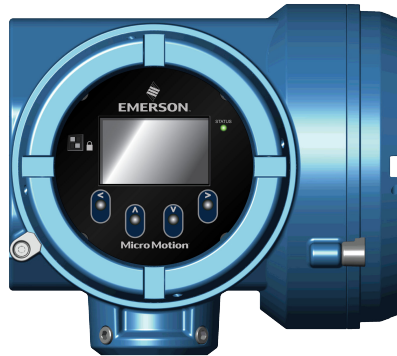

### Smart Meter Verification: advanced diagnostics for your entire system

Our online tool verifies that your meter performs as well as the day it was installed, giving you assurance in less than 90 seconds.



### Measurement history for easier troubleshooting and optimization

Detailed history files deliver key time-stamped information about your process from configuration changes and alerts to process events and statistics.

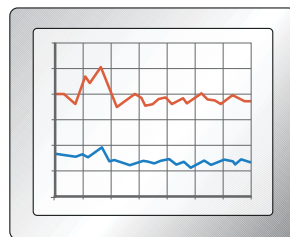

**Unmatched system connectivity and services interfaces**

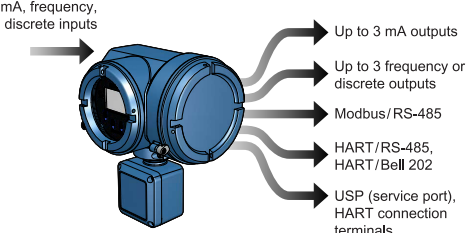
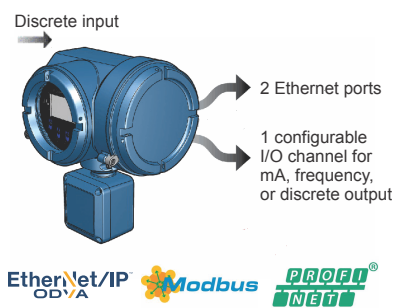
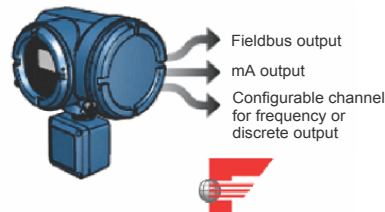
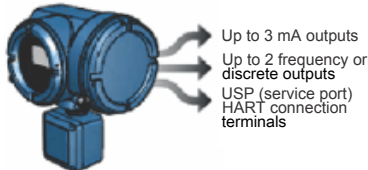
<p>Configurable I/O version</p>	<p>Up to five fully configurable I/O channels with multiple mA, Discrete and Frequency Outputs, and several powerful service interfaces.</p> 
<p>Ethernet version</p>	<p>Two Ethernet outputs with EtherNet/IP, Modbus TCP, or PROFINET — plus one configurable output.</p> 
<p>Fieldbus version</p>	<p>Fieldbus output, mA Output, and a configurable channel for Frequency or Discrete Output.</p> 
<p>Intrinsically safe outputs version</p>	<p>Up to four fully configurable output channels with up to three mA, and two Discrete and Frequency Outputs.</p> 

## 5700 enhancements

### Internal memory

The 5700 transmitter provides a backup of:

- Transmitter configurations

- Meter verification baseline and history
- Data log
- Licensing key

If you need to replace your transmitter, move your old memory to the new transmitter without losing any data or licensing information.

### Software licensing

Software licensing makes it possible to:

- Purchase permanent features and add them later
- Trial features, such as concentration measurement, for 60 days before buying
- Order up to five input/output channels through the license

### Large graphical display

- Supports multiple languages
- Supports full configuration capabilities directly from the display
- Provides understandable alert codes

### Two-phase flow detection

Two-phase flow detection provides clear, concise information about fluid conditions, including notification about the following three fluid regimes:

- Single phase
- Moderate two-phase flow
- Severe two-phase flow

### Physical design

- Conduit and terminal compartments are accessible from the sides
- Modular board stack design
- Spacious wiring compartments
- Remote mounting bracket
- A Universal Service Port (USP) connects and transfers data using standard, easily available equipment

### Troubleshooting tools

The 5700 transmitter stores data in non volatile memory with Real Time Clock, including:

- Audit trail
- Alert log
- Long term data historian: 5-minute Min, Max, Avg, Std Dev (10 years)
- Short term data historian: 1-second data (30 days)

The 5700 transmitter contains descriptive alerts describing the issue and recommended steps for resolution.

- Follows NE 107 Standard

## Applications

Applications are custom designed programs and software that offer additional functionality and performance to transmitters. These applications are available through options in the transmitter model code, see the ordering information section for details.

### Smart Meter Verification

Provides a quick, complete assessment of a Micro Motion Coriolis meter, determining whether the meter has been affected by erosion, corrosion, or other influences affecting meter calibration. No secondary references are required to perform this operation, and the meter can continue normal process measurement while the test is in progress.

Smart Meter Verification Professional on the 5700 transmitter also offers coating detection, installation verification, detection of optimal flow range, and two-phase flow detection. A 90-day trial version is included with all 5700 transmitters with enhanced core processors. After the 90-day trial, a basic version of Smart Meter Verification will provide simple pass/fail results, and simple diagnostics that run without interrupting your processes.

### Discrete batch control

- Simple batch control based on totalizer values
- Frequency Output configured as Discrete Output for transmitters with analog or intrinsically safe outputs
- Automatic overshoot compensation
- Single and dual stage batching available on the configurable I/O and intrinsically safe versions when ordered with the Batching Software (BS) package option
- Optional constant batch mode provides a simplified batch screen flow, and stays in this mode until a password is entered to exit mode, in addition to standard batch
- Batch ticket printing available if Channel E is enabled (supports Terminal Window, Generic, Epson TM88v, Epson TMU-295 and Digitec 6610A printers)
- Batch ticket printing available with Ethernet (supports Epson TM88VI)

---

#### Note

Discrete batch control is not available with 5700 FOUNDATION Fieldbus.

---

### Petroleum measurement and API correction option

- Accepts inputs from temperature and pressure devices
- Calculates values as per May, 2004 API Chapter 11.1
  - Relative density (specific gravity and API gravity) at reference temperature from observed density and temperature
  - Volume corrected to reference temperature and pressure
- Calculates flow-weighted average temperature and flow-weighted average observed density (specific gravity and API gravity)

### Concentration measurement

Provides concentration measurement based on either industry-specific or liquid-specific units and relationships. Standard measurement options include:

- Industry-specific:
  - °Brix
  - °Plato
  - °Balling
  - °Baumé at SG60/60
  - Specific gravity
- Liquid-specific:
  - %HFCS

- Concentration derived from reference density
- Concentration derived from specific gravity

Additionally, the application can be customized for site-specific concentration measurement (such as %HNO<sub>3</sub>, %NaOH).

### Advanced Phase Measurement

- Accurately measures liquid or gas flow in limited multiple-phase conditions
  - Immediate and continuous access to production or process data
  - Real time reporting of Gas Void Fraction (GVF)
- Facilitates reliable measurement at a fraction of the cost of true multi-phase meters
  - Historian automatically captures all production data
  - Little to no maintenance or calibration
- Combines with Net Oil Computer (NOC) or concentration measurement to measure two liquids in the presence of gas
  - Provides single-well and multi-well real-time Net Oil and Net Water measurements
  - Improves concentration measurement in processes with intermittent entrained gas

### Piecewise Linearization (PWL) for enhanced gas applications

- Provides gas calibration enhancement capability for industry-leading gas measurement performance
- Designed specifically for midstream natural gas fiscal metering applications

Third-party gas calibration services are not included.

## Electrical connections

### Electrical isolation

For all 5700 versions, each I/O channel is isolated +/-50VDC from all other outputs and earth ground.

### Configurable I/O version

Connection	Description
Input/Output	Up to five pairs of wiring terminals for transmitter I/O and communications
Power	<ul style="list-style-type: none"> <li>■ One pair of wiring terminals accepts AC or DC power</li> <li>■ One internal ground lug for power-supply ground wiring</li> </ul>
Sensor	<ul style="list-style-type: none"> <li>■ 4-wire remote mount – 4 terminals for connection to 4-wire sensor</li> <li>■ 9-wire remote mount – 9 terminals for connection to 9-wire sensor</li> </ul>
Service port (HART)	Two clips for temporary connection to the service port
Universal Service Port (USP)	A USP connected to commercially-available USB equipment and cables

### Ethernet version

Connection	Description
Ethernet ports	Two Ethernet ports for EtherNet/IP, Modbus TCP, PROFINET, and web server connections
Input/Output	One configurable channel for mA Output, Frequency Output, Discrete Output, or Discrete Input

Connection	Description
Power	<ul style="list-style-type: none"> <li>■ One pair of wiring terminals accepts AC or DC power</li> <li>■ One internal ground lug for power-supply ground wiring</li> </ul>
Sensor	<ul style="list-style-type: none"> <li>■ 4-wire remote mount – 4 terminals for connection to 4-wire sensor</li> <li>■ 9-wire remote mount – 9 terminals for connection to 9-wire sensor</li> </ul>
Universal Service Port (USP)	A USP connected to commercially-available USB equipment and cables
Embedded web server	<ul style="list-style-type: none"> <li>■ Connects to embedded web server via Ethernet connection for on-board configuration or data transfer</li> <li>■ Supports secure web server connection with default Self-Signed Certificate and optional support for Certificate Authority</li> </ul>

### FOUNDATION Fieldbus version

Connection	Description
Input/Output	<ul style="list-style-type: none"> <li>■ One channel for mA Output</li> <li>■ One configurable channel for Frequency Output or Discrete Output These outputs are available as intrinsically safe, or non-intrinsically safe, based on the output option selected.</li> </ul>
Power	<ul style="list-style-type: none"> <li>■ One pair of wiring terminals accepts AC or DC power</li> <li>■ One internal ground lug for power-supply ground wiring</li> </ul>
Sensor	<ul style="list-style-type: none"> <li>■ 4-wire remote mount – 4 terminals for connection to 4-wire sensor</li> <li>■ 9-wire remote mount – 9 terminals for connection to 9-wire sensor</li> </ul>
Universal Service Port (USP)	A USP connected to commercially-available USB equipment and cables

### Intrinsically safe outputs version

Connection	Description
Output	Up to four pairs of wiring terminals for transmitter outputs and communications
Power	<ul style="list-style-type: none"> <li>■ One pair of wiring terminals accepts AC or DC power</li> <li>■ One internal ground lug for power-supply ground wiring</li> </ul>
Sensor	<ul style="list-style-type: none"> <li>■ 4-wire remote mount – 4 terminals for connection to 4-wire sensor</li> <li>■ 9-wire remote mount – 9 terminals for connection to 9-wire sensor</li> </ul>
Service port (HART)	Two clips for temporary connection to the service port
Universal Service Port (USP)	A USP connected to commercially-available USB equipment and cables

#### Note

- Each screw terminal connection accepts one or two solid conductors, 24 AWG (0.205 mm<sup>2</sup>) to 12 AWG (3.31 mm<sup>2</sup>) or one or two stranded conductors, 22 AWG (0.326 mm<sup>2</sup>) to 14 AWG (2.08 mm<sup>2</sup>). Each plug type connector accepts one stranded or solid conductor, 24 AWG (0.205 mm<sup>2</sup>) to 12 AWG (3.31 mm<sup>2</sup>).
- For integral mount transmitters (mounting code I), the connection between the transmitter and the sensor is not normally accessed.

# Input/output signal detail

## Configurable I/O channels (output board code A)

Signal	Channel A		Channel B		Channel C		Channel D		Channel E	
Wiring terminals	1	2	3	4	5	6	7	8	9	10
mA Inputs and Outputs	mA Output 1 (HART)		mA Output 2		mA Output 3		mA Input		RS-485	
Frequency Outputs			Frequency Output 2 <sup>(1)</sup>		Frequency Output 1		Frequency Output 2 <sup>(1)</sup>			
Discrete Outputs			Discrete Output 1		Discrete Output 2		Discrete Output 3			
Discrete Inputs					Discrete Input 1		Discrete Input 2			
Frequency Inputs							Frequency Input			

(1) Frequency Output 2 can be mapped to Channel B or D. For multiple Frequency Outputs, use Frequency 1 on Channel C and Frequency 2 on either Channel B or D.

## Ethernet channels (output board code C)

Signal	Channel A	Channel B	Channel C
Channel options	EtherNet/IP <sup>(1)</sup>	EtherNet/IP	mA Output
	Modbus TCP	Modbus TCP	Frequency Output
	PROFINET	PROFINET	Discrete Output
			Discrete Input

(1) The same protocol must be ordered on both Channel A and B. ProLink III and the Integrated Webserver can always be connected to either Channel A or B.

## FOUNDATION Fieldbus channels (output board code E with intrinsically safe H1 outputs)

Signal	Channel A	Channel C	Channel D
Channel options	FOUNDATION Fieldbus (FISCO “ia” or FISCO “ic”)	IS mA Output	IS Frequency Output
			IS Discrete Output

## FOUNDATION Fieldbus channels (output board code N with H1 outputs)

Signal	Channel A	Channel C	Channel D
Channel options	FOUNDATION Fieldbus	mA Output	Frequency Output
			Discrete Output

## Intrinsically safe output channels

Signal	Channel A		Channel B		Channel C		Channel D	
Wiring terminals	1	2	3	4	5	6	7	8



Signal	Channel A	Channel B	Channel C	Channel D
mA Outputs	mA Output (1) (HART)	mA Output (2)	mA Output (3)	
Frequency Outputs			Frequency Output (1)	Frequency Output (2)
Discrete Outputs			Discrete Output (1)	Discrete Output (2)

## Channel A specifications

### Configurable I/O (output board code A)

Specification	mA Output
Downscale fault	Configurable from 1.0 – 3.6mA, default value = 2.0mA
External voltage (passive power)	Maximum: 30VDC Maximum loop resistance: 1080 ohm @ 30VDC
Internal voltage (active power)	Nominal: 24VDC
Linearity	0.015 % Span, Span = 16mA
Scalable range	4-20mA
Upscale fault	Configurable from 21.0 – 23.0mA, default value = 22.0mA

#### Note

mA Output is linear with process from 3.8 to 20.5 mA, per NAMUR NE-43 (February 2003).

### Ethernet (output board code C)

Specifications:

- 10BASE-T
- 100BASE-TX

### FOUNDATION Fieldbus (output board code E)

Specifications:

- FOUNDATION Fieldbus H1 output
- Wiring is intrinsically safe with intrinsically safe power supply
- Transmitter fieldbus circuit is passive, and draws power from the fieldbus segment – current draw is 13 mA
- Manchester encoded digital signal conforms to IEC 61158-2

### FOUNDATION Fieldbus (output board code N)

Specifications:

- FOUNDATION Fieldbus H1 output
- FOUNDATION Fieldbus wiring is non-incendive
- Transmitter fieldbus circuit is passive, and draws power from the fieldbus segment – current draw is 13 mA
- Manchester encoded digital signal conforms to IEC 61158-2

**Intrinsically safe (output board code D)**

Specification	mA Output
Downscale fault	Configurable from 3.2 – 3.6mA, default value = 3.2mA
Entity parameters	U <sub>i</sub> = 30V I <sub>i</sub> = 484mA P <sub>i</sub> = 2.05W C <sub>i</sub> = 150pF L <sub>i</sub> = 0uH
External voltage (passive power)	Minimum: 8VDC Maximum: 30VDC Maximum loop resistance: 917 ohm @ 30VDC
Linearity	0.020 % Span, Span = 16mA
Scalable range	4-20mA
Upscale fault	Configurable from 21.0 – 23.0mA, default value = 22.0mA

**Channel B specifications****Configurable I/O (output board code A)**

Specification	mA Output	Frequency Output (2)	Discrete Output (1)
Internal voltage (active power)	Nominal: 24VDC Maximum loop resistance: 820 ohm	Nominal: 24VDC Sourcing: 22mA	Nominal: 24VDC Sourcing: 7mA sourcing
External voltage (passive power)	Maximum: 30VDC Maximum loop resistance: 1080 ohm @ 30VDC	Maximum: 30VDC Maximum sinking: 500mA	Maximum: 30VDC Maximum sinking: 500mA
Scalable range	4-20mA	0.01 Hz – 10 kHz	
Downscale fault	Configurable from 1.0 – 3.6 mA, default value = 2.0 mA	0Hz	
Upscale fault	Configurable from 21.0 – 23.0 mA, default value = 22.0 mA	Configurable from 10 Hz to 14.5 kHz, default value = 14.5 kHz	
Linearity	0.015 % Span, Span = 16mA	Output is linear with flow rate to 12.5 kHz	
Resolution		+/- 1 pulse	

**Ethernet (output board code C)**

Specifications:

- 10BASE-T
- 100BASE-TX

**FOUNDATION Fieldbus****Table 1: Output board code E**

Specification	mA Output
External voltage (passive power)	Minimum: 10VDC Maximum: 30VDC Maximum loop resistance: 869 ohms @ 30V
Scalable range	4-20mA
Downscale fault	Configurable from 1.0 – 3.6 mA, default value = 2.0 mA
Upscale fault	Configurable from 21.0 – 23.0 mA, default value = 22.0 mA
Linearity	0.015 % Span, Span = 16mA
Entity parameters	U <sub>i</sub> = 30V I <sub>i</sub> = 484mA P <sub>i</sub> = 2.05W C <sub>i</sub> = 0.27nF L <sub>i</sub> = 5uH

**Table 2: Output board code N**

Specification	mA Output
External voltage (passive power)	Minimum: 10VDC Maximum: 30VDC Maximum loop resistance: 869 ohms @ 30V
Scalable range	4-20mA
Downscale fault	Configurable from 1.0 – 3.6 mA, default value = 2.0 mA
Upscale fault	Configurable from 21.0 – 23.0 mA, default value = 22.0 mA
Linearity	0.015 % Span, Span = 16mA

**Note**

mA Output is linear with process from 3.8 to 20.5 mA, per NAMUR NE-43 (February 2003).

**Intrinsically safe (output board code D)**

Specification	mA Output
External voltage (passive power)	Minimum: 8VDC Maximum: 30VDC Maximum loop resistance: 917 ohm @ 30VDC
Scalable range	4-20mA
Downscale fault	Configurable from 3.2 – 3.6 mA, default value = 3.2 mA
Upscale fault	Configurable from 21.0 – 23.0 mA, default value = 22.0 mA
Linearity	0.020 % Span, Span = 16mA

## Channel C specifications

### Configurable I/O (output board code A) and Ethernet (output board code C)

Specification	mA Output	Frequency Output <sup>(1)</sup>	Discrete Output <sup>(2)</sup>	Discrete Input
Internal voltage (active power)	Nominal: 24VDC Maximum loop resistance: 820 ohm	Nominal: 24VDC Sourcing: 22mA	Nominal: 24VDC Sourcing: 7mA	Nominal: 24VDC Sourcing: 7mA
External voltage (passive power)	Maximum: 30VDC Maximum loop resistance: 1080 ohm @ 30VDC	Maximum: 30VDC Maximum sinking: 500mA	Maximum: 30VDC Maximum sinking: 500mA	Maximum: 30VDC
Scalable range	4-20mA	0.01 Hz – 10 kHz		
Downscale fault	Configurable from 1.0 – 3.6 mA, default value = 2.0 mA	0Hz		
Upscale fault	Configurable from 21.0 – 23.0 mA, default value = 22.0 mA	Configurable from 10 Hz to 14.5 kHz, default value = 14.5 kHz		
Resolution		+/- 1 pulse		
Linearity	0.015 % Span, Span = 16mA	Output is linear with flow rate to 12.5 kHz		
Maximum positive threshold				3VDC
Minimum negative threshold				0.6VDC

(1) Load resistor (500 Ω resistance recommended for 24V supply.) Use the following equations for other load resistance values:  $R_{max} = [(V_{supply} - 6V) / 0.003] - R_{barrier}$  (maximum value of load resistor allowed)  $R_{min} = 0$  ohms

(2)  $Current = (V_{supply} - 0.8V) / (1690 \text{ ohms} + barrier \text{ internal resistance in ohms} + load \text{ resistor in ohms})$

#### Note

mA Output is linear with process from 3.8 to 20.5 mA, per NAMUR NE-43 (February 2003).

### FOUNDATION Fieldbus (output code E)

Specification	Frequency Output <sup>(1)</sup>	Discrete Output <sup>(2)</sup>
External voltage (passive power)	Maximum: 30VDC Minimum: 8VDC	Maximum: 30VDC Minimum: 8VDC
Scalable range	0.01 Hz - 10 kHz	
Downscale fault	0Hz	
Upscale fault	Configurable from 10 Hz to 14.5 kHz, default value = 14.5 kHz	
Resolution	+/- 1 pulse	

Specification	Frequency Output <sup>(1)</sup>	Discrete Output <sup>(2)</sup>
Entity parameters	U <sub>i</sub> = 30V I <sub>i</sub> = 484mA P <sub>i</sub> = 2.05W C <sub>i</sub> = 11.27nF L <sub>i</sub> = 5uH	

- (1) Load resistor (500 Ω resistance recommended for 24V supply.) Use the following equations for other load resistance values:  $R_{max} = [(V_{supply} - 6V) / 0.003] - R_{barrier}$  (maximum value of load resistor allowed)  $R_{min} = 0$  ohms  
 (2)  $Current = (V_{supply} - 0.8V) / (1690 \text{ ohms} + barrier \text{ internal resistance in ohms} + load \text{ resistor in ohms})$

**FOUNDATION Fieldbus (output code N)**

Specification	Frequency Output <sup>(1)</sup>	Discrete Output <sup>(2)</sup>
External voltage (passive power)	Maximum: 30VDC Minimum: 8VDC <sup>(3)</sup>	Maximum: 30VDC Minimum: 8VDC <sup>(4)</sup>
Scalable range	0.01 Hz - 10 kHz	
Downscale fault	0Hz	
Upscale fault	Configurable from 10 Hz to 14.5 kHz, default value = 14.5 kHz	
Resolution	+/- 1 pulse	

- (1) Load resistor (500 Ω resistance recommended for 24V supply.) Use the following equations for other load resistance values:  $R_{max} = [(V_{supply} - 6V) / 0.003] - R_{barrier}$  (maximum value of load resistor allowed)  $R_{min} = 0$  ohms  
 (2)  $Current = (V_{supply} - 0.8V) / (1690 \text{ ohms} + barrier \text{ internal resistance in ohms} + load \text{ resistor in ohms})$   
 (3) Load resistor (500 Ω resistance recommended for 24V supply.) Use the following equations for other load resistance values:  $R_{max} = [(V_{supply} - 6V) / 0.003]$  (maximum value of load resistor allowed)  $R_{min} = 250$  ohms (minimum value of load resistance required)  
 (4)  $Current = (V_{supply} - 0.8V) / (1690 \text{ ohms} + load \text{ resistor in ohms})$

**Intrinsically safe (output board code D)**

Specification	mA Output	Frequency Output <sup>(1)</sup>	Discrete Output
External voltage (passive power)	Maximum: 30VDC Maximum: 30VDC Maximum loop resistance: 917 ohm @ 30VDC	Maximum: 30VDC	Maximum: 30VDC
Scalable range	4-20mA	0.01 Hz – 10 kHz	
Downscale fault	Configurable from 3.2 – 3.6 mA, default value = 3.2 mA	0Hz	
Upscale fault	Configurable from 21.0 – 23.0 mA, default value = 22.0 mA	Configurable from 10 Hz to 14.5 kHz, default value = 14.5 kHz	
Accuracy		+/- 1 pulse	
Linearity	0.015 % Span Span = 16mA	Output is linear with flow rate to 12.5 kHz	

- (1) Load resistor (500 Ω resistance recommended for 24V supply.)

**Note**

mA Output is linear with process from 3.8 to 20.5 mA, per NAMUR NE-43 (February 2003).

## Channel D specifications

Channel D specifications do not apply to Ethernet or FOUNDATION Fieldbus implementations.

### Configurable I/O (output board code A)

Specification	Frequency Output (2)	mA Input	Discrete Output (3)	Discrete Input (2)	Frequency Input
Internal voltage (active power)	Nominal: 24VDC 2.21 kilo ohm pull-up resistor	Nominal: 24VDC	Nominal: 24VDC 2.21 kilo ohm pull-up resistor	Nominal: 24VDC 2.21 kilo ohm pull-up resistor	Nominal: 24VDC 2.21 kilo ohm pull-up resistor
External voltage (passive power)	Maximum: 30VDC Maximum sinking: 500mA	Maximum: 30VDC	Maximum: 30VDC Maximum sinking: 500mA	Maximum: 30VDC	Maximum: 30VDC
Scalable range	0.01 Hz – 10 kHz	4 - 20 mA Fault indication if mA Input drops below 3.8 mA or goes above 20.5 mA			
Downscale fault	0Hz				
Upscale fault	Configurable from 10 Hz to 14.5 kHz, default value = 14.5 kHz				
Accuracy	+/- 1 pulse				
Input resistance		100 ohm			
Max frequency				100 Hz	3500 Hz
Maximum positive threshold				3VDC	3VDC
Minimum negative threshold				0.6VDC	0.6VDC

### Intrinsically safe (output board code D)

Specification	Frequency Output (2)	Discrete Output (2)
External voltage (passive power)	Maximum: 30VDC	Maximum: 30VDC
Scalable range	0.01 Hz – 10 kHz	
Downscale fault	0Hz	
Upscale fault	Configurable from 10 Hz to 14.5 kHz, default value = 14.5 kHz	
Accuracy	+/- 1 pulse	

## Channel E specifications

Channel E is not available for Ethernet, FOUNDATION fieldbus, or intrinsically safe configurations.

Output option	Specification
Configurable I/O (output board code A)	RS-485 Modbus

### Sensor input mounting codes

Mounting codes	Description
I (integral mount)	Integrally mounted to sensor, no external input connection
C (9-wire remote mount)	One 9-wire sensor signal input connection, intrinsically safe
R (4-wire remote mount)	One 4-wire sensor signal input connection, intrinsically safe

## Digital communications

Protocols	Outputs and descriptions
Modbus/USP	<ul style="list-style-type: none"> <li>■ One service port that can be used for a temporary connection only</li> <li>■ Connects to a PC via USB as if the transmitter had a built-in USB/RS-485 converter</li> <li>■ Supports all Modbus data rates</li> <li>■ Requires a USB A/male-to-A/male cable                             <ul style="list-style-type: none"> <li>— A 4 ft (1.22 m) cable is supplied with each meter</li> </ul> </li> </ul>
Modbus/RS-485,HART/RS-485	<ul style="list-style-type: none"> <li>■ Available on Channel E, if purchased</li> <li>■ One RS-485 output can be used for direct connection to HART or Modbus host systems</li> <li>■ Accepts data rates between 1200 baud and 38.4 kilobaud</li> <li>■ 115.2 kilobaud is also available as a special order item</li> <li>■ Uses the latest HART 7 standard</li> </ul>
HART/Bell 202	<ul style="list-style-type: none"> <li>■ Available on Channel A, if purchased</li> <li>■ HART Bell 202 signal is superimposed on the primary milliamp output, and is available for host system interface</li> <li>■ Requires 250 to 600 ohms load resistance</li> <li>■ Uses the latest HART 7 standard</li> </ul>
FOUNDATION Fieldbus	<ul style="list-style-type: none"> <li>■ Available on Channel A</li> <li>■ Models/output codes:                             <ul style="list-style-type: none"> <li>— 5700 with output code E is FISCO “ia” certified in Zone 1 / Div 1 and is FISCO “ic” certified in Zone 2 / Div 2 (formerly known as FNICO)</li> <li>— 5700 with output code N</li> </ul> </li> <li>■ Transmitters are registered with the Fieldbus Foundation, and conform to the FOUNDATION Fieldbus H1 protocol specification.</li> <li>■ FISCO:                             <ul style="list-style-type: none"> <li>— Field device in compliance with EN 60079-11:2012 and IEC 60076-11:2011</li> <li>— <math>U_i = 33\text{ V}</math>, <math>I_i = 380\text{ mA}</math>, <math>P_i = 5.32\text{ W}</math>, <math>C_i = 0.27\text{ nF}</math>, <math>L_i = 5\text{ }\mu\text{H}</math></li> </ul> </li> </ul>

Protocols	Outputs and descriptions
EtherNet/IP/Ethernet	<ul style="list-style-type: none"> <li>■ Available on Channel A and Channel B</li> <li>■ Supports Auto Negotiate with data rates of 10 MB and 100 MB and half and full duplex</li> <li>■ Supports Auto Detect of Ethernet Crossover cables</li> <li>■ Supports Dynamic Host Configuration Protocol (DHCP)</li> <li>■ Supports Device Level Ring (DLR)</li> <li>■ Supports Address Conflict Detection (ACD)</li> <li>■ Supports Quality of Service (QoS)</li> <li>■ Supports file object for EDS download</li> <li>■ Conforms to ODVA EtherNet/IP Specification CT 12</li> <li>■ Conforms to the 10BASE-T and 100BASE-TX Ethernet standards</li> <li>■ Supports secure web server connection with default Self-Signed Certificate and optional support for Certificate Authority</li> </ul>
Modbus TCP/Ethernet	<ul style="list-style-type: none"> <li>■ Available on Channel A and Channel B</li> <li>■ Supports Auto Negotiate with data rates of 10 MB and 100 MB and half and full duplex</li> <li>■ Supports Auto Detect of Ethernet Crossover cables</li> <li>■ Supports Dynamic Host Configuration Protocol (DHCP)</li> <li>■ Uses v1.1b of the Modbus TCP standard</li> <li>■ Conforms to the 10BASE-T and 100BASE-TX Ethernet standards</li> <li>■ Supports secure web server connection with default Self-Signed Certificate and optional support for Certificate Authority</li> </ul>
PROFINET/Ethernet	<ul style="list-style-type: none"> <li>■ Available on Channel A and Channel B</li> <li>■ Supports Auto Negotiate with data rates of 10 MB and 100 MB and half and full duplex</li> <li>■ Supports Auto Detect of Ethernet Crossover cables</li> <li>■ Conforms to Conformance Class A v2.31 standard</li> <li>■ Conforms to the 10BASE-T and 100BASE-TX Ethernet standards</li> <li>■ Supports secure web server connection with default Self-Signed Certificate and optional support for Certificate Authority</li> </ul>

## The 5700 with FOUNDATION Fieldbus support

### Fieldbus software functionality

The 5700 FOUNDATION Fieldbus software is designed to permit remote testing and configuration of the transmitter using the DeltaV™ Fieldbus Configuration Tool, or other FOUNDATION Fieldbus compliant hosts. The Coriolis sensor signal is channeled through the flowmeter to the control room and the FOUNDATION Fieldbus configuration device.

### Transducer blocks

Transducer blocks hold data from the Coriolis sensor, including process variables, configuration, calibration, and diagnostics.



The 5700 transmitter with FOUNDATION Fieldbus provides up to seven transducer blocks:

- Measurement - For process and diagnostic variables and configuration of process parameters.
- Device - For device, display, channels configuration and device alert information
- Total inventory - For configuration of device totals and inventories
- Meter Verification - For Smart Meter Verification
- API referral - For petroleum measurement calculations using API MPMS Chapter 11.1
- Concentration measurement
  - For complex density and concentration calculations (e.g.,%HFCS, SG60/60)
- APM - For Advance Phase Measurement and NOC calculations

### Resource block

The resource block contains physical device information, including available memory, manufacturer identification, type of device, and features.

### Analog input function blocks

The Analog Input (AI) function block processes the measurement from the Coriolis sensor and makes it available to other function blocks. It also allows filtering, alarm handling, and engineering unit changes. Each of the 4 5700 AI blocks can be assigned to one of 27 available variables. There are four permanent Analog Input function blocks.

### Analog output function blocks

The AO function block assigns an output value to a field device through a specified channel. The block supports mode control, signal status calculation, and simulation. The AO block can report pressure from an external pressure source, temperature from an external temperature source, or watercut from an external device. There are two permanent Analog output function blocks.

### Discrete Input function block

One permanent Discrete Input (DI) function block can be assigned to any of the Discrete Input variable channels in the transducer block. The DI block channels are: forward/reverse indication, zero in progress, fault condition indication, and meter verification failure.

### Discrete Output function block

One permanent Discrete Output (DO) function block can be assigned to any of the Discrete Output variable channels in the transducer block. The DO block channels are: Start Sensor Zero, Increment CM Curve, Start Meter Verification in Continuous Measurement Mode, Reset All Process Totals, Start/Stop All Totals, Reset Config Totals 1-7.

### Proportional integral derivative function block

One permanent Proportional Integral Derivative (PID) function block combines all the necessary logic to perform proportional/integral/derivative control. The block supports mode control, signal scaling and limiting, feed forward control, override tracking, alarm limit detection, and signal status propagation.

### Integrator function block

Two permanent Integrator (INT) function blocks provides functionality for the transmitter totalizers. Any of seven internal totals or any of seven internal inventories can be selected and reset.

### Diagnostics and service

5700 transmitters automatically perform continuous self diagnostics. Using the Device transducer block, the user can perform on-line testing of the transmitter and sensor. Diagnostics are event driven and do not require polling for access.

PlantWeb<sup>®</sup> Field Diagnostic is supported. The diagnostic information is based on NAMUR NE 107 standard.

## Power supply

- Self switching AC/DC input, automatically recognizes supply voltage
- Complies with Low Voltage Directive 2014/35/EU per IEC 61010-1 Ed. 3.0 2010-06; Over voltage Category II, Pollution Degree 2
- For European installations, install a switch or circuit breaker that is suitably located and easily reached. Mark the switch or circuit breaker as the disconnecting device for the transmitter, in compliance with the Low Voltage Directive 2014/35/EU.

Type	Value
AC power	<ul style="list-style-type: none"> <li>▪ 85 to 240 VAC, 50/60 Hz</li> <li>▪ 6 watts typical, 11 watts maximum</li> </ul>
DC power	<ul style="list-style-type: none"> <li>▪ 18 to 100 VDC</li> <li>▪ 6 watts typical, 11 watts maximum</li> <li>▪ Size the length and diameter of power conductors to provide 18VDC minimum at the power terminals at a load current of 0.7A</li> </ul>
Fuse	1.5A Slow Blow (UL 248-14)

## Environmental limits

### Ambient temperature limits

Type	Temperature
Operating	-40 °F (-40.0 °C) to 149 °F (65.0 °C)
Storage	-40 °F (-40.0 °C) to 185 °F (85.0 °C)

#### Note

The display can lose visibility below -22 °F (-30.0 °C).

### Vibration limits

Meets IEC 60068-2-6, endurance sweep, 5 to 2000 Hz up to 1.0 g.

### Humidity limits

The humidity limits are 5 to 95% relative humidity, non-condensing at 140 °F (60.0 °C).

## Environmental effects

### EMI effects

Complies with:

- EMC directive 2014/30/EU
- NAMUR NE-21 (09.05.2012)

### Ambient temperature effect

Ambient temperature effect on mA Outputs shall not exceed +/-0.005% of span per degree C.

# Hazardous area classifications

## CSA and CSA-US

- Ambient temperature is limited to -40 °F (-40.0 °C) to 149 °F (65.0 °C) for CSA compliance.
- Class I, Div. 1, Groups C and D. Class II, Div. 1, Groups E, F, and G explosion proof (when installed with approved conduit seals). Otherwise, Class I, Div. 2, Groups A, B, C, and D.
- Provides nonincendive sensor outputs for use in Class I, Div. 2, Groups A, B, C, and D; or intrinsically safe sensor outputs for use in Class I, Div. 1, Groups C and D or Class II, Div. 1, Groups E, F, and G.

Code	Description
AA	Class I, Div. 1, Groups C and D. Class I, Div. 2, groups A,B,C,D Class II, Div. 1, Groups E, F, and G explosion proof (when installed with approved conduit seals).
2A	Class I, Div. 2, Groups A, B, C, and D.

## IECEX

Ambient temperature range is -40 °F (-40.0 °C) to 149 °F (65.0 °C) for IECEx compliance.

### Configurable I/O — ordering code A

**Note**

For EA and 3A approval codes, the marking will change when installed with Smart Wireless 775 THUM.

Classification	Approval code	Approval	
Flameproof	IA	Standard display	Ex db [ib] IIB+H <sub>2</sub> T6 Gb
		No display or IIC display	Ex db [ib] IIC T6 Gb
		Dust marking	Ex tb [ib] IIIC T75 °C Db IP66/IP67
Increased safety	EA	Standard display	Ex db eb [ib] IIB+ H <sub>2</sub> T6 Gb
		No display or IIC display	Ex db eb [ib] IIC T6 Gb
		Dust marking	Ex tb [ib] IIIC T75 °C Db IP66/IP67
Non sparking with an integral transmitter on the sensor	3A	Standard display	Ex nA nC IIB+H <sub>2</sub> T5Gc
		No display or IIC display	Ex nA nC IIC T5 Gc
		Dust marking	Ex tc IIIC T75 °C Dc IP66/IP67
Non sparking with a remote transmitter on the sensor	3A	Standard display	Ex nA nC [ib Gb] IIB+H <sub>2</sub> T5 Gc
		No display or IIC display	Ex nA nC [ib Gb] IIC T5 Gc
		Dust marking	Ex tc [ib Db] IIIC T75 °C Dc IP66/IP67

### Ethernet — ordering code C

Classification	Approval code	Approval	
Flameproof	IA	Standard display	Ex db [ib] IIB+H <sub>2</sub> T6 Gb
		No display or IIC display	Ex db [ib] IIC T6 Gb
		Dust marking	Ex tb [ib] IIIC T75 °C Db IP66/IP67

Classification	Approval code	Approval	
Non sparking with an integral transmitter on the sensor	3A	Standard display	Ex nA nC IIB+H <sub>2</sub> T4 Gc
		No display or IIC display	Ex nA nC IIC T4 Gc
		Dust marking	Ex tc IIIC T75 °C Dc IP66/IP67
Non sparking with a remote transmitter on the sensor	3A	Standard display	Ex nA nC [ib Gb] IIB+H <sub>2</sub> T4 Gc
		No display or IIC display	Ex nA nC [ibGb] IIC T4 Gc
		Dust marking	Ex tc [ib Db] IIIC T75 °C Dc IP66/IP67

### FOUNDATION Fieldbus — ordering code N

Classification	Approval code	Approval	
Flameproof	IA	Standard display	Ex db [ib] IIB+H <sub>2</sub> T6 Gb
		No display or IIC display	Ex db [ib] IIC T6 Gb
		Dust marking	Ex tb [ib] IIIC T75 °C Db IP66/IP67
Increased safety	EA	Standard display	Ex db eb [ib] IIB+ H <sub>2</sub> T6 Gb
		No display or IIC display	Ex db eb [ib] IICT6 Gb
		Dust marking	Ex tb [ib] IIIC T75 °C Db IP66/IP67
Non sparking with an integral transmitter on the sensor	3A	Standard display	Ex nA IIB+H <sub>2</sub> T4 Gc
		No display or IIC display	Ex nA IIC T4 Gc
		Dust marking	Ex tc IIIC T75 °C Dc IP66/IP67
Non sparking with a remote transmitter on the sensor	3A	Standard display	Ex nA [ib Gb] IIB + H <sub>2</sub> T4 Gc
		No display or IIC display	Ex nA [ib Gb] IIC T4 Gc
		Dust marking	Ex tc [ib Db] IIIC T75 °C Dc IP66/IP67

### FOUNDATION Fieldbus FISCO — ordering code E

FISCO covers Ex ia, ib, and ic.

Classification	Approval code	Approval	
Flameproof	IA	Standard display	Ex db [ia Ga] [ib] IIB+H <sub>2</sub> T6 Gb
		No display or IIC display	Ex db [ia Ga][ib] IIC T6 Gb
		Dust marking	Ex tb [ia Da] [ib] IIIC T75 °C Db IP66/IP67
Increased safety	EA	Standard display	Ex db eb [ia Ga][ib] IIB+H <sub>2</sub> T6 Gb
		No display or IIC display	Ex db eb [ia Ga] [ib] IICT6 Gb
		Dust marking	Ex tb [ia Da] [ib] IIIC T75 °C Db IP66/IP67
Non sparking with an integral transmitter on the sensor	3A	Standard display	Ex nA [ic] IIB+H <sub>2</sub> T4 Gc
		No display or IIC display	Ex nA [ic] IIC T4 Gc
		Dust marking	Ex tc IIIC T75 °C Dc IP66/IP67
Non sparking with a remote transmitter on the sensor	3A	Standard display	Ex nA [ic] [ib Gb] IIB+H <sub>2</sub> T4 Gc
		No display or IIC display	Ex nA [ic] [ib Gb] IIC T4 Gc

Classification	Approval code	Approval	
		Dust marking	Ex tc [ib Db] IIIC T75 °C Dc IP66/IP67

**Intrinsically safe outputs — ordering code D**

**Note**

For EA and 3A approval codes, the marking will change when installed with Smart Wireless 775 THUM.

Classification	Approval code	Approval	
Flameproof	IA	Standard display	Ex db [ib] [ia] IIB+H <sub>2</sub> T6 Gb
		No display or IIC display	Ex db [ib] [ia] IIC T6 Gb
		Dust marking	Ex tb [ib] [ia] IIIC T75 °C Db IP66/IP67
Increased safety	EA	Standard display	Ex db eb [ib] [ia] IIB+ H <sub>2</sub> T6 Gb
		No display or IIC display	Ex db eb [ib] [ia] IICT6 Gb
		Dust marking	Ex tb [ib] [ia] IIIC T75 °C Db IP66/IP67

**IECEx mounting options for all models**

Code	Description
IA all mounting options	Used in IECEx EPL Gb/Db Zone 1/21 with flameproof (Ex db) terminal compartment with [ib] output for sensors installed in Zone 1/21
EA all mounting options	Used in IECEx EPL Gb/Db Zone 1/21 with increased safety (Ex eb) terminal compartment and flame proof (Ex db) electronic compartment with [ib] output for sensors installed in Zone 1/21
3A mounting option I Not available for a 5700 with intrinsically safe output configurations	Used in IECEx EPL Gc/Dc Zone 2/22, non sparking
3A mounting option R and C Not available for a 5700 with intrinsically safe output configurations	Used in IECEx EPL Gc/Dc Zone 2/22, non sparking with [ib Gb/Db] output for sensors installed in Zone 1/21

**ATEX**

Ambient temperature range is -40 °F (-40.0 °C) to 149 °F (65.0 °C) for ATEX compliance.

**Configurable I/O — ordering code A**

**Note**

For ZA and VA approval codes, the marking will change when installed with Smart Wireless 775 THUM.

Classification	Approval code	Approval	
Flameproof	FA	Standard display	CE <sup>2460</sup> Ex II 2 G/D Ex db [ib] IIB+H <sub>2</sub> T6 Gb
		No display or IIC display	Ex db [ib] IIC T6 Gb





Classification	Approval code	Approval	
		Dust marking	Ex tb [ib] IIIC T75 °C Db IP66/IP67
Increased safety	ZA	Standard display	CE <sup>2460</sup> Ex II 2 G/D Ex db eb [ib] IIB+H <sub>2</sub> T6 Gb
		No display or IIC display	Ex db eb [ib] IIC T6 Gb
		Dust marking	Ex tb [ib] IIIC T75 °C Db IP66/IP67
Non sparking with an integral transmitter on the sensor	VA	Standard display	CE <sup>2460</sup> Ex II 3 G/D Ex nA nC IIB+H <sub>2</sub> T5 Gc
		No display or IIC display	Ex nA nC IIC T5 Gc
		Dust marking	Ex tc IIIC T75 °C Dc IP66/IP67
Non sparking with a remote transmitter on the sensor	VA	Standard display	CE <sup>2460</sup> Ex II 3(2) G/D Ex nA nC [ib Gb] IIB+H <sub>2</sub> T5 Gc
		No display or IIC display	Ex nA nC [ib Gb] IIC T5 Gc
		Dust marking	Ex tc [ib Db] IIIC T75 °C Dc IP66/IP67

### Ethernet — ordering code C

Classification	Approval code	Approval	
Flameproof	FA	Standard display	CE <sup>2460</sup> Ex II 2 G/D Ex db [ib] IIB+H <sub>2</sub> T6 Gb
		No display or IIC display	Ex db [ib] IIC T6 Gb
		Dust marking	Ex tb [ib] IIIC T75 °C Db IP66/IP67
Non sparking with an integral transmitter on the sensor	VA	Standard display	CE <sup>2460</sup> Ex Ex nA nC IIB+H <sub>2</sub> T4 Gc
		No display or IIC display	Ex nA nC IIC T4 Gc
		Dust marking	Ex tc IIIC T75 °C Dc IP66/IP67
Non sparking with a remote transmitter on the sensor	VA	Standard display	CE <sup>2460</sup> Ex Ex nA nC [ib Gb] IIB+H <sub>2</sub> T4 Gc
		No display or IIC display	Ex nA nC [ib Gb] IIC T4 Gc
		Dust marking	Ex tc [ib Db] IIIC T75 °C Dc IP66/IP67





### FOUNDATION Fieldbus — ordering code N

Classification	Approval code	Approval	
Flameproof	FA	Standard display	CE <sup>2460</sup> Ex II 2G/D Ex db [ib] IIB+H <sub>2</sub> T6 Gb

Classification	Approval code	Approval	
		No display or IIC display	Ex db [ib] IIC T6 Gb
		Dust marking	Ex tb [ib] IIIC T75 °C Db IP66/IP67
		Standard display	 II 2 G/D Ex db eb [ib] IIB+H <sub>2</sub> T6 Gb
Increased safety	ZA	No display or IIC display	Ex db eb [ib] IIC T6 Gb
		Dust marking	Ex tb [ib] IIIC T75 °C Db IP66/IP67
		Standard display	 Ex nA IIB+H <sub>2</sub> T4 Gc
Non sparking with an integral transmitter on the sensor	VA	No display or IIC display	Ex nA IIC T4 Gc
		Dust marking	Ex tc IIIC T75 °C Dc IP66/IP67
		Standard display	 Ex nA [ib Gb] IIB+H <sub>2</sub> T4 Gc
Non sparking with a remote transmitter on the sensor	VA	No display or IIC display	Ex nA [ib Gb] IIC T4 Gc
		Dust marking	Ex tc [ib Db] IIIC T75 °C Dc IP66/IP67
		Standard display	 Ex nA [ib Gb] IIB+H <sub>2</sub> T4 Gc

**FOUNDATION Fieldbus FISCO — ordering code E**

FISCO covers Ex ia, ib, and ic.

Classification	Approval code	Approval	
Flameproof	FA	Standard display	 II (1) 2 G/D Ex db [ia Ga] [ib] IIB+H <sub>2</sub> T6 Gb
		No display or IIC display	Ex db [ia Ga] [ib] IIC T6 Gb
		Dust marking	Ex tb [ia Da] [ib] IIIC T75 °C Db IP66/IP67
Increased safety	ZA	Standard display	 II (1) 2 G/D Ex db eb [ia Ga] [ib] IIB+H <sub>2</sub> T6 Gb
		No display or IIC display	Ex db eb [ia Ga] [ib] IIC T6 Gb
		Dust marking	Ex tb [ia Da] [ib] IIIC T75 °C Db IP66/IP67
Non sparking with an integral transmitter on the sensor	VA	Standard display	 Ex nA [ic] IIB+H <sub>2</sub> T4 Gc
		No display or IIC display	Ex nA [ic] IIC T4 Gc
		Dust marking	Ex tc IIIC T75 °C Dc IP66/IP67
Non sparking with a remote transmitter on the sensor	VA	Standard display	 Ex nA [ic] [ib Gb] IIB+H <sub>2</sub> T4 Gc
		No display or IIC display	Ex nA [ic] [ib Gb] IIC T4 Gc
		Dust marking	Ex tc [ib Db] IIIC T75 °C Dc IP66/IP67

**Intrinsically safe outputs — ordering code D**

**Note**

For ZA approval codes, the marking will change when installed with Smart Wireless 775 THUM.

Classification	Approval code	Approval	
Flameproof	FA	Standard display	CE <sup>2010</sup> Ex II 2 G/D Ex db [ib] [ia] IIB+H <sub>2</sub> T6 Gb
		No display or IIC display	Ex db [ib] [ia] IIC T6 Gb
		Dust marking	Ex tb [ib] [ia] IIIC T75 °C Db IP66/IP67
Increased safety	ZA	Standard display	CE <sup>2010</sup> Ex II 2 G/D Ex db eb [ib] [ia] IIB+H <sub>2</sub> T6 Gb
		No display or IIC display	Ex db eb [ib] [ia] IIC T6 Gb
		Dust marking	Ex tb [ib] [ia] IIIC T75 °C Db IP66/IP67

**ATEX mounting codes for all models**

Code	Description
FA (all mounting options)	Used in ATEX II 2 G/D Zone 1/21 with flameproof (Ex db) terminal compartment with [ib] output for sensors installed in Zone 1/21.
ZA (all mounting options)	Used in ATEX II 2 G/D Zone 1/21 with increased safety (Ex eb) terminal compartment and flame proof (Ex db) electronic compartment with [ib] output for sensors installed in Zone 1/21
VA mounting option I Not available for a 5700 with intrinsically safe output configurations	Used in ATEX II 3 G/D Zone 2/22 with non-sparking.
VA mounting option R and C Not available for a 5700 with intrinsically safe output configurations	Used in ATEX II (2) 3 G/D Zone 2/22, non-sparking with [ib Gb/Db] output for sensors installed in Zone 1/21.

**Environmental compliance**

RoHS and WEEE compliance

	<p>The battery in the 5700 transmitter cannot be serviced or replaced by users. In compliance with RoHS (Restriction of Hazardous Substances) and WEEE (Waste Electrical and Electronic Equipment), Micro Motion provides a service for battery replacement and disposal.</p> <p>The 5700 transmitter complies with RoHS Directive 2011/65/EU.</p>
---	--



Ingress protection	<p>5700 transmitters contain the following ingress protection for specific transmitters:</p> <ul style="list-style-type: none"> <li>■ All 5700 transmitters have NEMA 4X protection.</li> <li>■ 5700I transmitters have IP66/IP67 protection.</li> <li>■ 5700C and 5700R transmitters have IP66/IP67/IP69(K)<sup>(1)</sup> protection.</li> </ul>
--------------------	---

(1) The protection is IP69K when using standard NEN-ISO 20653:2013 and IP69 when using standard IEC/EN 60529.

## Physical specifications

For transmitters integrally mounted to a sensor, you may need to add the weight of the transmitter to the sensor. Refer to the sensor product data sheet.

### Materials of construction

Where 4-wire cable is required, use Micro Motion 4-wire cable, depending on the specific model number ordered, 10 ft (3.05 m) of shielded PVC cable (4-wire or 9-wire) will be included (see ordering information for details). For longer cable lengths, contact customer support.

Specification	Value		
Housing	<ul style="list-style-type: none"> <li>■ Polyurethane-painted cast aluminum</li> </ul>		
Weight	<ul style="list-style-type: none"> <li>■ Painted aluminum, 4-wire and 9-wire remote: 16 lb (7.3 kg)</li> <li>■ Painted aluminum integral: 11 lb (5.0 kg)</li> </ul>		
Terminal compartments	<ul style="list-style-type: none"> <li>■ Output terminals are physically separated from the power and service-port terminals</li> </ul>		
Cable gland entrances	<ul style="list-style-type: none"> <li>■ 4-wire remote: Either 5 M20 conduit entries or 5.5 in (140 mm)-14 in (356 mm) NPT</li> <li>■ 9-wire remote: 1.75 in (44.4 mm) - 14 in (356 mm) NPT female conduit port for sensor cable and for power and I/O for one of the following entries:                             <ul style="list-style-type: none"> <li>— 4 M20 conduit entries</li> <li>— 4.5 in (114 mm) NPT conduit entries</li> </ul> </li> </ul>		
Optional M12 Connections (Ethernet version only)	<ul style="list-style-type: none"> <li>■ Pre-installed M12 quick connections available as an option</li> <li>■ Option of (2) pre-installed for Ethernet connections and an option for additional (2) connections for power and configurable output</li> <li>■ Suitable for Class 1, Division 2 approval only</li> </ul>		
Mounting	<ul style="list-style-type: none"> <li>■ Integral or remote mounting options</li> <li>■ May be remotely connected to any 4-wire or 9-wire Micro Motion sensor</li> <li>■ Remote-mount transmitters include a 304L and a 316L stainless steel mounting bracket, and the hardware for installing the transmitter on the mounting bracket</li> <li>■ For remote 4-wire or 9-wire mounts, the transmitter can be rotated 360 degrees with respect to customer wall or pipe in 90-degree increments</li> <li>■ For integral mount, the transmitter can be rotated with respect to the sensor in 45-degree increments</li> </ul>		
Maximum cable lengths between sensor and	Cable type	Wire gauge	Maximum length

Specification	Value			
transmitter	Micro Motion 9-wire	Not applicable	1,000 ft (305 m) <sup>(1)</sup>	
	Micro Motion 4-wire	Not applicable	1,000 ft (305 m)	
	User-supplied 4-wire	VDC 22 AWG (0.326 mm <sup>2</sup> )		300 ft (91 m)
		VDC 20 AWG (0.518 mm <sup>2</sup> )		500 ft (152 m)
		VDC 18 AWG (0.823 mm <sup>2</sup> )		1,000 ft (305 m)
	RS-485 22 AWG (0.326 mm <sup>2</sup> ) or larger		1,000 ft (305 m)	
	For the cable sizing formula, see the appropriate Micro Motion 5700 installation manual.			
Standard interface/display	<ul style="list-style-type: none"> <li>■ Graphical backlit display with 4-button optical controls and flowmeter-status LED</li> <li>■ Depending on purchase option, transmitter housing cover has either a non-glass lens or tempered glass lens option</li> <li>■ To facilitate various mounting orientations, the display can be rotated on transmitter, 360 degrees, in 90-degree increments</li> <li>■ Display supports English, German, French, Spanish, Portuguese, Russian, Chinese, and Japanese</li> </ul>			
Display functions	<ul style="list-style-type: none"> <li>■ Complete operation and configuration through the display, no service tool required</li> <li>■ View process variables</li> <li>■ Start, stop, and reset totalizers</li> <li>■ View and acknowledge alarms</li> <li>■ View the Smart Meter Verification initiation and results from the display without interrupting process measurement</li> <li>■ Set the flowmeter to zero, simulate outputs, change measurement units, configure outputs, and set RS-485 communications options</li> <li>■ View a three-color LED status light on display panel that indicates flowmeter conditions at a glance</li> </ul>			

(1) For Smart Meter Verification, the limit is 66 ft (20.12 m)

## Dimensions

### Remote mount transmitter

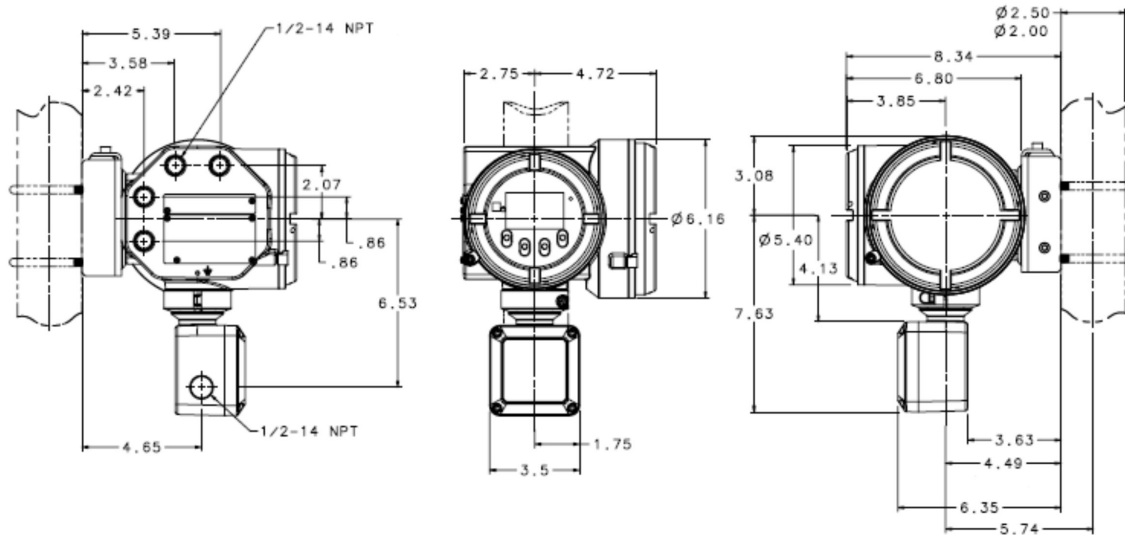

### Integral mount transmitter

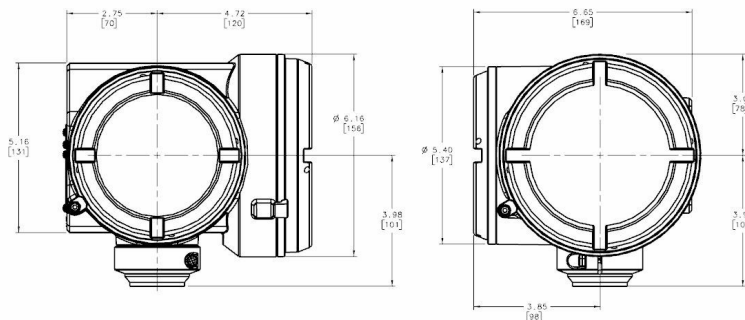

## Ordering information

Model	Product description
5700	Micro Motion Coriolis field mount transmitter

Code	Mounting options
I	Integral mount transmitter (polyurethane-painted aluminum housing)
R	4-wire remote mount transmitter (polyurethane-painted aluminum housing), bracket for wall or pipe mounting, and hardware for 2 in (51 mm) pipe mount, includes 10 ft (3 m) 4-wire shielded PVC cable
C	9-wire remote transmitter with integrated core processor (polyurethane-painted aluminum housing), bracket for wall or pipe mounting, and hardware for 2 in (51 mm) pipe mount, includes 10 ft (3 m) 9-wire CFEPs cable

Code	Power options
1	18 to 100 VDC or 85 to 240 VAC; self switching

Code	Display options
Available with all approval codes	
2	Backlit graphic display for CSA, UL, and IIB + H2 ATEX, and IECEx ratings
3	No display
Available with FA, IA, and R2 approval codes	
5	Backlit graphic display for IIC ATEX, IECEx, and NEPSI rating
Available with MA approval code	
7	Non-glass backlit graphic display

Code	Output board options
A	Configurable outputs
C <sup>(1)(2)(3)(4)</sup>	Ethernet outputs, select EtherNet/IP, Modbus TCP, or PROFINET in channel assignment section
E <sup>(1)(3)</sup>	Intrinsically safe FOUNDATION Fieldbus H1 outputs
N <sup>(1)(3)</sup>	Non-intrinsically safe FOUNDATION Fieldbus H1 outputs
D <sup>(5)</sup>	Intrinsically safe outputs

- (1) Not available with Certificate Option SI.  
(2) Not available with approval options ZA, EA, or R1.  
(3) Not available with Certificate Option R2.  
(4) Not available with approval codes ZA or EA.  
(5) Not available with approval options PA, KA, VA, 3A, 4A, R1, R2 or R3.

Code	Conduit connection options
B	0.5 in (13 mm) NPT – no gland
C <sup>(1)</sup>	0.5 in (13 mm) NPT with brass/nickel cable gland
D <sup>(1)</sup>	0.5 in (13 mm) NPT with stainless steel cable gland
E	M20 - no gland
F <sup>(1)</sup>	M20 with brass/nickel cable gland
G <sup>(1)</sup>	M20 with stainless steel cable gland

- (1) Not approved in Class 1 Division 1 installations.

Code	Approval options
MA	Micro Motion Standard (no approval)
AA	CSA (US and Canada): Class I, Division 1, Groups C and D
ZA	ATEX: II 2G, Ex db eb, Zone 1 and II 2D Ex tb, Zone 21
FA	ATEX: II 2G, Ex d, Zone 1 and II 2D Ex tb, Zone 21
IA	IECEx: EPL Gb, Ex d, Zone 1 and EPL Db Ex tb, Zone 21
EA	IECEx: EPL Gb, Ex db eb, Zone 1 and EPL Db Ex tb, Zone 21

Code	Approval options
2A	CSA (US and Canada): Class I, Division 2, Groups A, B, C, D; sensor connections will be intrinsically safe without additional barrier
VA <sup>(1)</sup>	ATEX: II 3G, Ex nA nC, Zone 2 and II 3D Ex tc Zone 22
3A <sup>(1)</sup>	IECEX: EPL Gc, Ex nA nC, Zone 2 and EPL Dc, Ex tc, Zone 22
R1	EAC: Ex de, Zone 1
R2	EAC: Ex d, Zone 1
R3	EAC: nA nC, Zone 2

(1) Sensor connections will be Intrinsically Safe without additional barrier.

Code	Transmitter option 1
Z	Standard product

Code	Transmitter option 2
Z	Standard product

Code	Factory options
Z	Standard product
X	ETO product

Channel	Code	Output channel assignment
A	Available with output board code A	
	Z	Channel Off
	A	Channel On; mA Output with HART
	Available with output hardware board code C	
	C	EtherNet/IP output 1
	D	Modbus TCP output 1
	H	PROFINET output 1
	Available with output hardware board code E, N	
	F	FOUNDATION Fieldbus output
	Available with D output hardware board	
	Z	Channel Off
B	Channel On; Intrinsically safe mA Output with HART	
B	Available with output hardware board code A	
	Z	Channel Off
	A	Channel On; Configurable to mA Output, Frequency Output, and Discrete Output
	Available with output hardware board code C (selection must match Channel A)	
	C	EtherNet/IP output 2

Channel	Code	Output channel assignment
	D	Modbus TCP output 2
	H	PROFINET output 2
	Available with output hardware board code E, N	
	E	Channel On; mA Output
	Available with D output hardware board	
	Z	Channel Off
	B	Channel On; Intrinsically safe mA Output
C	Available with output hardware board code A	
	Z	Channel Off
	A	Channel On; Configurable to mA Output, Frequency Output, Discrete Output, and Discrete Input
	Available with output hardware board code C	
	C	Configurable to mA Output, Frequency Output, Discrete Output, and Discrete Input
	Available with output hardware board code E, N	
	E	Channel On; Configurable to Frequency Output, and Discrete Output
	Available with D output hardware board	
	Z	Channel Off
	B	Channel On; Intrinsically safe mA Output
D	Available with output hardware board code A	
	Z	Channel Off
	A	Channel On; Configurable to mA Input, Frequency Input, Frequency Output, Discrete Output, and Discrete Input
	Available with output hardware board code C	
	Z	Channel Off
	Available with output hardware board code E, N	
	Z	Channel Off
	Available with D output hardware board	
	Z	Channel Off
	B	Channel On; Intrinsically safe, configurable to mA Output, Frequency Output, Discrete Output
E	Available with output hardware board code A	
	Z	Channel Off
	A	On; RS-485 Modbus, RS-485 HART, and printing support
	Available with output hardware board code C, E, N, D	

Channel	Code	Output channel assignment
	Z	Channel Off
Code	Additional features (all optional)	
Instrument tagging		
TG	Instrument Tagging - customer information required (maximum 24 characters)	
	Meter verification	
MV <sup>(1)</sup>	Smart Meter Verification	
Weights & Measures approval Requires output board code A (or C for option NT only) and display code 2, 5 or 7 (select only one from this group)		
NT <sup>(2)</sup>	Weights & Measures custody transfer approval - NTEP	
OG <sup>(2)</sup>	Weights & Measures custody transfer approval - MID & OIML for gas	
OL <sup>(2)</sup>	Weights & Measures custody transfer approval - MID & OIML for liquid	
Enhanced measurement (select only one from this group)		
PS <sup>(2)</sup>	API referral software	
CM <sup>(2)</sup>	Concentration measurement software	
Additional software options (select any from this group)		
BS <sup>(2)(3)</sup>	Batching software package	
Advanced Phase Measurement (select any from this group)		
PG <sup>(4)</sup>	Advanced Phase Measurement Gas with Liquid	
PL <sup>(4)</sup>	Advanced Phase Measurement liquid with gas	
Net Oil Computer software (select one from this group)		
MA <sup>(4)(5)(6)</sup>	Manual Advanced Phase Measurement configuration	
MW <sup>(4)(7)(6)</sup>	Net Oil Computer software - multiple wells	
PO <sup>(4)</sup>	Net Oil Computer software - single well (PL option is highly recommended in conjunction with PO)	
Piecewise Linearization for Gas software		
PW <sup>(2)(3)</sup>	Piecewise Linearization for Gas software	
Additional certifications requires either:		
<ul style="list-style-type: none"> <li>■ Hardware output board option A with output Channel A and Channel D assignment of "A"</li> <li>■ Hardware output board option D with output Channel A assignment of "B"</li> </ul>		
SI	Safety certification of 4-20 mA outputs per IEC 61508	
Smart Wireless 775 THUM requires output code A or B option for Channel A (select only one from this group)		
PI <sup>(8)</sup>	Smart Wireless 775 THUM Ready - 775 ordered separately and assembled to the 5700	
NI	Smart Wireless 775 THUM Ready - 775 ordered separately and not assembled to the 5700	
Ethernet connectors, requires output hardware board code C (select only one from this group)		
CA <sup>(9)</sup>	(2) M12 Connectors for Ethernet ports	

Code	Additional features (all optional)
CB <sup>(9)</sup>	(2) M12 Connectors for Ethernet ports and (1) for Channel C and (1) for power

- (1) Available with all Mounting Options, but Mounting C is limited to 60 ft (18.29 m) of 9-wire cable and only available when purchased with new 9-wire sensor.
- (2) Not available with Certificate Option SI.
- (3) Not available with either Output Hardware Board E or N.
- (4) Not available with Add on options NT or SI.
- (5) Not available with Output Hardware Board Option E, N, or D.
- (6) Not available with Add on Option PL.
- (7) Available only with Output Hardware Board Option A.
- (8) Smart Wireless ready transmitter add on Option "PI" is only available with Approval Options 2A, VA, and 3A.
- (9) Only available with approval codes MA and 2A.









**Emerson Automation Solutions**

Worldwide Headquarters  
7070 Winchester Circle  
Boulder, Colorado USA 80301  
T: +1 800-522-6277  
T: +1 303-527-5200  
F: +1 303-530-8459  
Mexico: 52 55 5809 5300  
Argentina: 54 11 4837 7000  
Brazil: 55 15 3413 8147  
Chile: 56 2 2928 4800

**Emerson Automation Solutions**

Central Europe: +41 41 7686 111  
Eastern Europe: +41 41 7686 111  
Dubai: +971 4 811 8100  
Abu Dhabi: +971 2 697 2000  
Austria: +43 2236 607-0  
France: 0800 917 901  
Germany: +49 (0) 2173 3348 0  
Italy: 8008 77334  
The Netherlands: +31 318 495 555  
Belgium: +32 2 716 77 11  
Spain: 900 901 986  
U.K.: 0870 240 1978  
Russian/CIS: +7 495 981 9811

**Emerson Automation Solutions**

Australia: (61) 3 9721 0200  
China: (86) 21 2892 9000  
India: (91) 22 6662 0566  
Japan: (81) 3 5769 6803  
South Korea: (82) 31 8034 0000  
Singapore: (65) 6 363 7766

©2019 Micro Motion, Inc. All rights reserved.

The Emerson logo is a trademark and service mark of Emerson Electric Co. Micro Motion, ELITE, ProLink, MVD and MVD Direct Connect marks are marks of one of the Emerson Automation Solutions family of companies. All other marks are property of their respective owners.