

calys 1000/1200/1500

2 channels high accuracy multifunction calibrators



Instructions Manual

Instructions Manual NTA 47xxx-xxxA1

LIMIT OF GUARANTEE AND LIMIT OF RESPONSIBILITY

AOIP S.A.S guarantees the absence of faulty materials and the manufacture of this product under normal conditions of use and maintenance. The guarantee period is one year and takes effect on the date of delivery. Parts, repairs to the product and service are guaranteed for a period of 90 days. This guarantee only applies to the original purchaser or the end user if he is a client of a AOIP S.A.S approved distributor and does not cover fuses, interchangeable batteries/cells nor any product which, in the opinion of AOIP S.A.S, has been badly handled, modified, neglected or damaged by accident or subjected to abnormal conditions of use or handling. AOIP S.A.S guarantees that the software will function largely in accordance with its functional specifications for a period of 90 days and that it has been correctly recorded on non-defective media. AOIP S.A.S does not guarantee that the software contains no errors or that it will operate without interruption.

AOIP S.A.S approved distributors shall apply this guarantee to products sold to new clients it has not served, but are not authorised to offer a longer or different guarantee in the name of AOIP S.A.S. Guarantee support is offered if the product was purchased by an intermediary from an AOIP S.A.S approved point of sale or if the purchaser has paid the applicable international price. AOIP S.A.S reserves the right to invoice the purchaser for the costs of importing, repair or replacement parts if the product purchased in one country was sent to another country for repair.

The obligations under the guarantee of AOIP S.A.S are limited at the discretion of AOIP S.A.S, to reimbursement of the purchase price, or the free repair/replacement of a defective product returned within the period of the guarantee to an AOIP S.A.S approved service centre.

To claim for service under the guarantee, contact the nearest AOIP S.A.S agent or send the product, accompanied by a description of the problem, carriage and insurance paid (free on board destination), to the nearest AOIP S.A.S approved service centre. AOIP S.A.S declines any responsibility in the event of damage occurring during transportation. After repair under guarantee, the product will be returned to the purchaser, carriage paid (free on board destination). If AOIP S.A.S considers that the problem was caused by abusive treatment, modification, an accident or abnormal conditions of operation or handling, AOIP S.A.S will submit a quotation for the cost of repair and will only commence the repair after receiving authorisation. After repair, the product will be returned to the purchaser, carriage paid, and the costs of repair and transportation will be invoiced to him.

THIS GUARANTEE IS EXCLUSIVE AND REPLACES ANY OTHER GUARANTEES, EXPLICIT OR IMPLIED, INCLUDING, BUT NOT LIMITED TO, ANY IMPLIED GUARANTEE AS TO THE SUITABILITY OF THE PRODUCT TO BE SOLD OR APPLIED TO A PARTICULAR PURPOSE OR USE. AOIP S.A.S SHALL NOT BE HELD RESPONSIBLE FOR ANY PARTICULAR INDIRECT, ACCIDENTAL OR CONSEQUENTIAL DAMAGE, NOR ANY CORRUPTED OR LOST DATA, WHETHER AS A RESULT OF AN INFRACTION OF THE OBLIGATIONS OF THE GUARANTEE, OR ON A CONTRACTUAL, EXTRA-CONTRACTUAL OR OTHER BASIS.

Because some countries or states do not permit limitations to an implied condition of guarantee, or the exclusion or limitation of accidental or consequential damage, the limitations and exclusions of this guarantee may not apply to every purchaser. If any condition of this guarantee is considered invalid or inapplicable by a competent court, such a decision will in no way affect the validity or binding nature of any other condition.

Table of contents

CALYS 1000/1200/1500.....	1
A. PERFORMANCE.....	5
A.1 SPECIFICATIONS.....	6
A.2 CALYS 1000/1200 RANGES AND ACCURACIES.....	8
B. GENERAL FEATURES.....	10
B.1 INNOVATIVE DESIGN.....	10
B.2 FLEXIBILITY.....	10
B.3 KEYBOARD & DISPLAY.....	10
B.4.....	
B.5 FIRMWARE.....	10
B.6 SCALE FACTOR & SQUARE ROOT.....	10
B.7 COLD JUNCTION COMPENSATION.....	10
B.8 CALCULATED READINGS.....	10
B.9 TRANSMITTER SIMULATION AND CALIBRATION.....	10
B.10 FREQUENCY - COUNTS.....	11
B.11 PROGRAMMABLE SIGNAL CONVERTER.....	11
B.12 2,3,4 WIRE RESISTANCE THERMOMETER.....	11
B.13 REMOTE TEMPERATURE PROBE.....	11
B.14 GRAPHIC MODE.....	11
B.15 SIMULATION PROGRAMS.....	11
B.16 POWER SUPPLY.....	11
B.17 REPORT OF CALIBRATION.....	11
C. PHYSICAL DESCRIPTION.....	12
D. FUNCTIONAL DESCRIPTION.....	13
D.1 POWER SUPPLY.....	13
D.2 OPERATIVE KEYBOARD.....	13
D.3 INPUT CIRCUIT.....	15
D.4 MICROCONTROLLER.....	15
D.5 FIRMWARE.....	15
D.6 DIGITAL DISPLAY.....	15
D.7 DIGITAL TO ANALOG CONVERTER.....	16
D.8 EXTERNAL BATTERY CHARGER OR MAINS LINE OPERATION.....	16
D.9 DIGITAL INTERFACE.....	16
D.10 RESISTANCE AND RTD MEASUREMENTS.....	16
D.11 RESISTANCE AND RTD SIMULATION.....	17
D.12 THERMOCOUPLES INPUT/OUTPUT CIRCUIT.....	17
E. PRE-OPERATIONAL CHECK.....	18
E.1 UNPACKING.....	18
E.2 CASE.....	18
E.2.1 Portable cases.....	18
E.2.2 Panel mounting.....	18
E.2.3 Table top.....	18
F. POWER SUPPLY.....	19
F.1 POWER SUPPLY AND RECHARGEABLE BATTERY.....	19
F.1.1 Charging the battery.....	19
F.1.2 How to maximize the life span of the battery.....	19
F.2 LINE OPERATION.....	19
G. ELECTRICAL CONNECTIONS.....	20
G.1 WIRING PRACTICE.....	20
G.2 THERMOCOUPLE WIRES.....	20
G.3 REMOTE CONNECTIONS.....	21
G.3.1 External switch input.....	21
G.3.2 Rj remote.....	21
H. OPERATION & APPLICATIONS.....	22
H.1 POWER-ON.....	22
H.2 CONFIGURATION RESET.....	22
H.3 NEXT CALIBRATION DATE.....	22
H.4 DIGITAL DISPLAY ADJUSTMENTS.....	23
H.4.1 Display backlight.....	23
H.4.2 Autolamp mode.....	23
H.5 "HELP" KEY.....	24
H.6 CONFIGURATION REVIEW (STATUS).....	24
H.7 GENERAL CONFIGURATION SET-UP.....	26
H.8 SLOT DISPLAY SWAPPING.....	27
H.9 CHANNELS SCROLLING.....	27
H.10 DECIMAL POINT POSITION.....	26
H.11 AVERAGE MODE.....	28
H.12 AUTORANGE.....	28
H.13 ALARM FUNCTION.....	28
H.14 PARAMETER OR SENSOR SELECTION.....	29
H.15 SCALE FACTOR MODE SET-UP.....	29
H.16 TEMPERATURE PARAMETERS SELECTION.....	30
H.17 RJ FAST MODE SELECTION.....	31
H.18 RESISTANCE THERMOMETER SELECTION.....	31
H.19 IN-OUT DATA MEMORY.....	31
H.20 AUTOSCAN PROGRAM MODE.....	32
H.21 RAMP PROGRAM MODE.....	32
H.22 BARGRAPH FUNCTION.....	33
H.23 SWITCH TEST ROUTINE.....	33
H.24 OFFSET MODE SET-UP.....	35
H.25 FREQUENCY I/O.....	35
H.25.1 Frequency OUT.....	35
H.25.2 Frequency IN.....	35

H.26	TRANSMITTER SIMULATION	35
H.27	GRAPHIC OPERATIVE MODE	36
H.28	PULSE I/O.....	37
H.28.1	Pulse OUT	37
H.28.2	Pulse frequency measurement and counter mode.....	37
H.29	PERCENTAGE AND ERROR DISPLAY	38
I.	OPTIONS & ACCESSORIES	41
I.1	EXTERNAL PRINTER	41
I.1.1	General recommendation	41
I.1.2	Printer operations: General	41
I.1.3	Printer operation: Normal In-Out mode.....	41
I.2	DATA LOGGING FUNCTION.....	42
I.2.1	Printout of memory stored data	44
I.3	PM200 PRESSURE MODULE	45
J.	DIGITAL INTERFACE.....	46
J.1	DIGITAL OUTPUT WIRING PRACTICE.....	46
J.1.1	TTL to RS232 adaptor	46
J.2	COMMUNICATION PROTOCOL FROM CALYS TO A PC	47
J.2.1	Computer data request from Calys	47
J.2.2	Computer data setting from PC to Calys	54
K.	MAINTENANCE	57
K.1	FAULTY OPERATING CONDITIONS	57
K.2	PROTECTION FUSES	57
K.3	SAFETY RECOMMENDATIONS	58
K.4	STORAGE.....	58
K.5	EMC CONFORMITY	58

A. PERFORMANCE

Calys 1000/1200 and **Calys 1500** are two insulated channels multifunction calibrators. They are portable and developed to meet all the needs of instrumentation engineers and Quality managers, both in laboratory and in field work.

This units are accurate, rugged, compact and easy to use. They are the ideal solution to simulate and measure: Voltage, current, resistance, thermocouple, resistance thermometers, frequency and pulse.

Advanced flexibility and high performance has been achieved using 32 bit microprocessor and a fast A/D conversion technology. The calibrators memory, has stored inside all data for normalised IEC, DIN and JIS thermoelectric sensors for both IPTS68 and ITS90 International Temperature Scale. The microprocessor performs automatic linearization and cold junction compensation to assure high accuracy. It is possible to set the calibrator to execute menu-driven calibration procedure for your instruments in field work.

Both Channel 1 (Out) and Channel 2 (In) have the following operative mode capability:

- **millivolts**
- **volts**
- **milliamperes (active and passive loop)**
- **ohms**
- **temperature with thermocouples**
- **temperature with resistance thermometers**
- **frequency**
- **pulse**

Remote auxiliary inputs are available for

- **Relative humidity and temperature module**
- **Two internal sensor and built-in hand pump pressure module**

The ergonomic case design allows to use the calibrator in three different ways.

- **Portable** Two different leather cases, with cover and shoulder strap, are available on request for instrument alone or instrument, printer and accessories. These are extremely useful for a practical use since they allow to leave one hand free for instrument tuning.
- **Panel mounting** It requires a panel cutout of 242 x 88 mm. The instrument bezel flange butts against the front of the mounting plate; two lateral mounting brackets fit over the instrument rear panel
- **Table top** The case is equipped with 2 pivot feet to change the vertical viewing angle when using the instrument on the top of a table.

EMC Conformity

The instrument case, made in shock-resistant injection moulded ABS + polycarbonate has an internal metal coating to fulfil the prevision of the directive 89/336/CEE Electromagnetic Compatibility.

HIGHLIGHTS

Calys 1000

- 32-bit microprocessor and flash memory for firmware upgrading through serial interface
- All normalized IEC, DIN, JIS thermocouples
- Pt, Ni, Cu resistance thermometers temperature measurement and active simulation mA, mV, V, Ω , frequency, pulse, counter
- IPTS 68 and ITS 90 selection directly through keyboard
- Current output mode directly on active or passive loops
- Bidirectional serial interface
- Portable, table top and panel mounting
- Communication bus for extension to pressure and other optional modules
- Optional dedicated external impact type printer
- Traceable Report of Calibration

Calys 1200

- As Calys 1000 with improved performance and accuracy (0.01% rdg)
- Non volatile memory with real-time clock
- Logging and direct real-time graph with movable cursor to read the required actual value

Calys 1500

- As Calys 1200 calibrator with improved accuracy (0.0035% of rdg)
- 7 digit display for improved resolution (up to 0.1 μ V) for mV and V I/O



A.1 Specifications

- IN/OUT parameters:
 - Signal mV, V, mA, Ω , K Ω , frequency, pulses
 - thermocouples J, K, T, R, S, B, N, C, E, U, L, F, G, D
 - resistance thermometers Pt100 IEC, OIML, USLAB, US, SAMA, JIS Pt200, 500, 1000, 1000 OIML, Ni100, Ni120, Cu10, Cu100
- Reference junction compensation:
 - internal automatic from -10 °C to +55 °C
 - external adjustable from -50 °C to +100 °C
 - remote with external Pt100 from -10°C to +100 °C
- Rj compensation drift:
 - $\pm 0.015^{\circ}\text{C}/^{\circ}\text{C}$ (from -10 °C to +55 °C)
- Rj compensation error:
 - internal : $\pm 0.15^{\circ}\text{C}$
 - remote : $\pm 0.3^{\circ}\text{C}$
- Common mode rejection:
 - >140 dB at ac operation
- Normal mode rejection:
 - >70 dB at 50 or 60 Hz
- Temperature stability:
 - Calys 1000 /200+:
 - for temperature exceeding the band +18°C to +28°C (from +64 °C to +84 °F)
 - full scale: $\pm 8 \text{ ppm}/^{\circ}\text{C}$

- zero: $\pm 0.2 \mu\text{V}/^\circ\text{C}$
 - Calys 1500 :
 - for temperature exceeding the band $+21^\circ\text{C}$ to $+25^\circ\text{C}$ (from $+70^\circ\text{C}$ to $+77^\circ\text{F}$)
 - full scale: $\pm 3 \text{ ppm}/^\circ\text{C}$
 - zero: $\pm 0.2 \mu\text{V}/^\circ\text{C}$
- Output impedance (emf output):
 - $< 0.5 \Omega$ with 0.5 mA maximum current
- Input impedance (mV, V and Tc ranges):
 - $> 10 \text{ M}\Omega$
- Input impedance (mA ranges):
 - $< 140 \Omega @ 1 \text{ mA}$
- Source resistance effects:
 - $\pm 1 \mu\text{V}$ error for 1000 ohms source resistance
- Rtd and Ω simulation excitation current:
 - Calys 1000 /200+: from 0.01 to 5 mA
 - Calys 1500 : from 0.01 to 2 mA
- Rtd and Ω measurement excitation current:
 - $\sim 0.4 \text{ mA} @ 400\Omega$
 - $\sim 0.04 \text{ mA} @ 4000\Omega$
- Rtd connection:
 - 2, 3, and 4 wires
- Rtd cable compensation:
 - up to 100Ω (each wire)
- Rtd cable compensation error (Pt100):
 - $\pm 0.005^\circ\text{C}/\Omega$ of total wire
- Maximum load resistance:
 - $1000 \Omega @ 20 \text{ mA}$
- Display:
 - graphic LCD 240 x 64 dots display with LED backlight device
- Measurement sampling time:
 - 250 ms
- Output noise (at 300 Hz):
 - $< 2 \mu\text{Vpp}$ for ranges up to 200 mV f.s.,
 - $< 10 \mu\text{Vpp}$ for ranges up to 2 V f.s.
 - $< 80 \mu\text{Vpp}$ for ranges up to 20 V f.s.
- Digital interface:
 - full bidirectional TTL (a RS232 adapter normal or insulated, is available as an option)
- Channel 1-Channel 2 insulation:
 - 50 Vdc
- Calculation functions:
 - hold, max, min, offset, average
- Selection $^\circ\text{C}/^\circ\text{F}/\text{K}$:
 - through the configuration procedure
- In/Out data memory:
 - 20 data with manual or automatic recall
- Logging mode:
 - > 1500 input data items (optional memory card for memory extension)
- Convert function:
 - displays the electrical equivalent of the engineering unit
- Scale factor:
 - 5 different setting with zero and span programmable within -399999 and $+999999$
- Square root:
 - in combination with scale factor
- Calibration:
 - self learning technique with automatic procedure
- Power supply:
 - external supply or rechargeable Ni-Cd battery
- Battery life:
 - 6h on Tc and mV input/output (backlight Off)
 - 3.5h with 20 mA simulation (backlight Off)
- Recharging time:
 - 5h at 90% and 6h at 99% with instrument switched off. The battery charging is active only with the instrument switched off.
- Battery charge indication:
 - bar graph on the LCD display
- Line operation:
 - 100 - 120 - 230 Vac with the external battery charger
- Line transformer insulation:
 - 2500 Vac
- Firmware release identification:

CALYS 1000/1200 PERFORMANCE CALYS 1500

- release code on the display
- Operating environment temperature range:
 - from -10 °C to +55 °C (from 14 °C to 131 °F)
- Storage temperature range:
 - from -30 °C to +60 °C (from -22 °C to 140 °F)
- Case:
 - Injection moulded ABS with internal metal coating
- Dimensions:
 - 264 x 96 x 172 mm (DIN size)
- Weights:
 - nett 4 Kg gross 5,5 Kg

A.2 Calys 1000/1200 ranges and accuracies

IN-OUT RANGES

Sensor or parameter	Total range	High accuracy range	Resolution	CALYS 1200		Calys 1000	
				Accuracy (% of reading)	Accuracy (% of reading)	Accuracy (% of reading)	Accuracy (% of reading)
Tc type J	-210 to 1200°C -350 to 2200°F	-190 to 1200°C -310 to 2192°F	0.1°C 0.1°F	±(0.01% +0.1°C) ±(0.01% +0.18°F)		± (0.02% +0.1 °C) ± (0.02% +0.18 °F)	
Tc type K	-270 to 1370°C 454 to 2500°F	-160 to 1260°C -256 to 2300°F	0.1°C 0.1°F	±(0.01% +0.1°C) ±(0.01% +0.18°F)		± (0.02% +0.1 °C) ± (0.02% +0.18 °F)	
Tc type T	-270 to 400°C -454 to 760°F	-130 to 400°C -238 to 752°F	0.01°C 0.1°F	±(0.01% +0.1°C) ±(0.01% +0.18°F)		± (0.02% +0.1 °C) ± (0.02% +0.18 °F)	
Tc type R	-50 to 1760°C -60 to 3200°F	150 to 1760°C 302 to 3200°F	0.1°C 0.1°F	±(0.01% +0.2°C) ±(0.01% +0.36°F)		± (0.02% +0.2 °C) ± (0.02% +0.36 °F)	
Tc type S	-50 to 1760°C -60 to 3200°F	170 to 1760°C 338 to 3200°F	0.1°C 0.1°F	±(0.01% +0.2°C) ±(0.01% +0.36°F)		± (0.02% +0.2 °C) ± (0.02% +0.36 °F)	
Tc type B	50 to 1820°C 140 to 3310°F	920 to 1820°C 1688 to 3308°F	0.1°C 0.1°F	±(0.01% +0.3°C) ±(0.01% +0.54°F)		± (0.02% +0.3 °C) ± (0.02% +0.54 °F)	
Tc type C	0 to 2300°C 32 to 4180°F	0 to 2000°C 32 to 3632°F	0.1°C 0.1°F	±(0.01% +0.2°C) ±(0.01% +0.36°F)		± (0.02% +0.2 °C) ± (0.02% +0.36 °F)	
Tc type G	0 to 2300°C 32 to 4180°F	190 to 2300°C 374 to 4172°F	0.1°C 0.1°F	±(0.01% +0.3°C) ±(0.01% +0.54°F)		± (0.02% +0.3 °C) ± (0.02% +0.54 °F)	
Tc type D	0 to 2300°C 32 to 4180°F	0 to 2130°C 32 to 3866°F	0.1°C 0.1°F	±(0.01% +0.3°C) ±(0.01% +0.54°F)		± (0.02% +0.3 °C) ± (0.02% +0.54 °F)	
Tc type U	-200 to 400°C -330 to 760°F	-160 to 400°C -256 to 752°F	0.1°C 0.1°F	±(0.01% +0.1°C) ±(0.01% +0.18°F)		± (0.02% +0.1 °C) ± (0.02% +0.18 °F)	
Tc type L	-200 to 760°C -330 to 1400°F	-200 to 760°C -328 to 1400°F	0.1°C 0.1°F	±(0.01% +0.1°C) ±(0.01% +0.18°F)		± (0.02% +0.1 °C) ± (0.02% +0.18 °F)	
Tc type N	-270 to 1300°C -450 to 2380°F	0 to 1300°C 32 to 2372°F	0.1°C 0.1°F	±(0.01% +0.1°C) ±(0.01% +0.18°F)		± (0.02% +0.1 °C) ± (0.02% +0.18 °F)	
Tc type E	-270 to 1000°C -454 to 1840°F	-200 to 1000°C -328 to 1832°F	0.1°C 0.1°F	±(0.01% +0.1°C) ±(0.01% +0.18°F)		± (0.02% +0.1 °C) ± (0.02% +0.18 °F)	
Tc type F	0 to 1400°C 32 to 2560°F	0 to 1400°C 32 to 2552°F	0.1°C 0.1°F	±(0.01% +0.1°C) ±(0.01% +0.18°F)		± (0.02% +0.1 °C) ± (0.02% +0.18 °F)	
QI100 IEC	-200 to 850°C	-200 to 850°C	0.01°C	±(0.01% +0.05°C)		± (0.02% +0.05 °C)	
OI1ML, 3926	-330 to 1570°F	-328 to 1562 °F	0.1°F	±(0.01% +0.09°F)		± (0.02% +0.09 °F)	
Pt100	-200 to 650°C	-200 to 650°C	0.01°C	±(0.01% +0.05°C)		± (0.02% +0.05 °C)	
a 3902	-330 to 1210°F	-328 to 1210°F	0.1°F	±(0.01% +0.09°F)		± (0.02% +0.09 °F)	
Pt100 JIS	-200 to 600°C	-200 to 600°C	0.01°C	±(0.01% +0.05°C)		± (0.02% +0.05 °C)	
SAMA	-330 to 1120°F	-328 to 1112°F	0.1°F	±(0.01% +0.09°F)		± (0.02% +0.09 °F)	
Pt 200	-200 to 850°C -330 to 1570°F	-200 to 850°C -328 to 1562°F	0.1°C 0.1°F	±(0.01% +0.15°C) ±(0.01% +0.27°F)		± (0.02% +0.15 °C) ± (0.02% +0.27 °F)	
Pt 500	-200 to 850°C -330 to 1570°F	-200 to 530°C -328 to 986°F	0.1°C 0.1°F	±(0.01% +0.1°C) ±(0.01% +0.18°F)		± (0.02% +0.1 °C) ± (0.02% +0.18 °F)	
Pt1000 IEC	-200 to 850°C	-200 to 850°C	0.01°C	±(0.01% +0.1°C)		± (0.02% +0.1 °C)	
OI1ML	-330 to 1570°F	-328 to 1562°F	0.1°F	±(0.01% +0.18°F)		± (0.02% +0.18 °F)	
CU10	-70 to 150°C -100 to 310°F	-70 to 150°C -94 to 302°F	0.1°C 0.1°F	±(0.01% +0.4°C) ±(0.01% +0.72°F)		± (0.02% +0.4 °C) ± (0.02% +0.72 °F)	
CU100	-180 to 150°C -300 to 310°F	-180 to 150°C -292 to 302°F	0.1°C 0.1°F	±(0.01% +0.05°C) ±(0.01% +0.09°F)		± (0.02% +0.05 °C) ± (0.02% +0.09 °F)	
Ni100	-60 to 180°C -80 to 360°F	-60 to 180°C -76 to 356°F	0.1°C 0.1°F	±(0.01% +0.05°C) ±(0.01% +0.09°F)		± (0.02% +0.05 °C) ± (0.02% +0.09 °F)	
Ni120	0 to 150°C 32 to 310°F	0 to 150°C 32 to 302°F	0.1°C 0.1°F	±(0.01% +0.05°C) ±(0.01% +0.09°F)		± (0.02% +0.05 °C) ± (0.02% +0.09 °F)	
mV		-20 to +200mV	1µV	±(0.01% +2µV)		± (0.02% +2 µV)	
mV		-0.2 to +2 V	10 µV	±(0.01% +10 µV)		± (0.02% +10 µV)	
V		-2 to +20 V	0.1mV	±(0.01% +0.08mV)		± (0.02% +0.08 mV)	
mA (In)		-5 to +50mA	0.1µA	±(0.01% +0.4µA)		± (0.02% +0.4 µA)	
mA (Out)		0 to +50mA	0.1µA	±(0.01% +0.4µA)		± (0.02% +0.4 µA)	
Ω IN		0 to 500Ω	1mΩ	±(0.01% +12mΩ)		± (0.02% +12 mΩ)	
		0 to 5000 Ω	0.01Ω	±(0.01% +120mΩ)		± (0.02% +120 mΩ)	
Ω OUT		0 to 500 Ω	1 mΩ	±(0.01% +20mΩ)		± (0.02% +20 mΩ)	
		0 to 5000 Ω	0.01Ω	±(0.01% +200mΩ)		± (0.02% +200 mΩ)	
Frequency		1 to 200 Hz	0.001 Hz		±(0.005% +0.001 Hz)		
		1 to 2000 Hz	0.01		±(0.005% +0.001 Hz)		
		1 to 20000 Hz	0.1 Hz		±(0.005% +0.001 Hz)		
Pulse counter		0 to 10 ⁵ counts	1 count		infinie		
Pulse (Out)		0 to 6000 pulse/min	1 pulse/min		1 pulse/min		
		0 to 36000 pulse/h	1 pulse/h		1 pulse/min		

Note:

- The relative accuracies shown above are stated for 360 days and the operative conditions are from +18°C to +28°C
- Typical 90 days relative accuracy can be estimated by dividing the "% of reading" specifications by 1.6.
- Typical 2 years relative accuracy can be estimated by multiplying the "% of reading" specifications by 1.4.
- All input ranges: additional error ±1 digit.

CALYS 1500

Sensor or parameter	Total range	High accuracy range	Resolution	Accuracy (% of reading)
Tc type J	-210 to 1200°C -350 to 2200°F	-190 to 1200°C -310 to 2192°F	0.01°C 0.1°F	±(0.005%+0.1°C) ±(0.005%+0.18F)
Tc type K	-270 to 1370°C 454 to 2500°F	-160 to 1260°C -256 to 2300°F	0.01°C 0.1°F	±(0.005%+0.1°C) ±(0.005% +0.18°F)
Tc type T	-270 to 400°C -454 to 760°F	-130 to 400°C -238 to 752°F	0.01°C 0.1°F	±(0.005%+0.1°C) ±(0.005%+0.18°F)
Tc type R	-50 to 1760°C -60 to 3200°F	150 to 1760°C 302 to 3200°F	0.01°C 0.1°F	±(0.005%+0.2°C) ±(0.005%+0.36°F)
Tc type S	-50 to 1760°C -60 to 3200°F	170 to 1760°C 338 to 3200°F	0.01°C 0.1°F	±(0.005%+0.2°C) ±(0.005%+0.36°F)
Tc type B	50 to 1820°C 140 to 3310°F	920 to 1820°C 1688 to 3308°F	0.01°C 0.1°F	±(0.01%+0.3°C) ±(0.01%+0.54°F)
Tc type C	0 to 2300°C 32 to 4172°F	0 to 2000°C 32 to 3632°F	0.1°C 0.1°F	±(0.01%+0.2°C) ±(0.01%+0.36°F)
Tc type G	0 to 2300°C 32 to 4172°F	190 to 2300°C 374 to 4172°F	0.1°C 0.1°F	±(0.01%+0.3°C) ±(0.01%+0.54°F)
Tc type D	0 to 2300°C 32 to 4172°F	0 to 2130°C 32 to 3866°F	0.1°C 0.1°F	±(0.01%+0.3°C) ±(0.01%+0.54°F)
Tc type U	-200 to 400°C -330 to 760°F	-160 to 400°C -256 to 752°F	0.01°C 0.1°F	±(0.005%+0.1°C) ±(0.005%+0.18°F)
Tc type L	-200 to 760°C -330 to 1400°F	-200 to 760°C -328 to 1400°F	0.01°C 0.1°F	±(0.005%+0.1°C) ±(0.005%+0.18°F)
Tc type N	-270 to 1300°C -450 to 2380°F	0 to 1300°C 32 to 2372°F	0.01°C 0.1°F	±(0.005%+0.1°C) ±(0.005%+0.18°F)
Tc type E	-270 to 1000°C -454 to 1840°F	-200 to 1000°C -328 to 1832°F	0.01°C 0.1°F	±(0.005%+0.1°C) ±(0.005%+0.18°F)
Tc type F	0 to 1400°C 32 to 2560°F	0 to 1400°C 32 to 2552°F	0.01°C 0.1°F	±(0.005%+0.1°C) ±(0.005%+0.18°F)
Pt100 IEC QIML, 3926	-200 to 850°C -330 to 1570°F	-200 to 850°C -328 to 1562 °F	0.01°C 0.1°F	±(0.005%+0.05°C) ±(0.005%+0.09°F)
Pt100 a 3902	-200 to 650°C -330 to 1210°F	-200 to 650°C -328 to 1210°F	0.01°C 0.1°F	±(0.005%+0.05°C) ±(0.005%+0.09°F)
Pt100 JIS SAMA	-200 to 600°C -330 to 1120°F	-200 to 600°C -328 to 1112°F	0.01°C 0.1°F	±(0.005%+0.05°C) ±(0.005%+0.09°F)
Pt 200	-200 to 850°C -330 to 1570°F	-200 to 850°C -328 to 1562°F	0.01°C 0.1°F	±(0.005%+0.15°C) ±(0.005%+0.27°F)
Pt 500	-200 to 850°C -330 to 1570°F	-200 to 530°C -328 to 986°F	0.01°C 0.1°F	±(0.005%+0.1°C) ±(0.005%+0.18°F)
Pt1000 IEC QIML	-200 to 850°C -330 to 1570°F	-200 to 850°C -328 to 1562°F	0.01°C 0.1°F	±(0.005%+0.1°C) ±(0.005%+0.18°F)
CU10	-70 to 150°C -100 to 310°F	-70 to 150°C -94 to 302°F	0.1°C 0.1°F	±(0.01%+0.4°C) ±(0.01%+0.72°F)
CU100	-180 to 150°C -300 to 310°F	-180 to 150°C -292 to 302°F	0.1°C 0.1°F	±(0.01%+0.05°C) ±(0.01%+0.09°F)
Ni100	-60 to 180°C -80 to 360°F	-60 to 180°C -76 to 356°F	0.1°C 0.1°F	±(0.01%+0.05°C) ±(0.01%+0.09°F)
Ni120	0 to 150°C 32 to 310°F	0 to 150°C 32 to 302°F	0.1°C 0.1°F	±(0.01%+0.05°C) ±(0.01% +0.09°F)
mV		-20 to +200mV	0.1µV	±(0.0035% +1µV)
mV		-0.2 to +2 V	1 µV	±(0.005%+10 µV)
V		-2 to +20 V	10mV	±(0.005%+0.08mV)
mA (In)		-5 to +50mA	0.1µA	±(0.005%+0.4µA)
mA (Out)		0 to +50mA	0.1µA	±(0.005%+0.4µA)
Ω IN		0 to 500 Ω	1mΩ	±(0.005%+12mΩ)
		0 to 5000 Ω	0.01Ω	±(0.005%+120mΩ)
Ω OUT		0 to 500 Ω	1 mΩ	±(0.005%+12mΩ)
		0 to 5000 Ω	0.01Ω	±(0.005%+120mΩ)
Frequency		1 to 200 Hz	0.001 Hz	±(0.005% +0.001Hz)
		1 to 2 Hz	0.01	±(0.005% +0.001Hz)
		1 to 20 Hz	0.1 Hz	±(0.005% +0.001Hz)
Pulse counter		0 to 10 ⁵ counts	1 count	infinite
Pulse (Out)		0 to 6000 pulse/min	1 pulse/min	1 pulse/min
		0 to 36000 pulse/h	1 pulse/h	1 pulse/min

Note:

- The relative accuracies shown above are stated for 360 days and the operative conditions are from +18°C to +28°C
- Typical 90 days relative accuracy can be estimated by dividing the "% of reading" specifications by 1.6.
- Typical 2 years relative accuracy can be estimated by multiplying the "% of reading" specifications by 1.4.
- All input ranges: additional error ±1 digit.

B. GENERAL FEATURES

B.1 Innovative design

Calys calibrators use innovative electronics based on a powerful 32 bit microcontroller and sophisticated high stability, low level signal, thermal e.m.f. free analog circuit. A Flash memory allows firmware updating through serial interface and modem.

Calys 1200 and **Calys 1500** incorporates a real time clock, PCMCIA Memory Card slot and improved performances.

B.2 Flexibility

The operative set-up mode is simplified by a sequence of menu pages that only require **<Select>** and **<Enter>** instructions. A full set of operators notes are memory stored allowing a direct operator's assistance and instructions. Any relevant instruction may be recalled through the **<Help>** key. Separate terminals for Channel 1 and Channel 2 are installed on the front panel. The instrument accepts 2, 3, 4 wires resistance thermometers.

B.3 Keyboard & Display

A thermoformed metal-click polycarbonate membrane keyboard, with a working life of one million operations per key, seals the internal electronics from the surrounding environment.

Contact closure of the membrane keys is acknowledged as a coded signal directly by the microprocessor.

The setting of the simulation signal value uses the typical **AOIP sas** in-line single digit setting mode or a direct numerical entry mode.

The high contrast LCD graphic display, equipped with a backlight device, allows easy reading even in poor light conditions.

The graphic display allows a simultaneous indication of the measured and simulated value (large digit), together with a comprehensive number of messages related to engineering units, type of sensor or signal, temperature scale, cold junction selection and battery level of charge.

A backlight auto power OFF mode is installed to save battery life.

A swap feature is also installed to change the position on the display of the IN and OUT parameters.

B.4 Digital serial interface

It is a full bidirectional TTL level digital interface for communication with computerized systems.

A RS232 adaptor with galvanic insulation is available on request.

B.5 Firmware

The real time clock, Flash Memory and RAM handle logic functions, mathematical computation and data storage.

The firmware includes the following capabilities:

- multiple measurements and generation mode
- signal processing: filter, average, peak, alarms
- **downloadable test procedure (CalpMan)**
- **data acquisition (LogMan)**
- switch test routine
- ramping and stepping for dynamic testing
- **user definable linearisation (LinMan)**
- **user entry of probe specific calibration coefficients (LinMan)**

B.6 Scale factor & Square root

All non temperature ranges are fully programmable to read both measured and output values in term of engineering unit.

Four characters, adjustable in an alphanumeric way, are available on the display to show the symbol of the parameter (i.e. mbar, % RH, % CO, etc.) mA reading and output can be eg. related to flow when using a ΔP transmitter across a calibrated flange.

B.7 Cold Junction compensation

Accurate and fast response automatic internal R_j compensation through a special low thermal capacity design of binding posts incorporating a thin film high accuracy Pt100.

The cold junction temperature is measured, acknowledged by the microprocessor, directly displayed for automatic R_j compensation.

In addition to the automatic internal R_j compensation two alternative compensation modes can be selected: "external" with a programmable temperature value or "remote" automatic with an external resistance thermometer.

B.8 Calculated readings

To allow measurements of unstable input signals by a programmable averaging of a programmable number of conversions and min and max value identification.

A "hold" function is also present on the keyboard or external contact instructions.

B.9 Transmitter simulation and calibration

The instrument can be connected to system inputs to simulate a 4-20 mA transmitter. It has an adequate power to drive 20 mA into a load of 1000 Ω in the source mode (50 mA su 350 Ω). The operator can set and change temperature values while obtaining the equivalent mA output.

The mA mode may be connected directly either on passive or on active loops.

B.10 Frequency - Counts

The "Out" mode is designed to generate zero based pulses, with an adjustable amplitude, at a frequency up to 20 KHz.

A preset number of pulses may be programmed and transmitted to test or calibrate totalizers and counters.

The instrument can be configured to measure frequency and count pulse (totalizer mode). Technical units in Hz, pulse/h and pulse/min. The input threshold is adjustable from 0 to 20 V with 0.01 V resolution.

B.11 Programmable signal converter

The instrument can be used as a temporary signal convert replacement. Any input signal (including the remote auxiliary inputs) can be converted into any of the available output signals while maintaining full galvanic isolation.

B.12 2,3,4 wire resistance thermometer

Although resistance and temperature with resistance thermometer may be measured on a 2, 3 wire connection, the instrument is also designed for 4-wire measurements with a resolution as low as 0.01°C.

B.13 Remote temperature probe

A high accuracy probe is available on request for general purpose temperature measurement and/or remote cold junction compensation.

B.14 Graphic mode

To obtain a real time graph of the measured parameter.

The input data are memory stored and the actual values, relevant to the required time, can be digital displayed using the cursor key.

B.15 Simulation programs

Menu-driven set up to generate:

- a continuous or step ramp output where the total time, the starting point, the final point and the size of the steps are requested by the set-up procedure to run the program;
- a repetitive programmable cycle rises, soaks, falls;
- a manual requested increment through keyboard;
- an automatic sequence of up to 20 stored values (2 groups of 10 memories).

B.16 Power supply

External charger circuit and internal rechargeable battery. The instrument can operate from mains line continuously without removing the battery. When in normal operation from mains supply the battery is not recharged. To recharge the battery the instrument must be switched off.

B.17 Report of Calibration

Each instrument is factory calibrated against AOIP sas Standards, that are periodically certified by an International recognized Laboratory to ensure traceability, and shipped with a Report of Calibration stating the nominal and actual values and the deviation errors.

A special calibration report can be supplied on request.

C. PHYSICAL DESCRIPTION

The **Calys 1xxx** series calibrator consists of a rugged and compact case, a mother board with all base and IN/OUT circuits, a tactile polycarbonate membrane keyboard, a LCD display and a group of four Ni - Cd rechargeable batteries.

The internal surface of the case is metal coated through a special process to improve the characteristics of electrical noise shielding and thermal equalization of all internal circuits.

On the **Calys 1xxx** series the battery container is located on the upper part of the case, and it is accessible through a cover with two fasteners.

The two sections of the case are joined together and fastened by five metal screws located on the bottom part of the case.

The optional leather case, with shoulder strap, assures better protection of the instrument against mechanical knocks or scratches.

D. FUNCTIONAL DESCRIPTION

The calibrator functional block diagram is shown below.

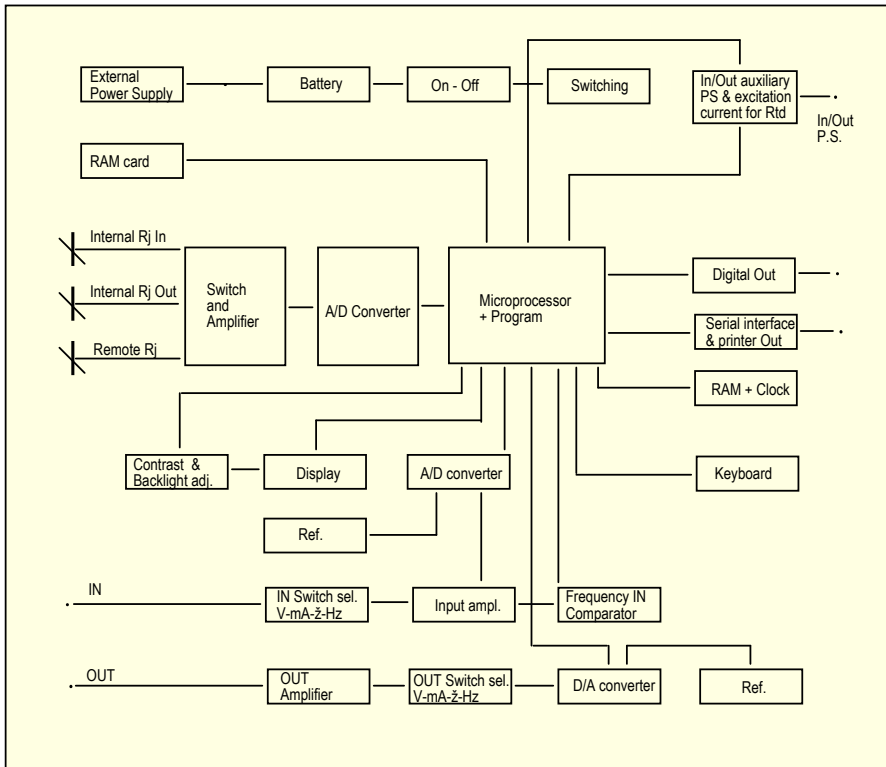

- external power supply module
- microprocessor (central unit + program)
- input circuit
- reference junction compensators (Rj)
- LCD display
- operative keyboard
- analog to digital converter
- digital to analog converter
- auxiliary power supply at 24 Vdc
- RAM + Clock (optional on Calys 1000 , standard on Calys 1200 and Calys 1500)

D.1 Power supply

The instrument is powered by a group of four internal rechargeable Ni-Cd batteries.
 The battery is charged through an external power supply module.
 When required the instrument can be powered directly from the mains line without removing the batteries.
 Pressing the **<ON>** key you will provide the dc voltage levels for the circuitry of the instrument:

IN Circuits

- + 24 V analog circuit
- + 5 V digital/analog circuit
- 10 V analog circuit
- auxiliary power supply In

OUT Circuits

- + 24 V analog circuit
- + 5 V digital/analog circuit
- 5 V analog circuit
- 10 V analog circuit
- auxiliary power supply Out

Two separate groups of voltage levels respectively for Channel 1 and Channel 2 circuits.
 A galvanic insulation of 250 Vac is present between the two group of voltage levels.

D.2 Operative keyboard

million operations per key.
 The contact closure of the membrane keyboard is acknowledged as a coded signal by the microprocessor that recognizes the operators' instructions .
 The ergonomics are simplified with a reduced number of instruction keys referring to the display for additional set-up instructions.

CALYS 1000/1200 FUNCTIONAL DESCRIPTION
CALYS 1500



Ch-IN	IN terminals
Ch-OUT	OUT terminals
ON	Power ON switch
OFF	Power OFF switch
STO	Memory load
RCL	Memory data recall
↔	Parameter scanning during selection or decimal point position setting
0.....9	Single digit setting, numerical entry, parameter scanning during selection, IN/OUT memories
SELECT	Operative menu-driven set-up
±	Polarity simulation setting or parameter scanning during selection
,	Decimal point simulation setting
IN/OUT	Abilitates IN/OUT configuration set-up
MENU	Scrolling of auxiliary operative modes
ENTER	Memory load - Operator's message acknowledgement
SHIFT	Key secondary function
STATUS	To view the pages of the actual installed operative mode and of memory stored data
HELP	Operator's instruction menu pages
NUM	Direct numerical setting of the simulated value
LAMP	To switch the display backlight
RAMP	To start the simulation program
↻	IN and OUT displaying position swapping
ENTER + <4> or <9>	Display contrast adjustment
ENTER + <±> or <,>	Display backlight intensity adjustment

D.3 Input circuit

The A/D converter is a monolithic 20 bit ADC which uses a sigma delta conversion technique.

The analog input is continuously sampled by an analog modulator whose mean output duty cycle is proportional to the input signal.

The modulator output is processed by an on-chip digital filter with a six-pole Gaussian response, which updates the output data register with 20-bit binary words at word rates up to 4 kHz. The sampling rate, filter corner frequency and output word rate are set by a master clock input supplied externally from a dedicated quartz with frequency multiple of 50/60 Hz to improve noise rejection.

The inherent linearity of the ADC is excellent (0.003%), and the endpoint accuracy is ensured by a self-calibration of zero and a full scale which is started every 5 minutes.

The self-calibration scheme can also be extended to null system offset in the input channel.

Output data are accessed through a serial port by the microprocessor in a synchronous mode.

CMOS/HCCMOS construction ensures a low power dissipation and high speed.

Analog switches provide for the gain and input parameter selection.

The front end amplifier is a high performance amplifier with very low noise and zero-drift with a combination of low-front-end noise and dc precision and it is followed by an autozero circuit.

The internal nulling clock is set at 5 KHz for an optimum low frequency noise and offset drift.

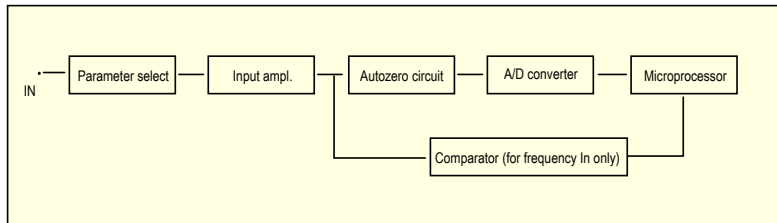

D.4 Microcontroller

The microcontroller handles all the logic functions of the instrument, performs the linearization for non linear transducers, compensates for the reference junction temperature, drives the digital display and acknowledges all the operator's instructions.

The core of the circuit is the MC68332; a 32 bit integrated microcontroller, combining high performance data manipulation capabilities with powerful peripheral subsystems and featuring a fully static, high speed complementary metal oxide semiconductor (HCMOS) technology.

The MC68332 contains intelligent peripheral modules such as the time processor unit (TPU), which provides 16 microcoded channels to perform time related activities from a single input capture or output compared to sophisticated pulse width modulation (PWM).

High speed serial communications are provided by the queued serial module (QSM) with available synchronous and asynchronous protocols.

Two kilobytes of fully static standby RAM allow a fast two cycle access for system and data stacks and for variable storage with provision for battery back-up.

Twelve chip selections enhance system integration for fast external memory or peripheral access.

These modules are connected on-chip via intermodule bus (IMB)

D.5 Firmware

The operating firmware system (256 Kbyte memory) is divided in to two sections:

- one section contains the **boot-loader** that is a routine to enable the base firmware loading through the serial port
- the second section contains **the base firmware** that handles all logic instructions for internal peripheral circuits and performs the computation of the linearization equations. Moreover it contains the **"Help"** key operator's instructions and gives instructions to the secondary graphic controller for the character generation.

The application system firmware (eg. calibration data) is resident on a non-volatile "Flash" EPROM.

It is used to store the installation parameters (calibration data, simulation program data, etc.)

D.6 Digital display

The Liquid Crystal Display module is a graphic display with high contrast and a wide viewing angle.

It is equipped with a LED backlight device to allow easy readings also in poor light conditions.

The character generation is made through the main microprocessor that gives pertinent instructions to a secondary microprocessor driving the display in a graphic mode.

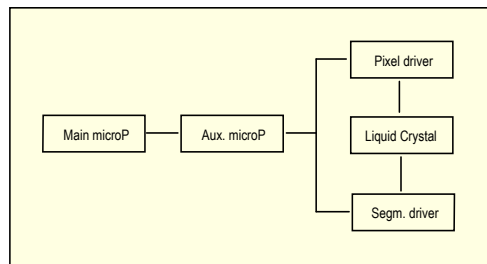

D.7 Digital to analog converter

The D/A converter is based on a joint configuration, with a partial overlapping, of a 10-bit and 12-bit converter to obtain a ± 21 bit resolution .
 The two digital to analog converters are designed using the two PWM (pulse with modulation) processes available in the microprocessor chip.
 These two PWM outputs drive the relevant switches to generate a voltage output proportional to Ton or Toff with an accuracy theoretically absolute.
 The resultant ± 21 bit D/A device, driven directly by the microprocessor, converts the digital value of the selected parameter into an analog voltage output function of the time modulation of the PWM and of the internal high stability, high accuracy reference.
 Analog switches are used to select one of the following six available output values as a function of the selected range:

-20	to	+200	mV
-2	to	+20	V
-200	to	+2000	mV
0	to	500	Ω
0	to	5	K Ω
0	to	50	mA

The above signal, through an output buffer, is sent to an integrated circuit that will generate the voltage or current requested by the operator's keyboard settings.

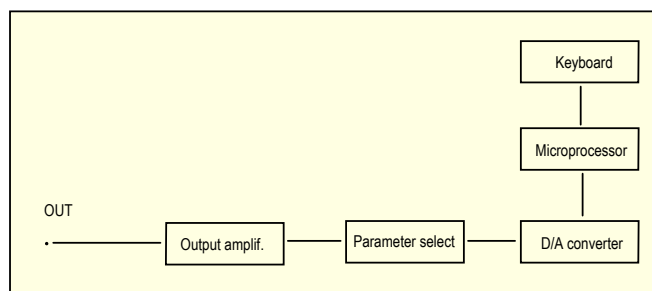

D.8 External battery charger or mains line operation

The instrument is equipped with an external power supply module for line operation 100, 120, 240 Vac 50/60 Hz.
 The external power supply module uses a step down transformer, a rectifier, a filter, a serial current controller, protection sections for overcurrent and a battery charge circuit equipped with a timer for three different ways of charge driven by the battery status.
 The charging circuit uses two different references for:

- voltage control to 5.5 Vdc during instrument operations (5 V dc internal lines)
- battery charge current controller with a maximum of 1 Adc (when the instrument is switched Off) and a maximum of 1.8 A , limited to 5.5 V with the instrument switched On.

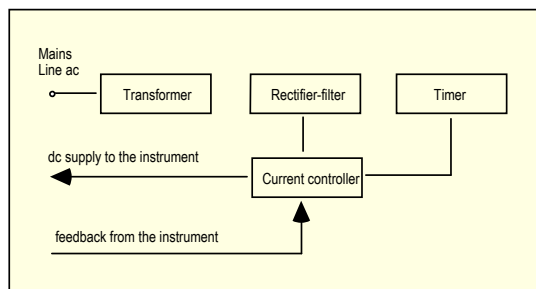

D.9 Digital interface

The serial digital interface circuit is essentially based on the serial communication interface subsystem (SCI) on the chip of the microprocessor (0 to +5V level).
 An external adaptor is available on request to convert TTL to RS 232 voltage levels .

D.10 Resistance and Rtd measurements

The instrument can measure temperature with 2, 3 or 4 wire resistance thermometers.
 For the 2 and 4 wire resistance thermometers the method used is a special configuration of a potentiometric circuit where a constant current is injected from terminals "I+" and "I-" and the voltage drop across the thermometer is measured and converted in engineering unit.
 With 3 wire thermometers a current equivalent to that generated on terminal "I+" is injected on terminal "V-" to compensate for connecting cable unbalance.

- A O---- I +
- B O---- V +
- C O---- V -
- D O---- I -

D.11 Resistance and Rtd simulation

This line of calibrators is equipped with a proprietary electronic circuit for the active simulations of platinum resistance thermometers, nickel resistance thermometers, copper resistance thermometers and resistances.

It is based on the assumption that the instrument to be calibrated will supply the excitation current to the sensor; this current must be between 0.1 and 2 mA for up to 100 Ω nominal value Rtd and between 0.01 mA and 0.5 mA for Pt1000 and K Ω ranges.

A lower value will cause a lower accuracy level and a higher current will not allow the simulation of high resistance values (the maximum voltage drop on the simulated resistance is 2.5 V).

The excitation current must be applied to the pertinent terminals as indicated in par. 7.1 (simulation).

The measured current is converted to voltage through an inverting amplifier and used as a reference for the digital to analog converter.

The output amplifier will simulate the variation of the output resistance as a function of the value set by the operator through the keyboard.

D.12 Thermocouples input/output circuit

A thermocouple is a temperature sensor that in its most common form, consists of two wires of different composition, joined together at one end ("measuring" junction).

The two free ends of the thermocouple must be kept at the same known temperature. These joints are, by definition, the "reference" junction (Rj).

The reference junction is also often, but less preferably, called the "cold" junction.

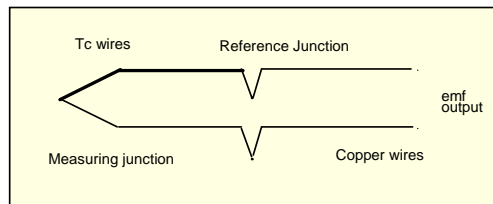

The temperature of the reference junction can be held constant or its variation can be electrically compensated in the associated measuring instrumentation.

A thermocouple is useful for temperature sensing because it generates a measurable electrical signal.

The signal is proportional to the difference in temperature between the measurement and the reference junctions and it is defined, by means of tables, based on the International Temperature Scale.

The **Calys 1xxx** series has the reference junction located in the negative (black) terminal post. To improve overall accuracy the terminals are designed with a very low thermal capacity.

Inside the body of the negative terminal it is placed a thin film Pt100 resistance thermometer that dynamically measures, with high accuracy and 0.01°C resolution, the temperature of the reference junction.

The microprocessor uses the above signal (Pt100) to adjust the input signal to compensate for the Rj temperature.

Reference junction compensation can be internal, external or remote, depending upon the application requirements.

E. PRE-OPERATIONAL CHECK

E.1 Unpacking

Remove the instrument from its packing case and remove any shipping ties, clamps, or packing materials.

Carefully follow any instructions given on any attached tags.

Inspect the instrument from scratches, dents, damages to case corners etc. which may have occurred during shipment.

If any mechanical damage is noted, report the damage to the shipping carrier and then notify **AOIP sas** directly or its nearest agent, and retain the damaged packaging for inspection.

A label, on the back of the instrument case, indicates the serial number of the instrument. The serial number is also shown in the display.

Refer to this number for any inquiry for service, spare parts supply or application and technical support requirements.

AOIP sas will keep a data base with all information regarding your instrument.

E.2 Case

The instrument case, made in shock-resistant injection moulded ABS has an internal metal coating for electric interference protection. It allows the use of the instrument in three different ways:

- portable with leather case for an easy transport
- table top with tilting feet
- panel mounted (DIN cut-out)

A leather protection case is supplied as an option only on request.

E.2.1 Portable cases

Two different leather cases, with cover and shoulder strap, are available on request for the instrument alone or instrument, printer and accessories. These are extremely useful for a practical use since they allow to leave one hand free for instruments under test tuning.

Catalog n. BB880015 is used with the instrument alone while catalog n. BB880011 has a zoom for the instrument, printer and accessories.

E.2.2 Panel mounting

For panel mounting each instrument is supplied with two mounting brackets to be installed on the two sides of the case.

The instrument bezel flange butts against the front of the mounting plate; the mounting brackets fit over the instrument rear panel.

The bracket screws force it against the rear of the mounting panel, locking the instrument in place.

Panel cut-out dimensions are 242 x 88 mm (max. panel thickness 6 mm).

Rack mounting adaptors (112 x 433 mm) are available with openings for two instruments.

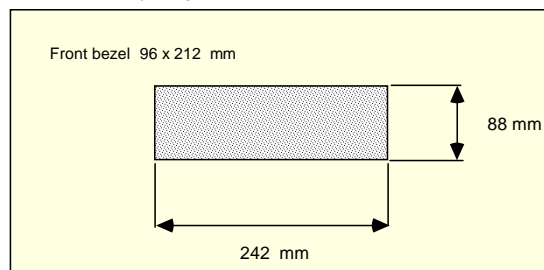

E.2.3 Table top

The case is equipped with 2 pivot feet to change the vertical viewing angle when using the instrument on the top of the table.

F. POWER SUPPLY

F.1 Power supply and rechargeable battery

The **Calys** calibrator is powered by four built-in rechargeable batteries. The instrument is shipped with an average level of charge.

Note: After unpacking, a full charge of the batteries is recommended; connect the instrument to the charger module ("Off" condition) for a period of 8 hours minimum. Energize the display backlight device only in poor light conditions to limit battery discharge.

The Ni-Cd rechargeable batteries do not suffer when used in cyclic operations.

The cyclic operation is understood as a method of operation by which the battery is continually charged and discharged.

Avoid leaving the instrument, with batteries totally or partially discharged, for a long time without recharging. In case of "low battery" (voltage lower than 4.6 V) the display will show the warning message indicated below and an acoustic signal (internal buzzer) will inform the operator that he has only few additional minutes of operation and then the battery should be recharged.

At "low battery" condition the display shows a small battery symbol.

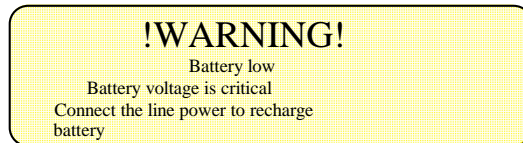

F.1.1 Charging the battery

Battery is only partially charged at the time of purchase. Therefore charge it before using your calibrator.

A total discharge of the battery before recharging it, will allow the battery to be charged to its highest capacity. When not in use, the battery slowly discharges. When not in use for a long period, the battery may be completely discharged. The battery self-discharge time is minimum 2, maximum 6 months it depends, upon battery efficiency and environment conditions.

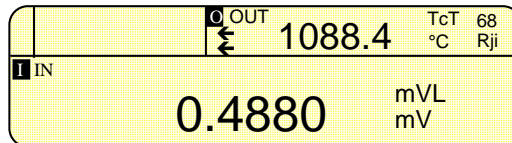

A "plug" symbol on the upper-left side of the display indicates that the battery charging process is active.

A -red- LED, inside the battery charger module, indicates that the charging process is active. A -green- LED, inside the battery charger module, indicates that the power supply is connected.

!! WARNING !!

IF THE BATTERIES ARE COMPLETELY DISCHARGED, YOU HAVE TO RECHARGE IT WITH THE UNIT SWITCHED OFF.

A FULL BATTERY CHARGE IS OBTAINED IN 4 HOURS AT 90% WITH THE INSTRUMENT SWITCHED OFF.

WHEN OPERATING THE INSTRUMENT WITH LINE POWER SUPPLY, THE BATTERY CHARGE LEVEL IS LIMITED TO 50% MAXIMUM.

F.1.2 How to maximize the life span of the battery

Disconnect the external module from ac mains supply when the battery is charged. Use the battery until it is completely discharged. Note that the operating time decreases at low temperatures.

A Ni-Cd battery can be recharged about 500 times when used following the recommended instructions.

When replacing the Ni-Cd batteries with a new set always replace simultaneously the four pieces.

For long period of storage it is also recommended to keep the instrument at temperatures below 40°; higher temperatures accelerate the battery self discharging process and derate battery performances.

F.2 Line operation

The external power supply module allows direct mains line operations without the battery removal. The battery level of charge is kept at approximately 50% of the full charge. If the line power is connected with batteries completely discharged, these will not be recharged with the instrument switched on.

The symbol  will appear on the upper left side of the display. The external power supply module can be configured for line voltage of 100, 120, 240 V $\pm 10\%$ 50/60 Hz.

G. ELECTRICAL CONNECTIONS

Appropriate extension wires should be used between the thermocouple (or instrument under calibration) and the **Calys 1000** unless the thermocouple leads permit direct connection.

Make sure that both thermocouple and compensating cable are connected with the correct polarity.

If in doubt, the polarity of the compensating leads can be checked by connecting a length of lead to the indicator, shortening the free ends of the wires together and noting that the indicator reading increases when the wire connection is heated.

Colour codes of compensating cables change in different countries. Check the appropriate table.

For Rtd connection use a cable of adequate gauge to lower the overall input resistance.

The use of a cable with a good resistance balance between conductors is also necessary.

G.1 Wiring practice

Although the **Calys 1000/1200** and **Calys 1500** calibrators are designed to be insensitive to transients or noise, the following recommendations should be followed to reduce ac pick up in the signal leads and to ensure a good performance. The input leads should not be run near ac line wiring, transformers and heating elements.

Input/output leads should, if possible, be twisted and shielded with the shield grounded at the end of the cable.

When shielded cables are used the shield must be connected to the negative terminal.

For a better understanding of the appropriate connection when using the instrument to simulate current into industrial 2 wire loop please, note the meaning of the terminal used.

Passive loop

This type of connection is to be used when the external loop is not equipped with the loop power supplied.

The calibrator can be, as an example, connected directly to a recorder, controller, etc. with input circuits configured for current measurements.

Active loop

This type of connection must be used when the external loop is equipped with its loop power supplied.

The power supply is not required to be disconnected.

The loop circuit must be opened and the **Calys 1000/1200** and **Calys 1500** connections are placed in series on the loop.

The following figure shows some examples of input/output wiring of the instrument:

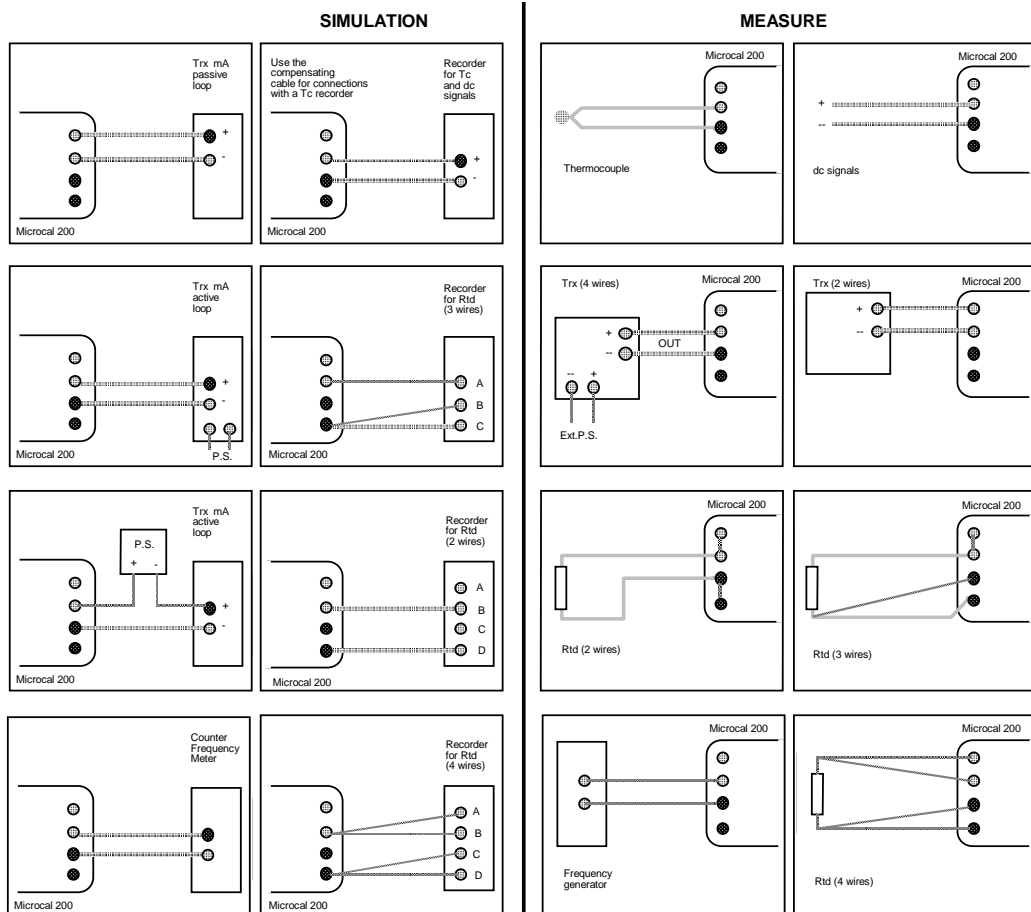

G.2 Thermocouple wires

When making measurements where additional wires have to be connected to the thermocouple leads, care must be exercised in selecting these wire types, not only when they are claimed to be of the same composition as the thermocouples involved, but, also, of their same "quality".

Performance results, where high precision is required and in circumstances where some types of thermocouple wire leads are added to the original installation, should be reviewed carefully for the impact of the choice of the additional wire leads.

The quality of the thermocouple wire is established by the limit of error to be expected with its use.

There are three recognized levels of quality:

- Special or Premium grade
- Standard grade
- Extension wire grade

The error limits determining the grade quality differ from thermocouple type to thermocouple type, reflecting the degree of difficulty in maintaining the precise levels of purity of the metal used.

The table below summarizes the error limits for Premium and Standard grades, while the Extension Grade wire is characterized by limits of error exceeding those in the table.

Errors up to ± 2.5 °C may be experienced when using Extension grade thermocouple wire for J and K thermocouples.

Thermocouples Limit of Error

The tolerance and the e.m.f. versus temperature reference table are defined by the IEC 584-2(Cenelec HD 446,2) and listed as it follows:

Tolerance is meant as the maximum deviation, in °C, from the above indicated reference table with reference Junction at 0°C and the measuring junction at an appropriate temperature.

The range indicated is the temperature limit for the indicated relative errors.

Reference junction at 0 °C.

Tc	Class 1	Class 2	Class 3
type T	$\pm 0.5^{\circ}\text{C}$ (-40 to +125°C) $\pm 0.004 \cdot T$ (T >125°C)	$\pm 1^{\circ}\text{C}$ (-40 to 133°C) $\pm 0.0075 \cdot T$ (T >133 °C)	$\pm 1^{\circ}\text{C}$ (-67 to 40°C) $\pm 0.015 \cdot T$ (T <-67°C)
T range	-40 to +350°C	-40 to +350°C	-200 to 40°C
type E	$\pm 1.5^{\circ}\text{C}$ (-40 to 375°C) $\pm 0.004 \cdot T$ (T >375°C)	$\pm 2.5^{\circ}\text{C}$ (-40 to 333 °C) $\pm 0.0075 \cdot T$ (T >333°C)	$\pm 2.5^{\circ}\text{C}$ (-167 to +40°C) $\pm 0.015 \cdot T$ (T <-167°C)
T range	-40 to 800°C	-40 to 900°C	-200°C to 40°C
type J	$\pm 1.5^{\circ}\text{C}$ (-40 to 375°C) $\pm 0.004 \cdot T$ (T >375°C)	$\pm 2.5^{\circ}\text{C}$ (-40 to 333 °C) $\pm 0.0075 \cdot T$ (T >333°C)	
T range	-40 to 750°C	-40 to 750°C	
type K & N	$\pm 1.5^{\circ}\text{C}$ (-40 to 375°C) $\pm 0.004 \cdot T$ (T >375°C)	$\pm 2.5^{\circ}\text{C}$ (-40 to 333 °C) $\pm 0.0075 \cdot T$ (T >333°C)	$\pm 2.5^{\circ}\text{C}$ (-167 to +40°C) $\pm 0.015 \cdot T$ (T <-167°C)
T range	-40 to 1000°C	-40 to 1200°C	-200°C to 40°C
type R & S	$\pm 1^{\circ}\text{C}$ (0 to 1100°C) $\pm 1 + 0.003 (T-100)$ (T >1100°C)	$\pm 1.5^{\circ}\text{C}$ (-40 to 600 °C) $\pm 0.0075 \cdot T$ (T >600°C)	
T range	0 to 1600°C	0 to 1600°C	
type B			$\pm 4^{\circ}\text{C}$ (600 to +800°C) $\pm 0.005 \cdot T$ (T>800°C)
T range		$\pm 0.0025 \cdot T$ (T >600°C) 600 to 1700°C	$\pm 0.005 \cdot T$ (T>800°C) 800 to 1700°C

Special selected premium grade wires are available on request.

G.3 Remote connections

G.3.1 External switch input

The instrument is equipped with a contact switch programmable for several functions

The type and mode of the event can be programmed (see par. 8.6) for operations:

Cnct Fnct = none / hold In / hold InP / ons IN / ons OUT / swtc In / swtc InP / swtc OUT

When the "Contact" function is selected the type of contact should be programmed as it follows:

Cnct STATE = n. open (normally open)

Cnct STATE = n. closed (normally closed)

The remote contact must be wired to the pin 11 (Contact +) and 24 (Contact -) of the back panel connector.

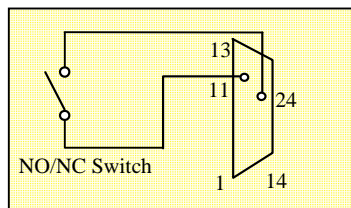

G.3.2 Rj remote

The instrument can also operate with a remote cold junction (Rj) compensation. This operative mode require an external Pt100 to be wired to pin 9 (Rj rem B) and 22 (Rj rem C) and pin 10 (Rj rem A) of the back panel connector as indicated in the figure/table below.

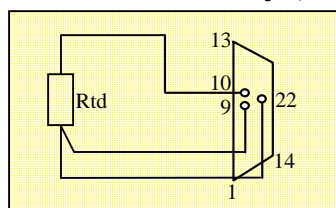

H. OPERATION & APPLICATIONS

The **Calys 1000/1200** and **Calys 1500** calibrators have been factory calibrated before shipment. During the start-up the operator should only select and load the required application parameters as described below. If the instrument has been manufactured with a special thermocouple linearization, and/or with a special hardware, see also notes in the Appendix. The instrument should be used in environments where the temperature does not exceed the specified limits (from -10 °C to +55 °C) and where the relative humidity is lower than 95%

Note: All numeric values shown in the figures of this manual are listed as an example.

During the set-up and memory loading remember that the instructions of the manual related to key operation have the following meaning:

- **<A> + ** Press the **<A>** key and keeping the pressure on it, press then the **** key.
- **<A>, ** Press in sequence first the **<A>** key and then the **** key.

If an operative message (eg. "Instrument config", "Set", "Esc", etc.) is present under the **<NUM>** or **<LAMP>** or **<RAMP>** key this instruction can be entered pressing the corresponding key.

H.1 Power-ON

To power the instrument on press the **<ON>** key; the following indication will appear for few seconds.

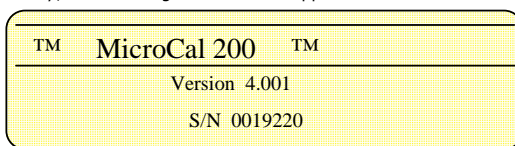

The instrument will run an autodiagnostic routine for the self-checking of critical circuits and components. The serial number, the version number of the firmware installed on the instrument and the next calibration date are important pieces of information for servicing activities.

To achieve a better performance in terms of accuracy wait at least for 5 minutes for the instrument to warm up.

When possible avoid using the display backlight in order to save the charge of the battery and to limit the heating inside the instrument, so that you can obtain the most accurate results.

The instrument is ready for measurement with the previously selected operating mode with, for example, the following indication:

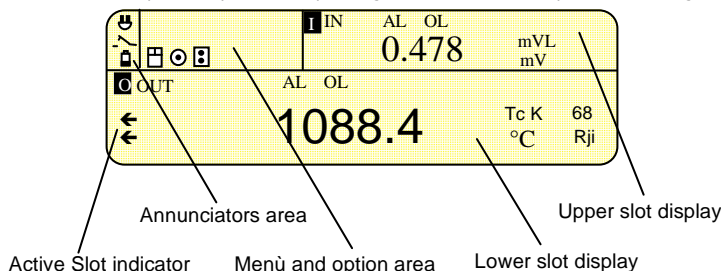







The **Calys 1000/1200** and **Calys 1500** are able to visualize simultaneously on the display, two of the three I/O channels : pressure input (InP), signal Input (IN) and signal output (OUT). Make reference to par. 8.8 and 8.9 for scrolling and swapping operations among the channels.

All the keyboard operations are performed on the active slot display. To activate the desired slot display, press the **<In-Out>** key in order to visualize the two arrow indicator on the slot.

Some graphical symbols could be displayed on the 'annunciators area' or in the 'option area' of the display. They have special meanings.

These symbols are :

-  RAM card (PCMCIA) inserted
-  Low battery indication
-  Pump vacuum mode selected
-  Pressure module connected
-  Switch input status
-  The external battery charger unit is connected to the mains line

H.2 Configuration Reset

It is possible to reset **Calys 1000/1200** and **Calys 1500** to the **AOIP sas** standard configuration pressing **<RCL>** + **<Help>** keys. The instrument will ask to confirm the operation before to reset the instrument. All operator's setting and data will be lose.

H.3 Next Calibration date

The instrument is equipped with a function to warn the operator when a new calibration of the instrument is recommended . By default the next calibration date is factory set at 01/01/80: this date set-up must be used when the warning message is not required.

The "next calibration date" warning is enabled when the relevant date is programmed in the calibration set-up procedure.

When the instrument is powered, during the diagnostic routine, the following page is displayed with the indication of the next programmed calibration date in the bottom line.

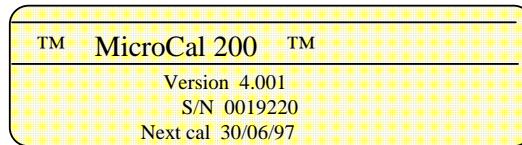

When the programmed next calibration date has expired the instrument, at the start-up, will warn the operator with an acoustic signal and the following message:



Press any key to acknowledge the warning message and to enter the operative mode.

The operator should inform the pertinent service of the organization charged for the instrument recalibration.

H.4 Digital display adjustments

The digital display is a graphic LCD module with high contrast and a wide viewing angle.

It is equipped with a LED backlight device to allow easy reading also in poor light conditions.

Different character sizes are used to differentiate the measured and simulated value from the operative mode and from messages to the operator as indicated below.

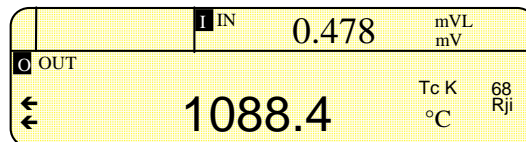

The display contrast can be adjusted using the **<ENTER> + <4>** or **<9>** keys.

The backlight intensity can be adjusted using **<ENTER> + <1>** or **<6>** keys.

Important notes :

- Remember that a high backlight intensity reduces the battery operative live
- Remember that to obtain the maximum performance in term of accuracy the backlight must be switched off. In fact the backlight device is a source of internal heating that can contribute to the overall error of the instrument. The stated relative accuracy is declared with the backlight device switched off.

H.4.1 Display backlight

The backlight of the display can be switched "On" and "Off" using the **<LAMP>** key.

If an operative message is present under the **<LAMP>** key the above operation can be obtained using the **<ENTER> + <LAMP>** key.

H.4.2 Autolamp mode

To save the energy of the battery and to extend the operative life a programmable routine is used to automatically switch "Off" the backlight 5 minutes after the operator's last keyboard instruction.

- To enable (or to disable) the **-Autolamp-** mode press the **<MENU>** key to obtain the **<Instrument Config>** message.
- Press one of the **<Instrument Config>** keys to obtain the following indication.

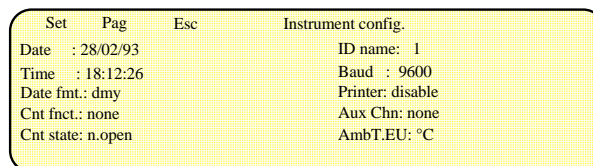

Press the **<Pag>** key to visualize the next page menu

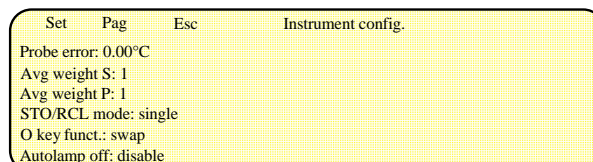

Press the **<0>** or **<1>** key to reach the **- Autolamp -** message

Press the **<Set>** key to enable the parameter change

Press the **<0>** or **<1>** key to select the required "enabled" or "disabled" mode

Press **<Enter>** to acknowledge the selection.

Press the **<Esc>** key to return to the main operative page.

H.5 "Help" key

All the operations on the keyboard are simple and easy; any key action displays both a comprehensive instruction or incorrect operation messages.

To make the operator's task easier during operating modes, the firmware includes a comprehensive instruction manual with a full set of "Help" pages with an immediate indication of pertinent actions required.

Three typical pages obtained when pressing the <HELP> key are:

	<ul style="list-style-type: none"> <Select> Select technical unit or sensor <NUM> Entry numeric value <RAMP> Start programmed ramp <STATUS> View active configuration <MENU> Scroll menu functions <STO>+<ENTER>+<n> Memory store <RCL>+<ENTER>+<n> Memory recall
<p>Pg Esc Set IN Type</p> <p>Lin mVL mVH V mA k Hz puls Ω</p> <p>X X1 X2 X3 X4 X5</p> <p>Tc J K T F R S B U L N E</p> <p>Pt100 IEC OIML USLAB US SAMA JIS</p> <p>Pt 200 500 1000 1000OIML</p>	<p>Set Select ITS Rj °C-°F-K</p> <p>Pg Page selection</p> <p>Esc Return to main page</p> <p><> Select tech.unit or sensor</p> <p><ENTER> Store new selection</p>
<p>Set Esc Set Tc</p> <p>E.U. : °C</p> <p>Rj : internal</p> <p>Rj ext : 0.00°C</p> <p>ITS : 1968</p>	<p>Set Enter selection procedure</p> <p>Esc Return to previous page or keep previous setting</p> <p><> Move function pointer or move through choices</p> <p>(ENTER) Store new selection</p>

H.6 Configuration review (Status)

The actual configuration of the instrument can be easily reviewed.

Press the <STATUS> key to obtain a sequence of pages with the relevant header.

Upper or Lower slot display (basic and internal status) can be selected using the <IN-OUT> key.

Input channel status

Actual operating mode, value, technical unit, minimum value, maximum value and median value with actual positive and negative deviation are displayed.

Rst		Input status	
IN :	0.478 mV	mVL	
MIN:	0.4770		
MAX:	0.4790		
MED:	0.4780		± 10.000 mV

The Minimum and Maximum values can be reset using the <Rst> key.

Output channel status

Actual operating mode, value and technical unit are displayed.

CNV: Convert= electrical signal value equivalent to the technical unit value

Output status	
OUT:	800.8 mbar X1
CNV:	0.000 mV

Press the <STATUS> key to enter the pages relevant to the internal status (respectively to Input channel and Output channel) as it follows:

Internal status

Information related respectively to:

- Rj internal temperature (inside black terminal);
- Rj external (memory stored value);
- Rj remote (indicates the remote temperature when the appropriate Rtd is connected to the back panel connector. If the Rtd is disconnected, the indication will be "Underrange";
- Battery voltage;
- S/N: Serial number of the instrument;
- Boot program version number;
- Firmware version number
- Next calibration date (only when programmed)
- Humidity and ambient temperature (only when programmed)

Internal status OUT	
Rj internal: 21.70 °C	Next cal 09/10/95
Rj external: 0.00 °C	
Rj remote : 15.00 °C	
Hum : 50.0 %RH	Amb T : 15.00 °C
Battery : 5.00 V	
™ MicroCal 200 ™	BOOT vers. 1.001
S/N 0013288	PGM vers. 2.004

Internal status IN		
Rj internal: 21.70 °C		Next cal
Rj external: 0.00 °C		09/10/95
Rj remote : 20.12 °C		
Hum : 50.0 %rH	Amb T : 15.00 °C	
Battery: 5.00 V		
™ MicroCal 200 ™	BOOT vers. 1.001	
S/N 0013288	PGM vers. 2.004	

▪ **X1, X2, X3, X4, X5 Output Set Status**

Five output scale factor configurations can be reviewed.

The parameters considered are:

- Type: signal or sensor
- Low: electrical signal - zero
- High: electrical signal - full scale
- Low x: display scaled zero indication
- High x: display scaled full scale indication
- Fun: linear or square
- E.U.: Symbol of the engineering unit

A typical indication will be the following:

X1 Set status OUT		
Type : mVL		Fun : linear
Low : 0.000	mV	E.U. : rpm
High : 100.000	mV	Prst : none
Low x: 0.000		
High x: 500.000		

Press any <⬅> or <➡> key to select the next or the previous display of the five pages of "X" output status.

▪ **X1, X2, X3, X4, X5 Input Set Status**

From the above "X" Output Set Status pages press the <IN-OUT> key to select the INput "X" Set Status Pages. Five input scale factor configurations can be reviewed.

The parameters considered are:

- Type: signal or sensor
- Low: electrical signal - zero
- High: electrical signal - full scale
- Low x: display scaled zero indication
- High x: display scaled full scale indication
- Fun: linear or square
- E.U.: Symbol of the engineering unit

A typical indication will be the following:

X1 Set status IN		
Type : mVL		Fun : linear
Low : 0.000	mV	E.U. : rpm
High : 100.000	mV	Prst : none
Low x: 0.000		
High x: 500.000		

Press any <⬅> or <➡> key to select the next or the previous display of the five pages of "X" input status.

▪ **Memory status**

From one of the above pages press the <STATUS> key to obtain IN and OUT memory status pages. Four pages with a total of 20 memory stored data items are available both for INput and OUTput data items.

The following is a typical displayed page:

Memory status OUT		
*00: 110.0 °C	Tc K Rjext ITS68	↘
*01: 120.0 °C	Tc K Rjext ITS68	↘
*02: 130.0 °C	Tc K Rjext ITS68	↘
*03: 130.5 °C	Tc K Rjext ITS68	↘
*04: 0.000 mV	mVL	

Press any <⬅> or <➡> key to recall the previous or the next of the OUTput Memory Status pages (rolling 0-4, 5-9, 10-14, 15-19).

Press the <IN-OUT> key to recall the INput Memory Status pages.

Memory status IN		
*00: 0.000 mV	mVL	↘
*01: 0.288 mV	mVL	↘
*02: 0.884 mV	mVL	↘
*03: 8.046 mV	mVL	↘
*04: 2.248 mV	mVL	↘

Press any <⬅> or <➡> key to recall the previous or the following of the INput Memory Status pages (rolling 0-4, 5-9, 10-14, 15-19).

Press the <IN-OUT> key if you require to recall OUTput Memory Status pages.

▪ **Alarm status**

This page allows to review alarm warning conditions announced during operation with an acoustic signal :

- An - ALARM - message will be displayed where applicable.
- The - Ref. junction IN/OUT - is related to the internal automatic Rj compensation.
- The - Overload IN/OUT/InP - is related to anomalous operative condition of the auxiliary power supply (eg. current simulation into an active loop).
- The - Calibration Date - gives a warning when the next calibration date has expired.
- The -Reading In/InP/Out- is related to the alarm function setting (see par. 8.10 for description and setting)

Alarm status

Battery low :
 Reading In :
 Reading InP :
 Reading Out : ALARM
 Overload In :
 Overload InP :
 Overload Out :

Press any <⏪> or <⏩> key to recall the previous or the following Alarm Status pages.

Calys 1000

Alarm status

Calibr. data : NONE
 Ref. Junct. In :
 Ref. Junct. Out :

Calys 1200

Alarm status

Calibr. data : NONE
 Ref. Junct. In :
 Ref. Junct. Out :
 Batt. Low Ramcard :

Calys 1500

Alarm status

Calibr. data : NONE
 Ref. Junct. In :
 Ref. Junct. Out :
 Batt. Low Ramcard :

▪ **Ram status**

Two different pages are available according to the type of instrument

Calys 1000

Ram status

Tcx/Rtdx data : NONE
 Calibr. Procedure data : NONE
 Logging data : NONE
 Logging groups : 0
 Max logging data (100 %) : 1738

Calys 1200

Ram status

Ramcard status : off
 Ramcard size : 128k
 Tcx/Rtdx data : NONE
 Calibr. Procedure data : NONE
 Logging data : NONE
 Logging groups : 0
 Max logging data (100 %) : 1738

Calys 1500

Ram status

Ramcard status : off
 Ramcard size : 128k
 Tcx/Rtdx data : NONE
 Calibr. Procedure data : NONE
 Logging data : NONE
 Logging groups : 0
 Max logging data (100 %) : 1738

The above data are self-explanatory and summarize the operative data/mode present into the instruments

H.7 General configuration set-up

This procedure allows the set-up of the general configuration of the instrument relevant to the parameter indicated below:

- Date** (sets clock date -adjusts month/day/year according to the date format enabled)
- Time** (sets clock time -adjusts hours/minutes/seconds)
- Date fmt** (selects the date format "dmy" or "mdy")
- Cnct fnct** (selects the external contact mode: none, hold, ons OUT, ons IN) ons=one-shot start/stop
- Cnct state** (selects the external contact configuration: n.open (normally open) or n.closed (normally closed))
- ID name** (sets the digital interface machine identification code from 1 to 99)
- Baud** (selects the baud rate among the following: Off - 300 - 600 - 1200 - 2400 - 4800 - 9600 - 19200 - 38400 - 57600 - 115200)
- Printer** (selects "enable" or "disable")
- Aux Chn** (select the external sensor connected to the auxiliary connector among the following: none, humidity)
- Ambt EU** (Set the engineering unit for ambient temperature measured with the humidity/temperature external sensor)
- Probe err** (sets the temperature remote sensor deviation from the actual one for higher accurate temperature measurements)
- Avg weight S** (sets the Average weight value from 1 to 255 for electrical inputs)
- Avg weight P** (sets the Average weight value from 1 to 255 for pressure inputs)
- STO/RCL mode** (selects store and recalls operations simultaneously for single and multiple channels)

AutoLmp (selects display backlight automatic switch-off after 5 minutes)

 **key function** (configure the key to operate in swap (between the 2 slot display) or scroll (between the channels) mode)

- Press the **<MENU>** key to obtain the following indication:

Instrument Config.	I IN	0.478	mVL mV
O OUT		1088.4	Tc K 68 °C Rji

- Press one of the **<Instrument Config >** keys to obtain the following indication.



Set	Pag	Esc	Instrument config.
Date : 28/02/93			ID name: 1
Time : 18:12:26			Baud : 9600
Date fmt.: dmy			Printer: disable
Cnt fnct.: none			Aux Chn: none
Cnt state: n.open			AmbT EU: °C

- Press, if necessary, the **<Pag>** key to visualize the next page menu

Set	Pag	Esc	Instrument config.
Probe error: 0.00°C			
Avg weight S: 1			
Avg weight P: 1			
STO/RCL mode: single			
O key funct.: swap			
Autolamp off: disable			

- Press the **<O>** or **<I>** key to select the parameter to be modified;
 - Press the **<Set>** key to enter the adjustment step;
 - Press the **<O>** or **<I>** key to adjust or modify the selected parameter;
 - Press the **<ENTER>** key to acknowledge and memory store new data;
 - Press the **<Esc>** key to return to the previous page and in the operative mode with the new configuration.
- The new configuration will be held into the memory until the next change.



H.8 Slot display swapping

If the  key is sett for the swapping mode (see par. 8.6), the operator can swap the indication displayed in the upper slot with the lower slot one using the  key; eg. from the display page indicated below:



	I IN	0.478	mVL mV
O OUT		1088.4	°C

Press the  key to obtain the following indication:

	O OUT	1088.4	°C
I IN		0.4780	mVL mV

If the  key is setting for scrolling mode (see par. 8.6), the operator can swap the indication displayed in the upper with the indication in the lower slot by pressing the **<Shift>** +  keys.



H.9 Channels scrolling

If the  key is set for the scrolling mode (see par. 8.6), the operator can visualiza on the display the non displayed channel using the  key; eg. from the display page indicated below:

	I IN	0.478	mVL mV
O OUT		1088.4	°C

Press the  key to obtain the following indication:

	O OUT	1088.4	°C
P InP		147.80	PL mbar

If the  key is setting for the swapping mode (see par. 8.6), the operator can scroll between the channels by pressing the <Shift> +  keys.

NOTE: if the pressure module PM200 is not connected, a 'no module' message will be displayed.

H.10 Decimal point position

<←> and <→> keys allow the adjustment of the decimal point position for all Tc, Rtd and Hz ranges.

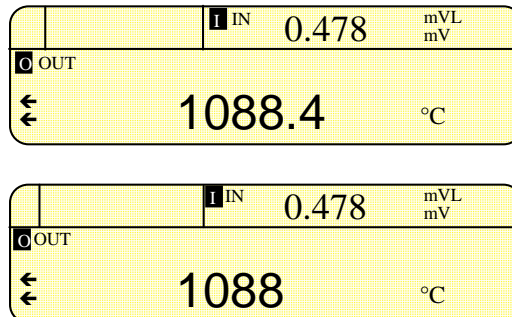

<←> and <→> keys also allow the measuring range change for mV, □ parameters (channel IN and OUT).

H.11 Average mode

The instrument is equipped with a special algorithm to allow measurements of an unstable input signal.

The weight of the average is programmable from 1 to 255 through the general configuration set-up procedure described in par. 8.7.

The appropriate setting should be based on a practical test taking into consideration that to an high programmed weight corresponds a high average effect.

H.12 Autorange

This function performs the autoranging for voltage, resistance and frequency measurements.

When the function is applicable press the <Menu> key to obtain 'Autorgn on' menù message.

Press <Autorgn> to toggle between -On- and -Off- state to activate/disable the function.

The message "ARN" will appear on the active slot if the function is abilitate.

H.13 Alarm function

Press the <Menu> key to obtain 'Set alm' menù message.

Press the <Set Alm> key to obtain the following indication :

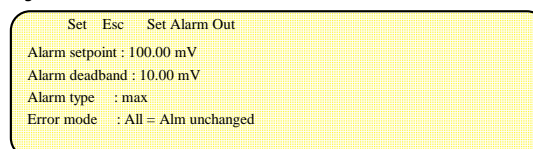

Alarm set point to set the alarm value

Alarm deadband to set the deadband value

Alarm type the type of the alarm (max or min)

Error mode **All** = the errors don't change the alarm state

Udr off = the Underrange error switches off the alarm ; the other errors switch it on

Udr on = the Underrange error switches on the alarm ; the other errors switch it off

All off = an error switches off the alarm state

All on = an error switches on the alarm state

- Press the <⦿> or <⦿> keys to select the required parameter to be adjusted;
- Press the <SET> key to enable the selected parameter adjustment;
- Press the <⦿> or <⦿> keys to select the required application configuration;
- Press the <ENTER> key to memory store the new selection;
- Press <Enter> to return to the menu.
- Press the <Alm Enbl> or <Alm Dsbl> to enable / disable the alarm function.

NOTE: On the measure slot display, an 'AL' message will appear when an alarm condition happen.

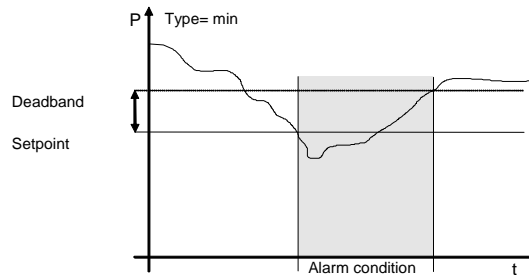
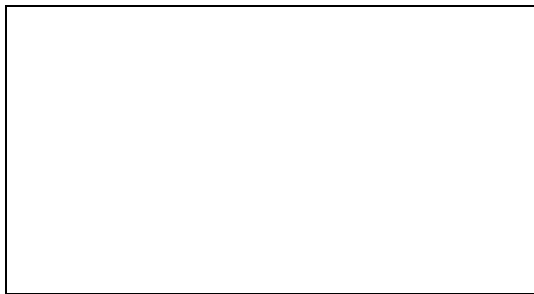

H.14 Parameter or sensor selection

To select the electrical parameter or the sensor required by the application, in any measuring or simulation mode, follow the procedure indicated below:

- Switch the instrument -ON-;
- Select the required -IN- or -OUT- mode using the <IN-OUT> key (pointer on the relevant mode)
- Press the <SELECT> key to obtain eg. the following menu page indicating all electrical ranges and thermoelectric sensors available for the measurement channel:

```

Pg Esc Set IN Type
Lin mVL mVH V mA k Hz pul Ω Ω
X X1 X2 X3 X4 X5
Tc J K T F R S B U L N E
Pt100 IEC OIML USLAB US SAMA JIS
Pt 200 500 1000 1000OIML
    
```

- A second menu page can be obtained using the <Pg> key.

```

Pg Esc Set IN Type
Lin mVL mVH V mA k Hz pul Ω Ω
X X1 X2 X3 X4 X5
Tc C G D TcX
Rtd Ni100 Ni120 Cu10 CU100 RtdX
    
```

Press <◀> <▶> or <◀◀> <▶▶> cursor keys to select the required signal or sensor;

Press the <ENTER> key to memory load the selection; the instrument will return to the previous operative mode with the new selected electrical signal or sensor;

By pressing the <ESC> key, instead of <ENTER>, the instrument will not acknowledge any variation and will return to the previous parameter or sensor.

Check a correct sensor selection using the following table:

IEC	$\alpha =$	0.00385
OIML	$\alpha =$	0.003910
USLAB	$\alpha =$	0.003926
US	$\alpha =$	0.003902
SAMA	$\alpha =$	0.003923
JIS	$\alpha =$	0.003916
Pt200, Pt500, Pt1000	$\alpha =$	0.00385
Pt1000 OIML	$\alpha =$	0.003910

H.15 Scale factor mode set-up

The "scale factor" mode is a method to read or to simulate electrical signal values in terms of engineering units eg. the below indicated procedure shows the use of the "scale factor" function for the calibration of a potentiometric recorder with a scale from 0.0 mbar to 400.0 mbar corresponding to an electrical linear input signal from 4 to 20 mA.

Five factors scale set-up are available both for INput and OUTput channels.

- Switch the instrument <ON>
- Select the required -IN- or -OUT- channel using the <IN-OUT> key
- Press the <SELECT> key to obtain the menu selection page

```

Pg Esc Set IN Type
Lin mVL mVH V mA Hz K Ω Ω
X X1 X2 X3 X4 X5
Tc J K T F R S B U L N E
Pt100 IEC OIML USLAB US SAMA JIS
Pt 200 500 1000 1000OIML
    
```

- Press the <◀> <▶> or <◀◀> <▶▶> cursor keys to select X1, X2,X5 program
- Press the <Set> key to enter the configuration page of the X1, X2,Xn program

```

Set Esc X1 Set
Type : mA Fun :linear
Low : 4.000 E.U. :mbar
High : 20.000 Prst :none
Low X: 0.0
High X: 400.0
    
```

Each parameter can be adjusted upon the application requirement.

- Press the <●> key to select the "Type" of parameter/range
- Press the <Set> key to abilitate the parameter/range selection
- Press the <●> or <●> key to select the required parameter/range among:
mVL • mVH • V • mA • Hz • Ω • kΩ • 0-100 mV • 0-10 V • 1-5 V • 0-20 mA • 4-20 mA • 0-500 Ω • 0-5 kΩ
- Press the <ENTER> key to acknowledge the new setting and to memory store the new selection
- Press <●> and <●> keys to select the other required parameters using the same procedure indicated above

- Low** set the low end of the electrical signal
- High** set the full scale value of the electrical signal
- Low X** set the low end value of the engineering scaled unit
- High X** set the full scale value of the engineering scaled unit
- Fun.** select the linear or square mode
- E.U.** select the scaled engineering unit
- Prst** select the preset for the scaling function (none, 0-100mV, 0-10V, 1-5V, 0-20mA, 4-20mA, 0-500Ω, 0-5kΩ)

- A typical numeric adjustment of a page is the following one:

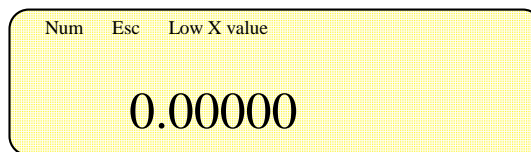

- Set the required value using the in-line single-digit mode or the direct numeric entry mode pressing the <Num> key to obtain the following indication:

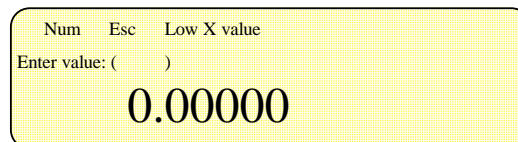

- In this case the required number and decimal point position must be entered using the numeric keyboard
- Press the <ENTER> key to acknowledge and to memory store the new setting
- Press <Esc> to return to the previous page or to reject the new set-up.
- The Engineering Unit (E.U.) can be set using a continuous scrolling, with the last four keys, of all characters indicated in the following table :

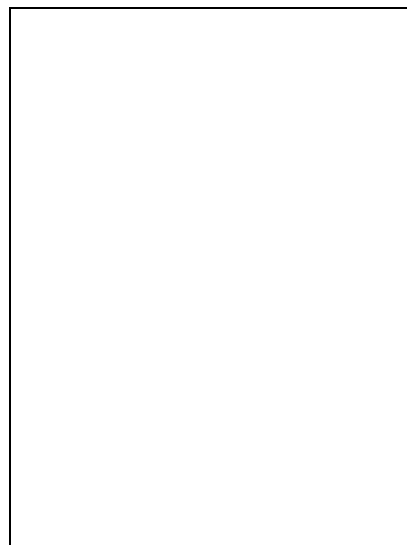

To obtain for example the following indication:

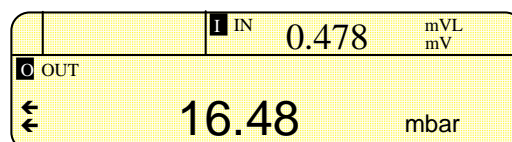

- After each adjustment press the <ENTER> key to memory store new data

H.16 Temperature parameters selection

This procedure is automatically enabled only when the relevant channel is programmed for thermocouple measurement or simulation.

- Press the <SELECT> key to enter the procedure obtaining the signal or sensor menu page e.g. as it follows:

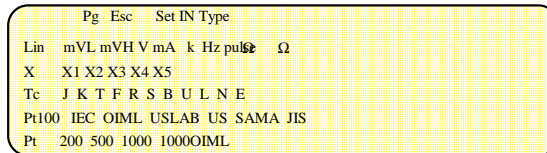

- Select the required thermocouple moving the cursor using the <●> or <○> or <←><→> keys.
- Press the <SET> key to obtain, for example, the following indication:

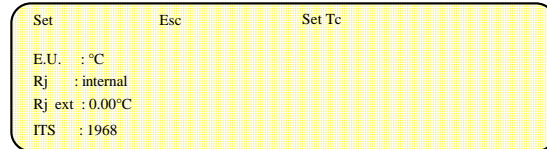

- E.U.** (engineering unit) = °C, °F or K
- Rj** (reference or cold junction) = **Internal** (automatic compensation at input terminals with a calibrated thin film Pt100)
external (adjustable from -50°C to +100°C)
remote (remote automatic compensation: requires the connection of an external Pt100)
- Rj est.** = adjustable from -50 to +100 °C
- ITS** (Internat. Temperature. Scale) = ITS1968 or ITS1990

Internal Rj mode use, as cold junction reference for temperature compensation, a resistance thermometer built-in the terminals. A special AOIP sas design allows a fast and accurate response.

External Rj mode allows to manually adjust the reference when it is not possible to compensate using the internal Rj or for Rj fault.

The remote Rj (reference or cold junction) compensation can be used either for accurate temperature readings using an external Pt 100 or to obtain a remote automatic Rj compensation when a number of thermocouples Rj are kept at constant temperature inside a temperature controlled cabinet.

A special feature is available in the instrument to correct the error of the external Pt 100 sensor and to obtain actual true accurate readings or Rj compensations.

When an external sensor is connected to the instrument the actual reading will be influenced by the accuracy of the instrument itself and by the inaccuracy of the sensor used.

Through the "Instrument Config" routine the operator can select and memory load the relevant "Probe err" specific to the resistance thermometer used.

"Probe err" is meant as the actual deviation entity (error) of the remote Pt 100 resistance thermometer at the required Rj temperature.

The deviation error value (in °C) can be obtained from the report of calibration of the remote RTD or through an in-situ comparison with a working standard element.

- Press the <●> or <○> keys to select the required parameter to be adjusted;
- Press the <SET> key to enable the selected parameter adjustment;
- Press the <●> and <○> keys to select the required application configuration;
- Press the <ENTER> key to memory store the new selection;
- Press the <ESC> key twice to return to the operative mode.

H.17 Rj fast mode selection

During normal -IN- or -OUT- operation with thermocouples the operator can directly change the Rj mode as it follows:

Press the <MENU> key and the required Rj mode:

- Rj int.**(ernal)
 - Rj ext.**(ernal)
 - Rj rem.**(ote)
- using the appropriate key.

This new Rj mode will be operative until a new change occurs and it will be also stored when the instrument is switched -Off-.

H.18 Resistance thermometer selection

When the measurement operative mode for resistance or resistance thermometer has been selected

- Press the <MENU> key to obtain the following indication:

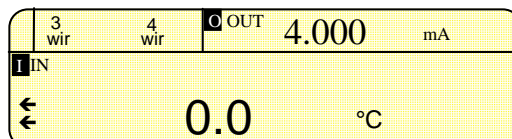

- Press the <3 wire> or the <4 wire> as required by the running application.
 The selected configuration will be memory stored until a new instruction is memory loaded.

H.19 IN-OUT data memory

The availability of a 20-step memory, both for INput and OUTput channels, represents an important feature either in simulation or in measurement modes.

In the measurement mode it can be useful to store twenty input values pertinent to special test conditions.

CALYS 1000/1200 OPERATION & APPLICATIONS

CALYS 1500

In the simulation mode, the permanent availability of twenty calibration values can be useful, eg. during the calibration of the scale of a recorder. To memory load each memory cell select first the appropriate operative mode and set the required value;

- Press <STO>, <0><9> to memory store data in the required memory position from 0 to 9;
- Press <STO>, <ENTER>, <0><9> to memory store data in the required memory position from 10 to 19;
- Press <RCL>, <0><9> to recall the memory stored value from 0 to 9;
- Press <RCL>, <ENTER>, <0><9> to recall the memory stored value from 10 to 19.

Memory stored data can be reviewed pressing the <STATUS> key to obtain the four pages headed - Memory Status -.

H.20 Autoscan program mode

The Autoscan program mode is based on twenty memory stored values that can be addressed, in sequence, to the output terminals.

With the instrument in a normal operative mode, press the <MENU> key to obtain the following indication:

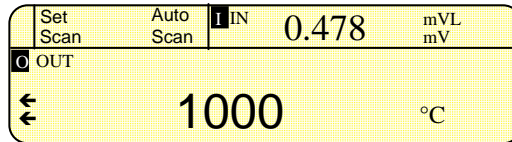

Press the <SET> key to define the Autoscan program obtaining the following indication:

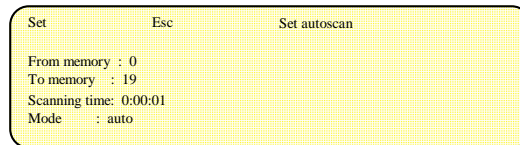

- Press <0> and <0> keys to select the parameter to be changed;
- Press the <SET> key to enable the single parameter adjustment;
- Press <0> and <0> keys to adjust the value or mode required;
- Press the <ENTER> key to memory store the new data;
- Press the <ESC> key to return to the normal operative mode;
- Press the <Autoscan> key to run the program;
- Press any key to stop the program when in - Auto mode -.

H.21 Ramp program mode

The instrument, through an easy to follow menu-driven set up, can be programmed to simulate a continuous or step output cycle.

By programming the incremental steps to their minimum value the step ramp can be assimilated to a continuous ramp.

First select the technical unit (°C, °F or K), the type of sensor/parameter and then follow the procedure indicated below.

- Press the <MENU> key to obtain the following indication:

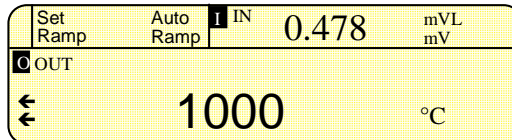

- Press the <Set Ramp> key
- Press the <Pg 0> key to select Autoramp 1 or Autoramp 2;
- Press the <0> or <0> key to select the parameter to be modified or adjusted;
- Press the <SET> key to enable the selected parameter adjustment;
- Press the <0> or <0> key to modify or adjust the parameter;
- Press the <ENTER> key to memory store each parameter (if modified).

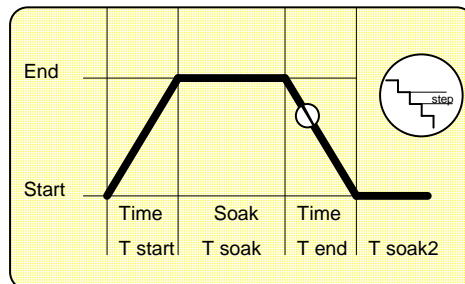
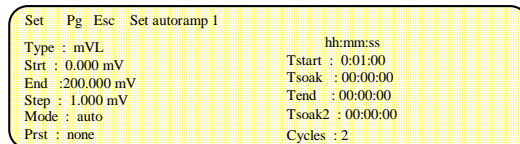

Pvst

For fast set up of the simulation cycle (S) the operator can select one of the following programs:

- none (must be selected when Start,End ,Step are not programmed and therefore the operator has selected and memory loaded free required values)
- 0 - 5 k Ω
- 0 - 500 Ω
- 4 - 20 mA
- 0 - 20 mA
- 1 - 5 V
- 0 - 10 V
- 0 - 100 mV

If one of the above is selected automatically each relevant datum will be shown in correspondence with Type,Start,End,Step parameters. The step value can be eventually reprogrammed if required.

Please note the following terminology classification:

Mode

Defines the autoramp mode of operation and can be programmed as it follows:

Manual

The output value will follow the overall programmed cycle with the step by step operator's instructions. Each time the <Autoramp > key is pressed the autoramp will move up (or down) one step value.

Auto

The instrument will generate the programmed number of cycles (eg n^o2 cycles)

At the end of the last cycle the instrument will stop simulation.

Continuous

The instrument will run a non limited number of cycles until the operator's "Stop" by using the <Autoramp> key.

H.22 Bargraph function

- Press the "Menu" key until you see the following menu:

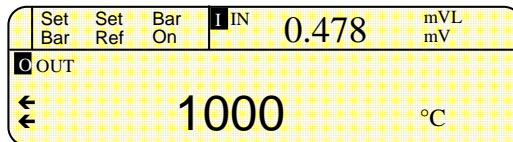

- Position the arrows by the <IN-OUT> key to select the desired channel (IN/OUT) you want to program the bargraph values.
- Press the <NUM> (SET BAR) key to obtain the following.

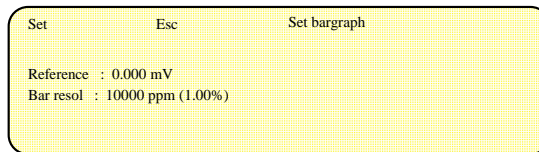

- Press the <NUM> (SET) key to set the reference value for the bargraph
- Press the <◀>key to select the following line and press <NUM> (SET) to set the desired bargraph resolution of every pixel.
- Press <ENTER> twice.

In order to set immediately a new reference value with the value actually displayed for the channel selected press the <LAMP> (SET REF)key. To display the bargraph press the <RAMP> (BAR-ON) key, the display will show:

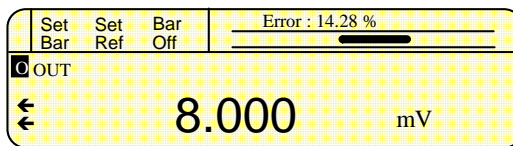

(with a reference of 7.000mV)

When you modify the output value the bargraph will show the new deviation value (error) in graphical format

H.23 Switch test routine

This function is useful to test two kinds of thermostat units, one with a built-in sensor and the other with an external sensor. When you activate this function the instrument will record the values in which the thermostat contact will change its state (i.e. when the contact closes and when the contact reopens).

To enable this function press the <MENU> key until you reach the following menu:

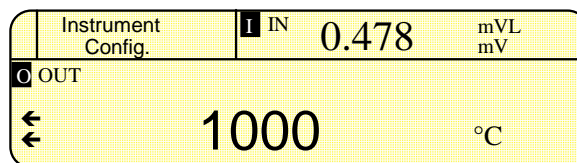

- Press one of the < Instrument Config > keys to obtain the following indication.

CALYS 1000/1200 OPERATION & APPLICATIONS

CALYS 1500

Set	Pag	Esc	Instrument config.
Date	: 28/02/93		ID name: 1
Time	: 18:12:26		Baud : 9600
Date fmt.	: dmy		Printer: disable
Cnt frct.:	none		
Cnt state:	n.open		

- Move the cursor with the <♦> key to select the "Cnt frct." line, press <NUM> (Set) and with <*> or <♦> keys select: "swtc OUT" or "swtc IN"; The choice depends on the thermostat type you want to test: "swtc OUT" is for thermostats with external sensor. The OUTPUT channel of the **Calys 1000/1200** and **Calys 1500** should be connected to the input terminal of the thermostat and the switch of the thermostat must be connected to a 25-pin connector located on the rear panel of the instrument.

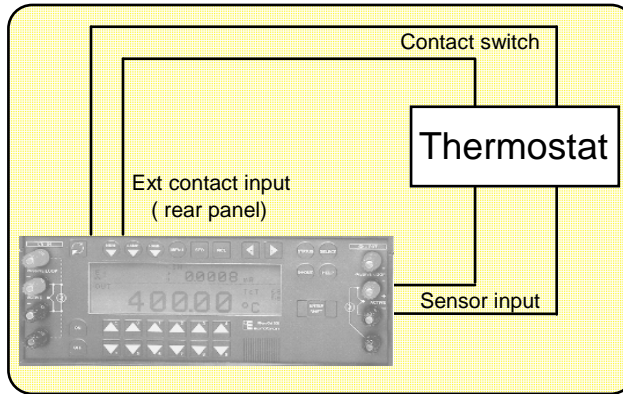

"switch IN" is for a thermostat with a built-in sensor and the INPUT channel of the **Calys 1000/1200** and **Calys 1500** must be connected to a sensor that will read the same temperature of the thermostat and the switch of the thermostat must be connected to a 25-pin connector located on the rear panel of the instrument.

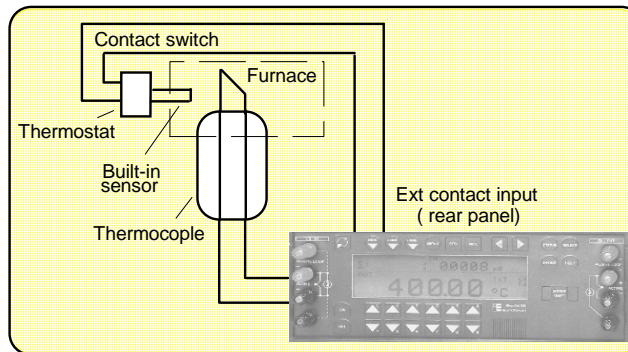

- Press the <ENTER> key.
- Move the cursor with the <♦> key to select the "Cnt state" line, press <NUM> (Set) and with <*> or <♦> keys select: "n. open" or "n. close" depending on the normal state of the thermostat switch.
- Press the <ENTER> key twice.
- Press the <IN-OUT> key to select the channel that must be used depending on the choice previously made (switch OUT or switch IN)
- Press the <MENU> key until you reach the following menu:

Swt	IN	0.478	mVL
On			mV
OUT			
←	1000		°C
←			

- Press the <RAMP> (Switch On) key to enable the switch test routine and initially the display will show:

Rst	Swt	***** °C
Swtc	Off	***** °C
OUT		
←	1000	°C
←		

When the condition of a change in the state of the thermostat switch is reached, the instrument will record the value in which the transition occurred. Moreover, when the thermostat switch returns to the original position the instrument will record the other value in which this new transition occurred.

Rst	Swt	↔	100.0 °C
Swtc	Off	↔	98.0 °C
OUT			
←	1000		°C
←			

In order to reset the recorded values for a new check press the <NUM> (Rst Swtc) key.

H.24 Offset mode set-up

This mode allows the setting of the offset value in measurement and simulation to cancel the influence of an unrequired portion of the signal.

- Select the required operative mode;
- Press the <MENU> key to obtain the following indication:

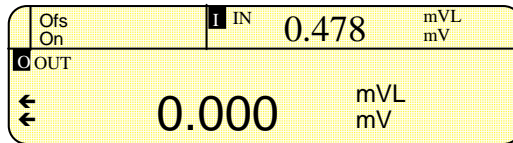

- For the simulation mode check the indication of the instrument under calibration.
- Adjust the calibrator output to match the required indication of the instrument under test.
- Press the <Ofs On> key to abilitate the offset mode set-up or the <Ofs Off> to disable the offset mode;

H.25 Frequency I/O

The instrument is equipped with an operative mode to allow frequency measurement and simulation.

The measurement mode requires an appropriate threshold set-up from 0 to 20 V and the simulation mode an output voltage level adjustment (0 to 20 V).

H.25.1 Frequency OUT

- Select the -Frequency Out- operative mode;
- Press the <MENU> key to obtain the following indication:

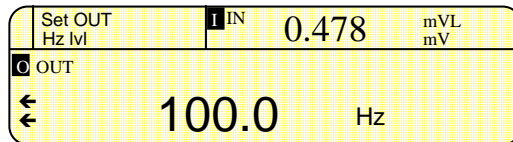

- Press the <Set OUT Hz lvl> key to enable the output pulse voltage level setting, obtaining the following indication:

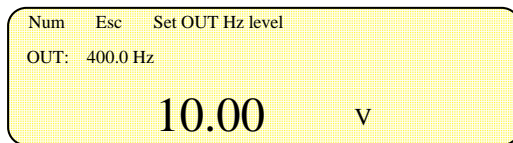

- Adjust the required output pulse voltage level value (range 0-20 V) with <0> and <1> keys or with the direct numeric entry through the <Num> key.
- Press the <ENTER> key to acknowledge the required value.
- The output pulse frequency can be programmed using <0> and <1> keys or the direct numeric entry mode with the <Num> key.
- The decimal point position can be set at 0.1 , 0.01 or 0.001 Hz using <<-> and <>-> keys.

H.25.2 Frequency IN

- Select the -Frequency In- operative mode;
- Press the <MENU> key to obtain the following indication:

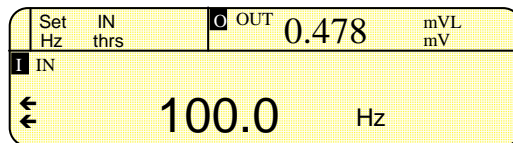

- Press the <Set IN Hz Thrs> to program the required threshold voltage level obtaining the following indication:

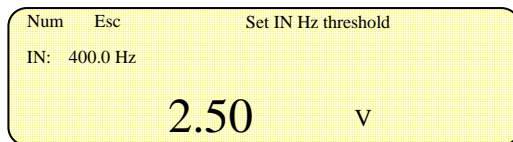

- Adjust the required threshold value (range 0-20 V) with <0> and <1> keys or with the direct numeric entry mode with the <Num> key.
- Press the <ENTER> key to acknowledge the required value.
- The measurement resolution can be set at 0.1 , 0.01 or 0.001 Hz using <<-> and <>-> keys.

H.26 Transmitter simulation

The instrument can be configured as a true universal programmable signal converter with IN/OUT insulation.

This operative mode can be used eg. as a temporary replacement of a transmitter.

- To enter this operative mode press the <MENU> key to obtain the following indication:

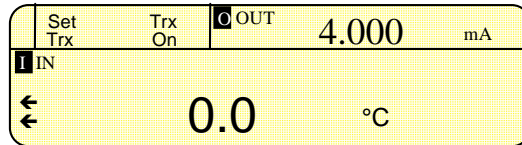

Press the **<Set Trx>** key to enable the relevant settings as indicated below:

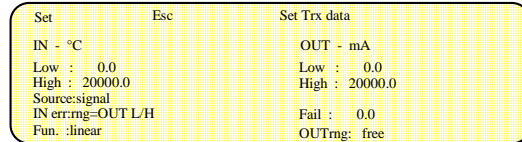

- Press **<0>** and **<0>** keys to select the required parameter.
- Press the **<Set>** key to allow value adjustment (OUTrange can be selected as free or limited to be programmed).
- Press the **<ENTER>** key to acknowledge the required value.
- Repeat the procedure to set other parameters.
- Press **<Enter>** to return to the signal converter menu.
- Press the **<Trx On>** key to abilitate the programmable signal converter operative mode.
- At the end of the application remember to switch the above operative mode off pressing the **<Trx off>** key.
- When the programmable signal converter operative mode is abilitated two additional key messages will appear on the left-top side of the display when the **<MENU>** key is pressed as it follows:

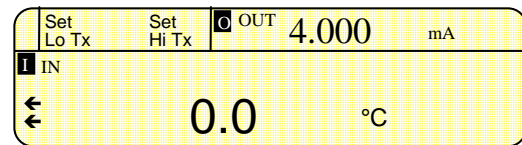

Press the **<Set LoTx>** or **<Set HiTx>** key to memory load both Low and High limit settings relevant to the actual measured and displayed value.

H.27 Graphic operative mode

This operative mode is available only when the instrument is equipped with data memory and real time clock (options A = 1 and 2).

To enter this operative mode press the **<MENU>** key to obtain the following indication:

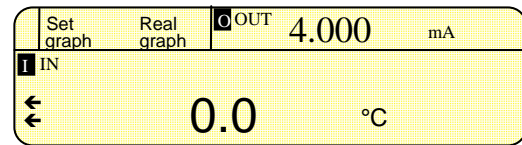

Press the **<Set graph>** key to enable the relevant settings as it is indicated below:

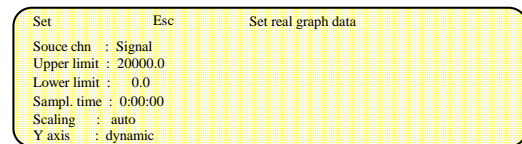

- Press **<0>** and **<0>** keys to select the required parameter.
- Press the **<Set>** key to allow value adjustments (Res. time is the time interval between two readings and Y axis can be setted as dynamic or fixed)).
- Press the **<ENTER>** key to acknowledge new values.
- Press the **<Real graph>** key to obtain the direct graphic profile of the input parameter against the actual time.

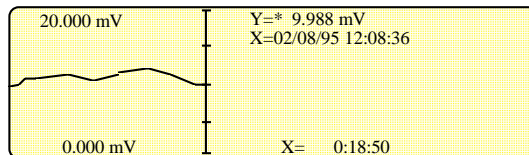

The upper time counter indicates the progressive time of acquisition.

The lower time indicates the total time of the acquisition.

Press the following keys for further instructions or to exit from the graph mode:



Return to the previous page

<STATUS>

Toggle numbers (enable graph only - press once more to cancel)

<RCL>

Toggle grid (press once more to cancel)

<STO>

Freeze graph (press once more to cancel)

<ENTER>+>><<>or<->

Move Y axis FAST or NORMAL to review and read the actual value for a required actual time

The above instructions can be obtained pressing the **<Help>** key while in the graph mode.

H.28 Pulse I/O

The instrument is equipped with an operative mode to allow pulse measurement and simulation.

The measurement mode requires an appropriate threshold set-up from 0 to 20 V and the simulation mode the set-up of the required output voltage level (from 0 to 20 V).

H.28.1 Pulse OUT

- Press the **<SELECT>** key to obtain the following indication:

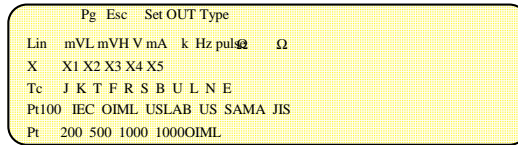

- Select the -pulse- operative mode and press the **<ENTER>** key to acknowledge the selection obtaining eg. the following indication:

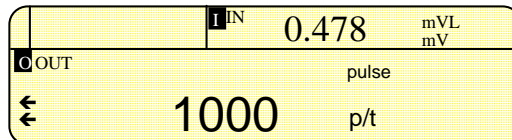

- Press the **<MENU>** key to obtain the following indication:

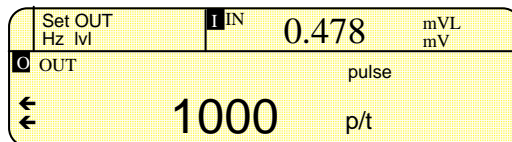

- Press **<Set OUT Hz lvl>** to enable the output pulse voltage level setting, obtaining the following indication:

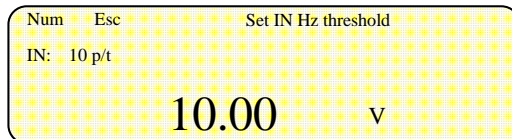

- Press the **<ENTER>** key to acknowledge the new setting.
- Press the **<MENU>** key to obtain the following indication:

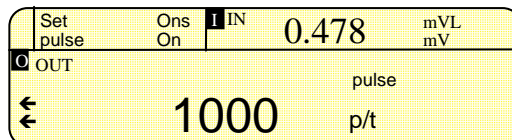

- Press the **<Set pulse>** key to obtain the following indication:

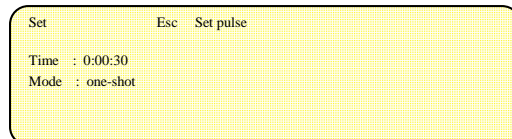

The "Time base" allows the setting of the pulse time base in hours, minutes and seconds. The mode can be selected as "continuous" or "one-shot".

- Press the **<ENTER>** key to acknowledge the new selection. The indication on the top-left of the display "Ons On or Off" will appear only if the one-shot operation has been selected. The instrument will return to the base indication as it follows:

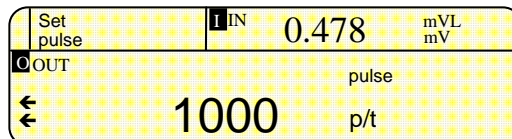

- The required pulse frequency can be set directly with **<0>** and **<9>** keys.
- If the "One-shot" was selected, to start the pulse train press the **<Ons On>** key. Remember that the technical unit can be p/s, p/m or p/h if respectively only seconds, minutes or hours are selected on the "Time base". If you select a number different from a single unit (1s, 1m, 1h) the indication will be p/t (pulse/time). The limits of the "Time base setting are 0:00:01 and 1:00:00 (from 1 second up to 1 hour)

H.28.2 Pulse frequency measurement and counter mode

- Press the **<SELECT>** key to obtain the following indication:



CALYS 1000/1200 OPERATION & APPLICATIONS

CALYS 1500

- Select the -pulse- operative mode and press the <ENTER> key to acknowledge the required operative mode obtaining eg. the following indication:

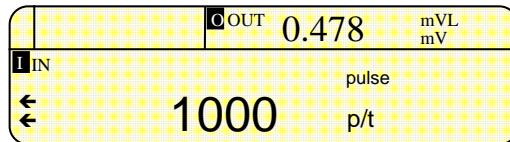

- Remember that the technical unit will be p/t (pulse/time) unless a single unit (1s, 1m, 1h) of the "Time base" is selected (indication P/s, p/m, P/h)
- To set the voltage level threshold press the <MENU> key and you will obtain the following indication:

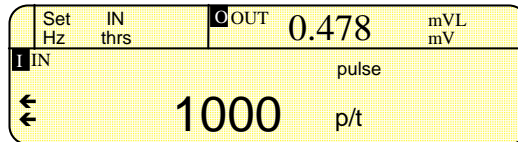

- Press the <Set IN Hz thrs> key to enter the set-up page of the threshold voltage level:

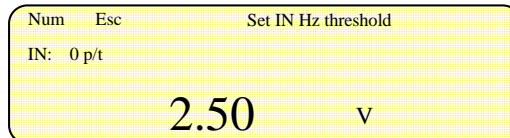

- Press the <ENTER> key to acknowledge the new setting and to return to the previous main page:

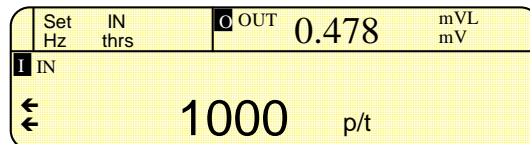

- Press the <MENU> page to reach the following page that enables the pulse setting:

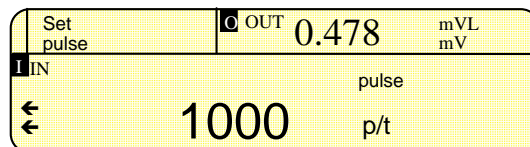

- Press the <Set pulse> key to obtain the following indication:

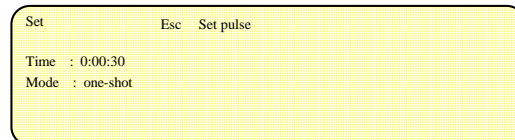

The "Time base" allows the setting of the pulse time base in hours, minutes and seconds. The limits are 0:00:00 and 1:00:00. The mode can be selected as "continuous" or "one shot". "One-shot" together with a "Time base" setting of 0:00:00 allows to work in a counter mode.

- Press the <ENTER> key to acknowledge the selection. The indication on the top-left of the display "Ons On or Off" will appear only when the one-shot operation has been selected. The instrument will return to the base indication:

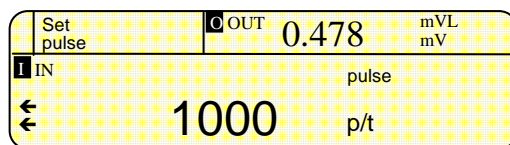

- In the counter mode (i.e. time base setting = 0:00:00) the <ON> key must be pressed to enable counting and to disable counting, re-press the same key.

H.29 Percentage and error display

The operator could require more convenient operations using percentage values for input and output instrument signals.

The above is specially required during calibration of eg. A temperature transmitter where the percentage error mode is useful.

The use of percent displays assumes, however, that the operator sets the range limits according to the input and output ranges of the instrument under test.

Calys 1000/1200 and **Calys 1500** is available with an auxiliary operative mode where the measured and simulated values can be shown in percentage of a programmable range with numerical form and bar graph indication.

To enter the percent mode procedure follows the procedure indicated below.

- Press the <ON> key to switch the instrument -On- and to obtain the main operative page eg. as it follows:

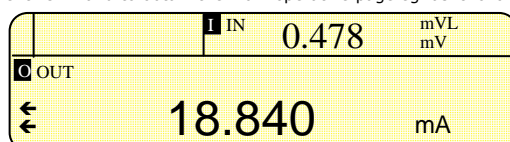

- Move the twin arrows to the channel that require to be abilitated for the percentage mode (in the above displayed page the twin arrows are placed in the "Out" channel).

Press several times the **<MENU>** key to obtain the following indication:

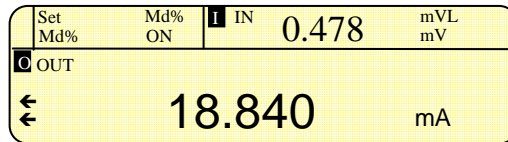

Press the **<Set Md%>** key to obtain the following page that allows the setting of percentage scaling as it follows (the example is relevant with the output channel).

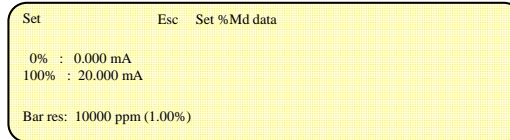

Bar graph resolution and percentage relation with zero and full scale of the range are the information that has to be loaded.

- Press **<0>** and **<0>** key to select the parameter to be programmed (or modified).
- Press the **<SET>** key to allow value adjustment.
- Press the **<Enter>** key to acknowledge the new data.

The instrument will return to the main page display. The same procedure has to be followed, moving first the twin arrows to the "In" channel, to obtain the following page:



The "Function" field allows to display the 0 and full scale % parameters with a linear or square relation according to the type of transmitter to be tested.

The **<% Err mod>** field allows to select the method for error calculation as "% of Full Scale" or "% of the Reading" when the display of the "% Md input" is enabled and when the display of "% Error" instead of "% of range" has been selected.

- Press the **<% Md On>** either on **IN**put or **OUT**put channel to obtain a bar graph display that indicates the percentage of the range actually measured or simulated.

The **OUT**put indication will be as it follows:

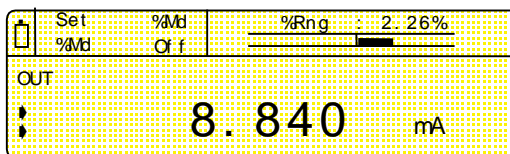

The **IN**put indication will be as it follows:

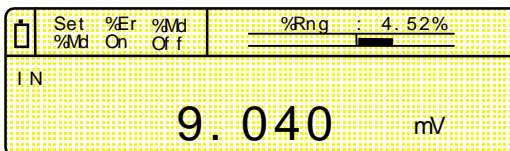

- To test the transmitter accuracy press the **<% Err On>** key to enable the computation and the display of the error in the **IN**put as a function of the simulated value referred to the **OUT**put value.

The "% Err" will be indicated as % of F.S. or % of Rdg according to the previous selection.

Example:

Setting a simulation output signal equivalent to 30% of the range a 30% of the input signal has to be found and measured.

Enabling the "% Err" the error shown by the transmitter at that specific test point will be displayed eg. as it follows:

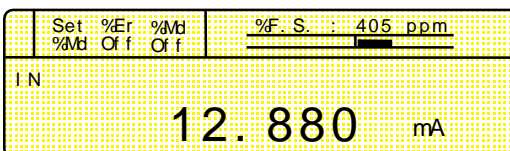

In the above page the error is indicated as "%of the full scale". If the error indication as "% of the reading" has been selected the displayed page will be the following:

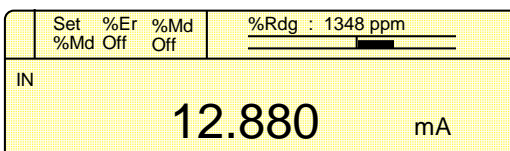

When the Percentage Mode has been enabled press the **<MENU>** page to obtain the following indication:

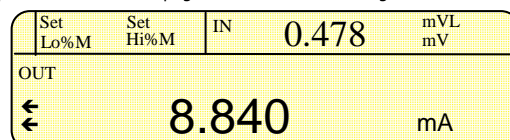

Press one of the above new keys to adjust automatically respectively the 0% value and the 100%value to the actually indicated **IN**put and **OUT**put signal values.

I. OPTIONS & ACCESSORIES

I.1 External printer

The instrument can be supplied, on request, with an external printer cat. BB490001 (Option Table C = 4).

The above printer is a 58 mm standard paper impact type printer to document measured or simulated values, memory stored data and to generate calibration report of instruments under test.

The printer is directly powered from **Calys 1000/1200** and **Calys 1500** through the back panel 9 pole connector and incorporates its own microprocessor for digital signal handling and character generation.

The printer module is supplied with cable and connector for a direct wiring to **Calys** with the following pinout:

- pin 1
- pin 2 5 V
- pin 3 Ground
- pin 4
- pin 5 RX
- pin 6 TX
- pin 7
- pin 8
- pin 9

As the communication between the instrument and the printer uses a dedicated protocol no other printer can be used instead of cat. BB490000.

I.1.1 General recommendation

- The impact type printer operation requires a high power therefore the battery discharge process is accelerated limiting the operation autonomy.
- When a battery operation print is planned provide for a full charge of the battery .
- A low level of the battery charge will cause the instrument to be automatically switched -Off- when the "Print" instruction is given.
- When high precision measurements or simulations are required wait minimum for 30 s after each printout.
- The display backlight will automatically switch -Off- at the printer start to reduce the overall power.
- When a "Print" instruction is given press any key to stop. The printed report will show the message "...cancelled" indicating the operator's stop instruction.
- Press the **<Adv On>** key for the chart advance and then the **<Adv Off>** key to stop.
- If the printer is not running check the cable and connector.
- If the "Busy" signal from the printer persists for 5 s or more the following message will be displayed:

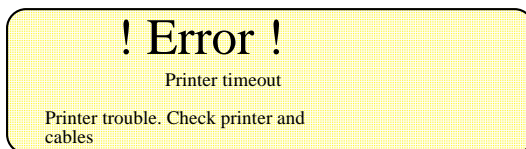

- Press any key to acknowledge the warning message

I.1.2 Printer operations: General

The printer operation can be enabled through the instrument general configuration procedure (see par.8.5)

With the instrument is operative in any mode press the **<MENU>** key several times to obtain the following indication:

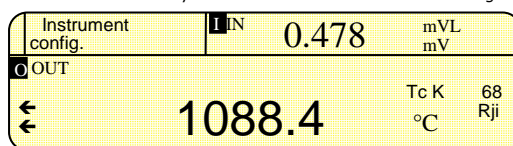

- Press one of the **< Instrument Config >** keys to obtain the following indication.

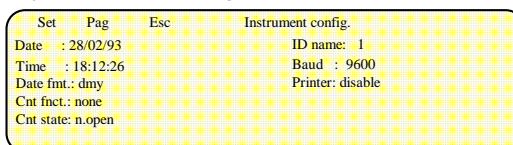

- Press the **<0>** or **<1>** key to select the "Printer" parameter
- Press the **<Esc>** key to enter the mode selection
- Press the **<0>** or **<1>** key to change from "Disable" to "Enable" or vice versa.
- Select "Disable" when the printer operation is not required or the printer not available.
- Press the **<ENTER>** key to acknowledge and memory store the printer mode
- Press the **<Esc>** key to return to the normal operative mode

I.1.3 Printer operation: Normal In-Out mode

- Select the required operative mode with eg the following indication:

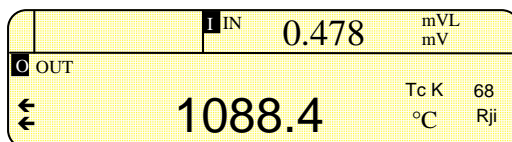

- Press the **<MENU>** key several times to obtain the following indication:

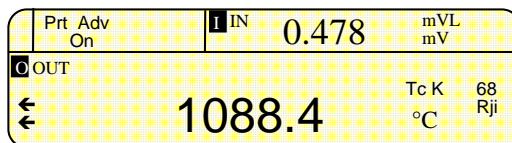

- Press the **<Adv On>** key to start the chart advance, if required.
- Press the **<Adv Off>** key to stop the chart advance
- The **<Set>** key is only used for special printout requirements not installed on standard instruments.
- Press the **<Prt>** key to obtain a printout as for the example shown below

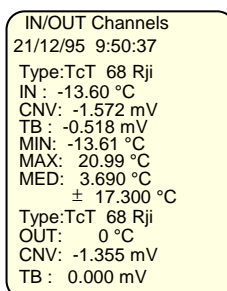

The time and date will be printed only if the real time clock, included in the option Table A =1, has been installed.
 Error messages, if there are any, will be printed as a last line in the "Out" mode or instead of the measured value in the "In" mode".

1.2 Data Logging function

This operative mode is enabled only when the battery back up option (see table A=1 or A=2 on par. 1.2) of the memory has been installed.
 The **Calys** indicator-simulator is equipped with an internal memory to perform a data acquisition function at programmable time intervals.
 The memory has a capacity of 1500 data record.
 Logged data are structured in groups, one single group contains the data measured and stored from each -RUN Log- and -End Log- operator's instructions.
 The operative mode of the Data Logging option is described in the following procedure.

- Switch the instrument **<ON>**
- Select the required operative mode (e.g. for temperature measurement with thermocouple type K - IPTS 68) as indicated at par. 8.4.2 and 8.4.3.

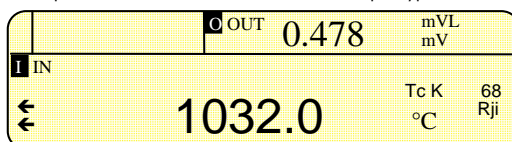

Remember that the opening of input terminals will cause a fluctuation of the reading up to "Underrange" or "Overrange" conditions.

- Press the **<MENU>** key several times to obtain the following indication:

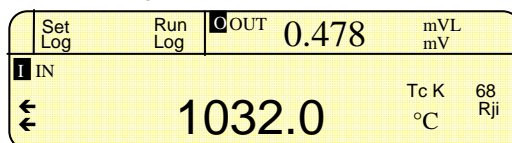

- Press the **<Set Log>** key to enter the page of logging parameters, obtaining the following indication:

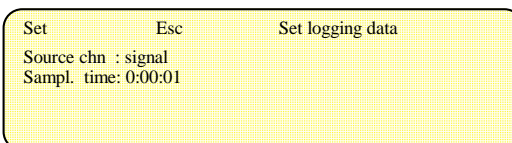

- Press **<@>** and **<0>** keys to select the required parameter to be modified (e.g. "Sampling time" = interval time between two subsequent data acquisitions).
- Press the **<Set>** key to enter the page of the parameter adjustment e.g. as it follows:

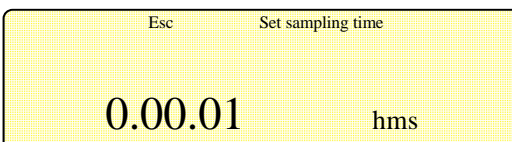

Any setting from 00 (h).00 (m).01 (s) to 12 (h).00 (m).00 (s) is accepted.

- Press the **<ENTER>** key to memory load the new sampling time or the **<Esc>** key to keep the previous setting.

The instrument will return to the indication:

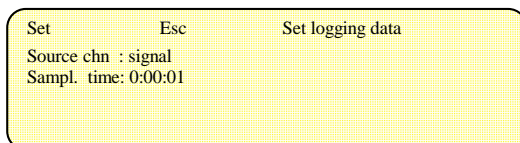

- Use the same procedure to set the additional parameters that are relevant to the graph operative mode.
- Press the **<Esc>** key twice to return to the normal operation page:

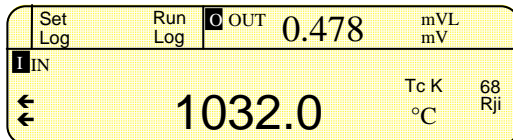

- Press the **<Run Log>** key to start the data acquisition program. The instrument will memory store the measured value at the end of each programmed time interval. The operative mode is announced with the "Log" message on the left of the display.

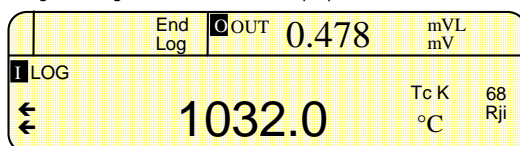

- Simultaneously with each data acquisition, instead of the "LOG" symbol, the indication "***" will appear, for few seconds, pointing out that the data acquisition is running. The data acquisition program ends automatically after 1500 data records or on the operator's instruction using the **<End Log>** key and the display will show the following indication:

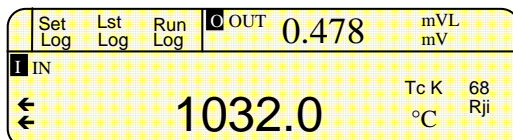

- The operator can review each memory cell content.
- Press the **<Lst Log>** key to review memory stored data with e.g. the following indication:

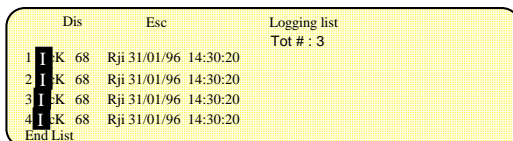

The above page shows that n.3 groups of data are memory stored

- To review the content of each group press the **<@>** or **<0>** key to select the required group
- Press the **<Dis>** key to obtain all data relevant to the selected group as indicated in the following figure.

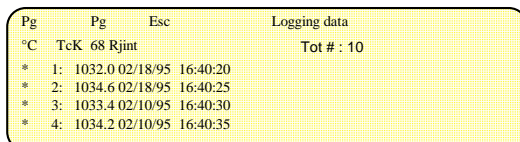

The above page indicates that 10 records were memory stored and that the sampling time was set at 5 s.

- The scanning can be per page using the **<Pg @>** or **<Pg 0>** key.
- Additional instructions can be obtained using the following keys:

- Gos** Go to start data (press first the **<Menu>** key to obtain this key indication)
- Got** Go to end data (press first the **<Menu>** key to obtain this key indication)
- Esc** Return to the previous page
- Got** To select the required memory stored data
- <ENTER>** Return to the previous page

When the above page is displayed the operator can obtain a full or partial graph following the procedure indicated below:

- Press the **<Menu>** key to obtain the required mode with the following indication:

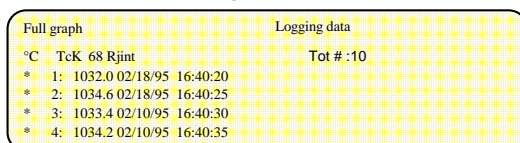

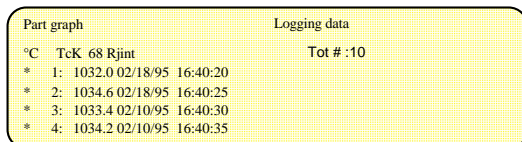

- Press the **<Full graph>** or **<Part. graph>** key to obtain e.g. the display of the graph of the memory stored values.

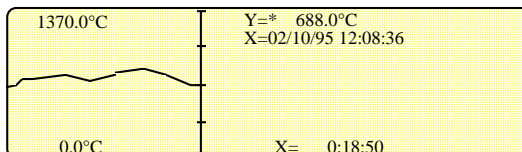

- Press the **<Return>** key to return to the page listing the stored data and the **<Esc>** key to return to the normal operation page.
- If you need to start a further data logging press the **<Run Log>** key obtaining the following warning message:

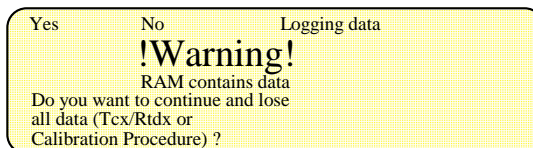

- Press the **<Yes>** key to cancel previous memory stored data and to start a new data logging or press the **<No>** key to cancel the previous instruction.

1.2.1 Printout of memory stored data

The availability of the optional external printer (option Table C =4) allows the preparation of a full report of all memory stored data. See general recommendation and printer "Enable" set-up at par. 8.7.

The procedure starts from the end of the data acquisition program with the following indication:

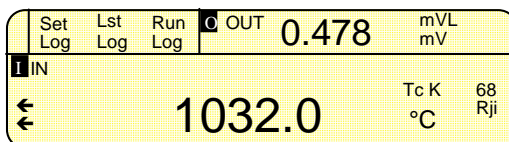

- Press the **<Lst Log>** key to display the memory stored data with e.g. the following indication:

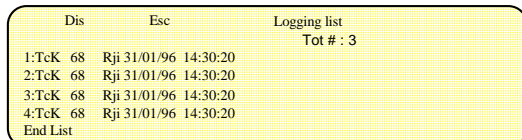

- When the printer is enabled (see instrument configuration procedure) a key **<Prt>** will be also displayed as it follows

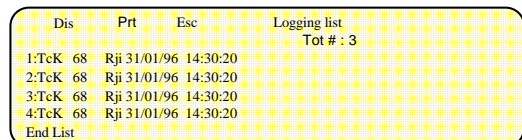

- Press the **<Prt>** key to obtain a printout of a memory stored group

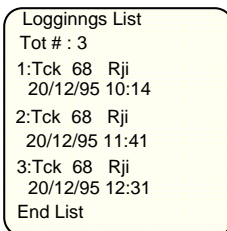

The same procedure should be used to select first required groups and then to obtain the group content printout as, for example, it is shown below:

```

Loggings Data
Type: tck 68 Rji
Tot#: 10
 1: -13.58 °C C
 20/12/95 12:31:32
 2: -13.58 °C C
 20/12/95 12:31:33
 3: -13.59 °C C
 20/12/95 12:31:34
 4: -13.59 °C C
 20/12/95 12:31:35
 5: -13.58 °C C
 20/12/95 12:31:36
 6: -13.59 °C C
 20/12/95 12:31:37
 7: -13.59 °C C
 20/12/95 12:31:38
 8: -13.59 °C C
 20/12/95 12:31:39
 9: -13.59 °C C
 20/12/95 12:31:40
10: -13.59 °C HC
 20/12/95 12:31:41
End Log

```

- If required press any key to stop the printer. A message "...cancelled" will appear on the report indicating a print stop requested by the operator. The example shows an acquisition at 1 minute intervals. The date and time will be printed only if the real time clock, included in the option Table A =1, is installed.

1.3 PM200 Pressure Module

Calys PM200 Pressure Module is designed to be connected to standard Calys 1000/1200 or Calys 1500 realizing a portable, compact, rugged and accurate multifunction calibration system (Calys PM200 System).

When the PM200 is correctly installed, the symbol "☐" shown on the main operative page.

The Pressure Module has been developed using a microcontroller technique to combine high flexibility of performances with a special procedure of calibration using computerized methods and storing into memory the relevant calibration data.

The relative / differential pressure measurement uses a temperature compensated silicon piezoresistive transducer individually characterized for linearity and temperature coefficient.

The individual sensor temperature / linearization matrix data are stored in a non-volatile EEPROM resident in the module.



In order to make the calibration activity easy the **PM200 System** can be specified with an internal single or twin pressure transducer up to 20 bar and, as an option, with a built-in hand pressure pump, a volume adjuster for fine control, a ventilation valve for pressure release and a pressure port.

As it is important that the maximum pressure for the device under test is not exceeded, a safety LIMITS function may be selected to automatically block the pumping action at the desired set pressure.

An external pressure transducer can be connected for pressure up to 700 bar.

The case made in Aluminium, has the front panel extremely rugged if you install the 20 bar built-in hand pressure pump.

The Pressure Module is powered by the Ni-Cd rechargeable batteries installed in the Calys .

Please, refer to the instructions manual for the operator's procedures.

J. DIGITAL INTERFACE

Calys is equipped with a digital interface at TTL level to allow communication with a Personal Computer. A normal or galvanic insulated TTL to RS232 adaptor is available on request. To set the communication parameters see the procedure in the par. 8.5.

J.1 Digital output wiring practice

The wiring to digital output signals is made through a mini DIN connector mounted on the lower end of the case.

The pertinent connections are indicated below :

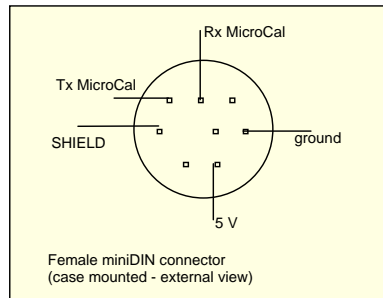

For easy interconnections a miniDIN connector with cable can be supplied on request.

The conductors color codes can change with different supplier; please check before using.

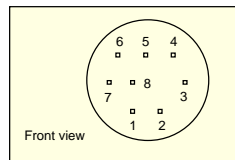

LINDY CINCH

pin 1 :	brown	black
pin 2 :	red	green
pin 3 :	green	blue
pin 4 :	gray	gray
pin 5 :	purple	yellow
pin 6 :	blue	white
pin 7 :	orange	red
pin 8 :	yellow	brown

J.1.1 TTL to RS232 adaptor

The TTL to RS232 adaptor consists of a cable to which are connected a male mini DIN connector (for the **Calys**) and a DB 25 connector, that contains the electrical circuitry (for the PC).

The basic circuit and connections are as follows:

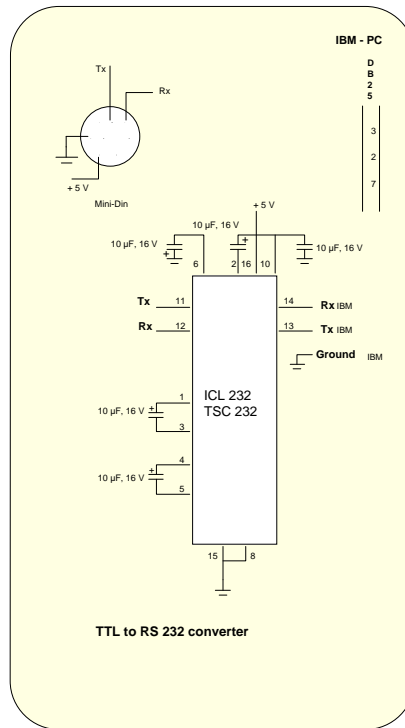

J.2 Communication protocol from Calys to a PC

The exchange of information when a **Calys** is connected with a PC is as it follows:

J.2.1 Computer data request from Calys

<u>Computer</u>		<u>Calys</u>	
Tx IDNAME	→	Rx IDNAME	Proceed if name acknowledged
Rx IDNAME	←	Tx IDNAME	If not, do not answer
Tx Instruction	→	Rx Instruction	
Rx Instruction	←	Tx Instruction	
Tx char	→	Rx char	
Rx DATA 1	←	Tx DATA 1	
Tx char	→	Rx char	
Rx DATA 2	←	Tx DATA 2	
Tx char	→	Rx char	
Rx DATA 3	←	Tx DATA 3	
Tx char	→	Rx char	
Rx DATA 4	←	Tx DATA 4	
Tx CHKSUM	→	Rx CHKSUM	
Rx CHKSUM	←	Tx CHKSUM	

IDNAME, Instruction, DATA 1, DATA 2, DATA 3, DATA 4 and CHKSUM are 8-bit decimal values.

Tx CHKSUM = DATA1 + DATA2 + DATA3 + DATA4 .AND. 7F

Rx CHKSUM (checksum) = DATA1 + DATA2 + DATA3 + DATA4 .AND. FF

The above is useful to verify correct received data.

The minimum time-out of **Calys** is 3 seconds.

Reading values

00 - Actual I/O type -----RX

- 0 I/O TYPE
- 1 I/O SUBTYPE
- 2 I/O FLAGS_IO (H)
- 3 I/O FLAGS_IO (L)

01 - Electrical Input value (invalue-final) -----RX

- 0 VALUE (HH) or 0x7f (denotes error)
- 1 VALUE (H) -
- 2 VALUE (L) -
- 3 VALUE (LL) or Error code

02 - Actual engineering unit -----RX

- 0 'X' (ASCII CODE)
- 1 'X' (ASCII CODE)

2 'X' (ASCII CODE)
 3 'X' (ASCII CODE)

05 - Output value (outvalue-final)-----RX

0 VALUE (HH)
 1 VALUE (H)
 2 VALUE (L)
 3 VALUE (LL)

06 - Pure Electrical Input value (invalue-pure/FATT)-----RX (Cnv)

0 VALUE (HH) or 0x7f (denotes error)
 1 VALUE (H) -
 2 VALUE (L) -
 3 VALUE (LL) or Error code

07 - Pure Output value (outvalue-pure/FATT) -----RX (Cnv)

0 VALUE (HH)
 1 VALUE (H)
 2 VALUE (L)
 3 VALUE (LL)

08 - Actual pure I/O type-----RX (Cnv)

0 I/O TYPE
 1 I/O FACTOR
 2 I/O FLAGS - IO (H)
 3 I/O FLAGS - TO (L)

09 - Actual pure engineering unit -----RX (Cnv)

0 'X' (ASCII CODE)
 1 'X' (ASCII CODE)
 2 'X' (ASCII CODE)
 3 'X' (ASCII CODE)

0A - Max Electrical input value (invalue_max) -----RX

0 VALUE (HH) or 0x7f (denotes error)
 1 VALUE (H) -
 2 VALUE (L) -
 3 VALUE (LL) or Error code

0B - Min Electrical input value (invalue_min)-----RX

0 VALUE (HH) or 0x7f (denotes error)
 1 VALUE (H) -
 2 VALUE (L) -
 3 VALUE (LL) or Error code

0C - Mean Electrical input value (invalue_med) -----RX

0 VALUE (HH) or 0x7f (denotes error)
 1 VALUE (H) -
 2 VALUE (L) -
 3 VALUE (LL) or Error code

0D - Deviation Electrical input value (invalue_scost)-----RX

0 VALUE (HH) or 0x7f (denotes error)
 1 VALUE (H) -
 2 VALUE (L) -
 3 VALUE (LL) or Error code

0E - Battery voltage-----RX

0
 1
 2 VBATT (H)
 3 VBATT (L)

10 - Flags 2-----RX

0
 1
 2 errout_global
 3 -

15 - Date-----RX

0 DAY
 1 MONTH
 2 YEAR
 3 -

16 - Time-----RX

- 0 HOURS
- 1 MINUTES
- 2 SECONDS
- 3 -

1A - Actual offset value (value_offset)-----RX

- 0 VALUE (HH)
- 1 VALUE (H)
- 2 VALUE (L)
- 3 VALUE (LL)

1C - Firmware version-----RX

- 0 'X' (ASCII CODE)
- 1 'X' (ASCII CODE)
- 2 'X' (ASCII CODE)
- 3 'X' (ASCII CODE)

1E - Actual internal Rj (rj_int - 2 decimals) -----RX

- 0 VALUE (HH) or 0x7f (denotes error)
- 1 VALUE (H) -
- 2 VALUE (L) -
- 3 VALUE (LL) or Error code

1F - Actual external Rj (rj_ext - 2 decimals)-----RX

- 0 VALUE (HH)
- 1 VALUE (H)
- 2 VALUE (L)
- 3 VALUE (LL)

20 - Remote Rj (rj_rem - 2 decimals)-----RX

- 0 VALUE (HH) or 0x7f (denotes error)
- 1 VALUE (H) -
- 2 VALUE (L) -
- 3 VALUE (LL) or Error code

21 - Pure linearization Input value (invalue_puretab/FATT) -----RX

- 0 VALUE (HH) or 0x7f (denotes error)
- 1 VALUE (H) -
- 2 VALUE (L) -
- 3 VALUE (LL) or Error code

22 - Pure linearization Output value (outvalue_puretab/FATT)-----RX

- 0 VALUE (HH)
- 1 VALUE (H)
- 2 VALUE (L)
- 3 VALUE (LL)

2F - Actual selection -----RX

- 0 Actual I/O channel (0 = OUTPUT - 1 = INPUT - 2=PRESSURE)
- 1 Actual slot display (0=Lower - 1=Upper)
- 2 I/O Channel for lower slot
- 3 I/O Channel for upper slot

30 - Serial number -----RX

- 0 VALUE (H)
- 1 VALUE (L)
- 2 -
- 3 -

31 - Actual decimals number -----RX

- 0 Displayed decimals
- 1 Pure signal decimals
- 2 -
- 3 -

32 - Calibrator ID (Calys 1000 = 9 - Calys 1200 = 11 - Calys 1500 = 14)-RX

- 0 Instrument ID
- 1 Instrument ID
- 2 Instrument ID
- 3 Instrument ID

33 - Pulse timebase OUT -----RX

- 0 HOURS
- 1 MINUTES
- 2 SECONDS
- 3 -

34 - Pulse mode OUT -----RX

- 0 flag_pulse (H)
- 1 flag_pulse (L)
- 2 -
- 3 'X' (ASCII CODE)

35 - Pulse timebase IN -----RX

- 0 HOURS
- 1 MINUTES
- 2 SECONDS
- 3 -

36 - Pulse mode IN -----RX

- 0 flag_pulse
- 1 flag_pulse (L)
- 2 -
- 3 -

3C - Firmware version-----RX

- 0 'X' (ASCII CODE)
- 1 'X' (ASCII CODE)
- 2 'X' (ASCII CODE)
- 3 'X' (ASCII CODE)

3D - Boot loader firmware version-----RX

- 0 'X' (ASCII CODE)
- 1 'X' (ASCII CODE)
- 2 'X' (ASCII CODE)
- 3 'X' (ASCII CODE)

40 - Flags X1 scaling OUT -----RX

- 0 flag_x (H)
- 1 flag_x (L)
- 2 SUBTYPE
- 3 -

41 - Flags X2 scaling OUT -----RX

- 0 flag_x (H)
- 1 flag_x (L)
- 2 SUBTYPE
- 3 -

42 - Flags X3 scaling OUT -----RX

- 0 flag_x (H)
- 1 flag_x (L)
- 2 SUBTYPE
- 3 -

43 - Flags X4 scaling OUT ----- RX

- 0 flag_x (H)
- 1 flag_x (L)
- 2 SUBTYPE
- 3 -

44 - Flags X5 scaling OUT ----- RX

- 0 flag_x (H)
- 1 flag_x (L)
- 2 SUBTYPE
- 3 -

45 - Engineering unit X1 scaling OUT ----- RX

- 0 'X' (ASCII CODE)
- 1 'X' (ASCII CODE)
- 2 'X' (ASCII CODE)
- 3 'X' (ASCII CODE)

46 - Engineering unit X2 scaling OUT -----RX

- 0 'X' (ASCII CODE)
- 1 'X' (ASCII CODE)
- 2 'X' (ASCII CODE)
- 3 'X' (ASCII CODE)

47 - Engineering unit X3 scaling OUT -----RX

- 0 'X' (ASCII CODE)
- 1 'X' (ASCII CODE)
- 2 'X' (ASCII CODE)

3 'X' (ASCII CODE)

48 - Engineering unit X4 scaling OUT -----RX

0 'X' (ASCII CODE)
1 'X' (ASCII CODE)
2 'X' (ASCII CODE)
3 'X' (ASCII CODE)

49 - Engineering unit X5 scaling OUT -----RX

0 'X' (ASCII CODE)
1 'X' (ASCII CODE)
2 'X' (ASCII CODE)
3 'X' (ASCII CODE)

4B – Auxiliary channel config -----RX

0 Ch setting (0=none 1=Humidity)
1 Ambient Temp. Technical Unit (0= °C 1= °F 2= K)
2 -
3 -

4C – Humidity measurements-----RX

0 VALUE (HH)
1 VALUE (H)
2 VALUE (L)
3 VALUE (LL)

4D – Ambient temperature measurements -----RX

0 VALUE (HH)
1 VALUE (H)
2 VALUE (L)
3 VALUE (LL)

50 - Flags X1 scaling IN -----RX

0 flags_x (H)
1 flags_x (L)
2 SUBTYPE
3 -

51 - Flags X2 scaling IN -----RX

0 flags_x (H)
1 flags_x (L)
2 SUBTYPE
3 -

52 - Flags X3 scaling IN -----RX

0 flags_x (H)
1 flags_x (L)
2 SUBTYPE
3 -

53 - Flags X4 scaling IN -----RX

0 flags_x (H)
1 flags_x (L)
2 SUBTYPE
3 -

54 - Flags X5 scaling IN -----RX

0 flags_x (H)
1 flags_x (L)
2 SUBTYPE
3 -

55 - Engineering unit X1 scaling IN -----RX

0 'X' (ASCII CODE)
1 'X' (ASCII CODE)
2 'X' (ASCII CODE)
3 'X' (ASCII CODE)

56 - Engineering unit X2 scaling IN -----RX

0 'X' (ASCII CODE)
1 'X' (ASCII CODE)
2 'X' (ASCII CODE)
3 'X' (ASCII CODE)

57 - Engineering unit X3 scaling IN -----RX

0 'X' (ASCII CODE)
1 'X' (ASCII CODE)
2 'X' (ASCII CODE)

3 'X' (ASCII CODE)

58 - Engineering unit X4 scaling IN -----RX

0 'X' (ASCII CODE)
 1 'X' (ASCII CODE)
 2 'X' (ASCII CODE)
 3 'X' (ASCII CODE)

59 - Engineering unit X5 scaling IN -----RX

0 'X' (ASCII CODE)
 1 'X' (ASCII CODE)
 2 'X' (ASCII CODE)
 3 'X' (ASCII CODE)

5A - Number of logging groups-----RX

0 VALUE (HH)
 1 VALUE (H)
 2 VALUE (L)
 3 VALUE (LL)

5B - Internal Rj OUT (rj_int - 2 decimals)-----RX

0 VALUE (HH) or 0x7f (denotes error)
 1 VALUE (H) -
 2 VALUE (L) -
 3 VALUE (LL) or Error code

5C - Internal Rj IN (rj_int - 2 decimals) -----RX

0 VALUE (HH) or 0x7f (denotes error)
 1 VALUE (H) -
 2 VALUE (L) -
 3 VALUE (LL) or Error code

61 - First recorded value of switch test routine----- RX

0 VALUE (HH) or 0x7f (denotes error)
 1 VALUE (H) -
 2 VALUE (L) -
 3 VALUE (LL) or Error code

62 - Second recorded value of switch test routine----- RX

0 VALUE (HH) or 0x7f (denotes error)
 1 VALUE (H) -
 2 VALUE (L) -
 3 VALUE (LL) or Error code

The Computer must combine HH - H - L - LL 8-bit wide each in a 32 bit long word value as it follows:

$$V32 = HH * 2^{24} + H * 2^{16} + L * 2^8 + LL$$

IF $V32 \geq 2^{31}$ then $V32 = V32 - 2^{32}$

or the H and L 8-bit wide each in a 16-bit word value as it follows:

$$V16 = H * 2^8 + L$$

IF $V16 \geq 2^{15}$ then $V16 = V16 - 2^{16}$

I/O TYPE or CNV TYPE	0	=	mVL
	1	=	mVH
	2	=	V
	3	=	mA
	4	=	Ω
	5	=	K Ω
	6	=	Hz
	7	=	pulse
	8	=	Tc
	9	=	Rtd
	10	=	X scaling

I/O SUBTYPE	(for I/O TYPE = 8)	(for I/O TYPE = 9)	(for I/O TYPE = 10)
	0 = Tc J	15 = Pt 100 IEC/DIN	0 = X1 scaling
	1 = Tc K	16 = Pt OIML	1 = X2 scaling
	2 = Tc T	17 = Pt USLAB	2 = X3 scaling
	3 = Tc F	13 = Pt US	3 = X4 scaling
	4 = Tc R	19 = Pt SAMA	4 = X5 scaling
	5 = Tc S	20 = Pt JIS	
	6 = Tc B	21 = Pt 200	
	7 = Tc U	22 = Pt 500	
	8 = Tc L	23 = Pt 1000	

9 = Tc N	24 = Pt 1000 OIML
10 = Tc E	25 = Ni 100
11 = Tc C	26 = Ni 120
12 = Tc G	27 = Cu 10
13 = Tc D	23 = Cu 100
14 = Tc X	29 = Rtd X

I/O FLAGS_IO

(FLAGS_IO).AND. 3	0 = Rj internal
	1 = Rj external
	2 = Rj remote
(FLAGS_IO).AND. 4	0 = ITS 68
	1 = ITS 90
(FLAGS_IO).AND. &18	0 = °C
	1 = °F
	2 = K
(FLAGS_IO).AND. &20	0 = 4 w (for □□ and k □ IN)
	1 = 3 w (for □ and k □ IN)
(FLAGS_IO).AND. &C0	0 = 0 dec Tc/Rtd
	1 = 1 dec Tc/Rtd
	2 = 2 dec Tc/Rtd
(FLAGS_IO).AND. &300	1 = 1 dec Hz
	2 = 2 dec Hz
	3 = 3 dec Hz

IF Measure (HH) or	0 = None
Inp CNV (HH) or	1 = Overrange
Max (HH) or	2 = Underrange
Min (HH) or	3 = Rj err. (high)
Med (HH) or	4 = Rj err. (low)
Dev (HH) or	5 = Calc. err.
Bar (HH) or	6 = *****
Rj int (HH) o	7 = Overflow
Rj rem (HH) =7 F (HEX) then the	8 = Underflow
corresponding value LL represent the error	9 = Measure waiting
code:	10 = Overvoltage
(Also for errout_global)	11 = Overcurrent
	14 = Zero err.
	15 = Frq. err.

"X" represents the ASCII code of the corresponding character, for the following characters, you must apply the conversion table, as shown:

Calys 1xxx	PC
128<----->	248
129<----->	234
130<----->	230
131<----->	24
132<----->	25
133<----->	224

(FLAGS_PULSE).AND. 1	0 = Continuous
	1 = One - shot
(FLAGS_X).AND. 7	(0 - 5) = x scaling decimals
(FLAGS_X).AND. 8	0 = Linear
	1 = Square
(FLAGS_X).AND. & 30	(1 - 3) = Pure signal decimals (for Hz)

V bat must be divided by 100 and represents the battery voltage with 2 decimals.

YEAR represents the year between 00-99.

Rj int, ext and rem represent the reference junction values in °C and must be divided by 100.

J.2.2 Computer data setting from PC to Calys

<u>Computer</u>		<u>Calys</u>	
Tx IDNAME	→	Rx IDNAME	Proceed if name acknowledged
Rx IDNAME	←	Tx IDNAME	If not, do not answer
Tx Instruction	→	Rx Instruction	
Rx Instruction	←	Tx Instruction	
Tx DATA 1	→	Rx DATA 1	
Rx char	←	Tx char	
Tx DATA 2	→	Rx DATA 2	
Rx char	←	Tx char	
Tx DATA 3	→	Rx DATA 3	
Rx char	←	Tx char	
Tx DATA 4	→	Rx DATA 4	
Rx char	←	Tx char	
Tx CHKSUM	→	Rx CHKSUM	
Rx CHKSUM	←	Tx CHKSUM	

IDNAME, Instruction, DATA 1, DATA 2, DATA 3, DATA 4 and CHKSUM are 8-bit decimal values

CHKSUM (checksum) = DATA1 + DATA2 + DATA3 + DATA4 .AND. 7F

The **Calys** receives and verifies the checksum, when not valid, it doesn't accept the data transmitted. The minimum time-out of the **Calys** is 3 seconds.

Writing values

80 - Actual I/O type -----TX

- 0 I/O TYPE
- 1 I/O SUBTYPE
- 2 I/O FLAGS_IO (H)
- 3 I/O FLAGS_IO (L)

81 - Output value (outvalue_final) -----TX

- 0 VALUE (HH)
- 1 VALUE (H)
- 2 VALUE (L)
- 3 VALUE (LL)

82 - Actual selection -----TX

- 0 Actual I/O slot display (0=Lower - 1=Upper)
- 1 -
- 2 -
- 3 -

83 - Date -----TX

- 0 DAY
- 1 MONTH
- 2 YEAR
- 3 -

84 - Time -----TX

- 0 HOURS
- 1 MINUTES
- 2 SECONDS
- 3 -

85 - Reset Max,Min and Input filter -----TX

- 0 -
- 1 -
- 2 -
- 3 -

87 - States control -----TX

- 0 Offset state (0=OFF - 1=ON - 2=ON on degrees for Tc /Rtd - 255 = Don't modify)
- 1 Avg. state (0=OFF - 1=ON - 255 = Don't modify)
- 2 Hold state (0=OFF - 1=ON - 255 = Don't modify)
- 3 Set LOIN-HIIN (1=SET LoIN - 1=Set HiIN - 255 = Don't modify)

88 - Filter weight -----TX

- 0 Filter weight (1-255)
- 1 -
- 2 -
- 3 -

89 - Function control -----TX

- 0 Output function (0=OFF Autoramp,Autoscan,Trx - 1=Start Autoscan - 2=Start Autoramp - 3=Start Trx 255 = Don't modify)
- 1 Input function (0=OFF Logging - 1=Start Logging - 255 = Don't modify)
- 2 I/O function (0 = OFF One-shot - 1 = ON One-shot - 255 = Don't modify)

3 -

8A - Store memory -----TX

- 0 Channel (0=OUT - 1=IN - 2=INP)
- 1 Memory number (0-19)
- 2 -
- 3 -

8B - Recall memory -----TX

- 0 Channel (0=OUT - 1=IN - 2=INP)
- 1 Memory number (0-19)
- 2 -
- 3 -

8E - Actual states control 2 -----TX

- 0 Autorange state (0=Off - 1=On - 255=no modify)
- 1 -
- 2 -
- 3 -

8F - Reset display error numbers -----TX

- 0 -
- 1 -
- 2 -
- 3 -

99 - Reset Output value -----TX

- 0 -
- 1 -
- 2 -
- 3 -

9A - Actual external Rj (rj_ext - 2 decimals) -----TX

- 0 VALUE (HH)
- 1 VALUE (H)
- 2 VALUE (L)
- 3 VALUE (LL)

9B - Pulse timebase OUT -----TX

- 0 HOURS
- 1 MINUTES
- 2 SECONDS
- 3 -

9C - Pulse mode OUT -----TX

- 0 flag_pulse (H)
- 1 flag_pulse (L)
- 2 -
- 3 -

9D - Pulse timebase IN -----TX

- 0 HOURS
- 1 MINUTES
- 2 SECONDS
- 3 -

9E - Pulse mode OUT -----TX

- 0 flag_pulse (H)
- 1 flag_pulse (L)
- 2 -
- 3 -

9F - Reset recorded values of switch test routine -----TX

- 0 -
- 1 -
- 2 -
- 3 -

C5 - Scroll / Swap selecting -----TX

- 0 Mode (0=Swap - 1=Scroll)
- 1 -
- 2 -
- 3 -

F2 - Reset instrument -----TX

- 0 -
- 1 -
- 2 -

3 -

F3 - Power off instrument -----TX

0 -
 1 -
 2 -
 3 -

F4 - Set baut rate by instrument table-----TX

0 VALUE(0=OFF,1=300,2=600,3=1200,4=2400,5=4800,6=9600,7=19200,8=38400,9=57600,10=115200)
 1 -
 2 -
 3 -

F5 - Set baut rate directly -----TX

0 VALUE (HH)
 1 VALUE (H)
 2 VALUE (L)
 3 VALUE (LL)

The computer must split a 32 bit long word into 4 bytes of 8 bit as it follows:

Bits 31-24 --> HH
 Bits 23-16 --> H
 Bits 15-8 --> L
 Bits 7-0 --> LL

IN/OUT selection 0 = Select Output channel
 1 = Select Input channel

OFFS 0 = Off Offset
 1 = On Offset
 2 = On on degrees
 255 = Don't modify

AVG 0 = Off
 1 = On
 255 = Don't modify

HOLD 0 = Off
 1 = On
 255 = Don't modify

XSCAL 0 = Set the Low value as the actual value on the display in INPUT mode
 1 = Set the High value as the actual value on the display in INPUT mode
 255 = Don't modify

FUN Output 0 = Off - Autoramp or Autoscan or TRX
 1 = Start Autoscan
 2 = Start Autoramp
 3 = Start TRX
 255 = Don't modify

FUN Input 0 = Off Logging
 1 = Start Logging
 255 = Don't modify

FUN I/O 0 = OFF One shot
 1 = ON One shot
 255 = Don't modify

MEM Represents the memory number between 0÷19

CHN 0 = Store to OUT memories
 1 = Store to IN memories

Actual Rj external the value must be multiplied by 100.

K. MAINTENANCE

The Calys portable calibrator has been factory tested and calibrated before shipment.

The calibration should be verified and re-adjusted if the instrument shows an error exceeding the declared specifications or when a critical active or passive component is replaced (either at component level or at board level)

AOIP sas will supply, on request, a technical reference manual, with all instructions and recommendations for service and calibration.

AOIP sas engineers will give prompt support for any request of assistance.

K.1 Faulty operating conditions

During the start up, measuring and simulation modes, faulty conditions of the instrument will be announced, with coded messages.

If the faulty condition is critical for the type of application, it is recommended to re-run the pertinent set up procedure.

All errors which cannot be recovered without the user's knowledge, result in some system action to inform the operator via a message, and where possible the system is restored.

Errors are classified thanks to the method by which they are handled. Recoverable errors report the error and then continue.

System errors which cannot be recovered cause the system to halt with a message displayed.

Restarting the instrument from -Power ON- may clear the error, but generally such messages are caused by hardware or software faults, which require the user's action.

After the start up diagnostic routine the presence of a fault in the system will be announced as it follows:

"Overrange"	In	Indicates an input signal higher than the acceptable level.
		Indicates an output signal setting higher than the acceptable level.
"Underrange"	In	Indicates a negative input signal lower than the acceptable.
		Indicates an output negative signal setting lower than the acceptable limit.
"Rj err. (high)"	In-Out	Indicates Rj int or remote temperature above the stated limit (+55°C or +100°C for remote)
"Rj err. (low)"	In-Out	Indicates Rj int or remote temperature below the stated limit (-10°C)
"Calc.err."	In-Out	Possible error during scale factor computation
"Overvoltage"	Out mA	Indicates a load resistance above the stated limits
"Overcurrent"	Other OUTs	Indicates a load resistance below the stated limits
"Overflow"	-----	Indicates a numerical "overflow" conditions
"Underflow"	-----	Indicates a numerical "underflow" conditions
"Frq.err."	In	Indicates that a too low or too high frequency is applied to the Input channel
"*****"	In	Indicates that the Max, Min or Med values are meaningless
(measure wait)	In	This error number indicates that the measured circuit has been temporary halted
"Zero err"	In	Indicates that the internal autozero is out of range.
"P.S fail"	In	Indicates that the external load is too low in current loop measurement.
"No Avail"	In-Out	Indicates that the selected user's linearization is not available
"No module"	In	Indicates that the Pressure module PM200 is not connected.

K.2 Protection fuses

The instrument is protected by self limiting circuits and resettable fuses as it follows:

IN Mode (mV, V)

The input circuit is intrinsically protected up to 50 V (Tc and mV ranges)..

IN Mode (mA)

The input circuit is protected by the F5 (In) resettable fuse installed on the main board of the instrument.

IN Mode (Rtd)

The input circuit is intrinsically protected up to 5 V and by the two resettable fuses F4 and F6.

OUT Mode (V, mV)

The simulation circuit is protected by a current limiting device set at 2 mA.

In case of overcurrent, due to wrong external connections, the simulation circuit is also protected by the F2(Out) slow blow 100 mA fuse mounted on the main board.

OUT Mode (mA)

The simulation circuit is intrinsically protected by the impedance of the circuit and with the two resettable fuses F2 and F3.

OUT Mode (Rtd)

The simulation circuit is protected by a current limiting device up to 5 V.

In case of overvoltage, due to wrong external connections, the simulation circuit is also protected by F2(Out).

The protection is effective between terminals A and B or A and C or B and D.

Auxiliary power supply (In) (for mA)

The auxiliary power supply output is protected for a reverse voltage of 100 Vdc .

This circuit is also protected with a combination of a current limiting resettable fuse (F4).

Auxiliary power supply (Out) (for mA)

The auxiliary power supply output is protected from a reverse voltage of 100 Vdc .

This circuit is also protected by a combination of a current limiting resettable fuse (F3).

K.3 Safety recommendations

Primary elements (i.e. thermocouples, resistance thermometers, etc.) are normally linked to electrical potentials equal or near to the ground potential. However, in some applications, there may be present a common mode voltage to earth.

Check for voltage between input terminals and the ground, as this voltage can be transmitted to other devices connected to the calibrator.

K.4 Storage

If the instrument has been left unused for a long time, it is recommended to remove its batteries.

Store the instrument in the original package, at a temperature from -30°C to +60°C, with R.H. less than 90%.

If the instrument has been unused for a month check the battery voltage, and charge Ni-Cd batteries for at least 4 hours.

Returning

If the unit is to be returned, it is preferable to use the original packaging and state as clearly as possible, in a note attached to the unit, the reasons for its return.

AOIP SAS Rue Dupont Gragé F-14600 Honfleur
From France : 01.69.02.89.30 From your country : +33(1) 69.02.89.50
Fax : +33(1) 69 02 89 60 Email : sav@aoip.com



Warning

The packaging supplied with the calibrator can withstand a maximum pressure of 20 bar at 21°C (290 psi at 70°F). Subjecting the package to a higher pressure risks damaging the unit.

K.5 EMC Conformity

The Pressure Module case is made in aluminium to fulfil the provision of the directive 89/336/CEE Electromagnetic Compatibility.

The following page is a copy of the EMC declaration of conformity.

Declaration of Conformity



AOIP SAS
ZAC DE L'ORME POMPONNE
50-52 Avenue PAUL LANGEVIN
F-91130 RIS-ORANGIS

From France :

▶ N°Azur 0 810 10 2647
PREMIER APPEL LOCAL

01 69.02.89.88

From your country :
+33(1) 69.02.89.00

Fax : +33(1) 69 02 89 70





234 Old Weaverville Road • Asheville • North Carolina • 28804
Phone: (828) 658-3131 • Toll Free: (800) 421-2853 •
Fax: (828) 658-0728 • Email: info@palmerwahl.com
www.palmerwahl.com