

Rosemount™ 2110 Level Switch

Vibrating Fork

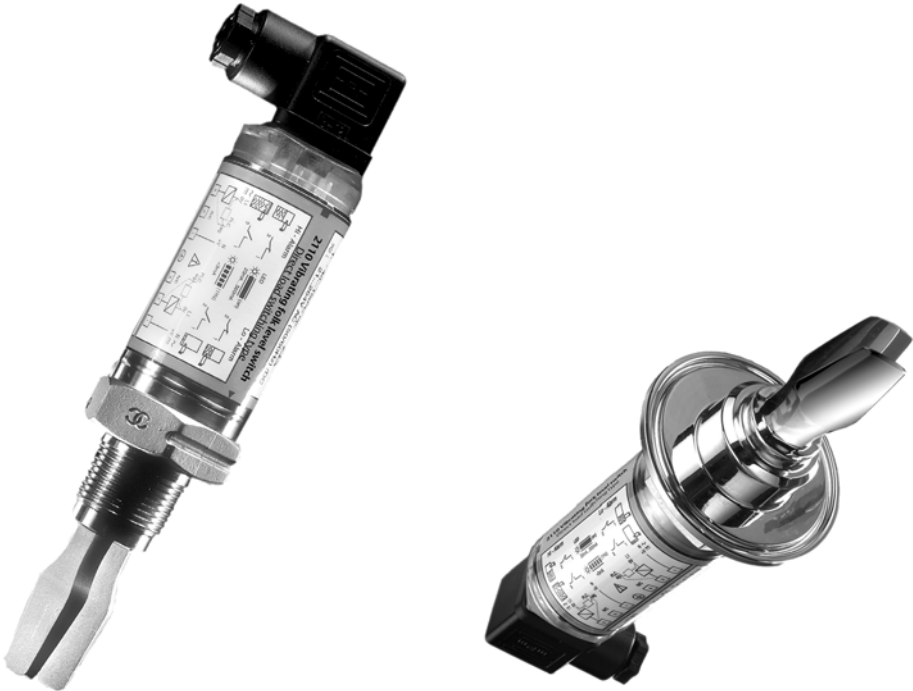

Rosemount™ 2110 Level Switch

Vibrating Fork

⚠ WARNING

Read this manual before working with the product. For personal and system safety, and for optimum product performance, make sure you thoroughly understand the contents before installing, using, or maintaining this product.

For technical assistance, contacts are listed below:

Customer Central

Technical support, quoting, and order-related questions.

United States - 1-800-999-9307 (7:00 am to 7:00 pm CST)

Asia Pacific- 65 777 8211

Europe/ Middle East/ Africa - 49 (8153) 9390

North American Response Center

Equipment service needs.

1-800-654-7768 (24 hours—includes Canada)

Outside of these areas, contact your local Emerson™ representative.

⚠ CAUTION

The products described in this document are NOT designed for nuclear-qualified applications. Using non-nuclear qualified products in applications that require nuclear-qualified hardware or products may cause inaccurate readings.

For information on Rosemount nuclear-qualified products, contact your local Emerson Sales Representative.

Contents

Section 1: Introduction

1.1 Safety messages	1
1.2 Manual overview	2
1.3 Introduction to the Rosemount™ 2110	2
1.3.1 Features list	2
1.3.2 Measurement principle	3
1.3.3 Short fork technology	3
1.3.4 Special features	4
1.4 Product recycling and disposal	5

Section 2: Installation

2.1 Safety messages	7
2.2 Considerations before installation	8
2.2.1 Environmental considerations	8
2.2.2 Application considerations	8
2.2.3 Installation considerations	10
2.3 Installation procedures	13
2.3.1 Process connection seals	13
2.3.2 Correct fork alignment	14
2.3.3 Mounting the threaded versions	15
2.3.4 Mounting the Tri Clamp versions	17
2.4 Electrical installation	18
2.4.1 Prepare the electrical connections	18
2.4.2 Wiring	21
2.5 LED Indication	24

Section 3: Troubleshooting

3.1 Magnetic test point	25
3.2 Inspection	25
3.3 Maintenance	26
3.4 Troubleshooting	26
3.5 Spare parts	26
3.6 Service support	27

Appendix A: Reference Data

A.1 Product Certifications 29
A.2 Ordering Information, Specifications, and Drawings 29

Section 1 Introduction

1.1 Safety messages

Procedures and instructions in this manual may require special precautions to ensure the safety of the personnel performing the operations. Information that raises potential safety issues is indicated by a caution symbol (⚠). The external hot surface symbol (🔥) is used when a surface is hot and care must be taken to avoid possible burns. If there is a risk of an electrical shock, the (⚡) symbol is used. Refer to the safety messages listed at the beginning of each section before performing an operation preceded by this symbol.

⚠ CAUTION

Failure to follow these installation guidelines could result in death or serious injury.

- Protection afforded by compliance to EN61010-1 may be impaired if the equipment is not used as specified.
- The Rosemount™ 2110 must be installed, connected, commissioned, operated, and maintained by suitably qualified personnel only, observing any national and local requirements that may apply.
- Ensure the wiring is suitable for the electrical current and the insulation is suitable for the voltage, temperature, and environment.
- Use the equipment only as specified in this manual. Failure to do so may impair the protection provided by the equipment.
- Any substitution of non-recognized parts may jeopardize safety and is under no circumstances allowed.
- Review the product approvals for any restrictions associated with an installation. See “Reference Data” on page 29 for where to find the latest information.
- Verify that the operating environment of the level switch is not a hazardous area location.

External surface may be hot.

- Care must be taken to avoid possible burns.

Process leaks could result in death or serious injury.

- Install and tighten process connectors before applying pressure.
- Do not attempt to loosen or remove process connectors while the Rosemount 2110 is in service.

Electrical shock could cause death or serious injury.

- If the liquid level switch is installed in a high voltage environment and a fault condition or installation error occurs, high voltage may be present on leads and terminals.
- Use extreme caution when making contact with the leads and terminals.
- Make sure that power to the Rosemount 2110 is off while making connections.

1.2 Manual overview

This manual provides information on installing, operating, and maintaining all versions of the Rosemount 2110 Vibrating Fork Liquid Level Switch (“level switch”).

[Section 2: Installation](#) provides instruction on mechanical and electrical installation procedures.

[Section 3: Troubleshooting](#) contains instructions about using the magnetic test point, as well as inspection, basic maintenance, and troubleshooting information.

[Appendix A: Reference Data](#) contains instructions on how to find the latest product certifications, specifications, dimension drawings, and ordering information on the Emerson.com/Rosemount site.

Note

Refer to the Rosemount 2110 [Quick Start Guide](#) for instruction on hygienic installation of a level switch with a 51 mm Tri Clamp fitting.

1.3 Introduction to the Rosemount 2110

The Rosemount 2110 is a liquid point level switch based on the vibrating short fork technology. It is a compact switch with a rugged stainless steel body and forks for use in a wide range of liquid applications. For most liquids, including coating and aerated liquids and slurries, the function is virtually unaffected by flow, turbulence, bubbles, foam, vibration, or changing liquid properties.

1.3.1 Features list

Features include:

- Stainless steel housing and plug/socket connection for fast-fit, high-volume users.
- Compact and lightweight design for side, top, or bottom mounting.
- The industry standard DIN 43650 plug/socket is used for a fast connection. The polarity insensitivity and short circuit protection make electrical hook-up safe and easy.
- Designed for operation in temperatures from –40 to 302 °F (–40 to 150 °C).
- Economical 3/4- or 1-in. threaded process connections for mounting in pipes or tanks, or Tri Clamp mounting for food industry.
- Direct load switching (suits all supplies) or PNP output for direct interface to PLCs.
- “Fast drip” fork design gives quick response time.
- ‘Heartbeat’ LED gives an instant visual indication that the level switch is operational.
- Optimized fork shape for hand polishing to meet hygienic requirements.
- No moving parts or crevices (means virtually no maintenance).
- Magnetic test point for easy functional test.

This combination of features makes the Rosemount 2110 an ideal choice for a wide variety of applications. The level switch is for use in non-hazardous (safe) area installations only.

See [Figure 1-1 on page 3](#) for application examples.

Figure 1-1. Rosemount 2110 Features

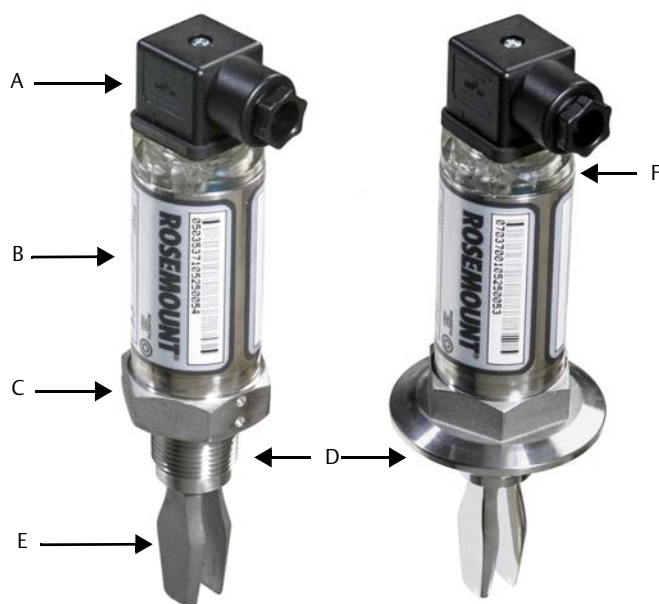

- A. Industry standard DIN 43650 plug/socket
- B. Stainless steel housing with magnetic test point
- C. Hexagonal nut for tightening a threaded process connection, and for fork orientation
- D. Threaded and Tri Clamp process connection options
- E. 'Fast drip' fork design
- F. Visible 'heartbeat' LED

1.3.2 Measurement principle

The Rosemount 2110 is designed to use the principle of a tuning fork. A piezo-electric crystal oscillates the forks at their natural frequency. Changes to this frequency are continuously monitored. The frequency of the vibrating fork sensor changes depending on the medium in which it is immersed. The denser the liquid, the lower the frequency.

When used as a low level alarm, the liquid in the tank or pipe drains down past the fork, causing a change of natural frequency that is detected by the electronics and switches the output state.

When the Rosemount 2110 is used as a high level alarm, the liquid rises in the tank or pipe making contact with the fork and causing the output state to switch.

1.3.3 Short fork technology

The natural frequency ($\sim 1300\text{Hz}$) of the fork avoids interference from plant vibration which may cause false switching. It also gives short fork length for minimal intrusion into vessel and pipe. By using Short Fork Technology and through extensive research, Emerson™ has maximized the design and operational effectiveness of the Rosemount 2110 making it suitable for practically all liquids, including coating liquids, aerated liquids, and slurries.

1.3.4 Special features

Fork design

The “fast drip” fork design draws liquid away from the fork tips when mounted horizontally, and together with a short switching delay, allows the Rosemount 2110 to react quickly and with greater sensitivity to density variations.



Heartbeat LED

The Rosemount 2110 has a ‘heartbeat’ LED indicating it is operating, and can be seen at all times. The LED flashes when the switch output is ‘off’ and is constantly lit when ‘on’.

Magnetic test point

A magnetic test-point is located on the side of the housing, allowing the user to perform a functional test of the Rosemount 2110 and the system connected to it. Holding a magnet to the test-point causes the output to change state.

Figure 1-2. Rosemount 2110 Application Examples

	<p>Overfill protection Spillage caused by overfilling can be hazardous to people and the environment, resulting in lost product and potentially high clean up costs.</p>
	<p>High and low level alarm Maximum and minimum level detection in tanks containing different types of liquids are ideal applications. The Rosemount 2110 operates continuously across the process temperature range of -40 to 302 °F (-40 to 150 °C) and operating pressures of up to 1450 psig (100 barg), making it perfect for use as a high or low level alarm. It is common practice to have an independent high level alarm switch as a backup to an installed level device in case of primary failure.</p>

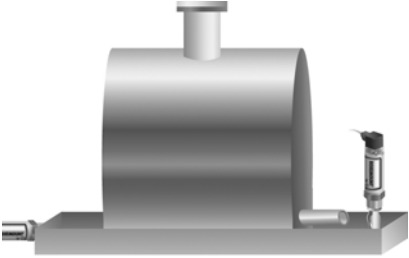
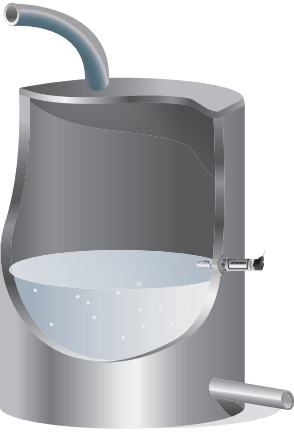
	<p>Pump protection or empty pipe detection Short forks require minimum intrusion wetside and allow simple low cost installation at any angle into pipes or vessels. Because the Rosemount 2110 projects only 2-in. (50 mm) (depending on connection type), it can be installed in small diameter pipes. By selecting the option of direct load switching electronics, it is ideal for reliable pump control and can be used to protect against pumps running dry.</p> <p>Pump control Many processes have batching and header tanks with the need to control a pump to maintain levels between set points. The Rosemount 2110 is ideal for these situations, since these tanks are often manufactured from thin wall materials and cannot support the weight of heavy instrumentation.</p>
	<p>Leak detection Flanges, gaskets, seals, corrosive liquids all have the potential to leak at the most inconvenient times. Many users site tanks and vessels above trays, or in containments to prevent any liquids from escaping. A level switch can quickly and accurately detect any leakage, thereby eliminating costs.</p>
	<p>Hygienic applications The highly polished fork option provides a surface finish (Ra) better than 0.8 μm. The Rosemount 2110 meets the principle design criteria of the most stringent hygienic requirements used in food and beverage, and pharmaceutical applications. Manufactured in stainless steel, it is robust enough to easily withstand steam cleaning (CIP) routines at temperatures up to 302 °F (150 °C).</p>

1.4 Product recycling and disposal

Recycling of equipment and packaging should be taken into consideration. The product and packaging should be disposed of in accordance with local and national legislation.

Section 2 Installation

Safety messages	page 7
Considerations before installation	page 8
Installation procedures	page 13
Electrical installation	page 18
LED Indication	page 24

2.1 Safety messages

▲ WARNING

Failure to follow these installation guidelines could result in death or serious injury.

- The Rosemount™ 2110 Level Switch (“level switch”) must be installed, connected, commissioned, operated, and maintained by suitably qualified personnel only, observing any national and local requirements that may apply.
- Ensure the wiring is suitable for the electrical current and the insulation is suitable for the voltage, temperature, and environment.
- Use the equipment only as specified in this manual. Failure to do so may impair the protection provided by the equipment.
- Any substitution of non-recognized parts may jeopardize safety and is under no circumstances allowed.
- Verify that the operating environment of the level switch is not a hazardous area location.

Failure to comply with the following requirements will result in the invalidation of the product safety certification.

- Check for risk of process medium build-up on the level switch forks. Avoid situations where drying and coating products may create an excessive build-up (see [Figure 2-2 on page 9](#)) or implement preventative maintenance programs to ensure the build-up is not enough to impair performance.
- Ensure there is no risk of 'bridging' of the level switch forks. Examples of products that create 'bridging' of the forks are dense paper slurries and bitumen.

External surface may be hot.

- Care must be taken to avoid possible burns.

Process leaks may cause harm or result in death.

- Install and tighten process connectors before applying pressure.
- Do not attempt to loosen or remove process connectors while the level switch is in service.

Electrical shock could cause death or serious injury.

- If the level switch is installed in a high voltage environment and a fault condition or installation error occurs, high voltage may be present on leads and terminals.
 - Use extreme caution when making contact with the leads and terminals.
 - Make sure that power to the level switch is off while making connections.
-

2.2 Considerations before installation

Important

Emerson™ is not in a position to evaluate or guarantee the compatibility of the process fluid or other process parameters with the product, options, configuration or materials of construction selected.

2.2.1 Environmental considerations

The Rosemount 2110 Level Switch is a wired point level device for use in open or closed tanks, and pipework. The installation must be in a non-hazardous (safe) area.

All versions of the level switch are weatherproof and protected against the ingress of dust, but must be protected from flooding.

Hygienically-certified and compliant versions have specific hygienic installation instructions in the Rosemount 2110 [Quick Start Guide](#) (see Emerson.com/Rosemount for other language versions).

Avoid installing the level switch near heat sources.

Figure 2-1. Environmental Considerations

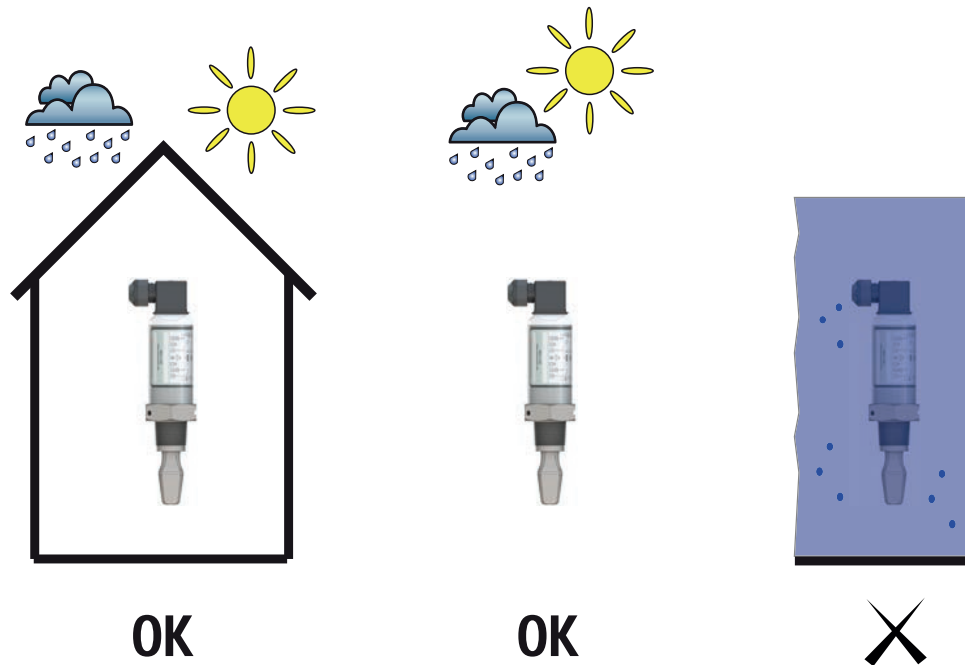

2.2.2 Application considerations

For most liquids, including coating, aerated liquids and slurries, the function is virtually unaffected by flow, turbulence, bubbles, foam, vibration, solid particles, build-up, or properties of the liquid.

The Rosemount 2110 Level Switch (“level switch”) is available for installation in non-hazardous (safe) areas and process temperatures up to 302 °F (150 °C). It can be mounted in any position in the tank or pipe using the ³/₄- or 1-in. threaded or Tri Clamp fitting.

See [Figure 1-2 on page 4](#) for application examples.

Application limits

- Check for risk of process medium build-up on the level switch forks.
Avoid situations where a drying and coating process medium may create an excessive build-up (see [Figure 2-2 on page 9](#)) or implement preventative maintenance programs to ensure the build-up is not enough to impair performance.
- Ensure there is no risk of ‘bridging’ of the level switch forks. Examples of products that can create ‘bridging’ of forks are dense paper slurries and bitumen.
- Ensure the process is operating within the instrument operating temperature and pressure ranges (see [Appendix A: Reference Data](#)).
- Ensure the liquid viscosity is within the recommended viscosity range (see [Appendix A: Reference Data](#)).
Examples of products with too high viscosity are chocolate syrup, ketchup, peanut butter and bitumen; the level switch still operates with these products, but the drain time can be very long.
- Check that the liquid density is higher than 37.5 lb/ft³ (600 kg/m³). Examples of products with a too low density include acetone, pentane, and hexane.
Liquid density affects the switching point e.g. dry-to-wet (see [Figure 2-3 on page 10](#)).
- Check the solids content in the liquid.
As a guideline, the maximum solid particle diameter in the liquid is 0.2-in. (5 mm). Extra consideration is needed when dealing with particles bigger than 0.2-in. (5 mm). Consult the factory for advice.
- In almost all cases, the level switch is insensitive to foams (i.e. does not see the foam).
However, on rare occasions, some very dense foams may be seen as liquid; known examples of this are found in ice-cream and orange juice manufacturing.

Figure 2-2. Avoid Product Build-up

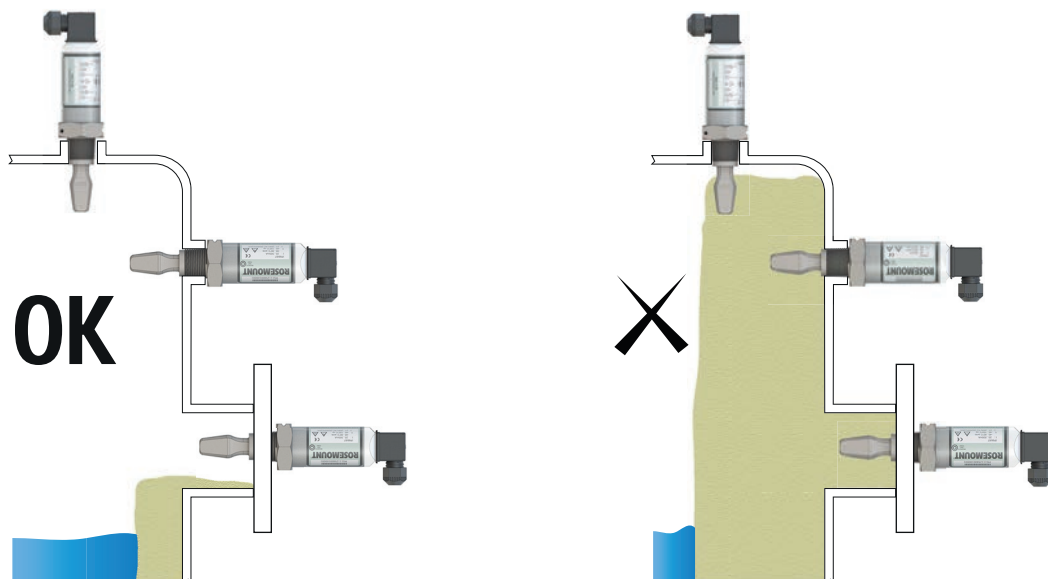
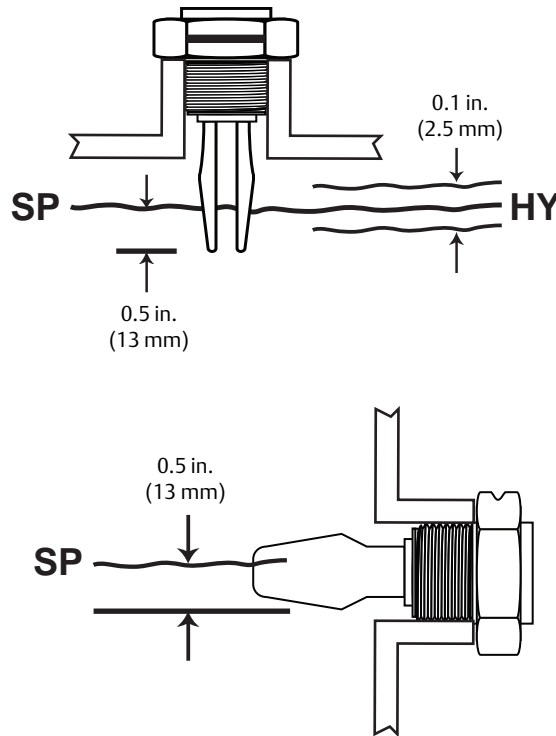

Figure 2-3. Switching Point



SP: Switching point (H₂O)
HY: Switching hysteresis

Note

When mounted vertically, a low density medium has a switching point closer to the process connection. A high density medium has a switching point closer to fork tip.

2.2.3 Installation considerations

Measurement accuracy is dependent upon the proper installation of the level switch. Keep in mind the need for easy access, personnel safety, practical field calibration, and a suitable environment for the level switch.

How to handle the level switch

Do not hold using the forks (Figure 2-4 on page 11).

Device identification

To identify the Rosemount 2110 version, see the label on the housing.

Mounting orientation

Mount the level switch at any angle that allows the liquid level to rise or flow through the fork gap (Figure 2-7 and Figure 2-8 on page 14).

Allow adequate space outside the tank or pipe

Mount the level switch in a position to allow easy access to the wiring terminals. Ensure there is sufficient room for making electrical connections.

For dimensional drawings, see [Appendix A: Reference Data](#) for where to find the latest information.

Figure 2-4. Handling the Rosemount 2110

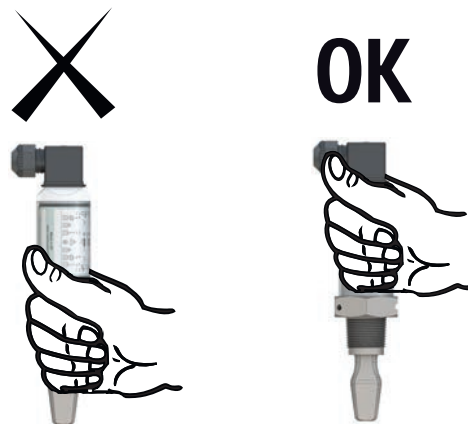
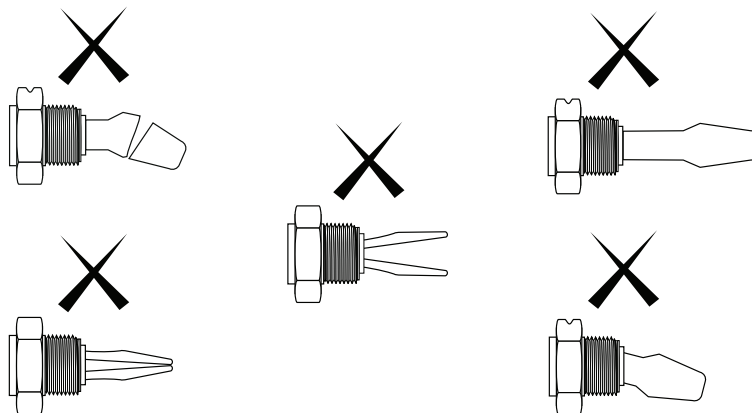

Figure 2-5. Do Not Modify the Rosemount 2110



Other recommendations

- Always install in the normally “on” state
 - High level recommendation is Dry = on (see [Table 2-2 on page 20](#))
 - Low level recommendation is Wet = on (see [Table 2-2 on page 20](#)).
- Always ensure:
 - The overall system is tested during commissioning by using the local magnetic test point ([Figure 3-1 on page 25](#)).
 - The forks do not come into contact with the tank wall, internal fittings, or any other obstructions.
 - The installation does not create tank crevices around the forks where liquid may collect. This can happen with high viscosity and high density liquids.
- Avoid:
 - Installing the level switch near to liquid entering the tank at the fill point.
 - Heavy splashing on the fork.
- Extra consideration is needed if the plant vibration is close to the 1300 Hz operating frequency of the Rosemount 2110.

2.3 Installation procedures

2.3.1 Process connection seals

Figure 2-6. Process Connection Seals

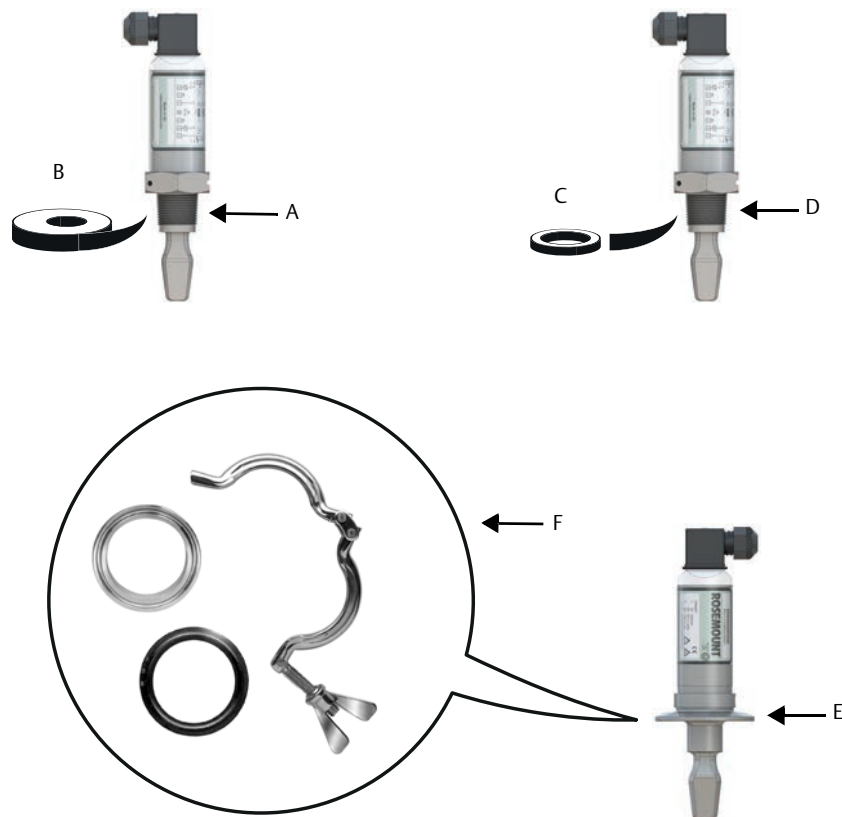

A. NPT or BSPT (R) thread

B. PTFE tape

C. Gasket

D. BSPP (G) thread

E. Tri Clamp

F. The Tri Clamp seal is supplied as in as accessory kit (see [Appendix A: Reference Data](#) for where to find the latest information).

2.3.2 Correct fork alignment

Pipe installation

Ensure the fork is correctly aligned by using the groove or notch as indicated in Figure 2-7.

Figure 2-7. Correct Fork Alignment for Pipe Installation

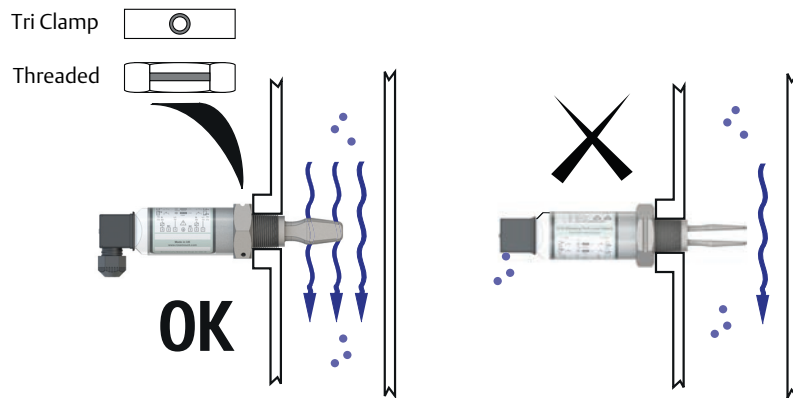

Tank installation

Figure 2-8. Correct Fork Alignment for Tank Installation

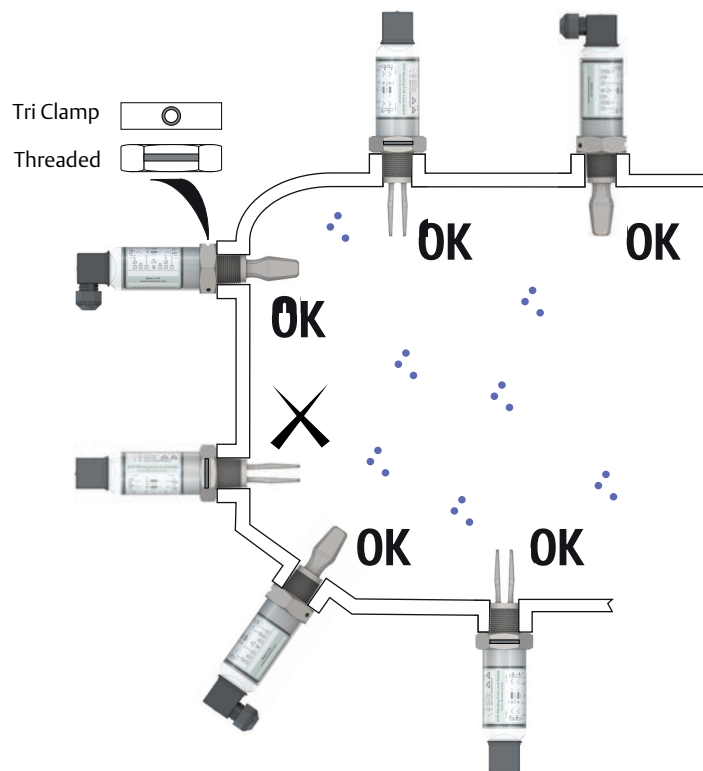

2.3.3 Mounting the threaded versions

Seal and protect the threads

- Use anti-seize paste or PTFE tape according to your site procedures.

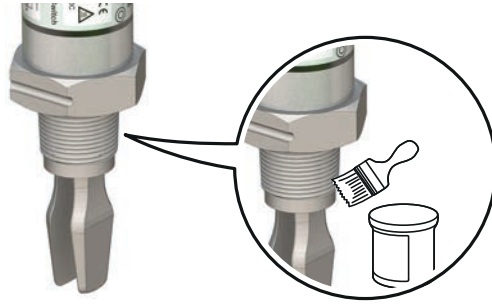

Gasket may be used as a sealant for BSPP (G) threaded connections.

Mount the level switch on tank or pipework

- Threaded tank or pipework connection (vertical installation⁽¹⁾)

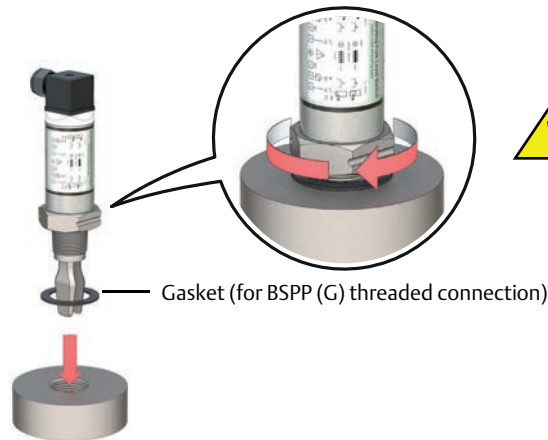

 Tighten using the hexagon only

- Threaded tank or pipework connection (horizontal installation⁽¹⁾)

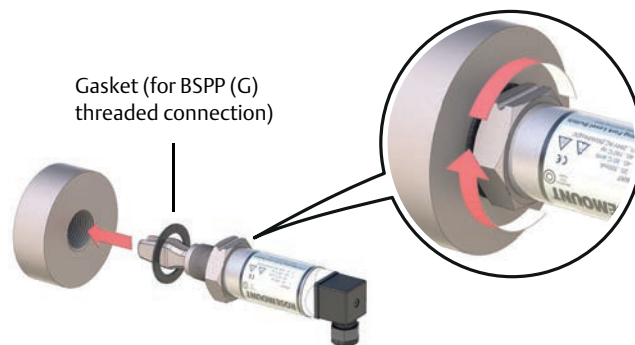

 Tighten using the hexagon only

1. The level switch can be installed at any angle that allows the liquid level to rise or flow through the fork gap.

■ Threaded flange connection

Place the customer supplied flange on the tank nozzle.

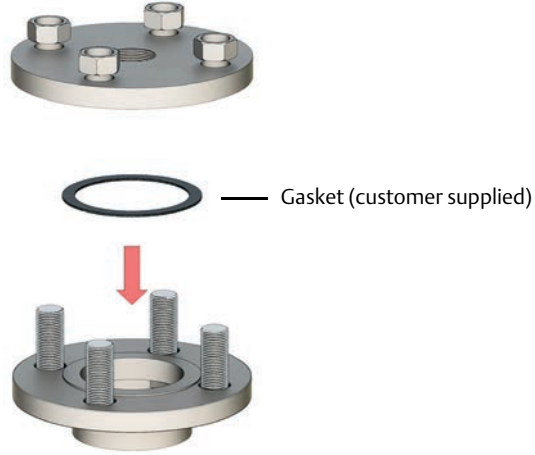

Tighten the bolts and nuts with sufficient torque for the flange and gasket.

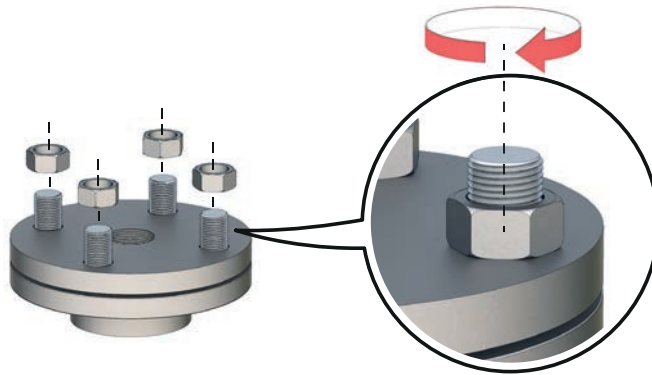

Screw the level switch into the flange thread.

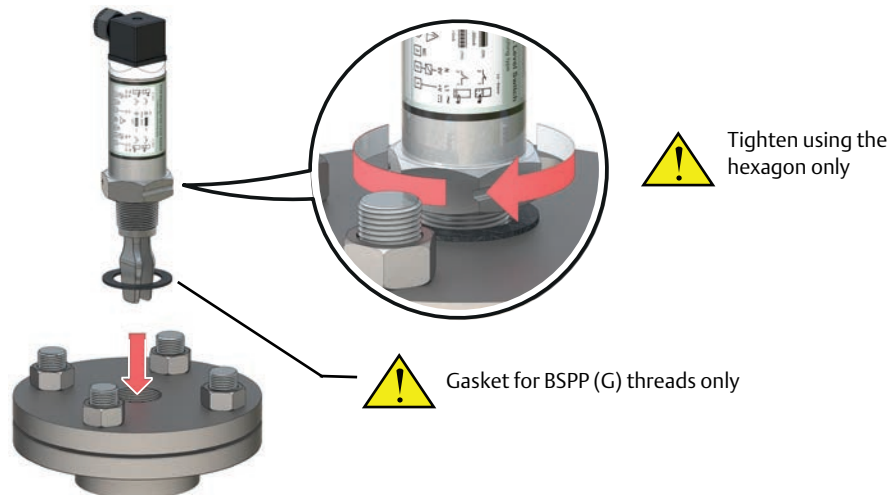

2.3.4 Mounting the Tri Clamp versions Lower the level switch onto the flange face

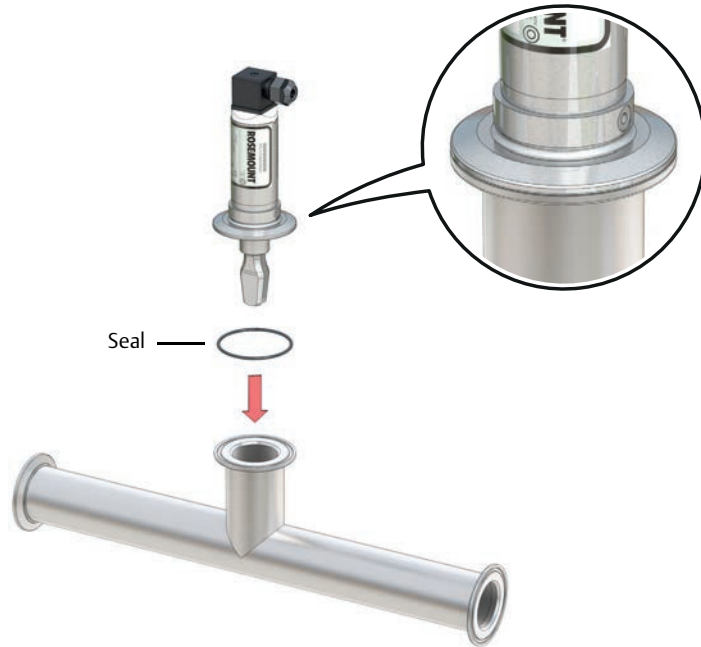

Fit the Tri Clamp

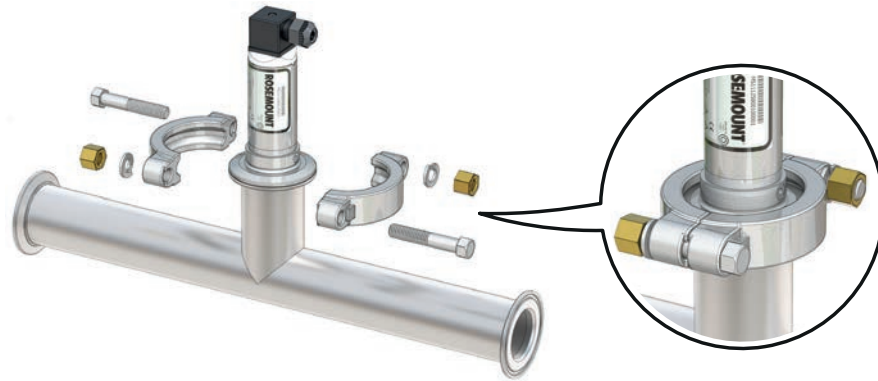

Note

The Tri Clamp and seal are supplied in an accessory kit that has to be ordered separately. See the Rosemount 2110 [Product Data Sheet](#) for ordering information.

2.4 Electrical installation

2.4.1 Prepare the electrical connections

Cable selection

Twisted-pairs and shielded wiring is recommended for environments with high EMI (electromagnetic interference). Two wires can be safely connected to each terminal screw. Maximum wire size is 15 AWG.

Cable gland

The cable gland is integrated in the four-position plug of the level switch. Do not make any modifications to the level switch.

Power supply

The Direct Load electronics option operates on 21 - 264 Vdc or 21 - 264 Vac (50/60 Hz) at the level switch terminals.

The PNP electronics option operates on 18 - 60 Vdc at the level switch terminals.

Mode selection

Table 2-1 on page 19 shows how the mode selection is determined from the wiring connections. Modes are “Dry on, high level alarm” and “Wet on, low level alarm”.



Functions

Table 2-2 on page 20 shows the switched electrical outputs from the PNP and Direct Load electronics for each mode selection.

Note

For direct load switching, a DPST (Double Pole, Single Throw) (on/off) switch must also be fitted for safe disconnection of the power supply. Fit the DPST switch as near to the Rosemount 2110 as possible, keeping the switch free of obstructions. Label the switch to indicate it is the supply disconnection device for the Rosemount 2110.

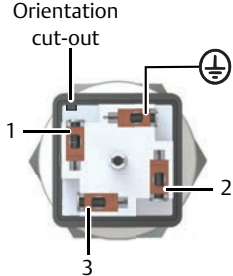
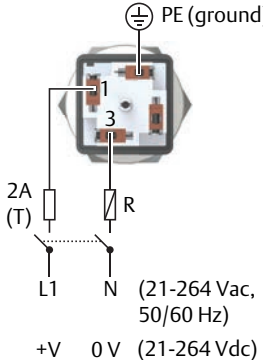
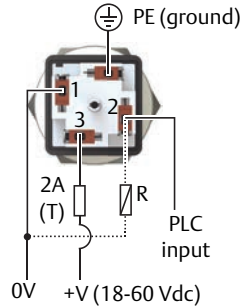
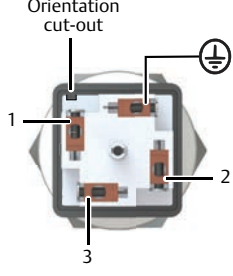
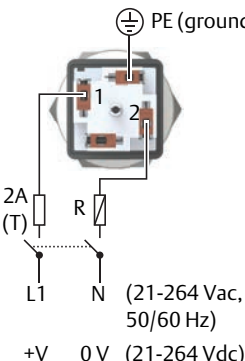
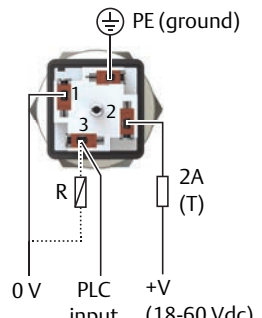
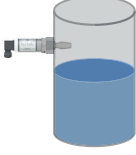

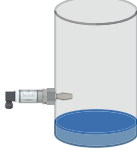
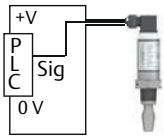
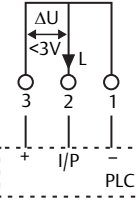
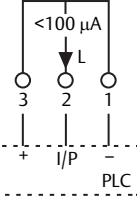
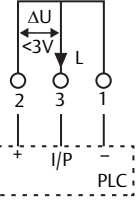
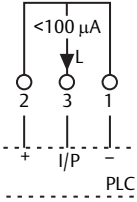
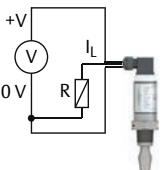
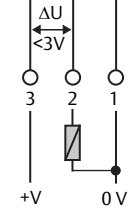
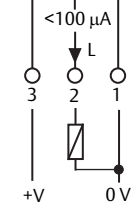
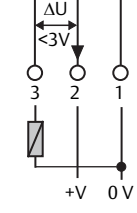
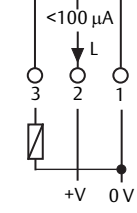
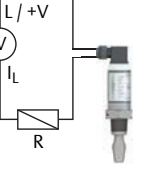
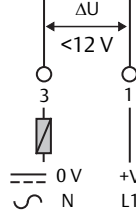
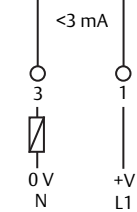
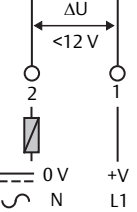
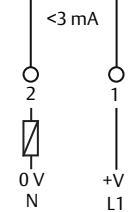
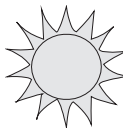
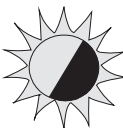
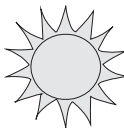
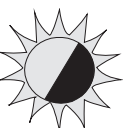

Table 2-1. Mode Selection By Customer Wiring

Modes	Electronics option code 0	Electronics option code 1
	Load switching: ac/dc Direct load switching: ac/dc	PNP output: dc PNP for PLC/SPS connection: dc
<p>Dry = on, high level alarm</p> 		
<p>Wet = on, low level alarm</p> 		
	 R = external load (must be wired)	 R = external load
	Maximum inrush current: 5A (over current protected)	
	I maximum continuous: 500 mA	
	I minimum continuous: 20 mA	Supply current: 3 mA nominal
	Voltage drop: 6.5 V @ 24 Vdc / 5.0 V @ 240 Vac	Voltage drop: < 3 V
	I load off: <3 mA	I load off: <0.5 mA

Relay connection warning (for direct load switching)

The Rosemount 2110 requires a minimum current of 3 mA, which continues to flow when it is 'off'. When selecting a relay to wire in series with the Rosemount 2110, the drop-out voltage of the relay must be greater than the voltage generated across the relay coil when 3 mA flows through it.

Table 2-2. Functions

	Mode: dry on, high level alarm		Mode: wet on, low level alarm	
				
PLC (positive output) 				
PNP dc 				
Load switching ac/dc 				
LED	 LED on continuously	 LED flashes every second	 LED on continuously	 LED flashes every second
Electrical load	 = Load on		 = Load off	

Note

For direct load switching, a DPST (Double Pole, Single Throw) (on/off) switch must also be fitted for safe disconnection of the power supply. Fit the DPST switch as near to the Rosemount 2110 as possible, keeping the switch free of obstructions. Label the switch to indicate it is the supply disconnection device for the Rosemount 2110.

2.4.2 Wiring

The Rosemount 2110 meets IP66 and IP67 weatherproof ratings when correctly assembled with the supplied connector and suitable cable. Ensure seals are in place to maintain the weatherproof ratings.

Note

Use only the connector supplied and ensure the cable gland is pointing downwards or sideways.

Wiring procedure

1. Remove the plug cover and cable gland.

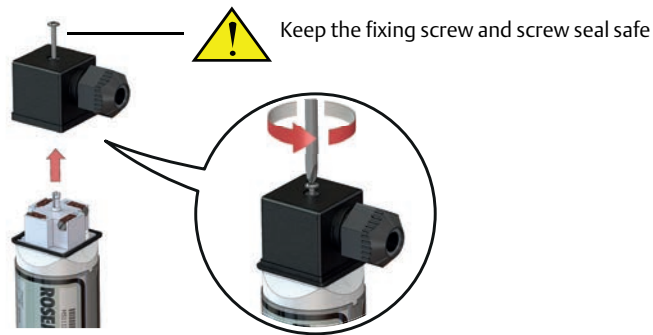

2. Pull the cable through the cable gland.

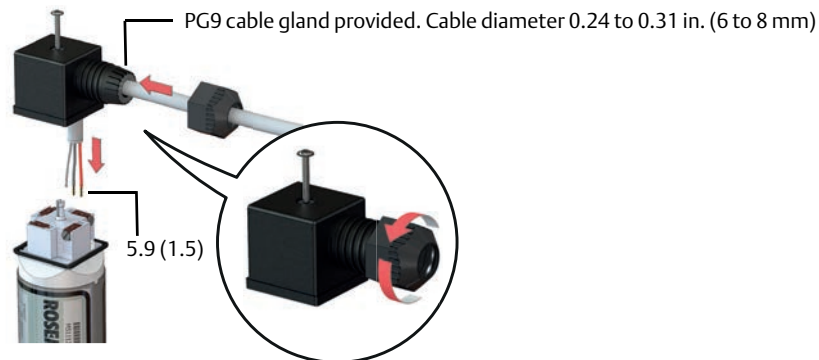

3. Connect the cable wires.

[Table 2-1 on page 19](#) shows the wiring connections for each electronics option.

4. Ensure proper grounding

Make sure grounding is done according to national and local electrical codes. Failure to do so may impair the protection provided by the equipment.

Signal cable shield grounding at power supply end

Make sure the instrument cable shield is:

- Trimmed close and insulated from touching the level switch housing.
- Connected to the next shield if cable is routed through a junction box.
- Connected to a good earth ground at the power supply end.

Figure 2-9. Cable Shield Connection (Power Supply End)

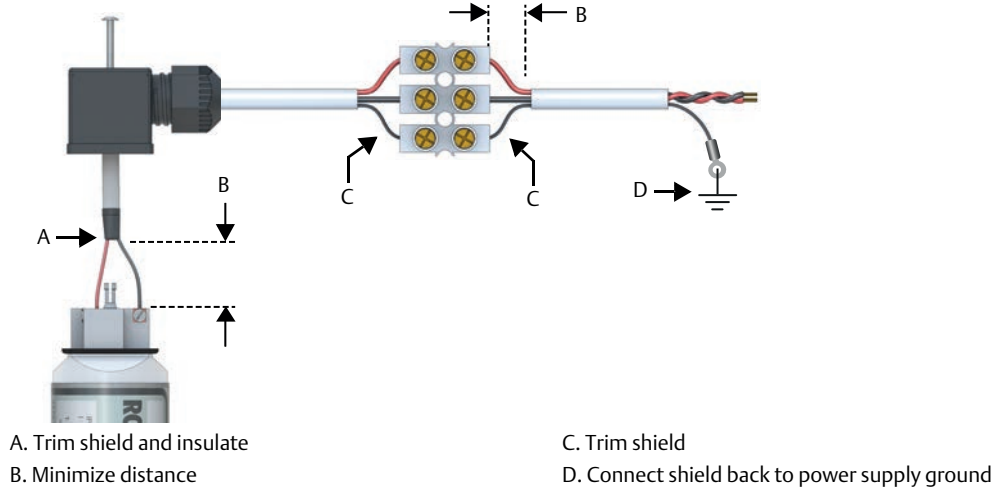

Signal cable shield grounding at level switch end

Make sure the instrument cable shield is:

- Trimmed close and insulated at the power supply end.
- Connected to the next shield if cable is routed through a junction box.
- Connected to the potential earth (ground) terminal.

Figure 2-10. Cable Shield Connection (Level Switch End)

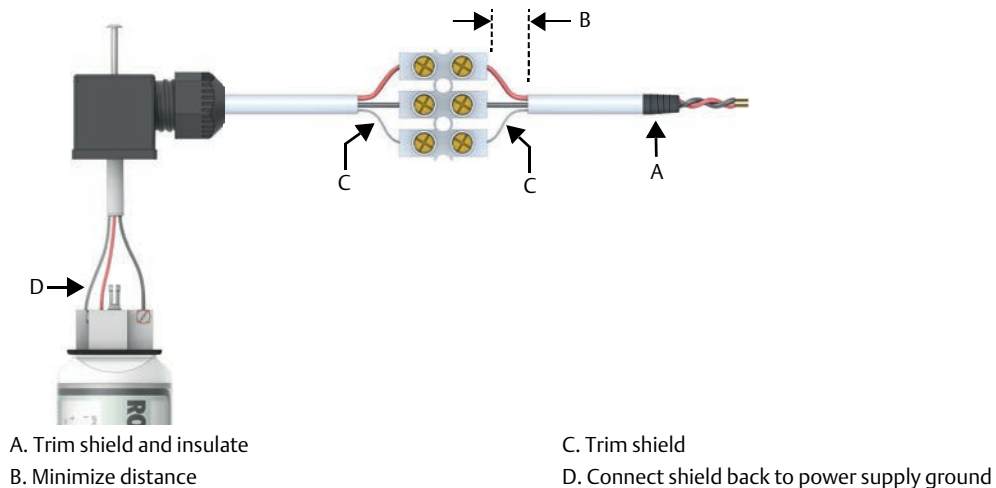

5. Re-fit the plug cover and tighten the cable gland.
 - a. The plug cover can be re-fitted in any one of four positions.

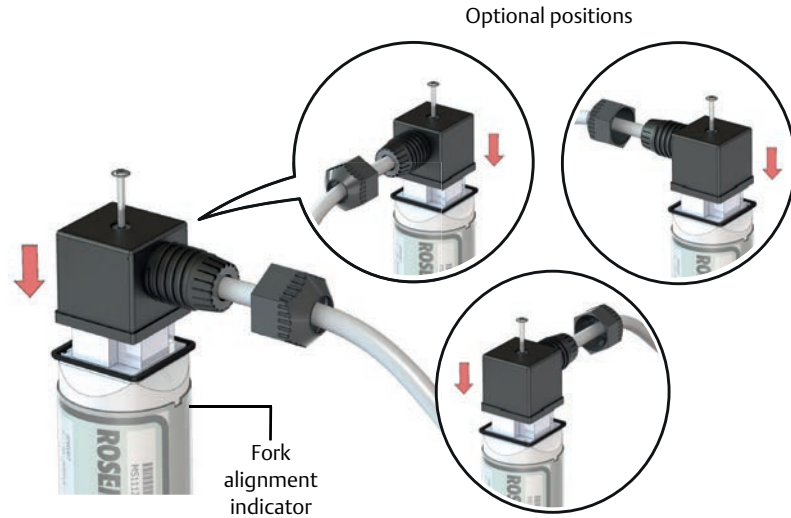

- b. Ensure the cable gland is pointing downwards or sideways.



- c. Secure the plug cover with the plug screw and washer, and tighten cable gland.

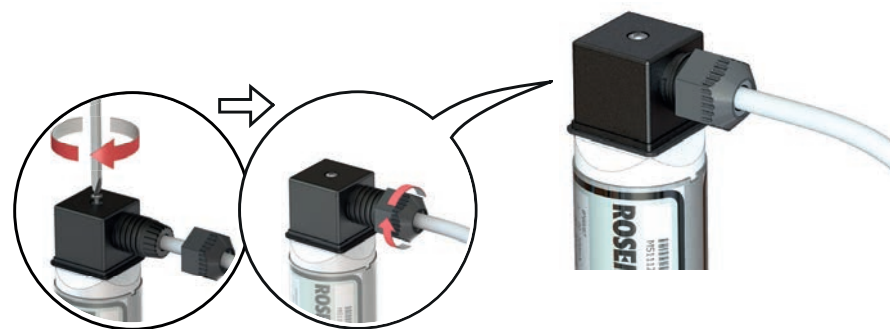







d. If possible, arrange the wiring with a drip loop.

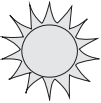

6. Connect the power supply when ready to apply power.

2.5 LED Indication

Table 2-3. LED Indication

	LED flash rate	Switch status
	Continuous	Output state is on
	1 every second	Output state is off
	1 every 2 seconds	Uncalibrated
	1 every 4 seconds	Load fault; load current too high; load short circuit
	2 times / second	Indication of successful calibration
	3 times / second	Internal fault (micro, ROM, or RAM)
	Off	Problem (e.g. supply)

Section 3 Troubleshooting

Magnetic test point	page 25
Inspection	page 25
Maintenance	page 26
Troubleshooting	page 26
Spare parts	page 26
Service support	page 27

3.1 Magnetic test point

A magnetic test point is marked on the side of the housing to allow a functional test of the Rosemount™ 2110 Level Switch (“level switch”) in the overall system. By touching a magnet to the target, the level switch output will change state while the magnet is present.

Figure 3-1. Magnetic Test Point

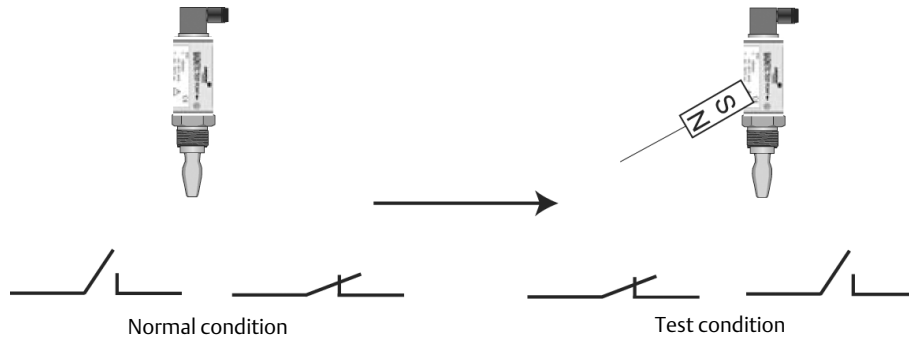

3.2 Inspection

Visually examine the Rosemount 2110 and do not use if it is damaged. Check that the connector and seals are correctly fitted, and that the connector fixing screw and gland are tight.

Ensure the LED flash rate is 1 Hz or constantly on. For anything else, see “LED Indication” on page 24.

3.3 Maintenance

Figure 3-2. Maintenance

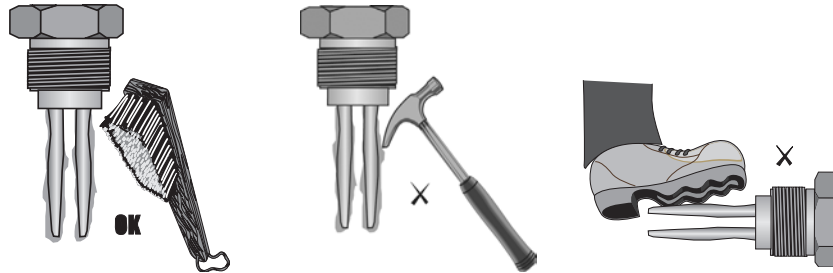

Note
Only use a soft type brush for cleaning.

3.4 Troubleshooting

For a malfunction, see “Troubleshooting Chart” on page 26 for possible causes.

Table 3-1. Troubleshooting Chart

Fault	Symptom/indication	Action/solution
Does not switch	No LED, no power	Check the power supply, check the load on direct load switching electronics model
	LED 3 flashed per second	Internal failure, contact supplier
	LED 1 flash every 2 seconds	Uncalibrated, return to supplier
	LED 1 flash every 4 seconds	Load fault, load current too high, load short circuit, check installation
	Fork damage	Replace
	Thick encrustation on forks	Carefully clean the fork
	5 second delay on changing mode/delay	Wait 5 seconds
Incorrect switching	Dry = On, Wet = On set correctly	Check wiring in the connector-see Table 2-1 on page 19
Faulty switching	Excessive electrical noise	Suppress the cause of the interference

3.5 Spare parts

See Appendix A: Reference Data for where to find the latest spares information.

3.6 Service support

To expedite the return process outside of the United States, contact the nearest Emerson™ representative.

Within the United States, call the Emerson Instrument and Valves Response Center using the 1 800 654 7768 toll-free number. This center, available 24 hours a day, will assist you with any needed information or materials.

The center will ask for product model and serial numbers, and will provide a Return Material Authorization (RMA) number. The center will also ask for the process material to which the product was last exposed.

⚠ CAUTION

Individuals who handle products exposed to a hazardous substance can avoid injury if they are informed of, and understand, the hazard. If the product being returned was exposed to a hazardous substance as defined by OSHA, a copy of the required Safety Data Sheet (SDS) for each hazardous substance identified must be included with the returned goods.

Appendix A Reference Data

A.1 Product Certifications

To view current Rosemount™ 2110 Product Certifications, follow these steps:

1. Go to Emerson.com/Rosemount.
2. In the **Products** section, click **Level Measurement** and then **View Products**.
3. Click **Rosemount 2110 Level Switch - Vibrating Fork** to view the product details page.
4. Scroll as needed to the green menu bar and click **Documents & Drawings**.
5. Click **Manuals & Guides**.
6. Select the Quick Start Guide.

A.2 Ordering Information, Specifications, and Drawings

To view current Rosemount 2110 Ordering Information, Specifications, and Drawings, follow these steps:

1. Go to Emerson.com/Rosemount.
2. In the **Products** section, click **Level Measurement** and then **View Products**.
3. Click **Rosemount 2110 Level Switch - Vibrating Fork** to view the product details page.
4. Scroll as needed to the green menu bar and click **Documents & Drawings**.
5. For installation drawings, click **Drawings & Schematics** and select the appropriate document.
6. For ordering information, specifications, and dimensional drawings, click **Data Sheets & Bulletins** and select the appropriate Product Data Sheet.

Global Headquarters

Emerson Automation Solutions

6021 Innovation Blvd.
Shakopee, MN 55379, USA
+1 800 999 9307 or +1 952 906 8888
+1 952 949 7001
RFQ.RMD-RCC@Emerson.com

North America Regional Office

Emerson Automation Solutions

8200 Market Blvd.
Chanhassen, MN 55317, USA
+1 800 999 9307 or +1 952 906 8888
+1 952 949 7001
RMT-NA.RCCRFQ@Emerson.com

Latin America Regional Office

Emerson Automation Solutions

1300 Concord Terrace, Suite 400
Sunrise, FL 33323, USA
+1 954 846 5030
+1 954 846 5121
RFQ.RMD-RCC@Emerson.com

Europe Regional Office

Emerson Automation Solutions

Neuhofstrasse 19a P.O. Box 1046
CH 6340 Baar
Switzerland
+41 (0) 41 768 6111
+41 (0) 41 768 6300
RFQ.RMD-RCC@Emerson.com

Asia Pacific Regional Office

Emerson Automation Solutions

1 Pandan Crescent
Singapore 128461
+65 6777 8211
+65 6777 0947
Enquiries@AP.Emerson.com

Middle East and Africa Regional Office

Emerson Automation Solutions

Emerson FZE P.O. Box 17033
Jebel Ali Free Zone - South 2
Dubai, United Arab Emirates
+971 4 8118100
+971 4 8865465
RFQ.RMTMEA@Emerson.com

 [Linkedin.com/company/Emerson-Automation-Solutions](https://www.linkedin.com/company/Emerson-Automation-Solutions)

 [Twitter.com/Rosemount_News](https://twitter.com/Rosemount_News)

 [Facebook.com/Rosemount](https://www.facebook.com/Rosemount)

 [Youtube.com/user/RosemountMeasurement](https://www.youtube.com/user/RosemountMeasurement)

 [Google.com/+RosemountMeasurement](https://www.google.com/+RosemountMeasurement)

Standard Terms and Conditions of Sale are available upon request.
The Emerson logo is a trademark and service mark of Emerson Electric Co.
Rosemount is a mark of one of the Emerson family of companies.
All other marks are the property of their respective owners.
© 2018 Emerson. All rights reserved.