

Reliable Fisher® Control Valve Solutions

Achieve greater success by partnering with Emerson

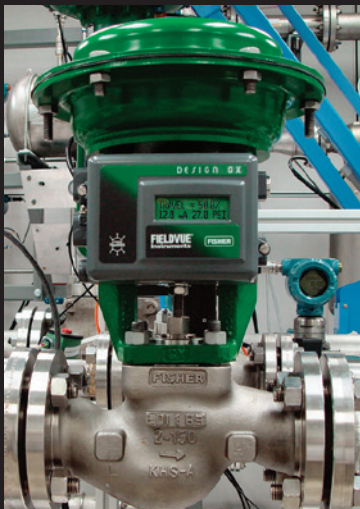

Reliable Control Valve Solutions



In the day-to-day operation of your plant you have a long list of concerns, like meeting production schedules, maintaining product quality, and improving the efficiency of plant utilities, to name just a few. The last thing you should have to worry about is the performance of your plant's control valves. The answer to that concern is Emerson.

Emerson wants to be your partner.

With Emerson, you'll have the support of a global company with extensive international engineering, research, sales, marketing, manufacturing, and service operations. Which means you'll have access to leading control valve and instrument technologies that offer new levels of performance and reliability. Regardless of your industry. Regardless of your location.

If you can't count on your control valves, you can't count on your process! That's why operations like yours have chosen Fisher final control capabilities.

A Fisher valve with a FIELDVUE™ digital valve controller can provide you with real-time predictive intelligence, not just numbers and graphs. So you will know there's a problem and can take action before your process is impacted! The Fisher valve with FIELDVUE instrument is a core component of Emerson's PlantWeb™ digital plant architecture.

PlantWeb digital plant architecture uses open communication standards to link intelligent field devices, automation systems, and applications in a plantwide network. Operations can run production with greater confidence in automation as they tune the process for optimal throughput, quality, and availability while reducing the overall cost of operations.

Whatever your control valve challenge, we can get it done!

Technology Leader

All products bearing the Fisher brand identity have one thing in common: differentiating technologies. Technologies that are the result of industry expertise, research, creativity and a 135-plus year tradition of answering control valve needs.

We know the process industries well. We are familiar with your people and facilities. In fact, millions of dollars of research are invested annually in solving the control valve issues that are important to you.

When we say a Fisher product will do the job for your application, we mean it. We design and manufacture Fisher control valves and instruments according to industry codes and standards and prove our products in our own research and engineering facilities. Nothing is based on chance.

When you own a Fisher product, you can feel confident that it will operate reliably and will deliver the performance you expect.

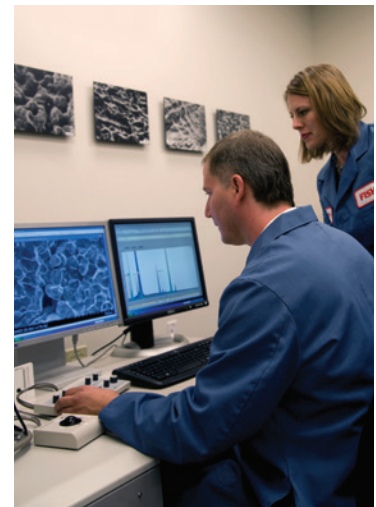

Backed By Research

We operate flow loops that can duplicate actual dynamic flow conditions encountered in the processing industries. These research findings are utilized in the development and refinement of Fisher control valves. Our global capabilities for validating control valve performance are unmatched in the industry. Research and engineering capabilities extend worldwide with engineers and labs in North America, Europe, and Asia. We can help you schedule a visit to our labs.

The Right Materials

Understanding materials allows us to know their application limits in various processes, which benefits you. Emerson has a fully-equipped materials lab that helps ensure that Fisher products deliver excellent performance.

Industries Served

Delivering Results



During the last 135-plus years, the industries that use control valves have grown in number, in capacity, and in sophistication. We have played a part in their growth by developing control valves to meet ever-changing requirements. Below are some examples of how we serve customers around the world.

Hydrocarbon

Upstream - The Long Lake Oil Sands Extraction Project in Alberta, Canada, specified Fisher valves with Fisher FIELDVUE digital valve controllers to help improve the efficiency and economics of oil sands processing.

Refining - The Schwechat refinery, located in Vienna, Austria, specified over eight thousand Fisher control valves to help process nine million metric tons of crude oil per year.

Offshore/Marine - BP Angola specified Fisher products to automate the floating production, storage, and offloading vessel that will develop the Greater Plutonio Deepwater offshore oil fields of Angola, Africa.

Liquefied Natural Gas - Twenty-five Fisher optimized antisurge control valves will provide reliable surge protection for five critical compressor trains in an LNG facility in Brunei.

Chemical

Nantong Cellulose Fibers Co., Ltd. specified Fisher valves with FIELDVUE instruments for its acetic acid unit located in the Jiangsu province of China.

Power

ENELPOWER specified sixty-nine Fisher valves with FIELDVUE instruments for ENEL Production's Sulcis power plant on the island of Sardinia near Italy.

Taiwan Power Company specified over six hundred Fisher valves with FIELDVUE instruments as key balance of plant and containment vessel control devices within a 2,700 megawatt nuclear power plant to be constructed near Taipai.

Industries Served

Pulp and Paper

Caraustar's paperboard mill in Connecticut, United States, is using Fisher products to achieve full automation of its 525-tons-per-day mill.

Food and Beverage

A Danish food processor, Aarhus United, specified Fisher valves with FIELDUVE instruments to help produce a wide range of specialty vegetable oils.

Metals and Mining

BHP Billiton's nickel/cobalt mine in Ravensthorpe, Australia, specified Emerson's products for digital automation and control of minerals processing.

Life Sciences

Celltrion, Inc. specified Fisher and Baumann™ control valves with Fisher FIELDVUE digital valve controllers for its biopharmaceutical manufacturing facility in South Korea.

Semiconductor

Industry-leading semiconductor manufacturers around the world rely on Baumann and Fisher control valves in their cleanroom HVAC systems. Baumann low-flow, corrosion-resistant lined valves are specified for precise Ph control in their water tower systems.

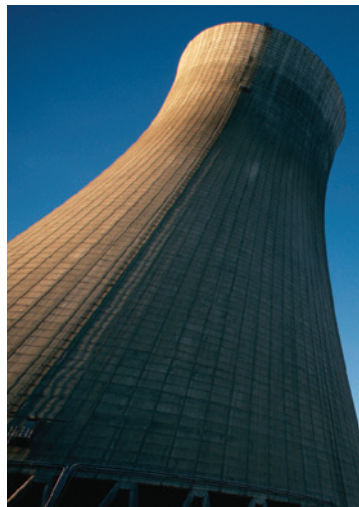

Sliding-Stem Control Valves

Products That Deliver



We have the broadest range of sliding-stem control valves available anywhere in a variety of construction materials, flow characteristics, and end connections. Complementary actuators and accessories are also available. Popular sliding-stem valve product lines include: Fisher easy-e™ globe valves and Baumann valves.



Universal -

Fisher easy-e valve line popularized the concept of one valve body with interchangeable trim. Can be used effectively, plantwide, in a number of applications.



High Pressure, High Flow -

Built-to-last design with rugged cage guiding and hardened trim materials. Fisher ENVIRO-SEAL™ and HIGH-SEAL packing systems in the valve provide a tight stem seal for fugitive emissions control.



Steam Conditioning -

Enhanced pressure reduction capabilities as well as highly efficient and accurate steam conditioning performance in a single valve. Provides the ultimate combination of performance and maintainability.

Sliding-Stem Control Valves



Chemical and General Service - Unmatched innovation, technology, and reliability. Compact size, anti-corrosion finish, certified emission control packing and integrated digital technology.



Utility and Low Flow Service - Compact, low-weight Baumann control valves help ensure reduced installation and maintenance costs. Designs include low flow technology and exceptional deadband and hysteresis characteristics.



Sanitary - Designed to satisfy the stringent demands of the pharmaceutical and biotechnology industries. In compliance with 3A Sanitary Standards Inc. requirements.



Environmental Requirements - Fisher ENVIRO-SEAL valve packing systems are designed to control emissions below 100 ppmv. Provide extended service life.



Sweet or Sour Oil and Gas Applications - Special deep-bore hammer nut for increased safety. Fisher Micro-Form valve plug is sour gas compatible. Fisher easy-Drive™ electric actuator was designed to protect the environment from methane gas venting.



High-Pressure Gas Service - Innovative Fisher FloPro selectable flow rate feature. Designed for high-pressure separators, scrubbers, and other gas processing equipment.

Rotary Control Valves

Meeting Control Needs



When capacity and performance are the requirements, the Emerson line of Fisher rotary valves is the answer. Popular rotary valve products include ball, eccentric disc, eccentric plug, and butterfly valves with such familiar tradenames as Vee-Ball™ and Control-Disk.™



Proven Performance -

Fisher Vee-Ball control valves feature the V-notch ball for nonclogging, high capacity flow control. Designed for gas, steam, liquids and fibrous slurries where reducing process variability is a must.



Hard-to-Handle Fluids -

Fisher V500 and CV500 control valves offer low operating torque and combine the ruggedness of a globe valve with the efficiency of a rotary valve. Well suited to erosive, coking and other hard-to-handle fluids.



High Performance -

Fisher 8580 control valves are reliable, high performance butterfly valves suitable for throttling applications that require extremely low leakage rates.

Rotary Control Valves

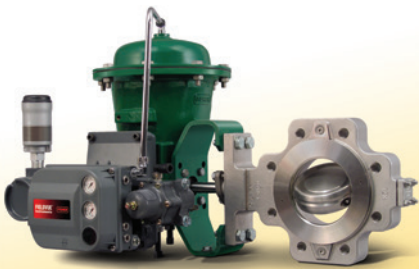

Wide Control Range -

Fisher Control-Disk valves have a wide control range and offer excellent throttling performance to control closer to target set point, regardless of process disturbances.

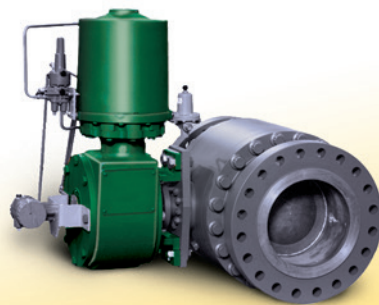

Pipeline Control -

Designed from the ground up with features for optimized pressure, flow, and process control. Used in gas and oil flow streams. Special Fisher Aerodome or Hydrodome attenuators reduce noise and cavitation effects that cause pipeline vibration.



Tight Shutoff -

Fisher 8590 valves survive in extreme pressure and temperature conditions. Exceptional shutoff rates with bidirectional soft seal ring. Fisher HPS and Phoenix III metal seals offer added shutoff capabilities.



Automated On-Off Performance -

Fisher 8580 rotary valves with FieldQ™ rack-and-pinion actuators offer automated on-off, quarter-turn performance and feature either a soft or metal seal for enhanced shutoff.



Field Instruments and Valve Accessories

Controlling Valves and the Process



A wide selection of Fisher digital, pneumatic and electronic instruments control valve position and variables such as level, pressure, or temperature. Popular Fisher products include: FIELDVUE digital valve controllers, FIELDVUE digital level transmitters, ValveLink™ software, and pressure and temperature controllers.



Digital Valve Controller -
The Fisher FIELDVUE digital valve controller family has powerful diagnostic capabilities. Modular design and minor loop feedback.



Digital Valve Controller -
Non-contact, linkage-less travel feedback and local user interface with LCD and four pushbuttons for menu navigation. Powerful FIELDVUE diagnostic capabilities.



Valve Diagnostics Software -
ValveLink software is the configuration, calibration, and diagnostic tool used with FIELDVUE Instrumentation. It uses predictive intelligence to improve the availability and performance of control valves.

Field Instruments and Valve Accessories



Wireless Position Monitor -
Rugged, reliable, easy-to-use measurement device that monitors equipment position with a percent of span plus on/off indication.



Digital Level Transmitter -
Provides installation flexibility. Built-to-last design. HART® and FOUNDATION™ fieldbus certified, bringing digital advantages to liquid level control.



Pressure Controller -
Offers long-lasting dependability. Simply constructed. Can reduce steady-state air/gas consumption to as little as 1/10th that of other products.



Electro-Pneumatic Transducer -
Special free-flow design resists plugging. Approved for use with natural gas as the supply medium.



Liquid Level Controller -
Designed for controlling level on gas separators and scrubbers. Sour gas service ready. Low bleed relays conserve energy and reduce impact on the environment.



Volume Booster -
Used in conjunction with a positioner on a throttling control valve to increase stroking speed. Connectors and piping can be installed for diagnostic testing.

Severe Service Solutions

Meeting Your Needs



For decades, we have been providing solutions for severe service control valve applications in the power and hydrocarbon industries. Special control problems—either anticipated or existing—that involve extremes in temperature, pressure, corrosion, erosion, noise, flashing or cavitation, have a Fisher valve solution.

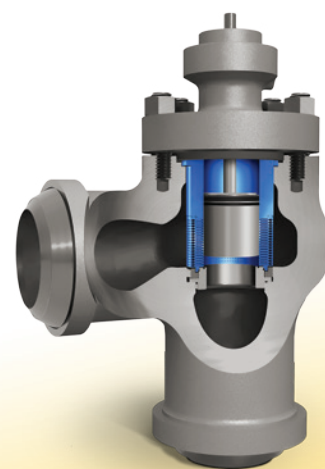

Cavitating Liquid -

Cavitrol™ III trim contains a multitude of specially shaped holes that reduce flow turbulence. The holes are radially aligned to flow from one restriction to another. Both features dissipate the fluid pressure and prevent cavitation.

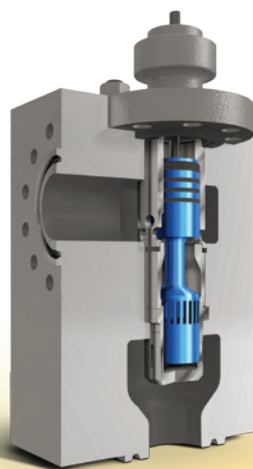

Outgassing -

Dirty Service Trim for Outgassing (DST-G) is used in services where the fluid has dissolved gases that are released from solution due to a reduction in pressure. DST-G trim allows large 6.35 mm (¼-inch) particulate to pass.

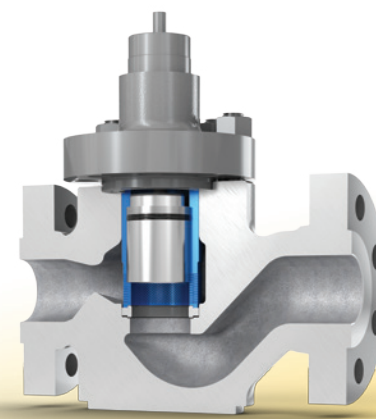

Drilled Hole Noise Trim -

Whisper Trim™ III is a drilled hole trim available in a variety of control valve sizes and styles. It delivers excellent noise reduction. The design architecture even allows for flexibility of size, pressure class, materials, rangeability, and attenuation.

Severe Service Solutions

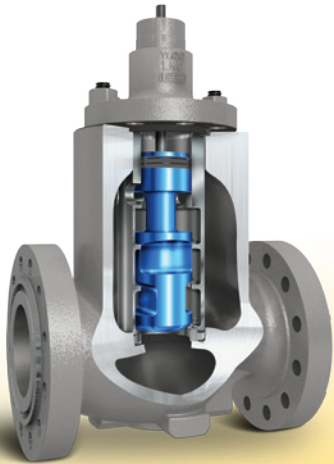

Cavitating Dirty Flow -

NotchFlo™ DST trim uses a series of flow restrictions and expansions to control the pressure drop of the fluid. The notched plug allows up to 12 mm (½-inch) particulate to flow through the trim without plugging.

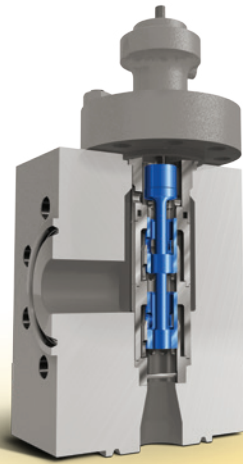

Cavitating Dirty Flow, Customized -

Dirty Service Trim (DST) provides cavitation-control for applications with entrained particulate. It uses a combined axial and radial flow path that features large openings allowing particulate up to 19 mm (¾-inch) in diameter to pass through the valve.

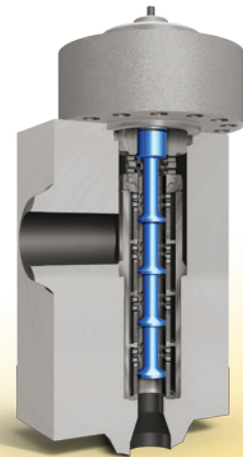

Large Pressure Drops -

Each of the Cavitol IV trim stages has a successively large flow area. The results is very efficient operation because more than ninety percent of the overall pressure drop is taken in the initial stages where there is little danger of cavity formation.

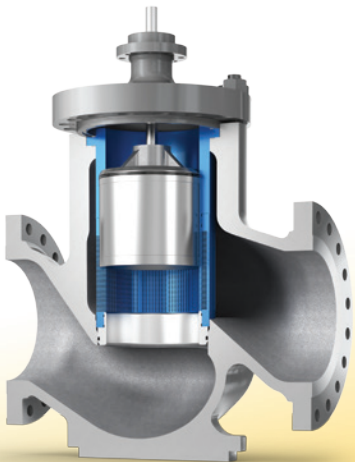

Stacked Disk Noise Trim -

WhisperFlo™ trim offers state-of-the-art noise attenuation in vapor, gas, or steam applications involving high pressure drops. It is a laser cut, stacked-disk cage assembly that is available in globe and angle bodies for the most severe applications.

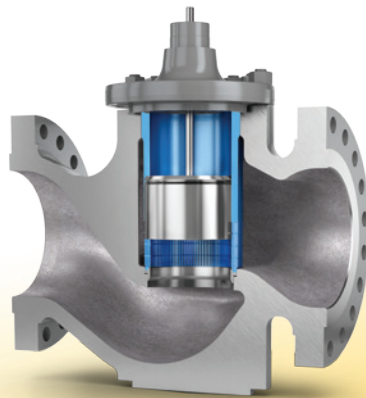

Slotted Noise Trim -

Whisper Trim I offers proven attenuation of aerodynamic noise in vapor, gas, or steam applications involving low to medium pressure drops. It offers economical, dependable noise attenuation. It offers great application flexibility.

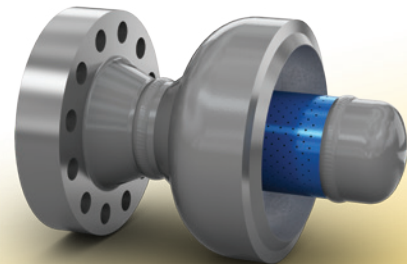

Diffusers -

The 6010 inline diffuser places back pressure on the control valve, thereby reducing the turbulence and pressure drop across the valve, which are main contributors in damaging noise and vibration.

Capabilities That Serve You

Global Reach, Local Service



One thing all control valve buyers have in common is a desire to know as much as possible about their prospective purchase and the company that manufactures it. Fisher valve operations started in 1880 in Marshalltown, Iowa, United States. Since then, Fisher valve operations have grown to employ more than 3,700 people worldwide. We're the largest control valve and regulator manufacturer in the world.

Manufacturing

To meet local product and delivery needs, Fisher manufacturing plants are located in each world area. Each manufacturing site is tied directly to Fisher product design centers via the latest communication links, helping ensure that manufacturing operations utilize the most up-to-date product information. This means that each Fisher product meets design specifications and performs as intended, regardless of where its individual or component parts were manufactured.

Application Assistance

Control valves are an investment, so you want to speak with someone one-on-one who knows about you and your business. The Emerson sales network has extensive application experience and can recommend the most suitable products for your application. Because of the technical nature of the Fisher product line, most of the Emerson network are graduate engineers with substantial factory training. At Emerson, we've built our reputation not just on our quality Fisher products, but also on our people and their dedication to service. Wherever you are, there's an Emerson salesperson to discuss your control needs.

Sizing and Specification

Fisher Specification Manager software is available through your local salesperson. The software offers a powerful set of tools for quickly producing an ISA specification sheet, improving noise prediction calculations and exporting dimensional data for Fisher and Baumann control valves. You'll find it easy to learn and use.

Serving You for the Life of Your Plant

Emerson is a provider of trusted expertise for reliability-centered control valve maintenance. A network of service centers, manufacturing sites, and sales representatives puts experienced professionals where and when they are needed. Highly skilled technicians provide cost effective maintenance, valve reliability, and increased process availability through flexible, local service.

Capabilities that Serve You

OEM Replacement Parts

The Emerson manufacturing network supports Fisher parts needs in any emergency. The integrated sales channel and business partner networks offer a local point of customer contact with delivery of process control application knowledge and complimentary capabilities. Flexible deployment of highly skilled, factory-trained Emerson technicians strategically located near customer process plants provide repair capabilities for all types of control valves and associated field instruments. Emerson's comprehensive quick ship programs, along with a supporting distribution network of process control products and spare parts, guarantee immediate response to customer needs.



Diagnostic Services

When precision is critical to keep your process in peak performance, you need your valves to perform to industry and factory specifications. Emerson's skilled, certified field technicians carefully analyze control valves using diagnostic services to identify maintenance priorities and develop a proactive plan detailing when devices should be repaired or replaced with next generation technologies. After diagnostic service, technicians produce a clear report indicating asset health, areas of potential risks, and a prioritized recommend action plan.





Training

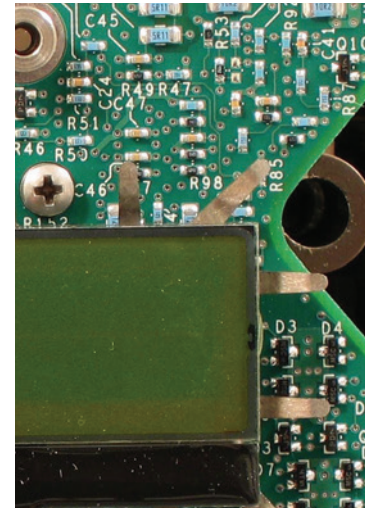

Today, the need for training is more critical than ever to achieve and maintain cost-effective process operations. So whether it's at your site, our site, or the website, we work hard to ensure you know how to get the best from your Fisher products through a selection of valve and instrument training courses.

Documentation

Engineering requirements behind Fisher products necessitate a great many product bulletins, instruction manuals, and sales brochures. These documents are available from sales locations. Or you can view them in PDF format at www.EmersonProcess.com/Fisher/Documentation.



 <http://www.Facebook.com/FisherValves>
 <http://www.Twitter.com/FisherValves>

 <http://www.YouTube.com/user/FisherControlValve>
 <http://www.Linkedin.com/groups/Fisher-3941826>

© 2005, 2015 Fisher Controls International LLC. All rights reserved.

Fisher, PlantWeb, FIELDVUE, easy-e, Baumann, ENVIRO-SEAL, easy-Drive, Vee-Ball, Control-Disk, POSI-SEAL, FieldQ, ValveLink, Wizard, Cavitrol, Whisper Trim, NotchFlo, and WhisperFlo are marks owned by one of the companies in the Emerson Process Management business unit of Emerson Electric Co. Emerson Process Management, Emerson, and the Emerson logo are trademarks and service marks of Emerson Electric Co. All other marks are the property of their respective owners.

Emerson Process Management
 Marshalltown, Iowa 50158 USA
 Sorocaba, 18087 Brazil
 Chatham, Kent ME4 4QZ UK
 Dubai, United Arab Emirates
 Singapore 128461 Singapore
www.Fisher.com

The contents of this publication are presented for informational purposes only, and while every effort has been made to ensure their accuracy, nothing herein is to be construed as a warranty or guarantee, express or implied, regarding the products or services described herein or their use, performance, merchantability or fitness for a particular purpose. Individual results may vary. All sales are governed by our terms and conditions, which are available upon request. We reserve the right to modify or improve the designs or specifications of our products at any time without notice. Responsibility for proper selection, use and maintenance of any product or service remains solely with the purchaser and end user.

