

Echotel® Model 335

Installation and Operating Manual



*Non-Contact
Ultrasonic Transmitter
For Level, Volume,
and Open Channel Flow
Measurement*

Read this Manual Before Installing

This manual provides information on the Echotel Model 335 Non-Contact Ultrasonic Transmitter. It is important that all instructions are read carefully and followed in sequence. Detailed instructions are included in the Installation section of this manual.

Conventions Used in this Manual

Certain conventions are used in this manual to convey specific types of information. General technical material, support data, and safety information are presented in narrative form. The following styles are used for notes, cautions, and warnings.

Notes

Notes contain information that augments or clarifies an operating step. Notes do not normally contain actions. They follow the procedural steps to which they refer.

Cautions

Cautions alert the technician to special conditions that could injure personnel, damage equipment, or reduce a component's mechanical integrity. Cautions are also used to alert the technician to unsafe practices or the need for special protective equipment or specific materials. In this manual, a caution box indicates a potentially hazardous situation which, if not avoided, may result in minor or moderate injury.

Warnings

Warnings identify potentially dangerous situations or serious hazards. In this manual, a warning indicates an imminently hazardous situation which, if not avoided, could result in serious injury or death.

Safety Messages

Follow all standard industry procedures for servicing electrical equipment when working with or around high voltage. Always shut off the power supply before touching any components.

WARNING! Explosion hazard. Do not connect or disconnect equipment unless power has been switched off or the area is known to be non-hazardous.

Low Voltage Directive

For use in Installation Category II, Pollution Degree 2. If equipment is used in a manner not specified by the manufacturer, protection provided by the equipment may be impaired.

Notice of Trademark, Copyright, and Limitations

Magnetrol & Magnetrol logotype, and Echotel are registered tradenames of Magnetrol International, Incorporated.

Copyright © 2011 Magnetrol International.
All rights reserved.

Performance specifications are effective with date of issue and are subject to change without notice. Magnetrol reserves the right to make changes to the product described in this manual at any time without notice. Magnetrol makes no warranty with respect to the accuracy of the information in this manual.

Warranty

All Magnetrol electronic level and flow controls are warranted free of defects in materials or workmanship for one full year from the date of original factory shipment.

If returned within the warranty period; and, upon factory inspection of the control, the cause of the claim is determined to be covered under the warranty; then, Magnetrol will repair or replace the control at no cost to the purchaser (or owner) other than transportation.

Magnetrol shall not be liable for misapplication, labor claims, direct or consequential damage or expense arising from the installation or use of equipment. There are no other warranties expressed or implied, except special written warranties covering some Magnetrol products.

Quality Assurance

The quality assurance system in place at Magnetrol guarantees the highest level of quality throughout the company. Magnetrol is committed to providing full customer satisfaction both in quality products and quality service.

The Magnetrol Corporate quality assurance system is registered to ISO 9001 affirming its commitment to known international quality standards providing the strongest assurance of product/service quality available.





Echotel Model 335

Non-Contact Ultrasonic Transmitters

Table of Contents

1.0 Installation	
1.1 Unpacking	4
1.2 Mounting and Application Considerations	4
1.2.1 Position	4
1.2.2 Orientation	4
1.2.3 Temperature	4
1.2.4 Obstructions	5
1.2.5 Standpipes	5
1.2.6 Foam	5
1.2.7 Vapors	5
1.2.8 Wind	5
1.2.9 Open Channel Flow Measurement	5
1.3 Electrostatic Discharge (ESD) Handling Procedure ..	6
1.4 Wiring	6
1.5 Configuration	7
1.5.1 LCD Module	7
1.5.2 <i>QuickSet Configuration</i>	9
1.5.3 Basic Functions	10
1.5.4 Setting <i>QuickSet Configuration</i> Parameters ..	10
1.6 Complete Configuration	12
1.6.1 Measurement Configuration Parameters	13
1.6.2 mA Current Output Settings	19
1.6.3 SPDT Relay Configuration	20
1.6.4 Performance Enhancement	21
1.6.5 Volume Configuration	26
1.6.6 Open Channel Flow Configuration	27
1.6.7 Linearization Table	31
1.6.8 Information Parameters	32
1.6.9 Open Channel Flow Head and Totalizers ..	34
1.6.10 Output Test Parameters	34
1.6.11 Simulation Mode	35
1.6.12 Additional Software Parameters	36
1.7 Diagnostic Error Codes	37
2.0 Reference Information	
2.1 Description	38
2.2 Theory of Operation	38
2.3 Performance	38
2.4 Measurement Range Calculations	39
2.5 Velocity of Sound in Gases other than Air	40
2.6 Specifications	40
2.6.1 Performance	40
2.6.2 Transmitter	41
2.6.3 Transducer	41
2.6.4 Physical	42
2.7 Model Number	42
2.8 Configuration Parameter Worksheet	43

1.0 Installation

Caution: If equipment is used in a manner not specified by manufacturer, protection provided by equipment may be impaired.

1.1 Unpacking

Unpack the instrument carefully. Inspect all units for damage. Report any concealed damage to carrier within 24 hours. Check the contents of the packing slip and purchase order. Check and record the serial number for future reference when ordering parts.

Caution: Do not discard the shipping container until all parts are checked.

1.2 Mounting and Application Considerations

Caution: Unit should only be hand-tightened (4–12 ft-lbs) into the process connection. The wrench flats should only be used when removing the unit. Overtightening will cause transducer errors and will void the warranty.

There are several application considerations that should be evaluated prior to installing a non-contact ultrasonic transmitter. The next few pages should be read thoroughly to ensure that the Model 335 will perform as expected in the given application. *Section 2.4, Measurement Range Calculations*, provides measurement range calculations that should be used to determine the maximum potential range in difficult applications.

1.2.1 Position

The optimum mounting position of the Model 335 is between $\frac{1}{2}$ of the radius and $\frac{2}{3}$ diameter of the (cylindrical) tank. This will position the unit to minimize any interference that the 7° beam (3.5° half angle) has with the tank walls or any agitator blades that exist in the tank. Refer to beam angle figure on page 38.

1.2.2 Orientation

The face of the transducer must be parallel to the liquid surface within $\pm 2^\circ$ to 3° .

1.2.3 Temperature

Ensure that the transmitter will be protected against overheating by direct sunshine. When the unit will be subjected to severe direct sun, the use of a sunshade is recommended.

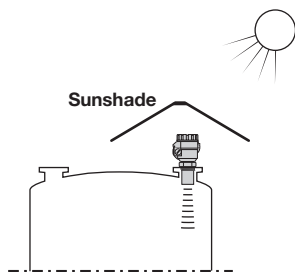
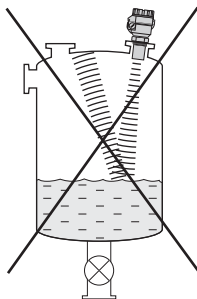
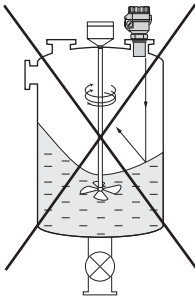
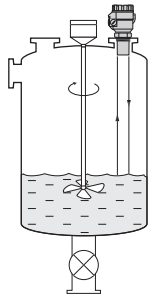
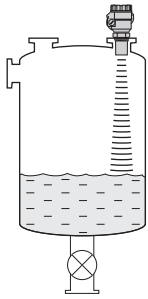

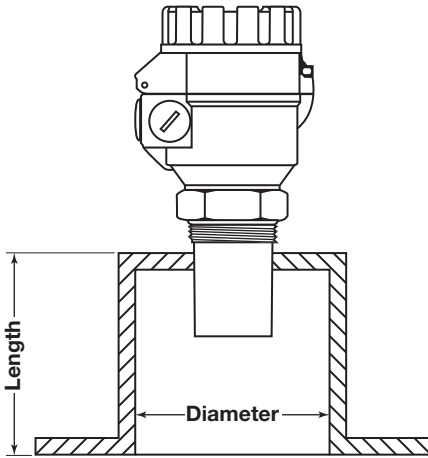
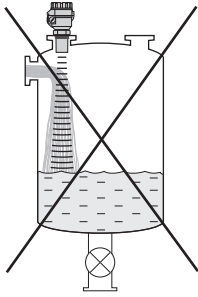

Standpipe Length	Minimum Diameter
6" (150 mm)	3" (75 mm)
8" (200 mm)	3" (75 mm)
10" (250 mm)	4" (100 mm)
12" (300 mm)	5" (125 mm)
14" (350 mm)	5" (125 mm)

1.2.4 Obstructions

Ensure that no obstacles (e.g., fill pipes, ladders, bracing members, thermometers, etc.) protrude into the ultrasonic beam. Although one fixed object in the tank can be blocked out by appropriate programming, it is advised to avoid these obstructions.

1.2.5 Standpipes

In applications where the material level may come into the deadband, the transducer must be mounted in a standpipe. Refer to *Section 1.6.1, Measurement Configuration Parameters, P05: Deadband* for deadband value. The inner rim of the standpipe must be smooth and free of burrs. The minimum diameter for a given length of standpipe is shown at left.

1.2.6 Foam

Foaming of the liquid surface may render ultrasonic level measurement impossible. If possible, a mounting location should be found, where foaming is at a minimum. Another alternative is to install the transducer in a stilling well that extends below the lowest level to be measured in the tank.

1.2.7 Vapors

Closed tanks that contain chemicals or other liquids that create vapors, may severely reduce the maximum measuring range. Refer to the *Section 2.4, Measurement Range Calculations* for more information.

1.2.8 Wind

Intensive moving of the air in the vicinity of the ultrasonic beam is to be avoided. A strong wind may not allow the return echo to be received by the ultrasonic transducer.

1.2.9 Open channel flow measurement

For the best accuracy, install the transducer as close as possible above the expected maximum water level in the flume or weir.

Install the Model 335 upstream of the flume throat or weir crest in the location defined by the manufacturer of the primary measuring device. The unit should also be aligned with the longitudinal axis of the flume or weir.

1.3 Electrostatic Discharge (ESD) Handling Procedure



Magnetrol electronic instruments are manufactured to the highest quality standards. These instruments use electronic components that may be damaged by static electricity present in most work environments. The following steps are recommended to reduce the risk of component failure due to electrostatic discharge.

Ship and store circuit boards in anti-static bags. If an anti-static bag is not available, wrap the board in aluminum foil. Do not place boards on foam packing materials.

Use a grounding wrist strap when installing and removing circuit boards. A grounded workstation is recommended.

Handle circuit boards only by the edges. Do not touch components or connector pins.

Make sure that all electrical connections are completely made and none are partial or floating. Ground all equipment to a good, earth ground.

1.4 Wiring

Caution: Power must be switched off before wiring the unit.

OBSERVE ALL APPLICABLE ELECTRICAL CODES AND PROPER WIRING PROCEDURES.

Caution: Terminal blocks must be removed with needle nose pliers. Forcing them out with a screwdriver will cause damage and void the warranty.

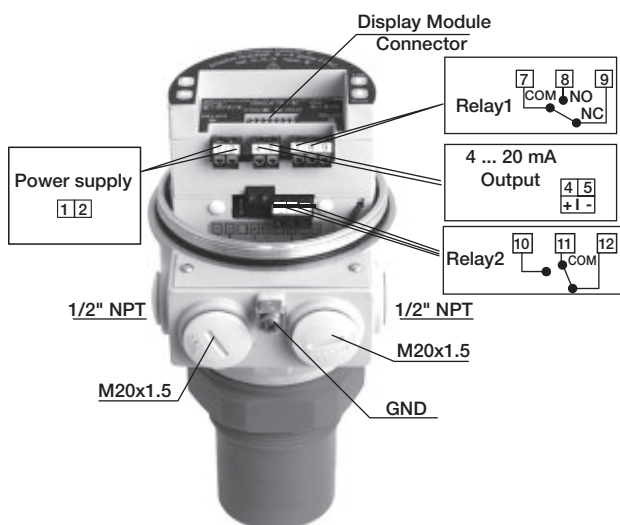

1. Unscrew the housing cover and remove the LCD module to access the removable terminal blocks (TB) position 1–9.
2. Use of 16–22 AWG wire is recommended.
3. The 4–20 mA signal cable should be separated from the supply voltage and relay cabling. Using a different conduit opening is recommended for the 4–20 mA cable.
4. TB 1/2 is used for the 85 to 255 VAC (Model # 335-AA1A-G5P) or 20 to 28 VDC (Model # 335-AD1A-G5P) supply voltage.
5. Terminals 4 (+) and 5 (–) connect the 4–20 mA signal.
6. Use the wiring diagram at left to terminate the relay wires. TB 7/8/9 is a 3-amp SPDT relay. TB 10/11/12 is a 1-amp SPDT bistable relay. A bistable (remanent) relay does not return to rest upon loss of power.

1.5 Configuration

There are two methods of configuring the Echotel Model 335 transmitter:

1. QuickSet Configuration that allows an extremely basic level application configuration.
2. Complete Configuration which is used for most level applications, and any volume or open channel flow configuration.

1.5.1 LCD Module

The LCD module can be used to set any of the configuration parameters used with the 335 transmitter. The LCD module can also be removed from the transmitter to configure other 335 transmitters, or as a precautionary measure to avoid unauthorized changes to the configuration data. It is not necessary to power down the 335 prior to removing or replacing the LCD module. The 335 is fully functional without the plug-in LCD module.

The LCD module consists of a bar graph that indicates echo strength or level as a percentage of span, and a custom graphics display that shows all configuration, measurement, and diagnostic data. The symbols below are used in the LCD module:

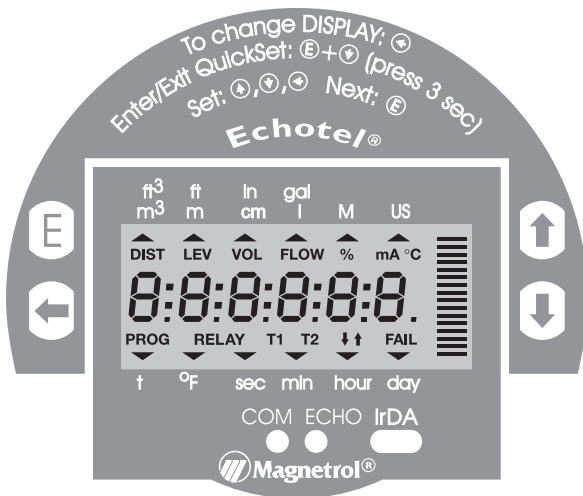

- DIST** = Distance from the face of the transducer to the liquid surface
- LEV** = Level measurement from the bottom of the vessel
- VOL** = Volume of liquid in the vessel
- FLOW** = Flow measurement in the flume or weir
- PROG** = Programming mode (transmitter is being programmed)
- RELAY** = Relay is energized
- T1** = Displays the volume in the resettable totalizer
- T2** = Displays the volume in the non-resettable totalizer
- FAIL** = A diagnostic failure has been detected
- ↑ = Indicates increasing level in the vessel
- ↓ = Indicates decreasing level in the vessel
- ↕ = Indicates stable level in the vessel

The middle row of the LCD module consists of a 6-digit alphanumeric display of all data. Engineering units for the numeric data are printed above and below the LCD. Two pointers are used to indicate which units pertain to the display that is currently being viewed. The pointer in the upper right portion of the module indicates:

- M = Metric (numbers displayed can be either cubic meters, meters, cm, or liters)
- US = US (numbers displayed can be either cubic feet, feet, inches, or gallons)

Programming with the LCD module involves pressing one or two (simultaneously) of the four push buttons. The push buttons can also be used to access data while in the normal operating mode as shown below.

<i>Push Button</i>	<i>While Configuring Unit</i>	<i>In Normal Mode</i>
ENTER	<i>QuickSet Configuration:</i> saves the displayed data and proceeds to the next parameter register <i>Complete Configuration:</i> switches between the parameter value and the parameter register	Not used
NEXT	Shifts the blinking digit one position to the left	Switches between measurement modes (level, distance, volume, flow)
UP	Used to increase the value of the blinking digit	Displays the temperature reading
DOWN	Used to decrease the value of the blinking digit	Displays the current (mA) reading

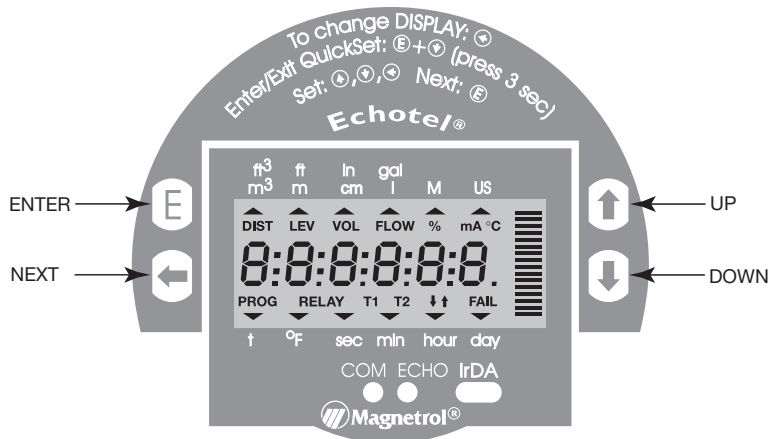

There are three LEDs in the LCD module. The ECHO LED will be continuously lit when the 335 is receiving a good signal back from a stable level surface. The ECHO LED will blink when it is receiving a signal back from a decreasing or increasing level surface. When the ECHO LED is not lit the 335 has lost the signal, and cannot make a reliable measurement. The IrDA LED is only used at the factory for software upgrades. The COM LED is not used.

1.5.2 QuickSet Configuration



Some very basic level applications can be easily set-up by using the *QuickSet Configuration*. Open channel flow, volume, or more detailed level configuration is performed by using *Section 1.6, Complete Configuration*. The following eight parameters are set by using *QuickSet*:

1. Engineering units of feet or meters (other units can be selected by using the Complete Configuration)
2. Range (maximum measuring distance)
3. 4 mA setpoint
4. 20 mA setpoint
5. Failsafe indication of 3.6 mA, 22 mA, or “Hold”
6. Damping time of up to 60 seconds
7. Level value that will energize the SPDT relays
8. Level value that will de-energize the SPDT relays

The Model 335 is shipped with “Level” as the default for the LCD, bargraph, and mA current output. The factory default values for the *QuickSet Configuration* data are:

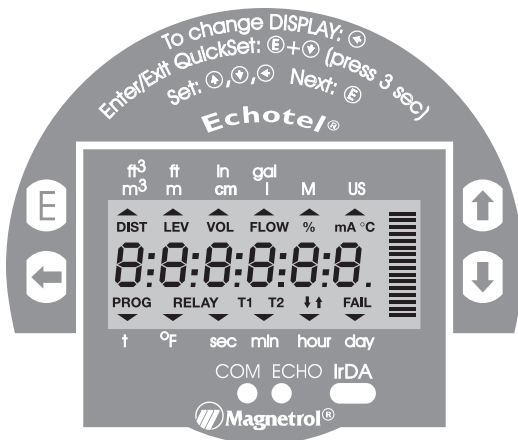
1. Engineering units of feet
2. Range of 26 feet
3. 4 mA set at 0 feet
4. 20 mA set at 24.8 feet (Range – 14" deadband)
5. Failsafe set for “Hold” last value
6. Damping time of 60 seconds
7. Relay energize value of 0 feet
8. Relay de-energize value of 0 feet



Holding the  and  buttons down at the same time for 3 seconds allows entry into the *QuickSet* menu. The instructions for entering or exiting *QuickSet* are also printed on a label under the housing cover, just above the LCD module.

1.5.3 Basic Functions

The commands below set the basic functions of the 335 transmitter during *QuickSet Configuration*.

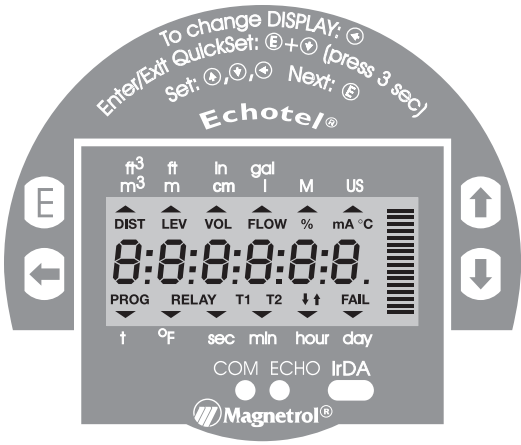

Push Button Keys	Function
ENTER + DOWN (press for 3 seconds)	Enter or exit <i>QuickSet Configuration</i> menu
UP or DOWN	Increase or decrease value of blinking digit, or scroll up/down to change parameters
NEXT	Move the blinking digit to the left (to change its value)
ENTER	Saves the value currently being displayed and moves to the next <i>QuickSet</i> parameter

Shown below are some additional commands that can be used while in the *QuickSet* menu. Keystrokes for displaying the "Get Level" command described below are also printed on the label just below the LCD module. The "Get Level" command is especially useful if the level or distance parameter is unknown, and the liquid is at the proper height in the tank.

Push Button Keys	Function
UP + DOWN (press for 3 seconds)	Accesses the "Get Level" screen to display the actual measured level or distance currently being measured by the Model 335 transmitter
NEXT + UP	Reset parameter back to the previously saved value
NEXT + DOWN	Reset the currently displayed parameter back to the factory default value

1.5.4 Setting *QuickSet Configuration* Parameters

The table on page 11 shows how to set all eight of the *QuickSet Configuration* parameters.







NOTE: Current output can also be programmed for inverted operation: 4 mA = 100% (Full), 20 mA = 0% (Empty)

NOTE: If a parameter value is not accepted by the LCD module, the existing parameter value will keep blinking. This is due to:

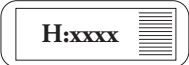
1. The value is out of range (example would be trying to enter a range value larger than 26.00 feet)
2. The parameter value is not valid for this screen

NOTE: If no push buttons are pressed for 30 minutes, the transmitter will automatically return to the measurement mode, and operate with the parameters entered during the last completed programming.

To enter or exit the *QuickSet Configuration* menu press ENTER + DOWN keys for 3 seconds. The LCD module should now display the level of the liquid media.

Display	Actions
	<p>Application xx: Select “EU” (European) for metric or “US” for US engineering units by using UP / DOWN keys yy: Select “LI” for liquid or “So” for solids level applications (Note: Solids are not currently supported) Factory Default Value: US and LI After selecting the desired value press the ENTER to save the value and proceed to the next parameter.</p>
	<p>H: xxxx Range (maximum measuring distance) Distance between transducer face and bottom of the tank. Manual Entry: Set value using UP / DOWN / NEXT keys and save it with the ENTER key. Automatic Entry: Use the “Get Level” function (UP + DOWN) to obtain the actual measured value in the tank, or to a fixed target, i.e., wall. Press ENTER to save value and proceed to the next parameter Note: The “Get Level” feature only works if the Echo LED is lit. Factory Default Value: 26 feet (maximum range)</p>
	<p>4: xxxx Level value assigned to 4 mA current output Manual Entry: Set level value using UP / DOWN / NEXT keys and save it with the ENTER key. Automatic Entry: Use the “Get Level” function (UP + DOWN) to display the actual measured value with level in the tank or to a fixed target. Press ENTER to save value and proceed to the next parameter. Note: The “Get Level” feature only works if the Echo LED is lit. Factory Default Value: 0 feet (0% value or, empty tank)</p>
	<p>20: xxxx Level value assigned to 20 mA current output Manual Entry: Set level value using UP / DOWN / NEXT keys and save it with the ENTER key Automatic Entry: Use the “Get Level” function (UP + DOWN) to display the actual measured value with level in the tank or to a fixed target. Press ENTER to save value and proceed to the next parameter. Note: The “Get Level” feature only works if the Echo LED is lit. Factory Default Value: 24.8 feet (100% full tank, this value is range minus the deadband of 14”)</p>
	<p>Er is the failsafe Error indication value. Select “Hold”, “3.6” mA or “22.0” mA by using the UP / DOWN keys, and press ENTER to save the value and proceed to the next parameter. Factory Default Value: "Hold" last mA current value</p>
	<p>dt is the damping time (in seconds) required for the level application Select 0, 3, 6, 10, 30, or 60 seconds by using the UP / DOWN keys) and press ENTER to save it as above. Factory Default Value: 60 seconds</p>
	<p>rE is the level value that will energize the SPDT relay. When the level in the tank exceeds this value the relay will energize. Select the desired value by using the UP / DOWN / NEXT keys and save it with the ENTER key. Factory Default Value is 00.00</p>
	<p>rd is the level value that will de-energize the SPDT relay. When the level in the tank gets below this value the relay will de-energize. Select the desired value by using the UP / DOWN / NEXT keys and save it with the ENTER key. Factory Default Value is 00.00</p>

1.6 Complete Configuration

Open channel flow, volume, and more advanced level applications are configured using the Complete Configuration Menu.

To enter (or exit from) this menu press the ENTER + NEXT keys simultaneously for 3 seconds. While programming the 335 in this menu, the display will indicate:

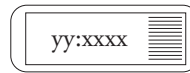
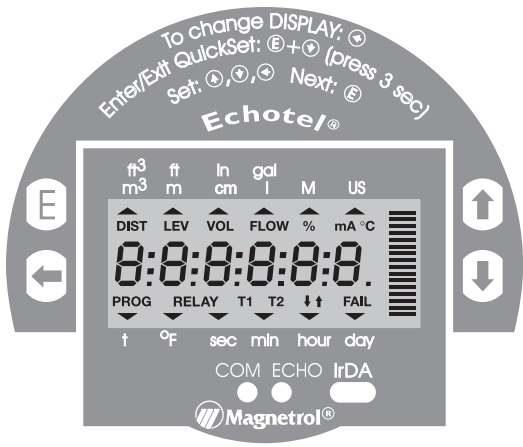

yy is the Parameter Register
xxxx is the Parameter Value

NOTE: While in the programming mode, the 335 will continue to measure level based on pre-existing configuration parameters. New configuration parameters will be used after exiting the programming mode.

The following keystrokes can be used while programming in the Complete Configuration Menu:

Keystrokes	Action when Parameter Register is blinking	Action when Parameter Value is blinking
ENTER + NEXT (press for 3 seconds)	Enter or exit Complete Configuration Menu	Nothing – Parameter Register must be blinking to enter or exit the Complete Configuration menu
UP / DOWN	Scroll up or down Parameter Registers	Increase or decrease Parameter Value
ENTER	Switches blinking digit to the Parameter Value side of the display	Saves changes to the Parameter Value and switches back to the Parameter Register side of the display
NEXT	Move blinking digit one position to the left	Move blinking digit one position to the left
NEXT + UP (press for 3 seconds)	Cancel programming changes made to all registers and revert back to previous parameter values. Must press for 3 seconds until CANCEL is displayed in LCD.	Cancel programming changes made to all registers and revert back to previous parameter values. Must press for 3 seconds until CANCEL is displayed in LCD.
NEXT + DOWN	Resets entire unit back to the Factory Default Values. Since this will reset all parameters, "LOAD" will appear on the display: <ul style="list-style-type: none"> Press ENTER to confirm this reset Press any other key to CANCEL and escape The only exception is clearing TOT1 (Parameter P77)	Displays the default of the Parameter Value <ul style="list-style-type: none"> Press ENTER to save the default value Press UP / DOWN to change to another value

1.6.1 Measurement Configuration Parameters

The following pages explain how to configure each of the parameters in the *Complete Configuration*. Since some of the Parameter Registers are not used by the 335, several parameters are skipped. Refer to *Configuration Parameter Worksheet, Section 2.8*, for a complete listing of all the parameters.

Many of the registers have multiple configurations within the same register. For example, P00 below is used to select Metric or US, the engineering units, and the application. Since some registers only have one configuration (“a”), and some have more than one, the digit order for each register is d, c, b, a.

P00: - cba Application and Engineering Units
Factory default value for P00 is: 000

c	Measuring System
0	Metric
1	US

b	Engineering Units (see “c”)	
	English	Metric
0	feet	meter
1	inch	cm

a	Application*	Display Indication
0	Liquid level measurement	“Li”
1	Solid level measurement	“So”

*NOTE: The 335 does not support solids level measurement at this time.

P01: - ba Bar Graph and Measurement Mode

Factory default value for P01 is: 11

The bar graph can be set at “0” to indicate the strength of the return echo, or to “1” to indicate the mA current output as a percentage of the span.

The Measurement Mode configures the 335 for the desired application. If “0” is selected the only measurement value that will be displayed is distance. Selecting other values will allow distance, level, and volume or flow measurements to be displayed alternatively by using the NEXT key in the operating mode. The value of “a” in P01 also determines the values of registers P40 through P48. If “3” or “4” is selected these values will be volume parameters, and if “5” is selected these values will be flow parameters.

b	Bar Graph Indication
0	Echo strength
1	Current output

a	Measurement Mode	Displayed Measurements
0	Distance	DIST
1	Level	LEV, DIST
2	Level in percentage	LEV%, LEV, DIST
3	Volume	VOL, LEV, DIST
4	Volume in percentage	VOL%, VOL, LEV, DIST
5	Flow	FLOW, T1, T2, LEV, DIST

NOTE: Tank or flume/weir dimensions must be entered prior to displaying volume or open channel flow values. Programming for these parameters begins with P40.

P02: - cba Calculation Units

Factory default value for P02 is: 000

Engineering units for volume are selected in “b”, and units for open channel flow are selected using “b” and “c”.

Metric or US for “b” is selected by the value of “c” in P00.

The volume can also be displayed in units of weight by setting “b” and entering the density of the fluid in P32.

The value of “a” determines the temperature units when the UP key is pressed in the operating mode.

c	Time
0	Sec
1	Min
2	Hour
3	Day

b	Volume		Weight (set also P32)		Open Channel Flow	
	US	Metric	US	Metric	US	Metric
0	ft ³	m ³	lbs (pounds)	–	ft ³ /time	m ³ /time
1	gallons	liter	tons	tons	gallons/time	liter/time

a	Temperature
0	° C
1	° F

**P03: - a Displayed Values
(Rounding & Decimal Position)**
Factory default value for P03 is: 0

Level and distance applications do not use P03 since the biggest number that can be displayed on the 6 digit LCD is 800 cm, or 315 inches. Displayed values for volume and open channel flow applications can become quite large, and for this reason it may be easier to read the LCD if rounding is used.

Rounding

a	Displayed Value Steps
0	1 = no rounding
1	2
2	5
3	10
4	20
5	50

Fractional inch changes in a large tank will cause rapid fluctuations in the LCD when measuring volume. Turbulence in a tank or open channel flow element may also cause unwanted display fluctuations. Rounding values (2, 5, 10, 20, 50) represent the numeric steps the calculated value will change in the last one (or two) digit(s).

Examples:

P03 = 1 steps by 2: 1,000 ⇒ 1,002 ⇒ 1,004 ⇒ 1,006

P03 = 5 steps by 50: 1,000 ⇒ 1,050 ⇒ 1,100 ⇒ 1,150

Displayed VOL or FLOW

Displayed Value	Decimal Position
00.000 – 9.999	x.xxx
10.000 – 99.999	xx.xx
100.000 – 999.999	xxxx.
1000.000 – 9999.999	xxxxx.
100000.000 – 99999.999	xxxxxx.
1 million – 9.99999*10 ⁹	x.xxxx : e (exponential form)
over 1*10 ¹⁰	(overflow) Err4

As the numeric display becomes larger in volume and open channel flow applications, the decimal point is automatically shifted over to accommodate the larger numbers in the 6 digit LCD.

Values over one million will be displayed in exponential format where the value (e) represents the exponent. Once over the value of 1x10¹⁰ Err4 (overflow) will be displayed.

P04: Range

Range is the maximum measuring distance. For level and volume applications this is the distance from the face of the transducer to the bottom of the tank.

$LEVEL = P04 \text{ (programmed)} - DISTANCE \text{ (as measured from transducer face to liquid surface)}$

Since the measurement accuracy of the 335 depends on a correct value of P04, it is critical to know the exact distance between the face of the transducer and the bottom of the tank. If this value is unknown, it can be set using the "GET LEVEL" command. Make sure the tank is empty, or at the 0% level mark. While in P04, press the ENTER key so that the four digit parameter is blinking. Press the UP + DOWN keys simultaneously for 3 seconds, and the unit will display the measured distance between the transducer face and the bottom of the tank. If satisfied with the displayed value press the ENTER key to accept this as the range value.

The factory default range value of 26 feet (8 meters) can be displayed while in P04. Press the ENTER key until the four-digit parameter is blinking, and then simultaneously press the NEXT + DOWN keys. The default value will be shown. Press the ENTER key to accept this value, or input the appropriate value for the specific application.

Range values will be displayed as shown.

Engineering Unit	Display Format
m	x.xxx or xx.xx
cm	xxx.x
ft	xx.xx or xxx.x
inch	xxx.x

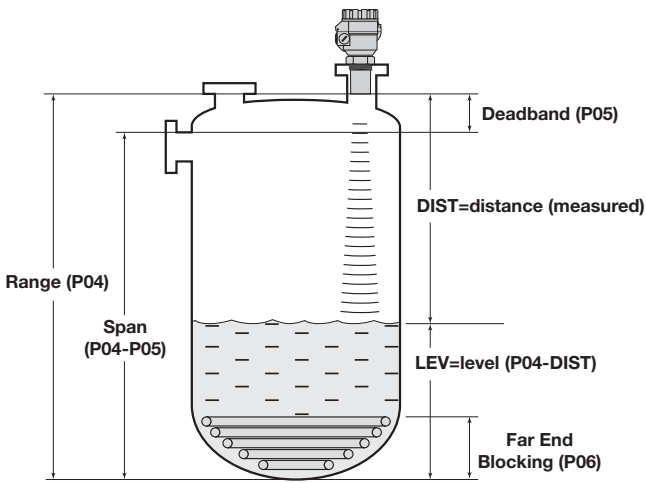

P05: Deadband

Factory default value for P05 is: 14.0 inches

Non-contact ultrasonic transmitters require a “deadband” or “blind space” between the face of the transducer and the maximum liquid level. The minimum deadband for the Model 335 is 14" (35 cm), as shown in the drawing at left. The 335 will not process any ultrasonic signals within the deadband. For this reason, it may be necessary to mount the transducer in a standpipe to enable the 335 to measure all the way to the top of a tank. Refer to *Section 1.2.4, Standpipes*, for information on mounting in standpipes.

For most applications the factory default value of 14" (35 cm) is used, which allows the unit to have the smallest possible deadband. Entering a value larger than 14" (35 cm) allows the unit to block out any false echoes originating from the bottom rim of a standpipe, or from any object protruding into the ultrasonic beam close to the transducer. Since the 335 will not measure any value inside the deadband, the full tank (usually 20 mA) value will need to be adjusted if the deadband value is changed.

P06: Far-end Blocking

Factory default value for P06 is: 00

Level or Volume Applications

Far end blocking is used to ignore false reflections caused by objects at the bottom of the tank. This can be helpful with tanks that have heaters, or other objects at the bottom of the tank, and also with conical bottom tanks where level measurement may not be necessary below a preset level.

P06 is entered as the distance from the bottom of the tank to top of the interfering object. If the liquid level falls below this preset level, and enters the far end blocking section of the tank:

1. “**Sub 0**” will be shown in the LCD
2. “**FAIL**” will blink on/off
3. The mA output will hold the value that corresponds to the far end blocking level

Open Channel Flow Applications

Far end blocking is used in open channel flow applications to force a zero flow value when the level is below the chosen value. This allows the totalizer to stop recording flow when the level drops below the preset value. If the liquid level in the flume or weir falls below this value the 335 will:

1. Indicate “No Flow” on the LCD module
2. Hold last valid mA current value

NOTE: When the liquid level is above the far end blocking section the calculation of level, volume, or open channel flow is based on the programmed tank dimensions; therefore, the measured or calculated process values are not influenced by the far end blocking value.

NOTE: P07, P08, and P09 are not currently used with the Model 335 transmitter.

1.6.2 mA Current Output Settings

P10: 4 mA current output value

P11: 20 mA current output value

The mA current output values are calculated according to the Measurement Mode that was selected in P01. If LEV was selected, then the 4 & 20 mA will be in level units, if VOL was selected then use volume units, and if FLOW was selected then use flow units. For % measurements (LEV or VOL) the 4 mA and 20 mA values are entered in the relevant engineering units of LEV (ft, in, m, or cm) or VOL (gal, ft³, m³, or liters).

Though P10 and P11 are usually set with 4 mA at the bottom of the tank and 20 mA at the top, they can be reversed with 20 mA at the bottom and 4 mA at the top.

P12: -a Failsafe Indication

Factory default value for P12 is: 0

The Model 335 continuously performs diagnostic checks on the electronics and transducer, and confirms that the unit has been configured properly. Refer to *Section 1.8, Diagnostic Error Codes*, for a listing of all the errors codes that can be displayed by the 335 transmitter. P12 is used to set the desired mA output value if any faults are detected. The fail-safe mA values shown below are in accordance with the NAMUR NE 43 standards.

c	Fault Values
0	Hold last value
1	3.6 mA
2	22 mA

1.6.3 SPDT Relay Configuration

P13: - a Relay Operation

Factory default value for P13 is: 2

The 3-amp SPDT relay can be configured to be a wide differential level alarm, a diagnostic alarm for echo loss indication, or a pulsed relay for remote flow totalization.

The 1-amp SPDT relay mimics the state of the 3-amp SPDT, but does not change state in the event of a power loss.

a	Relay Function	Also Set
0	Set register 13 to a value of 0 to use the relay as a level alarm. The relay is energized when the level exceeds the value set in P14, and de-energized when the level falls under the value set in P15.	P14 and P15 Note: Minimum hysteresis is .75" (2 cm) between P14 and P15
1	Setting register 13 to a value of 1 makes the relay energize during an Echo Loss.	Not applicable
2	Setting register 13 to a value of 2 makes the relay de-energize during an Echo Loss.	Not applicable
3	Remote totalization can be used in open channel flow applications. Setting register 13 to a value of 3 will generate a 140 msec pulse every 1, 10, 100, 1,000 or 10,000 volume units according to P16.	Set P16 as follows: P16= 0: 1 volume units P16= 1: 10 volume units P16= 2: 100 volume units P16= 3: 1,000 volume units P16= 4: 10,000 volume units

P14: _ _ _ Level setpoint value that will energize the relay

Factory default value for P14 is: 0

P15: _ _ _ Level setpoint value that will de-energize the relay

Factory default value for P15 is: 0

P16: _ _ _ Pulse rate for remote totalization (see P13 above)

Factory default value for P16 is: 0

NOTE: Volume units for P16 are in accordance with the value set in P02 and P00. Choices are gallons or ft³ for US, liters or m³ for metric.

1.6.4 Performance Enhancement

Registers 20 through 33 can be used to enhance the performance of the Model 335 in specific applications.

P20: - - - a Damping

Factory default value for P20 is: 5 (60 seconds).

Parameter register 20 can be used to reduce undesired fluctuations of the display and output, and enhance performance in turbulent applications.

a	Damping time (seconds)	Little to no turbulence/agitation	Moderate to heavy turbulence/agitation
0	no filtering	only used for testing purposes	
1	3	acceptable	not recommended
2	6	recommended	acceptable
3	10	recommended	recommended
4	30	recommended	recommended
5	60	recommended	recommended

P22: - - - a Dome top tank compensation

Factory default value for P22 is: 0.

Non-contact ultrasonic transmitters can occasionally receive two or more echoes when the transducer is mounted in the center of a domed top tank. If the transducer can not be positioned away from the center of the domed top, the 335 provides compensation to reduce the effects of multiple echoes.

a	Compensation	Situation
0	OFF	Use when the Model 335 can be mounted off center in the domed top tank
1	ON	Use when the Model 335 is mounted in the center of a domed top tank

P23: - - - a Register P23 is not used with the Model 335

Factory default value for P23 is: 0.

P24: - - - a Target tracking speed

Factory default value for P24 is: 0.

a	Tracking Speed	Application Conditions
0	Standard	For most applications
1	Fast	For fast changing level
2	Special	Used only in special applications. The measuring window (see P25) becomes inactive, and the 335 responds instantly to any target. This can be used for extremely fast target tracking, but is not recommended for level applications. Note: The maximum range is reduced in half when this is used.

P25: - - - a Echo selection within the measurement window

Factory default value for P25 is: 0.

Advanced digital signal processing within the 335 forms a measurement “window” around the echo that is reflected off the surface of the liquid. This measurement window determines the distance that is used to calculate the level, volume or open channel flow. A visual of this window is shown at left as it would be seen on an oscilloscope.

Some applications may have multiple echoes that result from false targets or noise within the vessel. Register P25 provides three different echo selection modes for the 335 to use in forming the measurement window around the proper signal.

a	Echo Selected	Application
0	Echo with the highest amplitude	This default value is used for most Model 335 applications.
1	First echo	For applications where false targets may create multiple echoes.
2	Largest echo	Not recommended unless advised by factory.

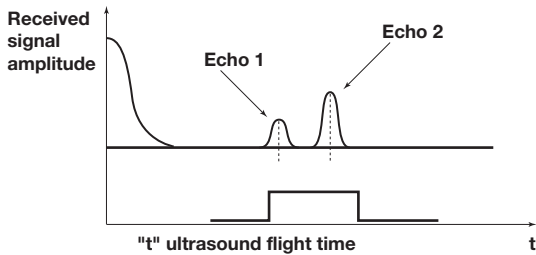

P26: (m/hr) Vessel fill rate

Factory default value for P26 is: 2000 m/hr (6562 ft/hr).

P27: (m/hr) Vessel drain rate Factory default value for P27 is: 2000 m/hr (6562 ft/hr).

Parameters P26 & P27 can be used to set the rate of filling or draining a vessel. Typical values for P26 & P27 are anywhere from 60 m/hr (200 ft/hr) to 2000 m/hr (6562 ft/hr). Entering fill and drain rate values can also provide additional protection against echo loss in applications involving vapors or turbulence. It is extremely important that the values of P26 & P27 not be smaller (slower) than the fastest possible filling/emptying rate of the specific application, or the ultrasonic signal will be lost.

P28 - - - a Echo loss error reporting

Factory default value for P28 is:

a	Echo loss error reporting mode	Conditions
0	Delayed	Initially, the delayed mode will hold the display and 4-20 mA output at their last value during an echo loss. If the echo loss continues for a period of time 10 seconds longer than the damping set in P20, then the display will change to "no ECHO" and the 4-20 mA output will change according to the "Error Indication Mode" set in P12.
1	None	The display and 4-20 mA output hold their last value until the echo loss clears and a valid echo is received by the 335.
2	Advance to full	If an echo loss occurs while the vessel is filling, the display and 4-20 mA value change to indicate a full vessel as configured in P04 and P05. The full vessel is indicated at the fill rate as preset in P26.
3	Immediate	During an echo loss, the display will immediately change to "no ECHO" and the 4-20 mA will change according to the "Fault Value" preset in P12.
4	Advance to empty	An echo loss may occur in completely empty vessels with a spherical or conical bottom due to deflection of the ultrasonic signal. If the echo is lost when the vessel is completely empty, the display and 4-20 mA will immediately change to indicate an empty vessel.

P29 **False target # 1**
Factory default value for P29 is: 0.0

P30 **False target # 2**
Factory default value for P30 is: 0.0

Up to two fixed objects in the tank can be blocked out if they are within the ultrasonic beam angle, and are creating false echoes. Measure the distance of the object from the face of the transducer, and enter this into P29 or P30.

P31 **Speed of sound through gas**
Factory default value for P31 is: 1,128 ft/sec (US units), or 343.8 m/sec (metric units)

NOTE: The default value should not be changed unless instructed to do so by the factory. Changing the default value of P31 will alter all measurements made by the Model 335.

Parameter P31 can be used if ultrasonic signal will be traveling through a vapor other than air. The default value of 1,128 ft/sec (343.8 m/sec) assumes that the ultrasonic signal will be traveling through air. Since the speed of sound is different in gases other than air, P31 allows an adjustment to be made for this difference. This parameter should only be used if the gas is homogenous throughout the tank. It should not be used if there are stratified layers of a gas in the tank. Refer to *Section 2.5, Velocity of Sound In Gases Other Than Air*, enter the new speed of sound in P31.

P32 **Specific gravity**
Factory default value for P32 is: 0.00

Entering a value other than the default of 0.00, will allow the 335 to display the weight of the material in the tank. Prior to displaying weight, the 335 must be configured for volume by following these steps:

1. Set the measurement mode for volume in P01.
2. Select the weight units in P02.
3. Configure the tank shape by entering values in P40 – P45.
4. Enter the density (specific gravity) value in P32.

After completing the above four steps, return to the measurement mode. The LCD will indicate VOL, but there will not be pointer at the ft³/m³ section of the LCD. Depending on the value entered in P02, the unit will display weight in either tons or pounds. When displaying tons, the LCD will have a triangle pointing to the “t” in the lower left side of the display. When displaying pounds, this pointer does not appear.

P33

Manual echo selection

Factory default value for P33 is: 0

NOTE: Manual echo selection should not be used unless instructed to do so by the factory. Changing the default value of P33 will alter all measurements made by the Model 335.

A "measuring window" is formed around the ultrasonic echo, as shown in the diagram below. The distance of the target is calculated from the speed of sound (P31), and the position of the measuring window.

P33 can be used if the 335 is selecting the wrong echo. An example of this could be when the correct echo reflected from the surface is much weaker than an interfering echo. This scenario is shown at left and below.

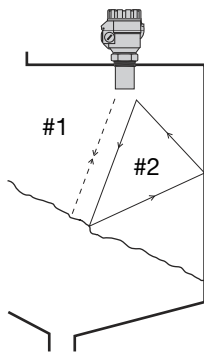

When the distance of the correct echo is entered in P33, the software will move the measuring window and calibrate itself to the proper echo. To determine the distance of the correct echo, either measure the distance with an appropriate device, or use the Echo Map information shown in P70, and enter this value in P33.

When the default value of P33 is changed, its value will continuously update with the proper echo position. Should power be lost to the transmitter, the 335 will restart the signal processing with the measuring window at the last updated position. To turn off Manual Echo Selection, simply reset P33 to zero.

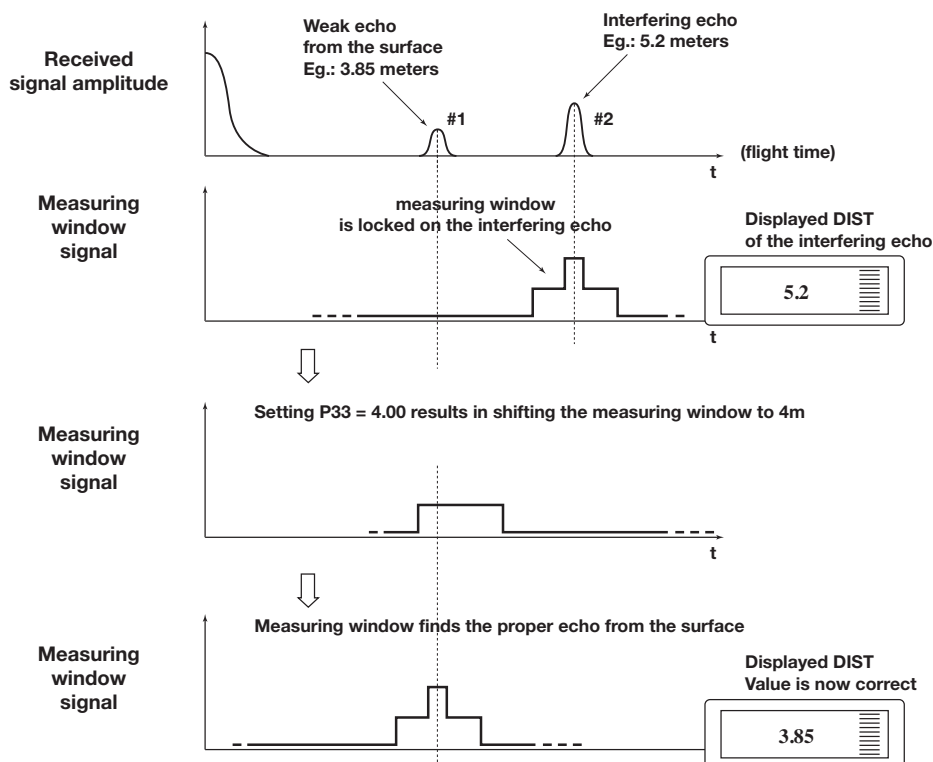

1.6.5 Volume Configuration

P40 Tank shape

Factory default value for P40 is: 00

Volume can be displayed by entering the shape and dimensions of the tank. Most common tank shapes can be configured by using parameters P40 to P45. The Model 335 also has a 32-point linearization table (P47 & P48) for unusual tank shapes that are not included in P40 to P45.

A two-digit number is entered into P40 to define the tank shape. P40 values of 01, 02, and 04 are simply entered as 01, 02, or 04. For b0 and b3 the value of "b" must also be selected from the shapes shown below.

P40	Tank Shape	Also to be set
b0	Vertical cylindrical tank with hemispherical bottom	P40(b), P41
01	Vertical cylindrical tank with conical bottom	P41, P43, P44
02	Vertical rectangular tank/silo (with or without chute)	P41, P42, (P43, P44, P45)
b3	Horizontal cylindrical tank	P40(b), P41, P42
04	Spherical tank	P41

P41 – 45 Tank dimensions

Factory default values for P41 – 45 are: 0.00

Enter appropriate dimension as shown below for the tank.

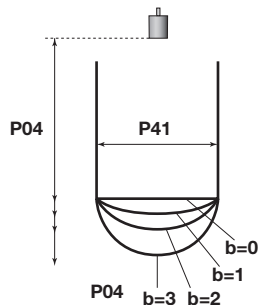

Vertical Cylindrical Tank with Hemispherical Bottom

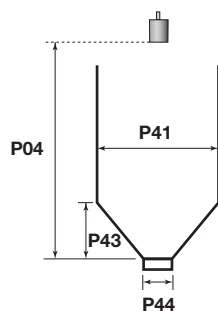

Vertical Cylindrical Tank with Conical Bottom

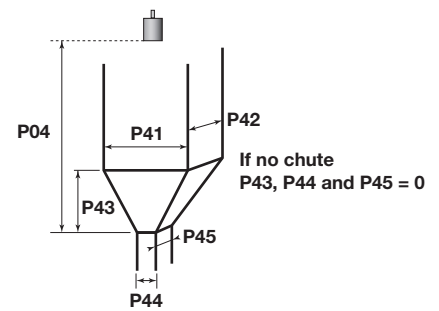

Vertical Rectangular Tank or Silo with or without Chute

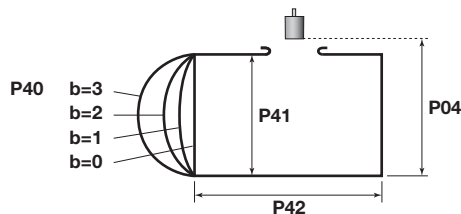

Horizontal Cylindrical Tank

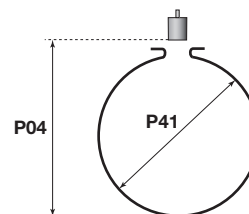

Spherical Tank

1.6.6 Open Channel Flow Configuration

P40 Primary flow elements, formulas, and data

Factory default value for P40 is: 00

Open channel flow measurement is accomplished by entering the type of primary flow element being used in P40, and the flume or weir dimensions in P41 through P45.

NOTE: P40 = 00 to P40 = 08 are not used for open channel flow applications.

P40	Primary element (Flume/Weir)	Also set:
09	Parshall flume (for any size Parshall flume)	P46, P42
10	Palmer-Bowlus flume (D/2)	P46, P41
11	Palmer-Bowlus flume (D/3)	P46, P41
12	Palmer-Bowlus flume (rectangular)	P46, P41, P42
13	Khafagi Venturi flume	P46, P42
14	Bottom-step weir	P46, P42
15	Rectangular weir without end contractions (suppressed)	P46, P41, P42
16	Trapezoidal weir	P46, P41, P42
17	Cipolletti trapezoidal (4:1) weir	P46, P42
18	V-notch weir (angle degrees entered in P42)	P46, P42
19	90° V-notch weir	P46
20	Circular weir	P46, P41
21	General flow formula: $Q[l/s] = 1000 * P41 * h^{P42}$, h [m]	P46, P41, P42

P41 – 45 Flume/weir dimensions

Factory default values for P41 – 45 are: 00

Enter the appropriate dimensions into P41 through P45 depending on which type of primary flow element is being used.

P46

Reference distance

Factory default value for P46 is: 0.00

Reference is the distance from the face of the transducer to the point where the flow rate becomes zero. This distance is different for each type of flume or weir. Measure the reference distance as shown in the following pages of flumes and weirs, and enter into P46.

Flume/Weir Dimensions

P40 = 00 to P40 = 08

P40 = 00 to P40 = 08 are not used for open channel flow applications.

P40= 09 Parshall flume

Parshall flume sizes are designated by their throat width. This width is entered in P42, using the same units as selected in P00. The reference distance must also be entered in P46.

The sensor is mounted over the flume at a distance of $\frac{2}{3}(A)$ behind the throat. The head (h) is also shown at left. When configuration is completed, the head value can be viewed in P76.

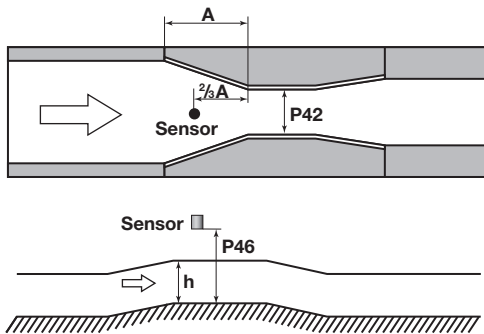

P40= 10 Palmer-Bowlus flume with (D/2)

Palmer-Bowlus flumes make a transition from a circular bottom section to a raised trapezoidal throat, and then transition back to the circular bottom section.

The range (P04) value is larger than the reference distance (P46) as shown at left. Enter values for P40, P41, P42, and P46. P41 is the conduit diameter.

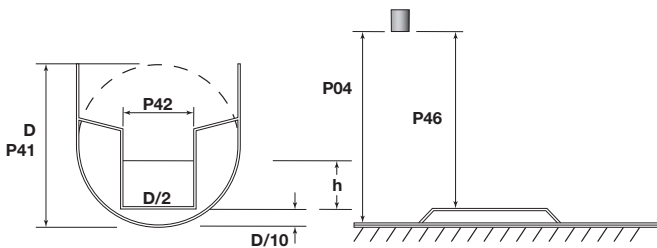

P40= 11 Palmer-Bowlus flume with (D/3)

Palmer-Bowlus flumes make a transition from a circular bottom section to a raised trapezoidal throat, and then transition back to the circular bottom section.

The range (P04) value is larger than the reference distance (P46) as shown at left. Enter values for P40, P41, P42, and P46. P41 is the conduit diameter.

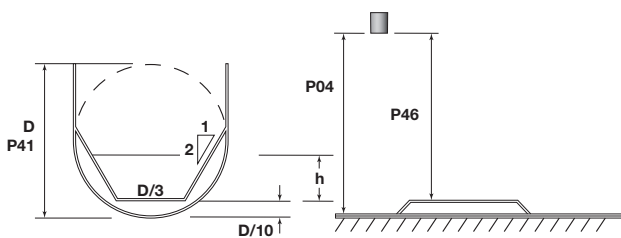

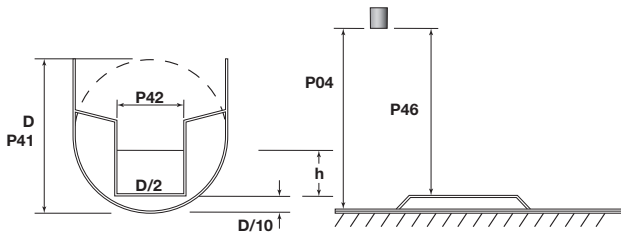

P40= 12 Palmer-Bowlus flume (rectangular)

Palmer-Bowlus flumes make a transition from a circular bottom section to a raised trapezoidal throat, and then transition back to the circular bottom section.

The range (P04) value is larger than the reference distance (P46) as shown at left. Enter values for P40, P41, P42, and P46. P41 is the conduit diameter.

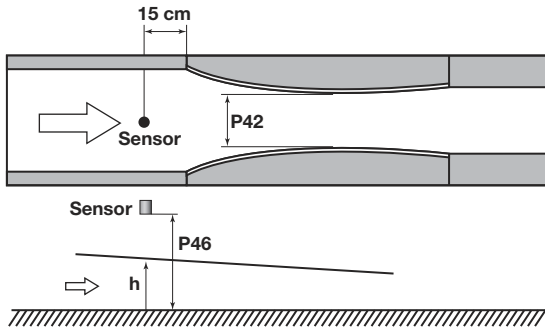

P40= 13 Khafagi Venturi flume

The flow through a Khafagi Venturi flume is derived from the following equation:

$$Q[\text{m}^3/\text{s}] = P42 * 1.744 * h^{1.5} + 0.091 * h^{2.5}$$

Enter the values for P42 and P46 as shown at left.

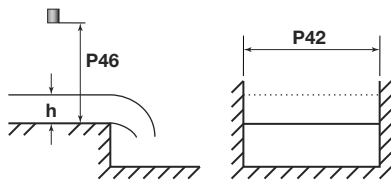

P40= 14 Bottom step weir

$$0.0005 < Q[\text{m}^3/\text{s}] < 1$$

$$0.3 < P42[\text{m}] < 15$$

$$0.1 < h[\text{m}] < 10$$

$$Q[\text{m}^3/\text{s}] = 5.073 * P42 * h^{1.5}$$

Enter the values for P42 and P46 as shown at left. P42 is the crest length.

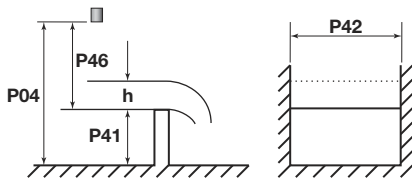

P40= 15 Rectangular weir without end contractions

$$0.001 < Q[\text{m}^3/\text{s}] < 5$$

$$0.15 < P41[\text{m}] < 0.8$$

$$0.15 < P42[\text{m}] < 3$$

$$0.015 < h[\text{m}] < 0.8$$

$$Q[\text{m}^3/\text{s}] = 1.7599 * [1 + (0.1534/P41)] * P42 * (h + 0.001)^{1.5}$$

The range (P04) value is larger than the reference distance (P46) as shown at left. P41 is the crest height, and P42 is the crest length. For proper flow conditions P41 should, at a minimum, be twice the value of the maximum Head (h). Enter values for P40, P41, P42, and P46.

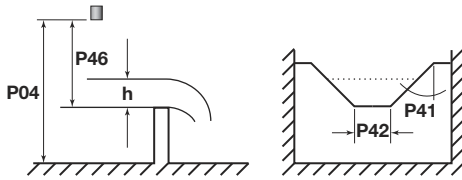

P40= 16 Trapezoidal weir

$$0.0032 < Q[\text{m}^3/\text{s}] < 82$$

$$20 < P41[^\circ] < 100$$

$$0.5 < P42[\text{m}] < 15$$

$$0.1 < h[\text{m}] < 2$$

$$Q[\text{m}^3/\text{s}] = 1.772 \cdot P42 \cdot h^{1.5} + 1.320 \cdot \text{tg}(P41/2) \cdot h^{2.47}$$

The range (P04) value is larger than the reference distance (P46) as shown at left. Enter values for P40, P41, P42, and P46.

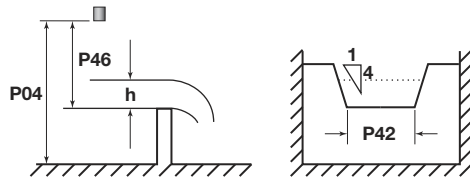

P40= 17 Cipoletti trapezoidal (4:1) weir

$$0.0018 < Q[\text{m}^3/\text{s}] < 50$$

$$0.3 < P42[\text{m}] < 10$$

$$0.1 < h[\text{m}] < 2$$

$$Q[\text{m}^3/\text{s}] = 1.866 \cdot P42 \cdot h^{1.5}$$

The range (P04) value is larger than the reference distance (P46) as shown at left. Enter values for P40, P42, and P46.

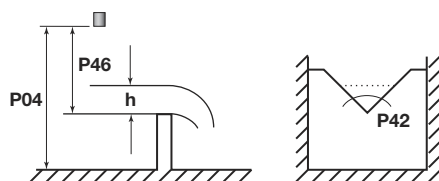

P40= 18 V-notch weir

$$0.0002 < Q[\text{m}^3/\text{s}] < 1$$

$$20 < P42[^\circ] < 100$$

$$0.05 < h[\text{m}] < 1$$

$$Q[\text{m}^3/\text{s}] = 1.320 \cdot \text{tg}(P42/2) \cdot h^{2.47}$$

The range (P04) value is larger than the reference distance (P46) as shown at left. P42 is the angle of the V-notch. Enter values for P40, P42, and P46.

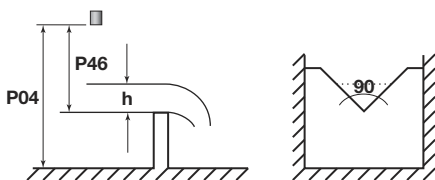

P40= 19 90° V-notch weir

$$0.0002 < Q[\text{m}^3/\text{s}] < 1$$

$$0.05 < h[\text{m}] < 1$$

$$Q[\text{m}^3/\text{s}] = 1.320 \cdot h^{2.47}$$

The range (P04) value is larger than the reference distance (P46) as shown at left. Enter values for P40 and P46.

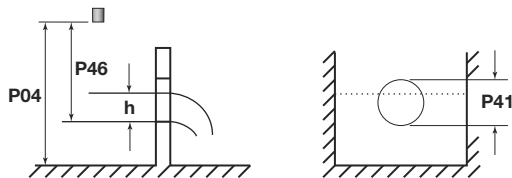

P40= 20 Circular weir

$$0.0003 < Q[\text{m}^3/\text{s}] < 25$$

$$0.02 < h[\text{m}] < 2$$

$$Q[\text{m}^3/\text{s}] = m \cdot b \cdot D^{2.5}$$

$$M = 0.555 + 0.418h/P41 + (P41/(0.11 \cdot h))$$

The range (P04) value is larger than the reference distance (P46) as shown at left. Enter values for P40, P41, and P46.

1.6.7 Linearization Table

Linearization Table (Flow Example)

Points	Head (ft.)	CFS
1	0.00	0.00
2	0.05	0.08
3	0.11	0.30
4	0.16	0.68
5	0.22	1.20
6	0.27	1.88
7	0.33	2.71
8	0.38	3.69
9	0.44	4.82
10	0.49	6.10
11	0.54	7.53
12	0.60	9.11
13	0.65	10.84
14	0.71	12.72
15	0.76	14.76
16	0.82	16.94
17	0.87	19.27
18	0.93	21.76
19	0.98	24.39
20	1.03	27.18
21	1.09	30.12
22	1.14	33.20
23	1.20	36.44
24	1.25	39.83
25	1.31	43.37
26	1.36	47.06
27	1.42	50.90
28	1.47	54.89
29	1.52	59.03
30	1.58	63.32
31	1.63	67.76
32	1.69	72.35

P47

Linearization

Factory default value for P47 is: 0

The Model 335 offers a 32-point linearization table for primary flow elements (open channel flow) or tank shapes (volume) that are not in the standard software. This table can also be used for establishing a level to level relationship, if the speed of sound (see P31) is not known for a vapor. To enable the linearization feature, change the value of P47 from 0 to 1.

P47	Linearization
0	Off (factory default)
1	On

P48

Linearization table

Factory default value for P48 is: 0

The linearization table is developed by pairing level values, with known volume or open channel flow values. Read below and next page prior to constructing the table.

Data is entered into the table in a 2×32 matrix, consisting of two columns:

Left column "L"	Right column "r"
Level measured by the 335	Volume, Flow or Level to be transmitted and displayed

The left column (indicated as "L" in the display) contains the level values measured by the Model 335 unit. The right column (indicated as "r" in the display) contains the volume, open channel flow, or level value corresponding to that height in the vessel or primary flow element. The figure below shows how to enter data into P48.

NOTE: P46 must also be set if the table is for open channel flow.

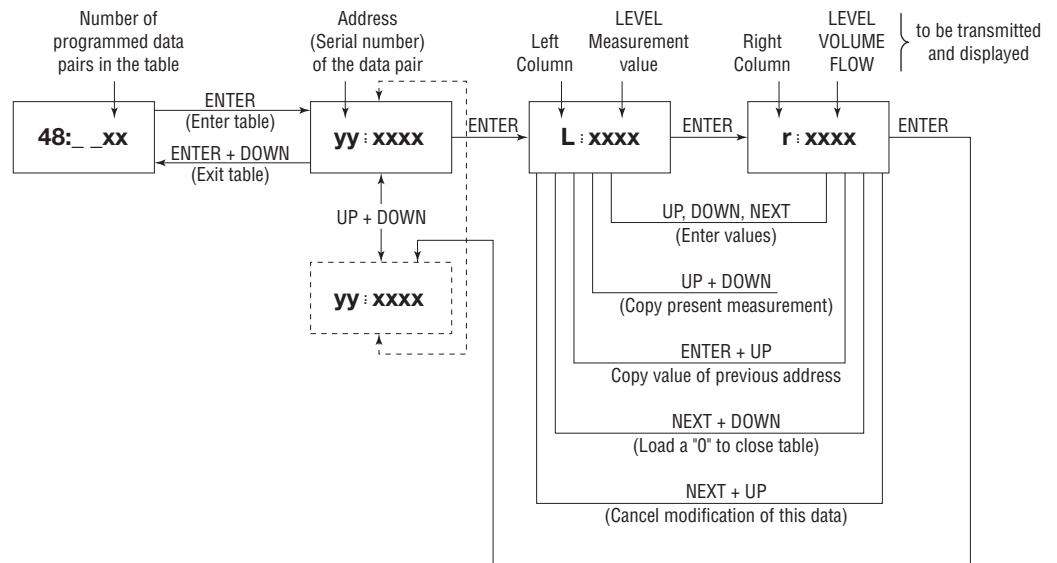

The linearization table must start off with a value being assigned to zero level in the vessel or primary flow element. This zero level is assigned to data pair point 01 as “L: 000.0” and “r: xxxx” filled in with the volume, open channel flow, or level value corresponding to the zero level value.

Data pair point	Left column “L”	Right column “r”
01:	L: 000.0	r: xxxx
02:	L: xxxx	r: xxxx
:	:	:
31:	L: xxxx	r: xxxx
32:	L: xxxx	r: xxxx

The table must be terminated either by completed all 32 data pair points, or if the table contains less than 32 points, the table must be closed by a zero level value. For example, a 16 point linearization table would have data pair point 16 as “L: 000.0.” After data pair point 01, the 335 will ignore any data in the linearization table after recognizing an “L” level value of 000.0. An error code will be displayed if the above format is not followed when entering values into the linearization table.

1.6.8 Information Parameters

Parameters P60 through P75 are used for viewing unit operating conditions, and transmitter diagnostics.

Parameter	Units	Description
P60	Hours	Total operating hours of unit
P61	Hours	Elapsed time since unit was last powered-up
P62	Hours	Operating hours of the relay
P63	Cycles	Number of relay cycles (energize/deenergize)

The display format for P60 – P63 varies depending on how long the unit has been operating. The table below shows the display format:

Operating hours	Display format
0 to 999.9 hours	xxx.x
1000 to 9999 hours	xxxx
Over 9999 hours	X.XX:E (meaning x.xx 10 ^e)

P64 – P66 indicate temperatures that the transducer has been exposed to:

Parameter	Units	Description
P64	° F or ° C	Current temperature of the transducer
P65	° F or ° C	Maximum temperature the transducer has been exposed to
P66	° F or ° C	Minimum temperature the transducer has been exposed to

Should the platinum temperature sensing element become damaged, "PtErr" will be displayed. Refer to *Section 1.8, Diagnostic Error Codes*, for a listing of all the error codes.

P70 Echo Map

P70 displays the number of echoes being detected by the transmitter. Entering P70 will save the current echo map, and the distance and amplitude of each echo can be individually displayed.

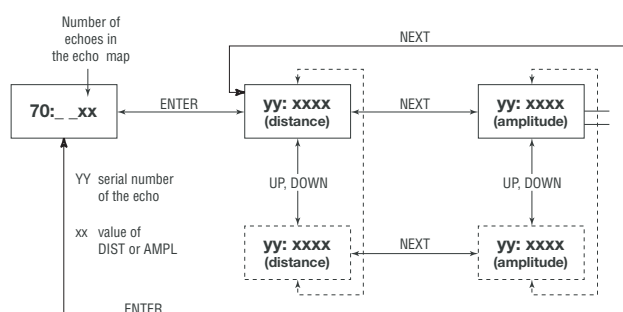

The Measuring Window can be manually moved to one of the echoes displayed in the echo map:

1. Select an echo in the echo map (display indicates the distance of the selected echo)
2. Press the UP + DOWN keys simultaneously (display will indicate "Set 33")
3. The selected echo is loaded into the P33 parameter (see P33)

Parameters P71 through P73 display data concerning the Measuring Window that is described in P33. These are readout only parameters.

Parameter	Description
P71	Distance of the Measuring Window
P72	Amplitude of the echo in the Measuring Window
P73	Position of the echo (in milliseconds)

P74 Signal to Noise Ratio

P74 gives an indication of the ratio between the return ultrasonic signal received by the transducer, and the amount of electrical and acoustic noise that is also being received.

S/N Ratio	Measurement conditions
Over 70	Excellent
Between 70 and 30	Good
Under 30	Unreliable

P75 Actual Deadband Distance

P05 is used to set the deadband distance. P75 is a readout only parameter that shows the actual deadband value that the unit uses for diagnostic purposes.

1.6.9 Open Channel Flow Head and Totalizers

P76 Head of Flow

Head is the “h” value used in the calculation formula selected in P40. It is the distance from the zero flow elevation in the flume or weir, to the surface of the water. P76 displays the current head value based on the level in the flume or weir, and the values that were put in for P40 – P46. If the unit has not been set up for open channel flow use, the value of P76 will be 0.00.

P77 Resettable totalizer (T1)

P77 displays the value of the resettable totalizer used for open channel flow. To reset T1:

1. While in P77, press NEXT + DOWN simultaneously
2. The display will indicate “t1 CLr”
3. Press ENTER to clear (reset) the totalizer

P78 Non-resettable totalizer (T2)

P78 displays the value of the non-resettable totalizer used for open channel flow.

1.6.10 Output Test Parameters

P80 Current (mA) output test

P80 can be used to test the mA current output from the transmitter, to make sure it agrees with an external meter. When entering P80, the actual mA current output will be displayed. Press to set any value between 3.8 and 20.5 mA. Check the mA current output by using either a multi-meter or an external display. Return to the parameter address (P80) by pressing ENTER .

P81 Relay output test

The state of the relay can be seen in P81 according to the table below and presence of a 0 or 1 in the display. The relay can be tested by pressing UP and DOWN to switch P81 from a value of 1 to 0 and back. As the relay energizes and de-energizes the RELAY LED will turn on and off, and the resistance can be checked by a multimeter.

P81	Relay state
0	De-energized
1	Energized

1.6.11 Simulation Mode

The Simulation Mode enables the user to test the settings of the outputs. Once configured, the Model 335 is able to simulate a static or continuous change of level.

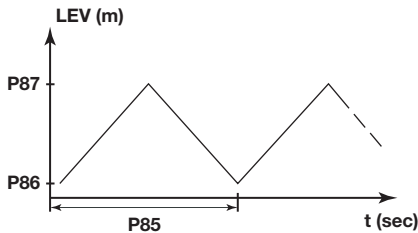

P84 Simulation type

Factory default value for P84 is: 0

P84 is used to select the type of simulation that is desired as described below:

P84	Simulation type
0	No simulation (factory default)
1	Level changes continuously up and down between the level values set in P86 and P87 with a cycle time as set in P85
2	Static level simulation - the level will be the value set in P86

Enter values in P85 – P87 as described below to complete the simulation mode configuration. Note that the simulation levels must be within the programmed values for measuring range (P04) and deadband (P05).

Parameter	Default Value	Description
P85	10	Cycle time (in seconds) for simulation
P86	0.00	Simulated low level value
P87	0.00	Simulated high level value

To start the simulation mode, return to the measurement mode. While in simulation mode the DIST, LEV or VOL symbol will be blinking. To quit the simulation mode, reset P84 back to zero.

1.6.12 Additional Software Parameters

P97 Software Code

P97 stores the software revision number.

P99 Password Protection

P99 allows the entry of a password to protect all of the software configuration data. This provides protection against accidental (or intentional) re-programming of any parameters.

The password can be any numeric value other than **0000**. After setting a password, the password protection will automatically be activated when the unit is returned to the Measurement Mode. If password protection is activated, the software parameters can only be viewed; this is indicated by a flashing colon ":" between the parameter address and the parameter value.

In order to program a unit that has password protection, first enter the password in **P99**. The password protection is re-activated each time the unit is returned to the Measurement Mode. To delete the password protection feature, enter the password in **P99**. After confirming it with **ENTER**, re-enter parameter **P99** as **0000** as shown below:

[enter password] → **P99** → **:** → [0000] → **ENTER** password protection is turned off.

1.7 Diagnostic Error Codes

There are a total of 13 different error codes that the Model 335 will produce depending on what type of malfunction occurs. Should this table not resolve the issue with the Model 335, please contact the factory for further assistance. Any returns to the factory must be accompanied by an RMA (return material authorization) number, which can be obtained by our Customer Satisfaction Department.

Code	Error description	Causes and actions to be done
1	Memory error	Contact local representative or the factory
“No Echo” or 2	Echo loss	No echo received (no reflection)
3	Hardware error	Contact local representative or the factory
4	Overflow	Check settings
5	Code referring to transducer error. Can be due to improper installation/mounting, or level in the deadband (see P05)	Check for correct transducer mounting & operation. Verify that that the liquid level is not inside the deadband set in P05.
6	Measurement is at the reliability threshold (only for solids level applications)	Re-aim the transducer, or try to find a better mounting location
7	No signal received within the measuring range specified in P04 and P05.	Review programming, also look for any installation mistakes
12	Linearization table error: L(01) and L(02) are both zero (no valid data pairs)	See section 1.67 on Linearization Table
13	Linearization table error: there are two same left column L(xx) data in the table	See section 1.67 on Linearization Table
14	Linearization table error: the right column r(xx) values are not in increasing order	See section 1.6.7 on Linearization Table
15	Linearization table error: measured level is higher than the last volume or flow data-pair	See section 1.6.7 on Linearization Table
16	The checksum of the program in the EEPROM is wrong	Contact local representative or the factory
“PtErr”	Break in the temperature sensor circuit	Contact local representative or the factory

2.0 Reference Information

2.1 Description

The Model 335 ultrasonic transmitter performs level, volume, and open channel flow measurement of liquids. Measurement based on non-contact ultrasonic technology is especially suited for applications where no physical contact can be made to the surface of the liquid material to be measured. This is especially important in applications containing corrosive materials, suspended solids or coating media.

2.2 Theory of Operation

Non-contact ultrasonic measurement is made by emitting an ultrasonic pulse from the transducer and measuring the time required for the echo to reflect from the liquid surface and return to the transducer. The powerful electronics measure the time of the round trip pulse and, by knowing the speed of sound, calculates the distance. Since speed of sound is temperature dependent, the transducer also measures the temperature in the vessel to provide compensation for changing temperature.

By inputting the type and geometry of the vessel, the intelligent electronics can calculate the liquid volume in the vessel. In a similar operation, the Model 335 can perform open channel flow measurement by converting the level reading into units of volume per time. Common tank shapes, flumes, and weirs are stored in the 335 software. A 32-point linearization table is also available for unusual tanks or primary flow elements.

2.3 Performance

Model 335 Transmitters are high performance units that feature a powerful 50 kHz transducer, highly collimated beam angles, and advanced digital signal processing. These features allow the 335 to accurately track the liquid level in difficult applications involving agitation and light foam. The extremely narrow 7° beam angle, shown at left, allows the 335 to be used in applications where other units with wider beam angles fail due to false reflections.

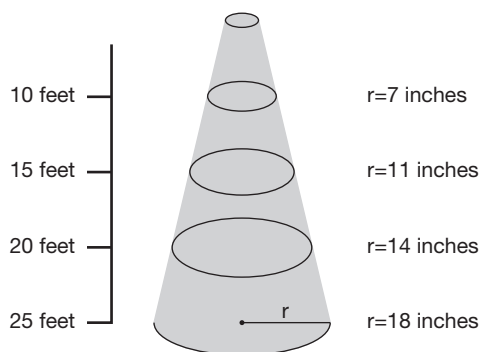

Beam Radius vs. Distance

2.4 Measurement Range Calculations

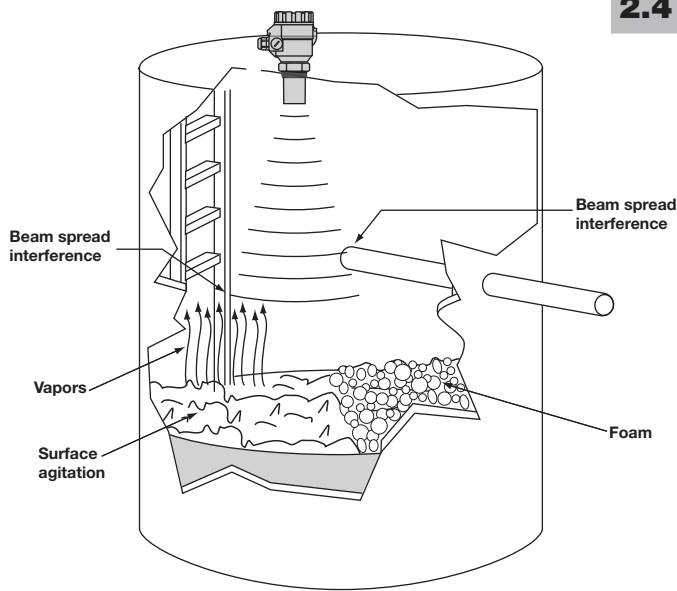

Ultrasonic non-contact transmitters are typically rated for a maximum range in ideal conditions. Experience has shown that maximum range must be reduced for certain factors. Although the maximum range rating is somewhat conservative, each application must be evaluated for specific conditions in the tank.

Several application parameters that affect ultrasonic performance are shown in the tank at the left. Each of these parameters is assigned a Performance Multiplier in the chart below. Multiply the maximum potential range (26 feet or 8 meters) of the Model 335 by each of the applicable Performance Multipliers to calculate the maximum allowable range for the application.

Operating parameter	Condition	Performance multiplier
SURFACE AGITATION: Surface agitation or waves can degrade the performance. Moderate agitation results in only slight degradation of performance. The worst case is when the surface is a good reflector, but in the wrong direction.	Smooth, glass-like surface	1.0
	Slight agitation, choppiness	0.9
	Heavy agitation	0.8
	Slight vortex	0.7
VAPORS AND STEAM: Vapors can cause problems when the liquid process temperature is well above the temperature of the airspace. The greater the difference, the more expected vapor problems. The problems result from condensation or layering in the sound path, both of which attenuate the sound signal, and degrade performance. If a vent is used, be sure that it is well away from the transducer.	No condensation	1.0
	Little condensation	0.9
	Much condensation / foggy appearance	0.8
BEAM SPREAD INTERFERENCE: It is recommended that no obstructions, such as ladder rungs, fill pipes, support struts, etc., be allowed within the 7° ultrasonic beam. If an obstruction is unavoidable, make it as far away as possible from the transducer. Interference from agitator blades is only an intermittent interference that usually has little effect on performance. A special software algorithm can also help suppress false echoes from agitator blades that are within the beam angle.	No interference within 3.5° half beam angle	1.0
	Agitator at speed less than 60 RPM	1.0
	Interference outside 2°, far from transducer (in bottom third of range)	0.8
	Interference outside 2°, near to transducer (in top third of range)	0.5
	Agitator at speed greater than 60 RPM	C/F
FOAM: Foam can attenuate the ultrasound and render the system inoperative. If possible, moving the transducer to an area in the tank where there is less foam will improve the performance. Thick, heavy-density foams can sometimes produce a reflection from the top of the foam.	No foam	1.0
	Light froth, less than 0.25" thick	0.8
	Light foam, less than 0.5" thick	0.5
	Light foam, more than 1" thick	0.1

EXAMPLE: A heavily agitated 15' tank with no condensation, no interference, and a light froth on the surface.

Maximum allowable range: $26' \times 0.8 \times 1.0 \times 1.0 \times 0.8 = 16.6$ feet
 Since the maximum allowable range is 16.6 feet, the 335 is suitable for this 15 foot tank.

NOTE: The multipliers shown above are general guidelines.
 For further assistance consult the factory.

2.5 Velocity of Sound in Gases other than Air

The velocity of sound through air is 1,128 ft/sec (343.8 m/sec) as indicated in P31. This velocity is used for all measurements made by the Model 335 transmitter. The table below contains the velocity of sound for various gases measured @ +68° F (+20° C). These velocities can be used in P31 if the gas exists as a homogeneous layer in the tank.

Gases	Chemical Formula	Velocity (ft/sec)	Velocity (m/s)
Acetaldehyde	C ₂ H ₄ O	829.4	252.8
Acetylene	C ₂ H ₂	1118.2	340.8
Ammonia	NH ₃	1410.5	429.9
Argon	Ar	1047.0	319.1
Benzene	C ₆ H ₆	601.7	183.4
Carbon dioxide	CO ₂	880.3	268.3
Carbon monoxide	CO	1145.7	349.2
Carbon tetrachloride	CCl ₄	492.8	150.2
Chlorine	Cl ₂	697.9	212.7
Dimethyl ether	CH ₃ OCH ₃	700.2	213.4
Ethane	C ₂ H ₆	1074.2	327.4
Ethanol	C ₂ H ₅ OH	877.0	267.3
Ethylene	C ₂ H ₄	1080.8	329.4
Helium	He	3263.0	994.5
Hydrogen sulphide	H ₂ S	1053.5	321.1
Methane	CH ₄	1461.7	445.5
Methanol	CH ₃ OH	1138.5	347
Neon	Ne	1475.1	449.6
Nitrogen	N ₂	1145.4	349.1
Nitrous oxide	N ₂ O	1135.2	346
Oxygen	O ₂	1078.1	328.6
Propane	C ₃ H ₈	808.8	246.5
Sulfur hexafluoride	SF ₆	452.1	137.8

2.6 Specifications

2.6.1 Performance

<i>Accuracy</i>	(±0.2% of the measured distance, plus 0.05% of the range)
<i>Resolution</i>	1 mm for up to 6.5 feet (2 m) 2 mm for 6.5 to 16.4 feet (5 m) 5 mm for 16.4 to 26 feet (8m)

2.6.2 Transmitter

<i>Supply voltage</i>	85 to 255 VAC (2 VA) (Input power code A) (Input power code D) 20 to 28 VDC (3W)
<i>Output signal</i>	4-20 mA isolated, 600 ohm load
<i>Fault detection</i>	Configurable 3 amp SPDT relay, LED, and 3.6 or 22 mA (NAMUR NE 43)
<i>Relays</i>	One, 3 Amp SPDT, 250 VAC, and one 1-amp SPDT, 30 VDC
<i>Failsafe</i>	Software selectable
<i>User Interface: Keypad</i>	4-button menu-driven data entry
<i>Display</i>	Removable 6 digit LCD module with dual function bar graph
<i>LED status indication</i>	Echo strength
<i>Ambient temperature</i>	-22° to +160° F (-30° to 70° C)
<i>Enclosure</i>	Cast aluminum (IP 67)
<i>Electrical connections</i>	Two – ½" NPT and Two – M20 × 1.5

2.6.3 Transducer

<i>Maximum range</i>	26 feet (8 meters)
<i>Deadband</i>	14 inches (350 mm)
<i>Frequency</i>	50 kHz
<i>Process connection</i>	2 inch NPT (flanges optionally available)
<i>Process temperature</i>	-22° to +195° F (-30° to +90° C)
<i>Process pressure</i>	Atmospheric to 44 psi (3 bar)
<i>Ultrasonic beam angle</i>	7 degrees conical
<i>Temperature compensation</i>	Automatic over the operating temperature range of the transducer
<i>Transducer</i>	Polypropylene (IP 68)



These units have been tested to EN 50081-2 and EN 50082-2 and are in compliance with the EMC Directive 89/336/EEC.

2.6.4 Physical

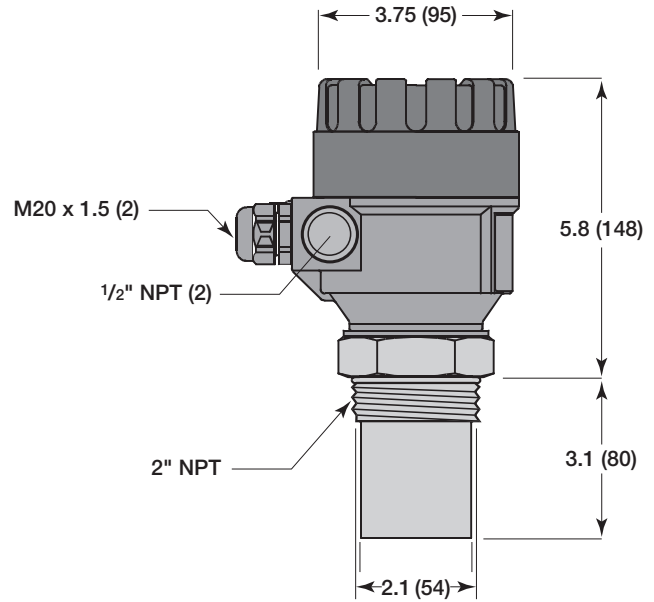

2.7 Model Number

BASIC MODEL NUMBER

335	Integrally mounted transmitter with 50 kHz transducer, aluminum housing, polypropylene transducer
-----	---

ELECTRONICS HOUSING

A	Cast aluminum dual compartment
---	--------------------------------

INPUT POWER

A	85 to 255 VAC
D	20 to 28 VDC

SIGNAL OUTPUT

1	4-20 mA & SPDT relay
---	----------------------

ACCESSORIES

0	No digital display/programming module
A	Digital display/ programming module included

AGENCY APPROVALS

G	General purpose (NEMA 6)
---	--------------------------

MOUNTING

5	2" NPT
---	--------

TRANSDUCER

P	Polypropylene
---	---------------

3	3	5	A		1		G	5	P
---	---	---	---	--	---	--	---	---	---

2.8 Configuration Parameter Worksheet

Par.	Page	Description	Value
P00	13	Application and Engineering Units	
P01	14	Bar Graph and Measurement Mode	
P02	15	Calculation Units	
P03	16	Displayed Values (rounding)	
P04	17	Range	
P05	18	Deadband	
P06	18	Far-end Blocking	
P07		not used	
P08		not used	
P09		not used	
P10	19	4 mA Current Output Value	
P11	19	20 mA Current Output Value	
P12	19	Failsafe Indication	
P13	20	Relay Operation	
P14	20	Relay Setpoint Value	
P15	20	Relay Setpoint Value	
P16	20	Relay Pulse Rate (remote totalizer)	
P17		not used	
P18		not used	
P19		not used	
P20	21	Damping	
P21		not used	
P22	21	Dome Top Tank Compensation	
P23		not used with the 335	
P24	22	Target Tracking Speed	
P25	22	Echo Selection in Measurement Window	
P26	23	Vessel Fill Rate	
P27	23	Vessel Drain Rate	
P28	23	Echo Loss Error Reporting	
P29	24	False Target # 1	
P30	24	False Target # 2	
P31	24	Speed of Sound Through Gas	
P32	24	Specific Gravity	
P33	25	Manual Echo Selection	
P34		not used	
P35		not used	
P36		not used	
P37		not used	
P38		not used	
P39		not used	
P40	26	Shape of Tank, Flume, or Weir	
P41	26	Dimensions of Tank, Flume or Weir	
P42	26	Dimensions of Tank, Flume or Weir	
P43	26	Dimensions of Tank, Flume or Weir	
P44	26	Dimensions of Tank, Flume or Weir	
P45	26	Dimensions of Tank, Flume or Weir	
P46	28	Reference Distance	
P47	31	Linearization	
P48	31	Linearization Table	
P49		not used	
P50		not used	
P51		not used	

Par.	Page	Description	Value
P52		not used	
P53		not used	
P54		not used	
P55		not used	
P56		not used	
P57		not used	
P58		not used	
P59		not used	
P60	32	Total Unit Operating Hours	
P61	32	Elapsed Time Since Powered-up	
P62	32	Operating Hours of the Relay	
P63	32	Number of Relay Cycles	
P64	33	Current Temperature of the Transducer	
P65	33	Maximum Temperature of the Transducer	
P66	33	Minimum Temperature of the Transducer	
P67		not used	
P68		not used	
P69		not used	
P70	33	Echo Map	
P71	33	Distance of the Measuring Window	
P72	33	Amplitude of Echo in Measuring Window	
P73	33	Position of Echo	
P74	33	Signal to Noise Ratio	
P75	34	Actual Deadband Distance	
P76	34	Head of Flow	
P77	34	Resettable Totalizer (T1)	
P78	34	Non-resettable Totalizer (T2)	
P79		not used	
P80	34	Current (mA) Output Test	
P81	35	Relay Output Test	
P82		not used	
P83		not used	
P84	35	Simulation Type	
P85	35	Cycle Time for Simulation	
P86	35	Simulated Low Level Value	
P87	35	Simulated High Level Value	
P88		not used	
P89		not used	
P90		not used	
P91		not used	
P92		not used	
P93		not used	
P94		not used	
P95		not used	
P96		not used	
P97	36	Software Code	
P98		not used	
P99	36	Password Protection	

Service Policy

Owners of Magnetrol may request the return of a or any part of a control for complete rebuilding or replacement. They will be rebuilt or replaced promptly. Controls returned under our service policy must be returned by prepaid transportation. Magnetrol will repair or replace the control at no cost to the purchaser (or owner) other than transportation if:

1. Returned within the warranty period; and
2. The factory inspection finds the cause of the claim to be covered under the warranty.

If the trouble is the result of conditions beyond our control; or, is NOT covered by the warranty, there will be charges for labor and the parts required to rebuild or replace the equipment.

In some cases it may be expedient to ship replacement parts; or, in extreme cases a complete new control, to replace the original equipment before it is returned. If this is desired, notify the factory of both the model and serial numbers of the control to be replaced. In such cases, credit for the materials returned will be determined on the basis of the applicability of our warranty.

No claims for misapplication, labor, direct or consequential damage will be allowed.

Return Material Procedure

So that we may efficiently process any materials that are returned, it is essential that a "Return Material Authorization" (RMA) number be obtained from the factory, prior to the material's return. This is available through a Magnetrol local representative or by contacting the factory. Please supply the following information:

1. Company Name
2. Description of Material
3. Serial Number
4. Reason for Return
5. Application

Any unit that was used in a process must be properly cleaned in accordance with OSHA standards, before it is returned to the factory.

A Material Safety Data Sheet (MSDS) must accompany material that was used in any media.

All shipments returned to the factory must be by prepaid transportation.

All replacements will be shipped F.O.B. factory.



5300 Belmont Road • Downers Grove, Illinois 60515-4499 • 630-969-4000 • Fax 630-969-9489 • www.magnetrol.com
145 Jardin Drive, Units 1 & 2 • Concord, Ontario Canada L4K 1X7 • 905-738-9600 • Fax 905-738-1306
Heikensstraat 6 • B 9240 Zele, Belgium • 052 45.11.11 • Fax 052 45.09.93
Regent Business Ctr., Jubilee Rd. • Burgess Hill, Sussex RH15 9TL U.K. • 01444-871313 • Fax 01444-871317

Copyright © 2011 Magnetrol International, Incorporated. All rights reserved. Printed in the USA.

BULLETIN: 51-637.1
EFFECTIVE: May 2011
SUPERSEDES: March 2011