

In-Line Detonation Flame Arrester

for stable detonations and deflagrations in a straight through design with shock tube, bidirectional

PROTEGO® DA-SB

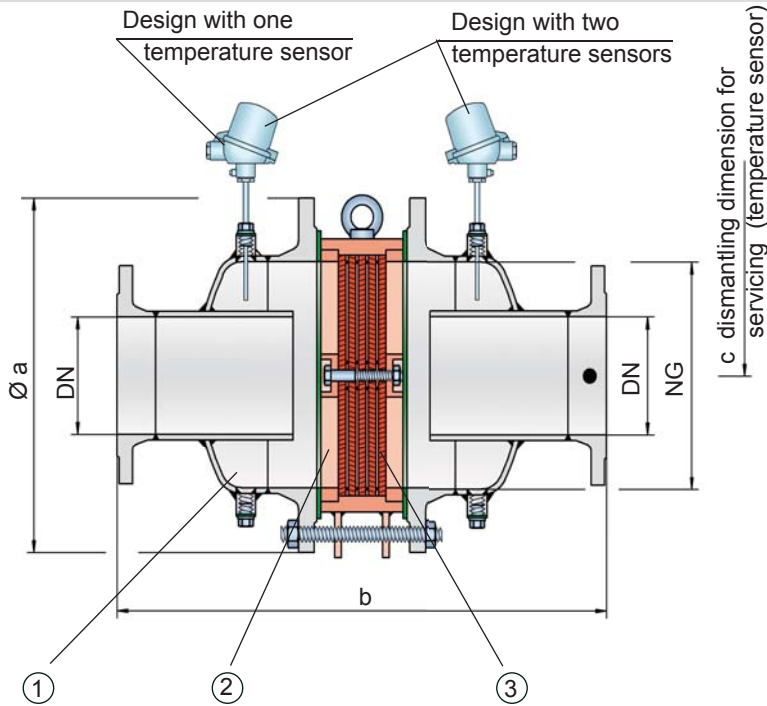

● Connection to the protected side (only for type DA-SB-T-...)

Function and Description

The in-line detonation flame arresters type PROTEGO® DA-SB are the newest generation of flame arresters. On the basis of fluid dynamic, explosion dynamics calculation and decades of experience from field tests, a product line was developed that offers minimum pressure loss and maximum safety. The flame arrester uses the *Shock Wave Guide Tube Effect (SWGTE)* to separate the flame front and shock wave. The result is an in-line detonation arrester without a classic shock absorber; in addition the use of FLAMEFILTER® discs is minimized.

The devices are symmetrical and offer bidirectional flame arresting for deflagrations and stable detonations. The arrester essentially consists of two housing parts with an integrated shock tube (1) and the PROTEGO® flame arrester unit (2) in the center. The PROTEGO® flame arrester unit is modular and consists of several FLAMEFILTER® discs (3) and spacers firmly held in a FLAMEFILTER® cage. The number of FLAMEFILTER® discs and their gap size depends on the arrester's conditions of use.

By indicating the operating parameters such as temperature, pressure and explosion group, and the composition of the fluid, the optimum detonation arrester can be selected from a series of approved devices. The PROTEGO® DA-SB flame arresters are available for all explosion groups.

The standard design can be used up to an operating temperature of +60°C / 140°F and an absolute operating pressure up to 1.1 bar / 15.9 psi. Numerous devices with special approval can be obtained for higher pressures (see table 3) and higher temperatures.

Type-approved in accordance with the current ATEX Directive and EN ISO 16852 as well as other international standards.

Special Features and Advantages

- optimized performance from the patented *Shock Wave Guide Tube Effect (SWGTE)*
- less number of FLAMEFILTER® discs from the use of the patented shock tube (*SWGTE*)
- modular flame arrester unit enables each individual FLAMEFILTER® discs to be replaced and cleaned
- different series allow increase of FLAMEFILTER® size for given flange connection resulting in lower pressure drop across the device
- service-friendly design
- expanded application range for higher operating temperatures and pressures
- bidirectional operation as well as any direction of flow and installation position
- installation of temperature sensors are possible
- minimum pressure loss and associated low operating and life-cycle cost
- cost efficient spare parts

Design Types and Specifications

There are four different designs available:

Basic in-line detonation flame arrester	DA-SB - <input type="checkbox"/> - <input type="checkbox"/>
In-line detonation flame arrester with integrated temperature sensor* as additional protection against short time burning from one side	DA-SB - <input type="checkbox"/> - <input type="checkbox"/>
In-line detonation flame arrester with two integrated temperature sensors* for additional protection against short time burning from both sides	DA-SB - <input type="checkbox"/> - <input type="checkbox"/>
In-line detonation flame arrester with heating jacket	DA-SB - <input type="checkbox"/> - <input type="checkbox"/>
Additional special flame arresters upon request	

*Resistance thermometer for device group II, category (1) 2 (GII cat. (1) 2)

Table 1: Dimensions

Dimensions in mm / inches

To select nominal width/nominal size (NG/DN) - combination, please use the flow capacity charts on the following pages		Additional nominal width/nominal size (NG/DN) - combinations for improved flow capacity upon request										
standard (special sizes up to NG 2000/80", DN 1000/40" available)												
NG	150 6"	150 6"	200 8"	300 12"	400 16"	500 20"	600 24"	700 28"	800 32"	1000 40"	1200 48"	1600 64"
DN	≤ 50 2"	65, 80 2 1/2", 3"	≤ 100 4"	≤ 150 6"	≤ 200 8"	≤ 250 10"	≤ 300 12"	≤ 350 14"	≤ 400 16"	≤ 500 20"	≤ 600 24"	800 32"
a	285 / 11.22	285 / 11.22	340 / 13.39	445 / 17.52	565 / 22.24	670 / 26.38	780 / 30.71	895 / 35.24	1015 / 39.96	1230 / 48.43	1455 / 57.28	1915 / 75.39
IIA-P1,1	388 / 15.28	388 / 15.28	476 / 18.74	626 / 24.65	700 / 27.56	800 / 31.50*	1000 / 39.37*	1200 / 47.24	1400 / 55.12	1600 / 62.99	1800 / 70.87	2200/ 86.61**
IIA-P1,4-X3	400 / 15.75	400 / 15.75	488 / 19.21	626 / 24.65	724 / 28.50	800 / 31.50	1000 / 39.37	1200 / 47.24	1400 / 55.12			
b												
IIB3-P1,1	400 / 15.75	412 / 16.22	500 / 19.69	650 / 25.59	724 / 28.50	824 / 32.44	1000 / 39.37	1200 / 47.24	1400 / 55.12	1600 / 62.99	1800 / 70.87	
IIB3-P1,4-X3	412 / 16.22	412 / 16.22	512 / 20.16	650 / 25.59	724 / 28.50	824 / 32.44	1000 / 39.37	1200 / 47.24	1400 / 55.12			
IIC-P1,1	400 / 15.75	400 / 15.75	500 / 19.69	638 / 25.12	700 / 27.56	788 / 31.02	1000 / 39.37***	1200 / 47.24***	1400 / 55.12***			
c												
	500 / 19.69	500 / 19.69	520 / 20.47	570 / 22.44	620 / 24.41	670 / 26.38	720 / 28.35	770 / 30.31	820 / 32.28	950 / 37.40	1050 / 41.34	1250 / 49.21

* dimension b only for P1.4 / 20.3

** dimension b only for P1.2 / 17.4

*** EN 12874

Table 2: Selection of the explosion group

MESG	Expl. Gr. (IEC/CEN)	Gas Group (NEC)	Special approvals upon request
> 0,90 mm	IIA	D	
≥ 0,65 mm	IIB3	C	
< 0,50 mm	IIC	B	

Table 3: Selection of max. operating pressure

NG		150 6"	150 6"	200 8"	300 12"	400 16"	500 20"	600 24"	700 28"	800 32"	1000 40"	1200 48"	1600 64"
DN		≤ 50 2"	65, 80 2 1/2", 3"	≤ 100 4"	≤ 150 6"	≤ 200 8"	≤ 250 10"	≤ 300 12"	≤ 350 14"	≤ 400 16"	≤ 500 20"	≤ 600 24"	800 32"
Expl. Gr.	IIA	P _{max}	2.1 / 30.5	2.1 / 30.5	2.1 / 30.5	2.1 / 30.5	2.1 / 30.5	1.4 / 20.3	1.4 / 20.3	1.4 / 20.3	1.1 / 15.9	1.1 / 15.9	1.2 / 17.4
	IIB3	P _{max}	1.4 / 20.3	1.4 / 20.3	1.4 / 20.3	1.8 / 26.1	1.8 / 26.1	1.8 / 26.1	1.8 / 26.1	1.4 / 20.3	1.4 / 20.3	1.1 / 15.9	1.1 / 15.9
	IIC	P _{max}	2.2 / 31.9	2.2 / 31.9	1.1 / 15.9	1.1 / 15.9	1.1 / 15.9	1.1 / 15.9	1.1 / * 15.9	1.1 / * 15.9	1.1 / * 15.9		

 P_{max} = maximum allowable operating pressure in bar / psi absolut, higher operating pressure upon request

 in-between size up to P_{max} upon request

* capacity charts upon request



for safety and environment

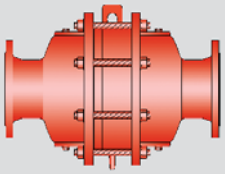

In-Line Detonation Flame Arrester

for stable detonations and deflagrations in a straight through design with shock tube, bidirectional

PROTEGO® DA-SB

Table 4: Specification of max. operating temperature

≤ 60°C / 140°F	≤ 200°C / 392°F	T _{maximum allowable operating temperature in °C}	higher operating temperatures upon request
-	X3	Designation	

Table 5: Material selection for housing

Design	A	B	C	The housing is also available in Steel with ECTFE coating.
Housing	Steel	Stainless Steel	Hastelloy	
Heating jacket (DA-SB-(T)-H-...)	Steel	Stainless Steel	Stainless Steel	
Gasket	PTFE	PTFE	PTFE	
Flame arrester unit	A, B	B, C, D	D	

Special materials upon request

Table 6: Material combinations of the flame arrester unit

Design	A	B	C	D	*the FLAMEFILTER® are also available in the materials Tantalum, Inconel, Copper, etc. when the listed housing and cage materials are used.
FLAMEFILTER® cage	Steel	Stainless Steel	Stainless Steel	Hastelloy	
FLAMEFILTER® *	Stainless Steel	Stainless Steel	Hastelloy	Hastelloy	
Spacer	Stainless Steel	Stainless Steel	Hastelloy	Hastelloy	

Special materials upon request

Table 7: Flange connection type

EN 1092-1; Form B1	other types upon request
ASME B16.5; 150 lbs RFSF	

* P1.4
** P1.2

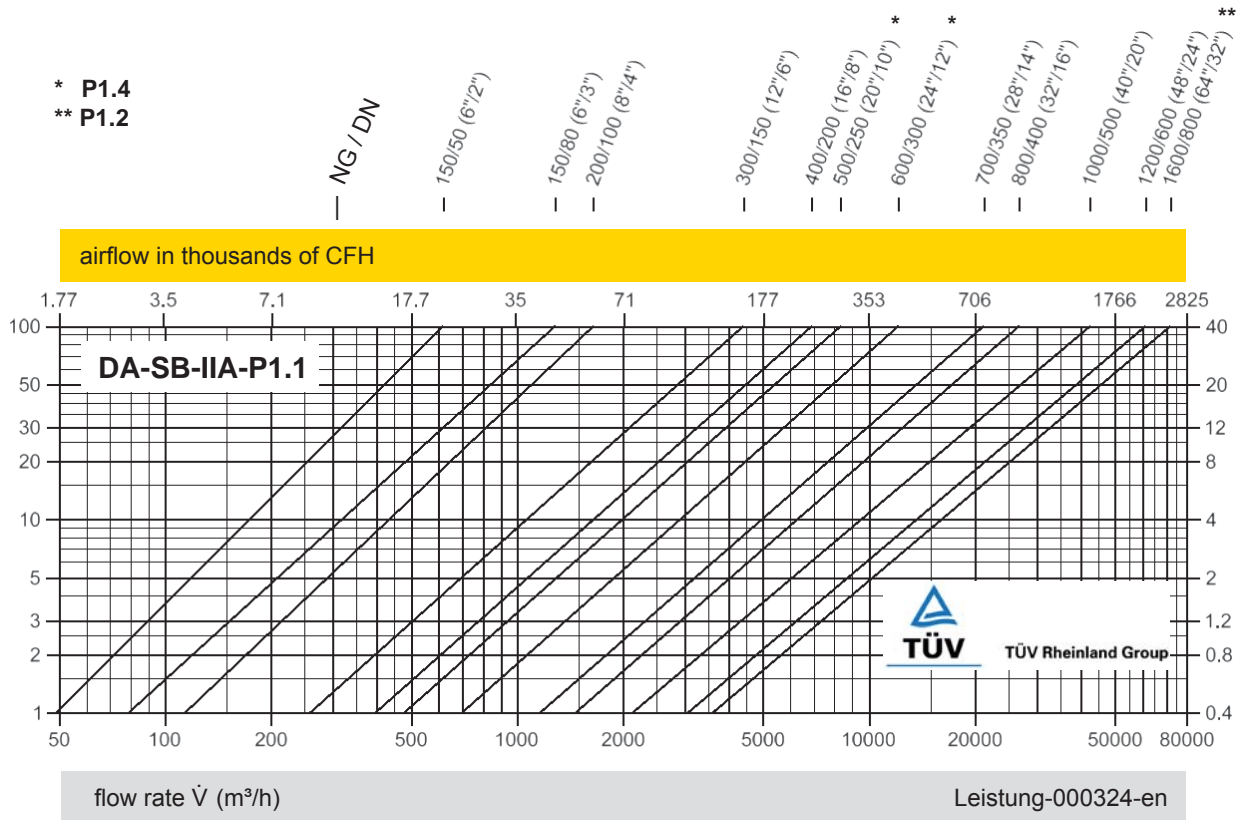

X3 maximum allowable operating temperature 200 °C

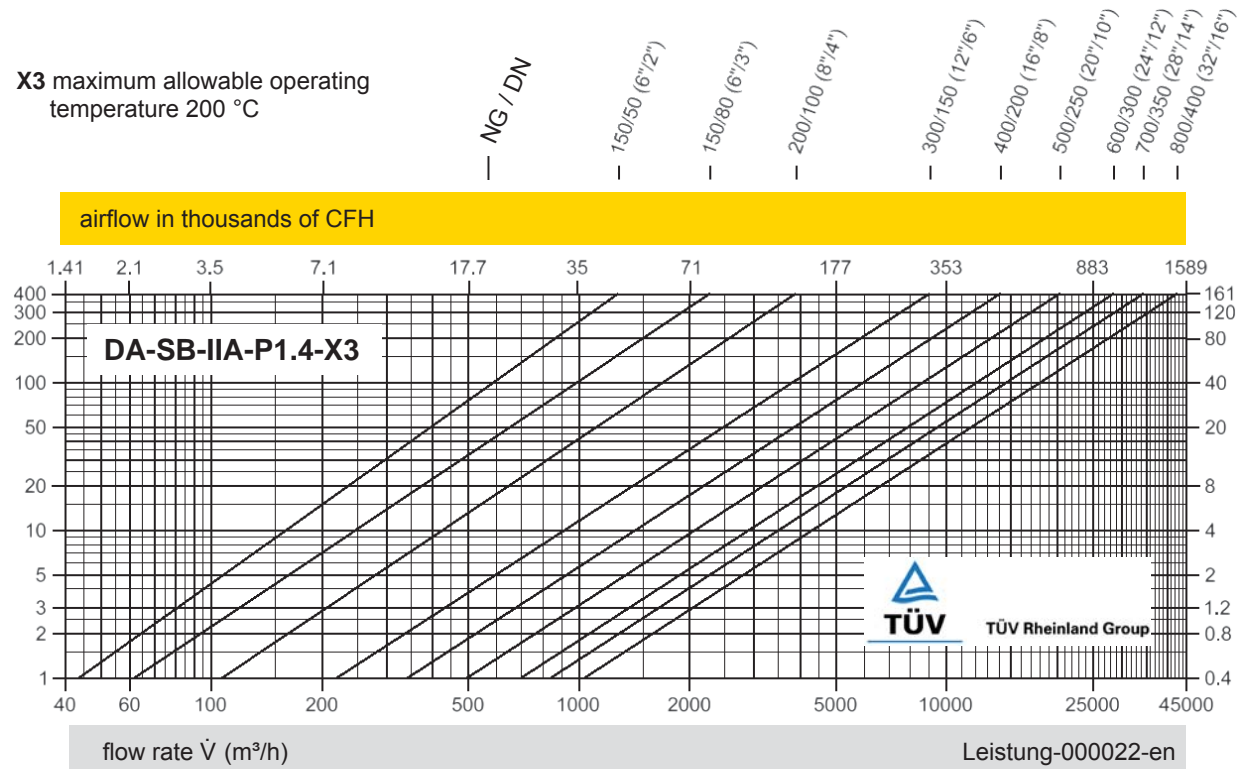

The flow capacity charts have been determined with a calibrated and TÜV certified flow capacity test rig. Volume flow \dot{V} in (m³/h) and CFH refer to the standard reference conditions of air ISO 6358 (20°C, 1bar). Conversion to other densities and temperatures refer to Vol. 1: "Technical Fundamentals".



for safety and environment

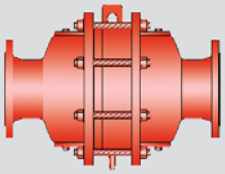

In-Line Detonation Flame Arrester

Flow Capacity Charts

PROTEGO® DA-SB

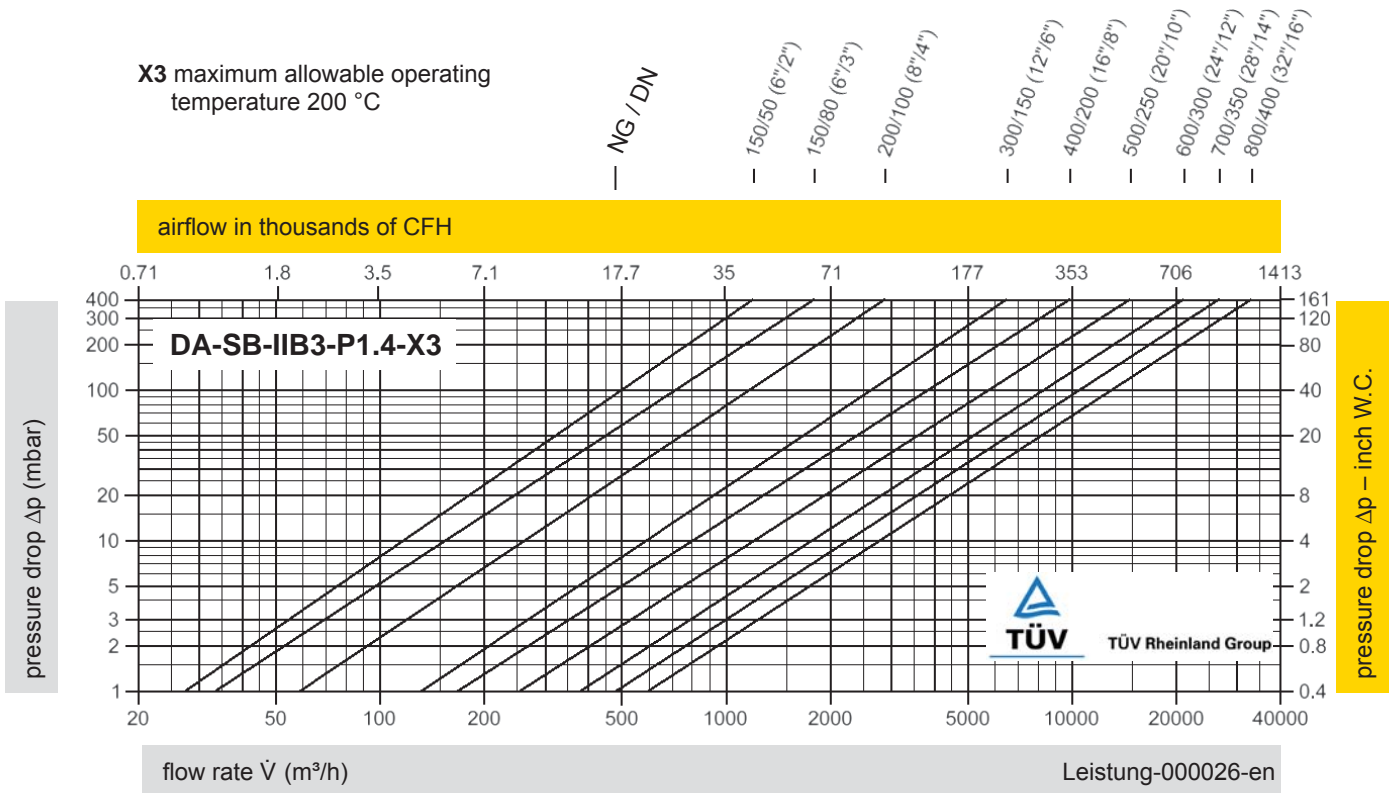
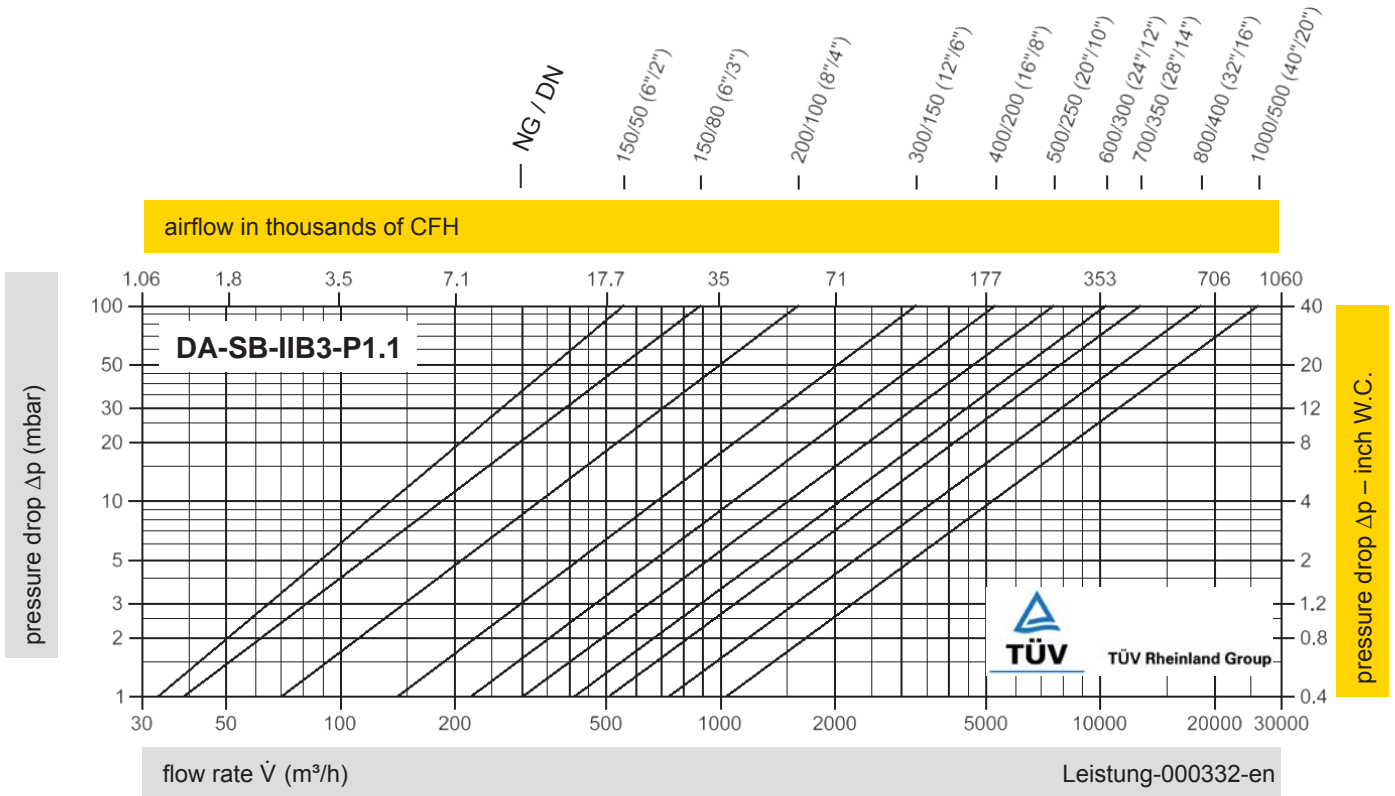

The flow capacity charts have been determined with a calibrated and TÜV certified flow capacity test rig.

Volume flow \dot{V} in (m³/h) and CFH refer to the standard reference conditions of air ISO 6358 (20°C, 1bar).

Conversion to other densities and temperatures refer to Vol. 1: "Technical Fundamentals".

