

Rosemount™ 1056

Dual-Input Intelligent Analyzer



Essential Instructions

READ THIS PAGE BEFORE PROCEEDING!

Your instrument purchase from Emerson is one of the finest available for your particular application. These instruments have been designed, and tested to meet many national and international standards. Experience indicates that its performance is directly related to the quality of the installation and knowledge of the user in operating and maintaining the instrument. To ensure their continued operation to the design specifications, personnel should read this manual thoroughly before proceeding with installation, commissioning, operation, and maintenance of this instrument. If this equipment is used in a manner not specified by the manufacturer, the protection provided by it against hazards may be impaired.

- Failure to follow the proper instructions may cause any one of the following situations to occur: Loss of life; personal injury; property damage; damage to this instrument; and warranty invalidation.
- Ensure that you have received the correct model and options from your purchase order. Verify that this manual covers your model and options. If not, call 1-800-854-8257 or 949-757-8500 to request correct manual.
- For clarification of instructions, contact your Rosemount representative.
- Follow all warnings, cautions, and instructions marked on and supplied with the product.
- Use only qualified personnel to install, operate, update, program and maintain the product.
- Educate your personnel in the proper installation, operation, and maintenance of the product.
- Install equipment as specified in the Installation section of this manual. Follow appropriate local and national codes. Only connect the product to electrical and pressure sources specified in this manual.
- Use only factory documented components for repair. Tampering or unauthorized substitution of parts and procedures can affect the performance and cause unsafe operation of your process.
- All equipment doors must be closed and protective covers must be in place unless qualified personnel are performing maintenance.



▲ WARNING

RISK OF ELECTRICAL SHOCK

- Equipment protected throughout by double insulation.
- Installation and servicing of this product may expose personnel to dangerous voltages.
- Main power wired to separate power source must be disconnected before servicing.
- Do not operate or energize instrument with case open!
- Signal wiring connected in this box must be rated at least 240 V.
- Non-metallic cable strain reliefs do not provide grounding between conduit connections! Use grounding type bushings and jumper wires.
- Unused cable conduit entries must be securely sealed by non-flammable closures to provide enclosure integrity in compliance with personal safety and environmental protection requirements. Unused conduit openings must be sealed with NEMA 4X or IP65 conduit plugs to maintain the ingress protection rating (NEMA 4X).
- Electrical installation must be in accordance with the National Electrical Code (ANSI/NFPA-70) and/or any other applicable national or local codes.
- Operate only with front panel fastened and in place.
- Safety and performance require that this instrument be connected and properly grounded through a three-wire power source.
- Proper use and configuration is the responsibility of the user.

▲ CAUTION

This product generates, uses, and can radiate radio frequency energy and thus can cause radio communication interference. Improper installation, or operation, may increase such interference. As temporarily permitted by regulation, this unit has not been tested for compliance within the limits of Class A computing devices, pursuant to Subpart J of Part 15, of FCC Rules, which are designed to provide reasonable protection against such interference. Operation of this equipment in a residential area may cause interference, in which case the user at his own expense, will be required to take whatever measures may be required to correct the interference.

▲ CAUTION

This product is not intended for use in the light industrial, residential or commercial environments per the instrument's certification to EN50081-2.

Quick Start Guide

Rosemount 1056 Dual-Input Intelligent Analyzer

1. Refer to Section 2.0 for mechanical installation instructions.
2. Wire sensor(s) to the signal boards. See Section 3.0 for wiring instructions. Refer to the sensor instruction sheet for additional details. Make current output, alarm relay and power connections.
3. Once connections are secured and verified, apply power to the analyzer.

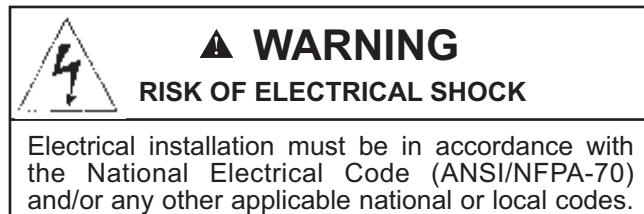

4. When the analyzer is powered up for the first time, **Quick Start** screens appear. Quick Start operating tips are as follows:
 - a. A **backlit** field shows the position of the cursor.
 - b. To move the cursor left or right, use the keys to the left or right of the ENTER key. To scroll up or down or to increase or decrease the value of a digit use the keys above and below the ENTER key. Use the left or right keys to move the decimal point.
 - c. Press ENTER to store a setting. Press EXIT to leave without storing changes. Pressing EXIT during Quick Start returns the display to the initial start-up screen (select language).
5. Complete the steps as shown in the Quick Start Guide flow diagram, Fig. A on the following page.
6. After the last step, the main display appears. The outputs are assigned to default values.
7. To change output, and temperature-related settings, go to the main menu and choose **Program**. Follow the prompts. For a general guide to the Program menu, see the Quick Reference Guide, Fig.B.
8. To return the analyzer to the default settings, choose **Reset Analyzer** under the Program menu.

Quick Start Guide

Figure A. Quick Start Guide

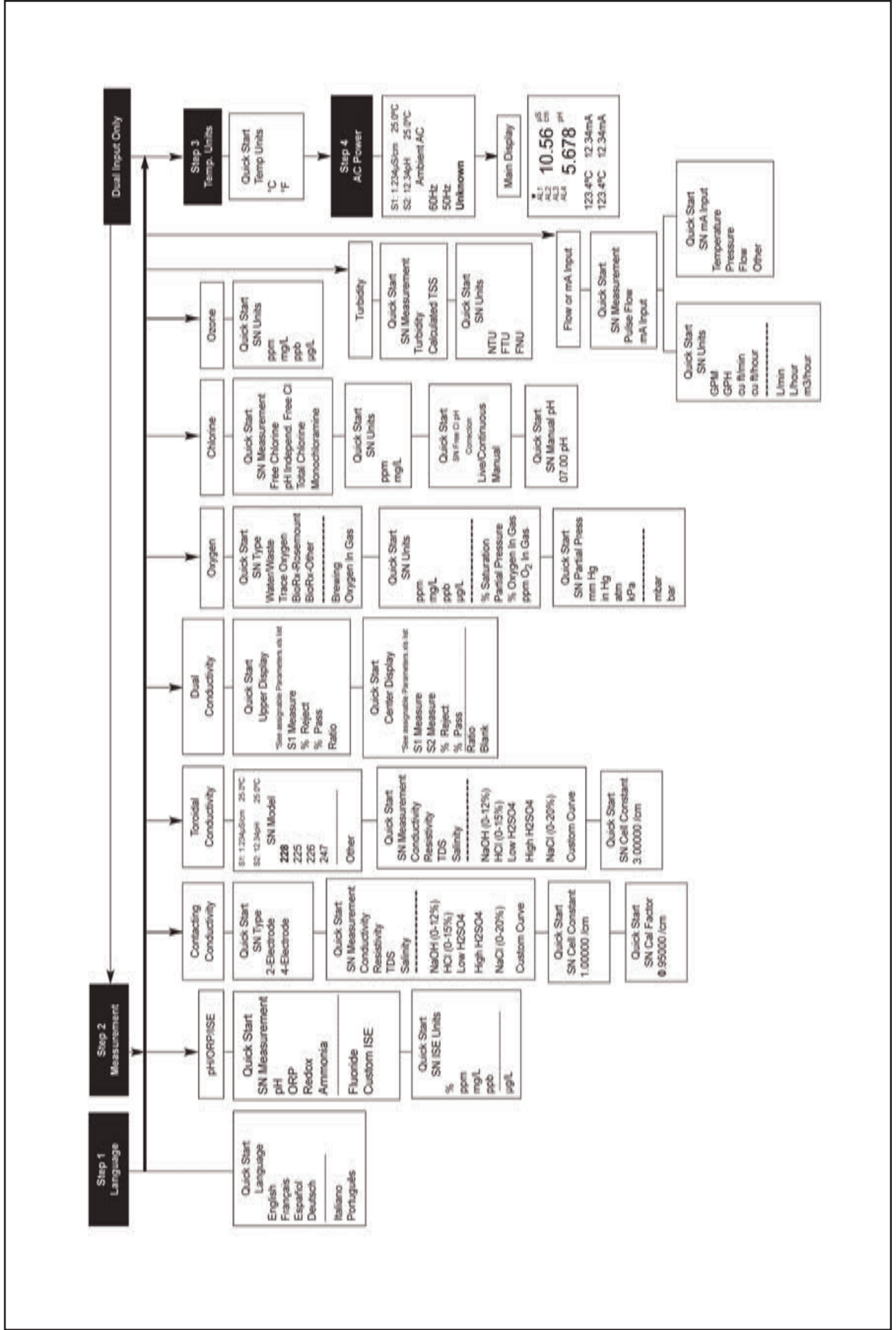

Quick Reference Guide

Figure B. Model 1056 Menu Tree

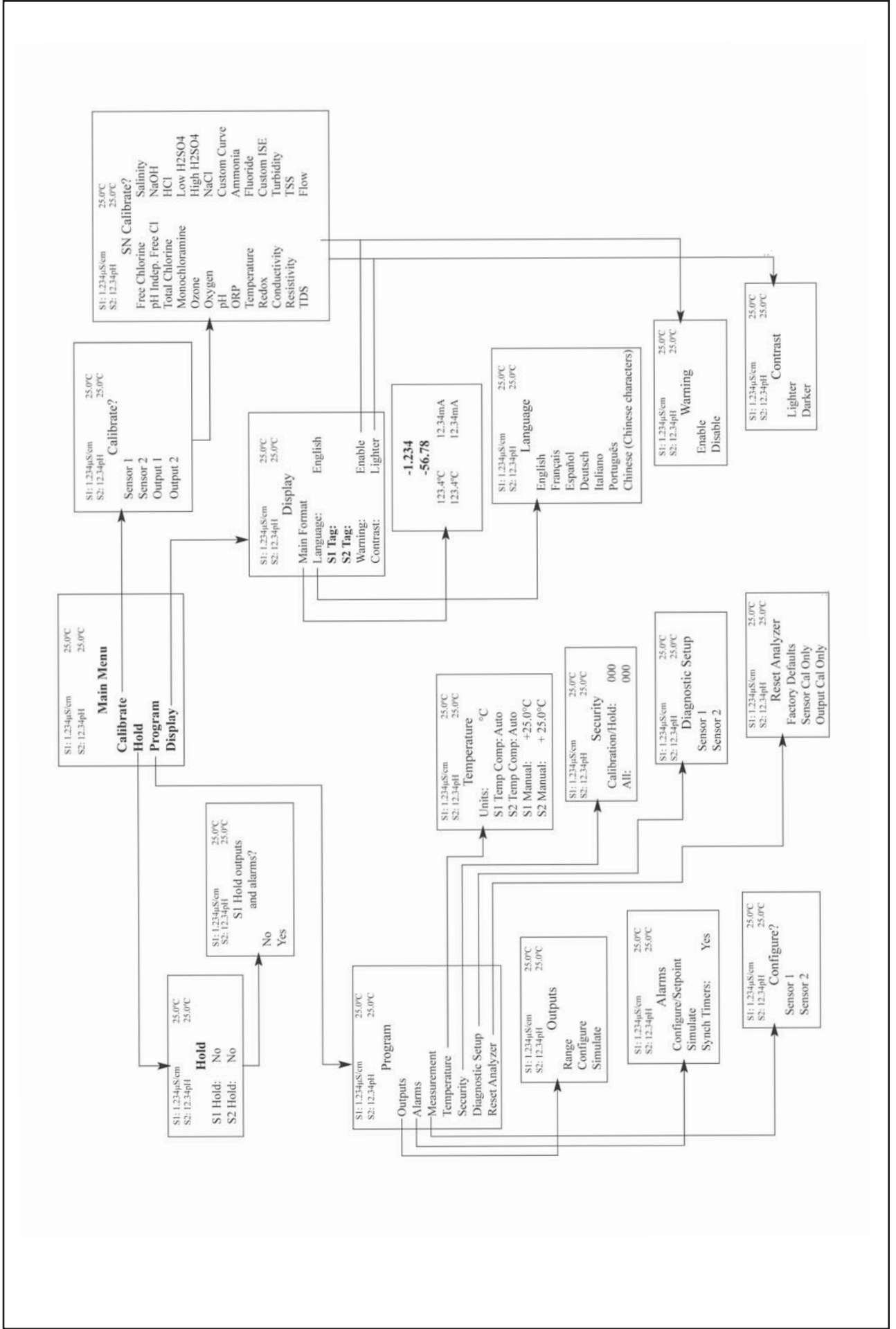

About This Document

This manual contains instructions for installation and operation of the Rosemount 1056 Dual Input Intelligent Analyzer. The following list provides notes concerning all revisions of this document.

<u>Rev. Level</u>	<u>Date</u>	<u>Notes</u>
A	01/07	This is the initial release of the product manual. The manual has been reformatted to reflect the Emerson documentation style and updated to reflect any changes in the product offering.
B	2/07	Added CE mark to p.2. Replaced Quick Start Fig A.
C	9/07	Revised Sections 1,3,5,6, and 7. Added new measurements and features - Turbidity, Flow, Current Input, Alarm relays and 4-electrode conductivity.
D	11/07	Added 24VDC power supply to Sec. 3.4. Added CSA and FM agency approvals for option codes -01, 20, 21, 22, 24, 25, 26, 30, 31, 32, 34, 35, 36 and 38.
E	05/08	Add HART and Profibus DP digital communication to Section 1 specifications.
F	08/08	Updates
G	09/08	FM and CSA agency approval, Class 1, Div 2. for 24 VDC and AC switching power supplies.
H	04/10	Update DNV logo and company name
I	03/12	Update addresses - mail and web
J	05/14	Update enclosure information
K	04/17	Updated Address and Emerson Logo. Also, updated CE declarations.

MODEL 1056 DUAL INPUT INTELLIGENT ANALYZER

TABLE OF CONTENTS

	QUICK START GUIDE	
	QUICK REFERENCE GUIDE	
	TABLE OF CONTENTS	
Section	Title	Page
1.0	DESCRIPTION AND SPECIFICATIONS	1
2.0	INSTALLATION	11
2.1	Unpacking and Inspection.....	11
2.2	Installation.....	11
3.0	WIRING	21
3.1	General	21
3.2	Preparing Conduit Openings.....	21
3.3	Preparing Sensor Cable	22
3.4	Power, Output, Alarms and Sensor Connections.....	22
4.0	DISPLAY AND OPERATION	29
4.1	User Interface	29
4.2	Instrument Keypad.....	29
4.3	Main Display	30
4.4	Menu System.....	31
5.0	PROGRAMMING – BASICS	33
5.1	General	33
5.2	Changing the StartUp Settings	33
5.3	Choosing Temperature units and Automatic/Manual Temperature Compensation ..	34
5.4	Configuring and Ranging the Current Outputs.....	34
5.5	Setting a Security Code	36
5.6	Security Access.....	37
5.7	Using Hold	37
5.8	Resetting Factory Defaults – Reset Analyzer	38
5.9	Alarm Relays.....	39
6.0	PROGRAMMING - MEASUREMENTS	43
6.1	Programming Measurements – Introduction	43
6.2	pH	44
6.3	ORP	45
6.4	Contacting Conductivity	47
6.5	Toroidal Conductivity.....	50
6.6	Chlorine.....	53
	6.6.1 Free Chlorine	53
	6.6.2 Total Chlorine	55
	6.6.3 Monochloramine	56
	6.6.4 pH-independent Free Chlorine	57
6.7	Oxygen.....	59
6.8	Ozone	60

TABLE OF CONTENTS CONT'D

6.9	Turbidity	62
6.10	Flow	65
6.11	Current Input	66
7.0	CALIBRATION	77
7.1	Calibration – Introduction	77
7.2	pH Calibration	78
7.3	ORP Calibration	80
7.4	Contacting Conductivity Calibration	81
7.5	Toroidal Conductivity Calibration	84
7.6	Chlorine Calibration	86
	7.6.1 Free Chlorine	86
	7.6.2 Total Chlorine	88
	7.6.3 Monochloramine	90
	7.6.4 pH-Independent Free Chlorine	92
7.7	Oxygen Calibration	94
7.8	Ozone Calibration	97
7.9	Temperature Calibration.....	99
7.10	Turbidity	100
7.11	Pulse Flow	102
8.0	RETURN OF MATERIAL	115
	Warranty.....	115
	EC DECLARATION OF CONFORMITY	117

Section 1.0

Description and Specifications

- MULTI-PARAMETER INSTRUMENT – single or dual input. Choose from pH/ORP/ISE, Resistivity/Conductivity, % Concentration, Chlorine, Oxygen, Ozone, Temperature, Turbidity, Flow, and 4-20mA Current Input.
- LARGE DISPLAY – large easy-to-read process measurements.
- EASY TO INSTALL – modular boards, removable connectors, easy to wire power, sensors, and outputs.
- INTUITIVE MENU SCREENS with advanced diagnostics and help screens.
- SEVEN LANGUAGES included: English, French, German, Italian, Spanish, Portuguese, and Chinese.
- HART® AND PROFIBUS® DP Digital Communications options

1.1 Features and Applications

The 1056 dual-input analyzer offers single or dual sensor input with an unrestricted choice of dual measurements. This multi-parameter instrument offers a wide range of measurement choices supporting most industrial, commercial, and municipal applications. The modular design allows signal input boards to be field replaced making configuration changes easy. Conveniently, live process values are always displayed during programming and calibration routines.

Quick Start Programming: Exclusive Quick Start screens appear the first time the 1056 is powered. The instrument auto-recognizes each measurement board and prompts the user to configure each sensor loop in a few quick steps for immediate deployment.

Digital Communications: HART and Profibus DP digital communications are available. The 1056 HART units communicate with the Model 375 HART® handheld communicator and HART hosts, such as AMS Intelligent Device Manager. Model 1056 Profibus units are fully compatible with Profibus DP networks and Class 1 or Class 2 masters. HART and Profibus DP configured units will support any single or dual measurement configuration of Model 1056.

Menus: Menu screens for calibrating and programming are simple and intuitive. Plain language prompts and help screens guide the user through these procedures.

Dual Sensor Input and Output: The 1056 accepts single or dual sensor input. Standard 0/4-20 mA current outputs can be programmed to correspond to any measurement or temperature.

Enclosure: The instrument fits standard ½ DIN panel cutouts. The versatile enclosure design supports panel-mount, pipe-mount, and surface/wall-mount installations.

Isolated Inputs: Inputs are isolated from other signal sources and earth ground. This ensures clean signal inputs for single and dual input configurations. For dual input configurations, isolation allows any combination of measurements and signal inputs without cross-talk or signal interference.

Temperature: Most measurements require temperature compensation. The 1056 will automatically recognize Pt100, Pt1000 or 22k NTC RTDs built into the sensor.

Security Access Codes: Two levels of security access are available. Program one access code for routine calibration and hold of current outputs; program another access code for all menus and functions.

Diagnostics: The analyzer continuously monitors itself and the sensor(s) for problematic conditions. The display flashes Fault and/or Warning when these conditions occur.

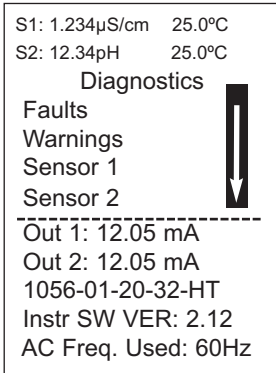

Information about each condition is quickly accessible by pressing DIAG on the keypad. User help screens are displayed for most fault and warning conditions to assist in troubleshooting.

Display: The high-contrast LCD provides live measurement readouts in large digits and shows up to four additional process variables or diagnostic parameters. The display is back-lit and the format can be customized to meet user requirements.

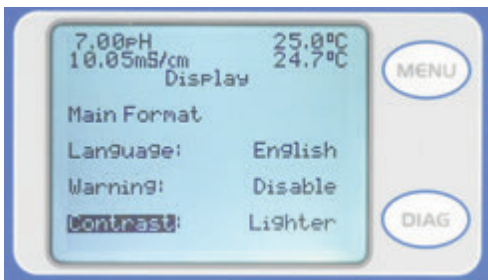

LOCAL LANGUAGES:

Rosemount extends its worldwide reach by offering seven local languages – English, French, German, Italian, Spanish, Portuguese, and Chinese. Every unit includes user programming menus; calibration routines; faults and warnings; and user help screens in all seven languages. The displayed language can be easily set and changed using the menus.



CURRENT OUTPUTS: Two 4-20 mA or 0-20 mA current outputs are electrically isolated. Outputs are fully scalable and can be programmed to linear or logarithmic modes. Output dampening can be enabled with time constants from 0 to 999 seconds. Output 1 includes digital signal 4-20 mA superimposed HART (option -HT only)

Special Measurements: The Model 1056 offers measuring capabilities for many applications.

● **Single or Dual Turbidity:** Ideal in municipal applications for measurement of low-NTU filtered drinking water. Must be used with Clarity II sensor, sensor cable and debubbler.



● **4-Electrode Conductivity:**

The 1056 is compatible with Rosemount 4-electrode Model 410VP in the PUR-SENSE family of conductivity sensors. This sensor supports a wide array of applications and is capable of measuring a large range of conductivity with one geometric configuration. Wired to the 1056, this sensor can measure 2µS/cm to 300mS/cm with an accuracy of 4% of reading throughout the entire range.

● **4-20mA Current Input:** Accepts any analog current input from an external device for temperature compensation of measurements and atmospheric pressure input for partial pressure correction of oxygen.

● **Selective Ions:** The analyzer is able to measure ammonia and fluoride using commercially available ion-selective electrodes. All analyzers with installed pH boards can be programmed to measure selective ions.

● **pH Independent Free Chlorine:** With Rosemount 498CI-01 sensor, the analyzer is able to measure free chlorine with automatic correction for process pH without the need for a pH sensor.

● **Inferential pH:** The analyzer is able to derive and display inferred pH (pHCalc) using two contacting conductivity signal boards and the appropriate contacting conductivity sensors. This method will calculate the pH of condensate and boiler water from conductivity and cation conductivity measurements.

● **Differential Conductivity:** Dual input conductivity configurations can measure differential conductivity. The analyzer can be programmed to display dual conductivity as ratio, % rejection, or % passage.

1.2 Specifications - General

Enclosure: Polycarbonate. Type 4X, IP65.

Note: To ensure a water-tight seal, tighten all four front panel screws to 6 in-lbs of torque



Dimensions: Overall 155 x 155 x 131mm (6.10 x 6.10 x 5.15 in.). Cutout: 1/2 DIN 139mm x 139mm (5.45 x 5.45 in.)

Conduit Openings: Accepts 1/2" or PG13.5 conduit fittings

Display: Monochromatic graphic liquid crystal display. 128 x 96 pixel display resolution. Backlit. Active display area: 58 x 78mm (2.3 x 3.0 in.).

Ambient Temperature and Humidity: 0 to 55°C (32 to 131°F). Turbidity only: 0 to 50°C (32 to 122°F), RH 5 to 95% (non-condensing)

Hazardous Location Approvals -

Options for CSA: 01, 02, 03, 20, 21, 22, 24, 25, 26, 27, 30, 31, 32, 34, 35, 36, 37, 38, AN, DP and HT.



-LR 34186
Class I, Division 2, Groups A, B, C, & D
Class II, Division 2, Groups E, F, & G
Class III T4A Tamb= 50 °C
Type 4X, IP66 Enclosure

Non-Incendive Field Wiring (NIFW) may be used when installed per drawing 1400325. The 'C' and 'US' indicators adjacent to the CSA Mark signify that the product has been evaluated to the applicable CSA and ANSI/UL Standards, for use in Canada and the U.S. respectively.

Evaluated to CSA Standard 22.2 No. 0-10, 0.4-04, 25-1996, 94-M1991, 142-M1987, 213-M1987, 60529-2005/2015.

ANSI/IEC 60529-2004/2011. ANSI/ISA 12.12.01:2007. UL No. 50, 11th Ed., 508 17th Ed.

Options for FM: 01, 02, 03, 20, 21, 22, 24, 25, 26, 30, 31, 32, 34, 35, 36, 38, AN, and HT. 01 power supply not available with turbidity sensor options.



Class I, Division 2, Groups A, B, C, & D
Class II & III, Division 2, Groups E, F, & G
T4A -20°C ≤ Tamb ≤ +50°C
Enclosure Type 4X

Non-Incendive Field Wiring (NIFW) may be used when installed per drawing 1400324. Evaluated to FM standards 3600:1998, 3611:2004, 3810:2005, ANSI/NEMA 250:2003.

Storage Temperature Effect: -20 to 60 °C (-4 to 140 °F)

POLLUTION DEGREE 2: Normally only non-conductive pollution occurs. Occasionally, however, a temporary conductivity caused by condensation must be expected. Altitude: for use up to 2000 meter (6562 ft.)

Power: Code -01: 115/230 VAC ±15%, 50/60 Hz. 10W.

Code -02: 20 to 30 VDC. 15 W.

Code -03: 85 to 265 VAC, 47.5 to 65.0 Hz, switching. 15 W.

Note: Code -02 and -03 power supplies include four programmable relays

Equipment protected by double insulation

RFI/EMI: EN 61326-1

LVD: EN 61010-1



Alarms relays*: Four alarm relays for process measurement(s) or temperature. Any relay can be configured as a fault alarm instead of a process alarm. Each relay can be configured independently and each can be programmed with interval timer settings.

Relays: Form C, SPDT, epoxy sealed



Maximum Relay Current	
	Resistive
28 VDC	5.0 A
115 VAC	5.0 A
230 VAC	5.0 A

Inductive load: 1/8 HP motor (max.), 120/240 VAC

*Relays only available with 02 power supply (20 - 30 VDC) or 03 switching power supply (85 - 265 VAC)

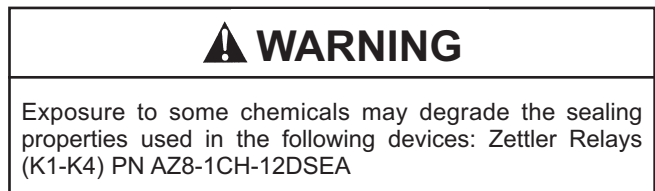

Inputs: One or two isolated sensor inputs

Outputs: Two 4-20 mA or 0-20 mA isolated current outputs. Fully scalable. Max Load: 550 Ohm. Output 1 has superimposed HART signal (1056-0X-2X-3X-HT only)

Current Output Accuracy: ±0.05 mA @ 25 °C

Terminal Connections Rating:

Power connector (3-leads): 24-12 AWG wire size.
Signal board terminal blocks: 26-16 AWG wire size.
Current output connectors (2-leads): 24-16 AWG wire size.

Alarm relay terminal blocks: 24-12 AWG wire size (-02 24 VDC power supply and -03 85-265VAC power supply)

Weight/Shipping Weight:

(rounded up to nearest lb or nearest 0.5 kg):
3 lbs/4 lbs (1.5 kg/2.0 kg)

1.3 Contacting Conductivity (Code -20 and -30)

Measures conductivity in the range 0 to 600,000 $\mu\text{S}/\text{cm}$ (600mS/cm). Measurement choices are conductivity, resistivity, total dissolved solids, salinity, and % concentration. The % concentration selection includes the choice of five common solutions (0-12% NaOH, 0-15% HCl, 0-20% NaCl, and 0-25% or 96-99.7% H_2SO_4).

The conductivity concentration algorithms for these solutions are fully temperature compensated. Three temperature compensation options are available: manual slope ($X\%/^{\circ}\text{C}$), high purity water (dilute sodium chloride), and cation conductivity (dilute hydrochloric acid). Temperature compensation can be disabled, allowing the analyzer to display raw conductivity. For more information concerning the use and operation of the contacting conductivity sensors, refer to the product data sheets.

Note: When two contacting conductivity sensors are used, Model 1056 can derive an inferred pH value called pHCalc. pHCalc is calculated pH, not directly measured pH. (Model 1056-0X-20-30-AN required)

Note: Selected 4-electrode, high-range contacting conductivity sensors are compatible with Model 1056.

Input filter: time constant 1 - 999 sec, default 2 sec.

Response time: 3 seconds to 100% of final reading

Salinity: uses Practical Salinity Scale

Total Dissolved Solids: Calculated by multiplying conductivity at 25 $^{\circ}\text{C}$ by 0.65

Temperature Specifications:

Temperature range	0-150 $^{\circ}\text{C}$
Temperature Accuracy, Pt-1000, 0-50 $^{\circ}\text{C}$	$\pm 0.1^{\circ}\text{C}$
Temperature Accuracy, Pt-1000, Temp. > 50 $^{\circ}\text{C}$	$\pm 0.5^{\circ}\text{C}$

Recommended Sensors For Conductivity

All Rosemount ENDURANCE Model 400 series conductivity sensors (Pt 1000 RTD) and Model 410 sensor.

PUR-SENSE™



PUR-SENSE™ family
4-electrode sensors



ENDURANCE™ series of
conductivity sensors

Performance Specifications

Recommended Range – Contacting Conductivity

Cell Constant	0.01 $\mu\text{S}/\text{cm}$	0.1 $\mu\text{S}/\text{cm}$	1.0 $\mu\text{S}/\text{cm}$	10 $\mu\text{S}/\text{cm}$	100 $\mu\text{S}/\text{cm}$	1000 $\mu\text{S}/\text{cm}$	10mS/cm	100mS/cm	1000mS/cm
0.01	0.01 $\mu\text{S}/\text{cm}$ to 200 $\mu\text{S}/\text{cm}$					200 $\mu\text{S}/\text{cm}$ to 6000 $\mu\text{S}/\text{cm}$			
0.1	0.1 $\mu\text{S}/\text{cm}$ to 2000 $\mu\text{S}/\text{cm}$					2000 $\mu\text{S}/\text{cm}$ to 60mS/cm			
1.0	1 $\mu\text{S}/\text{cm}$ to 20mS/cm					20mS/cm to 600mS/cm			
4-electrode	2 $\mu\text{S}/\text{cm}$ to 300mS/cm								

Cell Constant Linearity

- $\pm 0.6\%$ of reading in recommended range
- +2 to -10% of reading outside high recommended range
- $\pm 5\%$ of reading outside low recommended range
- $\pm 4\%$ of reading in recommended range

1.4 Toroidal Conductivity (Code -21 and -31)

Measures conductivity in the range of 1 (one) $\mu\text{S/cm}$ to 2,000,000 $\mu\text{S/cm}$ (2 S/cm), Measurement choices are conductivity, resistivity, total dissolved solids, salinity, and % concentration. The % concentration selection includes the choice of five common solutions (0-12% NaOH, 0-15% HCl, 0-20% NaCl, and 0-25% or 96-99.7% H_2SO_4). The conductivity concentration algorithms for these solutions are fully temperature compensated. For other solutions, a simple-to-use menu allows the customer to enter his own data. The analyzer accepts as many as five data points and fits either a linear (two points) or a quadratic function (three or more points) to the data. Two temperature compensation options are available: manual slope ($X\%/^{\circ}\text{C}$) and neutral salt (dilute sodium chloride). Temperature compensation can be disabled, allowing the analyzer to display raw conductivity. Reference temperature and linear temperature slope may also be adjusted for optimum results. For more information concerning the use and operation of the toroidal conductivity sensors, refer to the product data sheets.

Repeatability: $\pm 0.25\% \pm 5 \mu\text{S/cm}$ after zero cal

Input filter: time constant 1 - 999 sec, default 2 sec.

Response time: 3 seconds to 100% of final reading

Salinity: uses Practical Salinity Scale

Total Dissolved Solids: Calculated by multiplying conductivity at 25°C by 0.65

Temperature Specifications:

Temperature range	-25 to 210°C (-13 to 410°F)
Temperature Accuracy, Pt-100, -25 to 50°C	$\pm 0.5^{\circ}\text{C}$
Temperature Accuracy, Pt-100, 50 to 210°C	$\pm 1^{\circ}\text{C}$

Recommended Sensors

All Rosemount submersion/immersion and flow-through toroidal sensors.



High performance toroidal conductivity sensors
Models 226 and 225

Performance Specifications

Recommended Range - Toroidal Conductivity

Model	$1\mu\text{S/cm}$	$10\mu\text{S/cm}$	$100\mu\text{S/cm}$	$1000\mu\text{S/cm}$	10mS/cm	100mS/cm	1000mS/cm	2000mS/cm
226	• • •	5 $\mu\text{S/cm}$ to 500mS/cm					500mS/cm to 2000mS/cm	
225 & 228	• • • • • • • • • •	15 $\mu\text{S/cm}$ to 1500mS/cm					1500mS/cm to 2000mS/cm	
242		100 $\mu\text{S/cm}$ to 2000mS/cm						
222 (1in & 2in)		500 $\mu\text{S/cm}$ to 2000mS/cm						

LOOP PERFORMANCE (Following Calibration)

=====	Model 226: $\pm 1\%$ of reading $\pm 5 \mu\text{S/cm}$ in recommended range
=====	Models 225 & 228: $\pm 1\%$ of reading $\pm 10 \mu\text{S/cm}$ in recommended range
=====	Models 222,242: $\pm 4\%$ of reading in recommended range
-----	Model 225, 226 & 228: $\pm 5\%$ of reading outside high recommended range
• • • • • • • • • •	Model 226: $\pm 5 \mu\text{S/cm}$ outside low recommended range
• • • • • • • • • •	Models 225 & 228: $\pm 15 \mu\text{S/cm}$ outside low recommended range

1.5 pH/ORP/ISE (Code -22 and -32)

For use with any standard pH or ORP sensor. Measurement choices are pH, ORP, Redox, ammonia, fluoride or custom ISE. The automatic buffer recognition feature uses stored buffer values and their temperature curves for the most common buffer standards available worldwide. The analyzer will recognize the value of the buffer being measured and perform a self stabilization check on the sensor before completing the calibration. Manual or automatic temperature compensation is menu selectable. Change in pH due to process temperature can be compensated using a programmable temperature coefficient. For more information concerning the use and operation of the pH or ORP sensors, refer to the product data sheets.

Model 1056 can also derive an inferred pH value called pHCalc (calculated pH). pHCalc can be derived and displayed when two contacting conductivity sensors are used. (Model 1056-0X-20-30-AN)

Performance Specifications (pH Input)

Measurement Range [pH]: 0 to 14 pH

Accuracy: ± 0.01 pH

Diagnostics: glass impedance, reference impedance

Temperature coefficient: ± 0.002 pH/ °C

Solution temperature correction: pure water, dilute base and custom.

Buffer recognition: NIST, DIN 19266, JIS 8802, BSI, DIN19267, Ingold, and Merck.

Input filter: time constant 1 - 999 seconds, default 4 seconds.

Response time: 5 seconds to 100%

Temperature Specifications:

Temperature range	0-150 °C
Temperature Accuracy, Pt-100, 0-50 °C	± 0.5 °C
Temperature Accuracy, Temp. > 50 °C	± 1 °C

Performance Specifications (ORP Input)

Measurement Range [ORP]: -1500 to +1500 mV

Accuracy: ± 1 mV

Temperature coefficient: ± 0.12 mV / °C

Input filter: time constant 1 - 999 seconds, default 4 seconds.

Response time: 5 seconds to 100% of final reading

RECOMMENDED SENSORS FOR pH:

All standard pH sensors.

RECOMMENDED SENSORS FOR ORP:

All standard ORP sensors.



1.6 Flow (Code -23 and -33)

For use with most pulse signal flow sensors, the 1056 user-selectable units of measurement include flow rates in GPM (Gallons per minute), GPH (Gallon per hour), cu ft/min (cubic feet per min), cu ft/hour (cubic feet per hour), LPM (liters per minute), LPH (liters per hour), or m³/hr (cubic meters per hour), and velocity in ft/sec or m/sec. When configured to measure flow, the unit also acts as a totalizer in the chosen unit (gallons, liters, or cubic meters).

Dual flow instruments can be configured as a % recovery, flow difference, flow ratio, or total (combined) flow.

Performance Specifications

Frequency Range: 3 to 1000 Hz

Flow Rate: 0 - 99,999 GPM, LPM, m³/hr, GPH, LPH, cu ft/min, cu ft/hr.

Totalized Flow: 0 – 9,999,999,999,999 Gallons or m³, 0 – 999, 999,999,999 cu ft.

Accuracy: 0.5%

Input filter: time constant 0-999 sec., default 5 sec.

Recommended Sensors*

+GF+ Signet 515 Rotor-X Flow sensor

* Input voltage not to exceed ±36V

1.7 4-20mA Current Input (Code -23 and -33)

For use with any transmitter or external device that transmits 4-20mA or 0-20mA current outputs. Typical uses are for temperature compensation of live measurements (except ORP, turbidity and flow) and for continuous atmospheric pressure input for determination of partial pressure, needed for compensation of live dissolved oxygen measurements. External input of atmospheric pressure for DO measurement allows continuous partial pressure compensation while the Model 1056 enclosure is completely sealed. (The pressure transducer component on the DO board can only be used for calibration when the case is open to atmosphere.)

Externally sourced current input is also useful for calibration of new or existing sensors that require temperature measurement or atmospheric pressure inputs (DO only).

For externally sourced temp or pressure compensation, the user must program the 1056 to input the 4-20mA current signal from the external device.

In addition to live continuous compensation of live measurements, the current input board can also be used simply to display the measured temperature. or the calculated partial pressure from the external device.

This feature leverages the large display variables on the Model 1056 as a convenience for technicians. Temperature can be displayed in degrees C or degrees F. Partial pressure can be displayed in inches Hg, mm Hg, atm (atmospheres), kPa (kiloPascals), bar or mbar.

The current input board can be used with devices that do not actively power their 4-20mA output signals. The Model 1056 actively powers to the + and – lines of the current input board to enable current input from a 4-20mA output device.

Note: this Model 1056 signal input board (23, 33 model option code) also includes flow measurement functionality. The signal board, however, must be configured to measure either mA current input or flow.

PERFORMANCE SPECIFICATIONS

Measurement Range *[mA]: 0-20 or 4-20

Accuracy: ±0.03mA

Input filter: time constant 0-999 sec., default 5 sec.

*Current input not to exceed 22mA

1.8 Chlorine (Code -24 and -34)

Free and Total Chlorine

The 1056 is compatible with the 499ACL-01 free chlorine sensor and the 499ACL-02 total chlorine sensor. The 499ACL-02 sensor must be used with the TCL total chlorine sample conditioning system. The 1056 fully compensates free and total chlorine readings for changes in membrane permeability caused by temperature changes. For free chlorine measurements, both automatic and manual pH correction are available. For automatic pH correction select code 32 and an appropriate pH sensor. For more information concerning the use and operation of the amperometric chlorine sensors and the TCL measurement system, refer to the product data sheets.

Performance Specifications

Resolution: 0.001 ppm or 0.01 ppm – selectable
Input Range: 0 nA – 100 μ A
Automatic pH correction (requires Code P): 6.0 to 10.0 pH
Temperature compensation: Automatic (via RTD) or manual (0-50°C).
Input filter: time constant 1 - 999 sec, default 5 sec.
Response time: 6 seconds to 100% of final reading

Recommended Sensors*

Chlorine: Model 499ACL-01 Free Chlorine or Model 499ACL-02 Total Residual Chlorine
pH: The following pH sensors are recommended for automatic pH correction of free chlorine readings: Models: 399-09-62, 399-14, and 399VP-09

Monochloramine

The Model 1056 is compatible with the Model 499A CL-03 Monochloramine sensor. The Model 1056 fully compensates readings for changes in membrane permeability caused by temperature changes. Because monochloramine measurement is not affected by pH of the process, no pH sensor or correction is required. For more information concerning the use and operation of the amperometric chlorine sensors, refer to the product data sheets.

Performance Specifications

Resolution: 0.001 ppm or 0.01 ppm – selectable
Input Range: 0nA – 100 μ A
Temperature compensation: Automatic (via RTD) or manual (0-50°C).
Input filter: time constant 1 - 999 sec, default 5 sec.
Response time: 6 seconds to 100% of final reading

Recommended Sensors

Rosemount Model 499ACL-03 Monochloramine sensor

pH-Independent Free Chlorine

The 1056 is compatible with the Model 498CL-01 pH-independent free chlorine sensor. The Model 498CL-01 sensor is intended for the continuous determination of free chlorine (hypochlorous acid plus hypochlorite ion) in water. The primary application is measuring chlorine in drinking water. The sensor requires no acid pre-treatment, nor is an auxiliary pH sensor required for pH correction. The Model 1056 fully compensates free chlorine readings for changes in membrane permeability caused by temperature. For more information concerning the use and operation of the amperometric chlorine sensors, refer to the product data sheets.

Performance Specifications

Resolution: 0.001 ppm or 0.01 ppm – selectable
Input Range: 0 nA – 100 μ A
Automatic pH correction: 6.5 to 10.0 pH
Temperature compensation: Automatic (via RTD) or manual (0-50°C).
Input filter: time constant 1 - 999 sec, default 5 sec.
Response time: 6 seconds to 100% of final reading

Recommended Sensors

Rosemount Model 498CL-01 pH independent free chlorine sensor



Chlorine sensors with Variopool connection
and cable connection
Model 498CL-01

1.9 Dissolved Oxygen (Code -25 and -35)

The 1056 is compatible with the 499ADO, 499ATrDO, Hx438, and Gx438 dissolved oxygen sensors and the 4000 percent oxygen gas sensor. The 1056 displays dissolved oxygen in ppm, mg/L, ppb, µg/L, % saturation, % O₂ in gas, ppm O₂ in gas. The analyzer fully compensates oxygen readings for changes in membrane permeability caused by temperature changes. An atmospheric pressure sensor is included on all dissolved oxygen signal boards to allow automatic atmospheric pressure determination at the time of calibration. If removing the sensor from the process liquid is impractical, the analyzer can be calibrated against a standard instrument. Calibration can be corrected for process salinity. For more information on the use of amperometric oxygen sensors, refer to the product data sheets.

Performance Specifications

Resolution: 0.01 ppm; 0.1 ppb for 499A TrDO sensor (when O₂ <1.00 ppm); 0.1%

Input Range: 0 nA – 100 µA

Temperature Compensation: Automatic (via RTD) or manual (0-50 °C).

Input filter: time constant 1 - 999 sec, default 5 sec.

Response time: 6 seconds to 100% of final reading

Recommended Sensors

Rosemount amperometric membrane and steam-sterilizable sensors listed above



Dissolved Oxygen sensor with Variopool connection
Model 499ADO

1.10 Dissolved Ozone (Code -26 and -36)

The 1056 is compatible with the Model 499AOZ sensor. The 1056 fully compensates ozone readings for changes in membrane permeability caused by temperature changes. For more information concerning the use and operation of the amperometric ozone sensors, refer to the product data sheets.

Performance Specifications

Resolution: 0.001 ppm or 0.01 ppm – selectable

Input Range: 0nA – 100 µA

Temperature Compensation: Automatic (via RTD) or manual (0-35°C)

Input filter: time constant 1 - 999 sec, default 5 sec.

Response time: 6 seconds to 100% of final reading

Recommended Sensor

Rosemount Model 499A OZ ozone sensor



Dissolved Ozone sensors with Polysulfone body
Variopool connection and cable connection
Model 499AOZ

1.11 Turbidity (Code 27 and 37)

The 1056 instrument is available in single and dual turbidity configurations for the Clarity II® turbidimeter. It is intended for the determination of turbidity in filtered drinking water. The other components of the Clarity II turbidimeter – sensor(s), debubbler/measuring chamber(s), and cable for each sensor must be ordered separately or as a complete system with the Model 1056.

The 1056 turbidity instrument accepts inputs from both USEPA 180.1 and ISO 7027-compliant sensors

When ordering the Model 1056 turbidity instrument, the 02 (24VDC power supply) or the 03 (switching 115/230VAC power supply) are required. Both of these power supplies include four fully programmable relays with timers.

Note: Model 1056 Turbidity must be used with Clarity II sensor, sensor cable and debubbler.

Performance Specifications

Units: Turbidity (NTU, FTU, or FNU); total suspended solids (mg/L, ppm, or no units)

Display resolution-turbidity: 4 digits; decimal point moves from x.xxx to xxx.

Display resolution-TSS: 4 digits; decimal point moves from x.xxx to xxxx

Calibration methods: user-prepared standard, commercially prepared standard, or grab sample. For total suspended solids user must provide a linear calibration equation.

Inputs: Choice of single or dual input, EPA 180.1 or ISO 7027 sensors.

Field wiring terminals: removable terminal blocks for sensor connection.

Accuracy after calibration at 20.0 NTU:

0-1 NTU $\pm 2\%$ of reading or 0.015 NTU, whichever is greater.

0-20 NTU: $\pm 2\%$ of reading.



Section 2.0 Installation

2.1 Unpacking and Inspection 2.2 Installation

2.1 Unpacking and Inspection

Inspect the shipping container. If it is damaged, contact the shipper immediately for instructions. Save the box. If there is no apparent damage, unpack the container. Be sure all items shown on the packing list are present. If items are missing, notify Emerson immediately.

2.2 Installation

2.2.1 General Information

1. Although the analyzer is suitable for outdoor use, do not install it in direct sunlight or in areas of extreme temperatures.
2. Install the analyzer in an area where vibration and electromagnetic and radio frequency interference are minimized or absent.
3. Keep the analyzer and sensor wiring at least one foot from high voltage conductors. Be sure there is easy access to the analyzer.
4. The analyzer is suitable for panel, pipe, or surface mounting. Refer to the table below.

Type of Mounting	Figure
Panel	2-1
Wall and Pipe	2-2

	WARNING RISK OF ELECTRICAL SHOCK
Electrical installation must be in accordance with the National Electrical Code (ANSI/NFPA-70) and/or any other applicable national or local codes.	

Figure 2-1 Panel Mounting Dimensions



Note: Panel mounting seal integrity (4/4X) for outdoor applications is the responsibility of the end user.

Figure 2-2 Pipe and Wall Mounting Dimensions

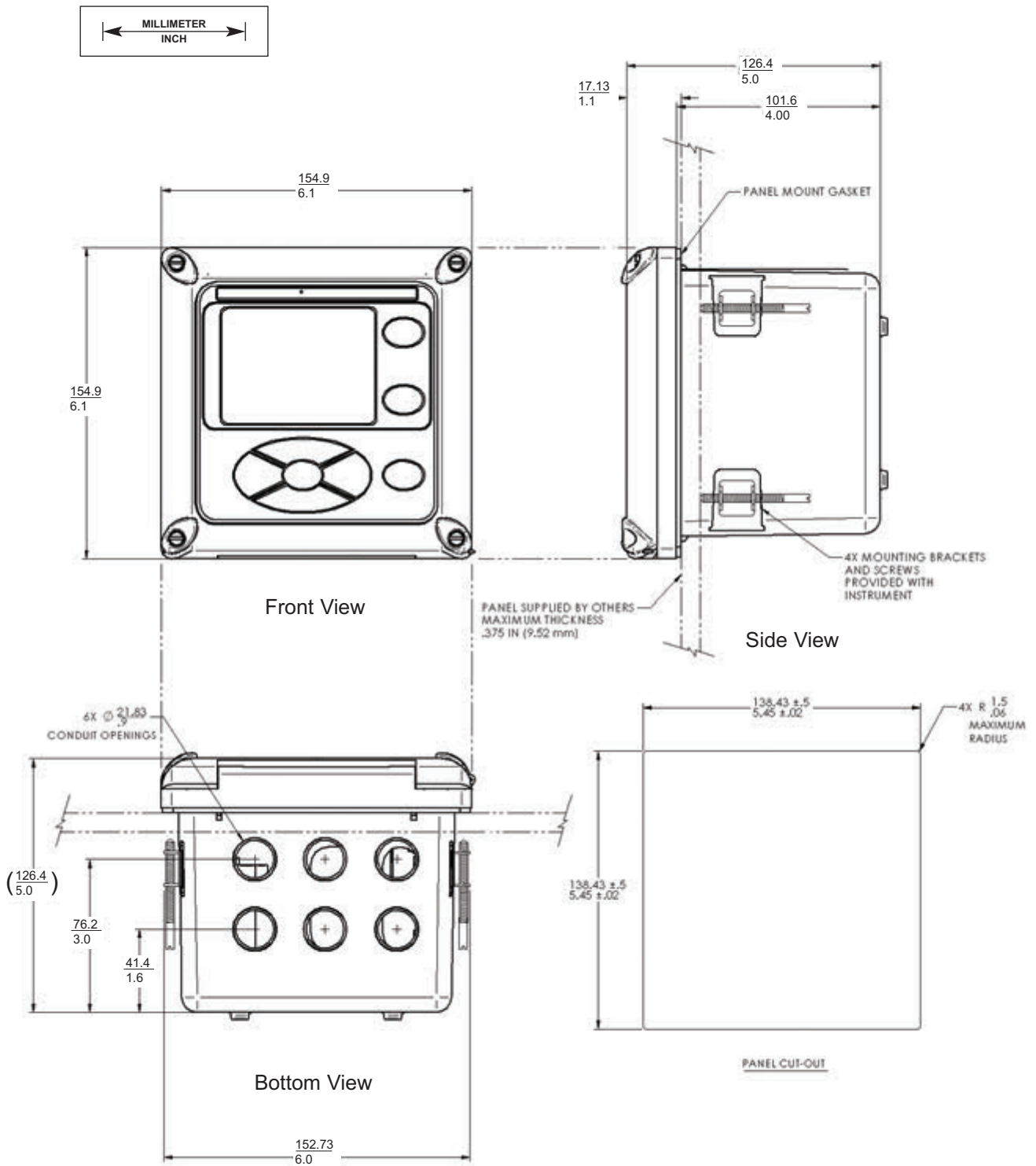
(Mounting bracket PN:23820-00)

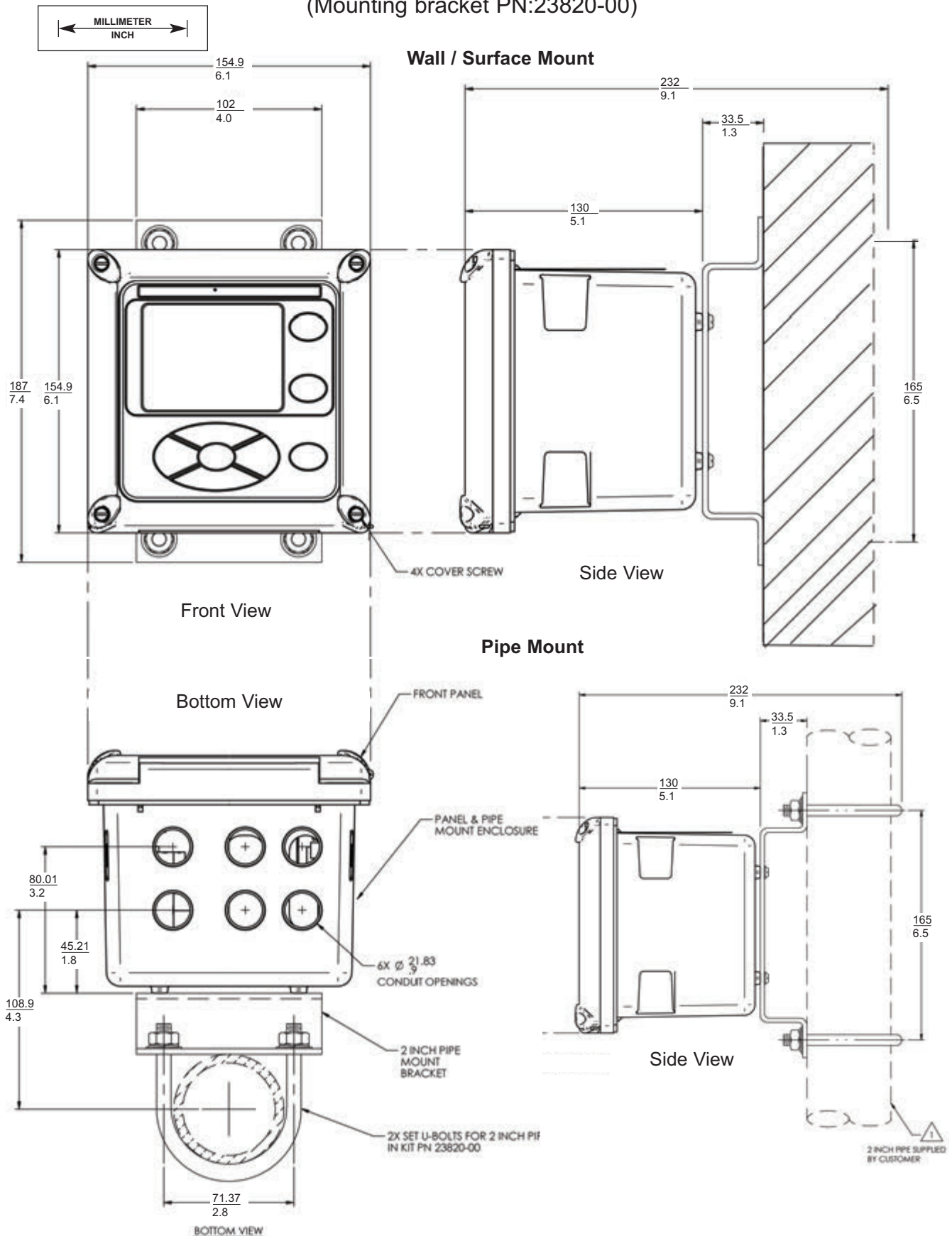

The front panel is hinged at the bottom. The panel swings down for easy access to the wiring locations.

FIGURE 2-3. FM Non Incendive Field Wiring Installation

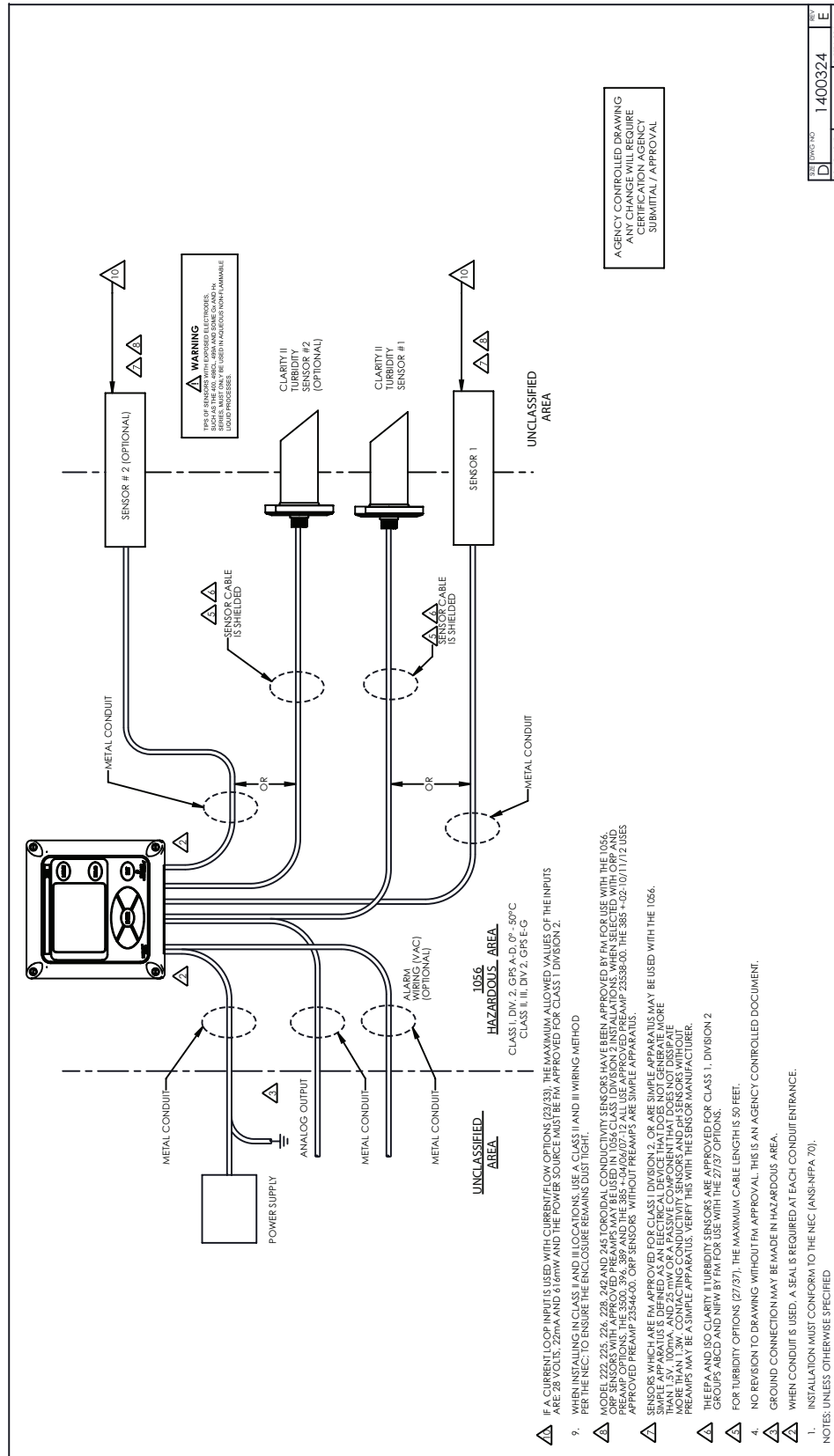

AGENCY CONTROLLED DRAWING
ANY CHANGE WILL REQUIRE
CERTIFICATION AGENCY
SUBMITTAL / APPROVAL

D	1400324	E
SCALE	1400324	SHEET OF
NO.		

- ⚠️ IF A CURRENT LOOP INPUT IS USED WITH CURRENT FLOW OPTIONS (02/03), THE MAXIMUM ALLOWED VALUES OF THE INPUTS ARE 28 VOLTS, 22mA AND 618mW AND THE POWER SOURCE MUST BE FM APPROVED FOR CLASS 1 DIVISION 2.
 - 9. WHEN INSTALLING IN CLASS I AND III LOCATIONS, USE A CLASS I AND III WIRING METHOD PER THE NEC TO ENSURE THE ENCLOSURE REMAINS DUST TIGHT.
 - ⚠️ MODEL 020, 205, 207, 208, 240 AND 245 TOP/OVAL CONDUCTIVITY SENSORS HAVE BEEN APPROVED BY FM FOR USE WITH THE 1056. CRP SENSORS WITH APPROVED PREAMS MAY BE USED IN 1056 CLASS DIVISION 2 INSTALLATIONS WHEN SELECTED WITH CRP AND PREAMP. OPTIONS THE 3500, 396, 399 AND THE 385 +04/06/07-12 ALL USE APPROVED PREAMP 23538-00. THE 385 +02-10/11/12 USES APPROVED PREAMP 23546-00. CRP SENSORS WITHOUT PREAMS ARE SIMPLE APPARATUS.
 - ⚠️ SENSORS WHICH ARE FM APPROVED FOR CLASS 1 DIVISION 2, OR ARE SIMPLE APPARATUS MAY BE USED WITH THE 1056. SENSORS WHICH ARE NOT FM APPROVED FOR CLASS 1 DIVISION 2, OR ARE NOT SIMPLE APPARATUS MUST BE USED WITH A MORE THAN 1.3W CONTACTING CONDUCTIVITY SENSORS AND PH SENSORS WITHOUT PREAMS MAY BE AS SIMPLE APPARATUS. VERIFY THIS WITH THE SENSOR MANUFACTURER.
 - ⚠️ THE EPA AND ISO CLARITY II TURBIDITY SENSORS ARE APPROVED FOR CLASS 1, DIVISION 2 GROUPS ABCD AND INFM BY FM FOR USE WITH THE 2737 OPTIONS.
 - ⚠️ FOR TURBIDITY OPTIONS (07/07), THE MAXIMUM CABLE LENGTH IS 50 FEET.
 - 4. NO REVISION TO DRAWING WITHOUT FM APPROVAL. THIS IS AN AGENCY CONTROLLED DOCUMENT.
 - ⚠️ GROUND CONNECTION MAY BE MADE IN HAZARDOUS AREA.
 - ⚠️ WHEN CONDUIT IS USED, A SEAL IS REQUIRED AT EACH CONDUIT ENTRANCE.
 - 1. INSTALLATION MUST CONFORM TO THE NEC (ANSI/NFPA 70).
- NOTES: UNLESS OTHERWISE SPECIFIED

FIGURE 2-3. CSA NonIncendive Class I, Division 2 Certified product for selected configurations

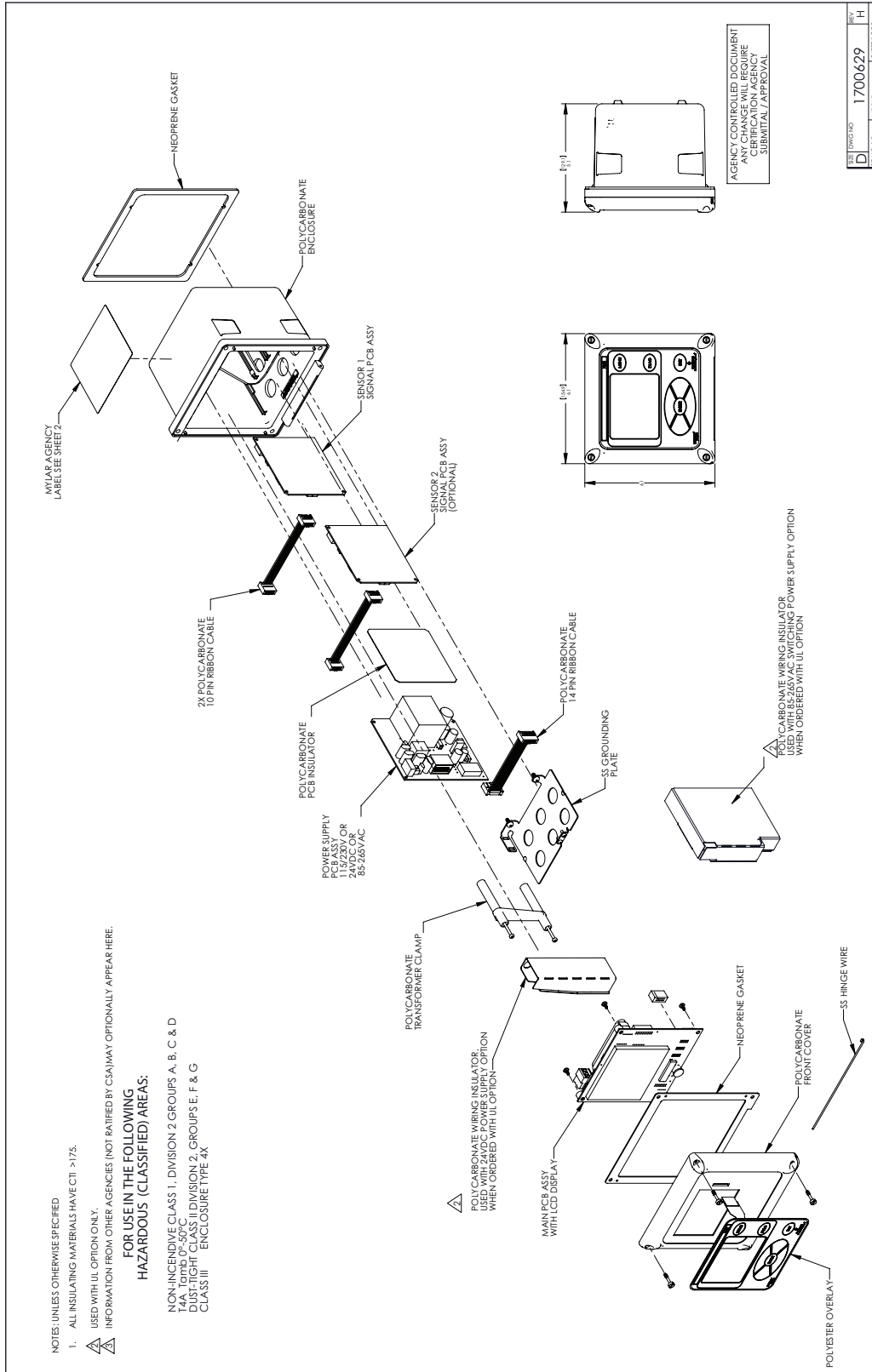

NOTES: UNLESS OTHERWISE SPECIFIED
1. ALL INSULATING MATERIALS HAVE CTI > 75.
⚠ USED WITH UL OPTION ONLY.
⚠ INFORMATION FROM OTHER AGENCIES (NOT RATIFIED BY CSA) MAY OPTIONALLY APPEAR HERE.
FOR USE IN THE FOLLOWING
HAZARDOUS (CLASSIFIED) AREAS:
NON-INCENDIVE CLASS I, DIVISION 2 GROUPS A, B, C & D
CLASS I, DIVISION 2 GROUPS E, F & G
CLASS III ENCLOSURE TYPE 4X

FIGURE 2-3. FM NonIncendive Class I, Division 2 Certified product for selected configurations

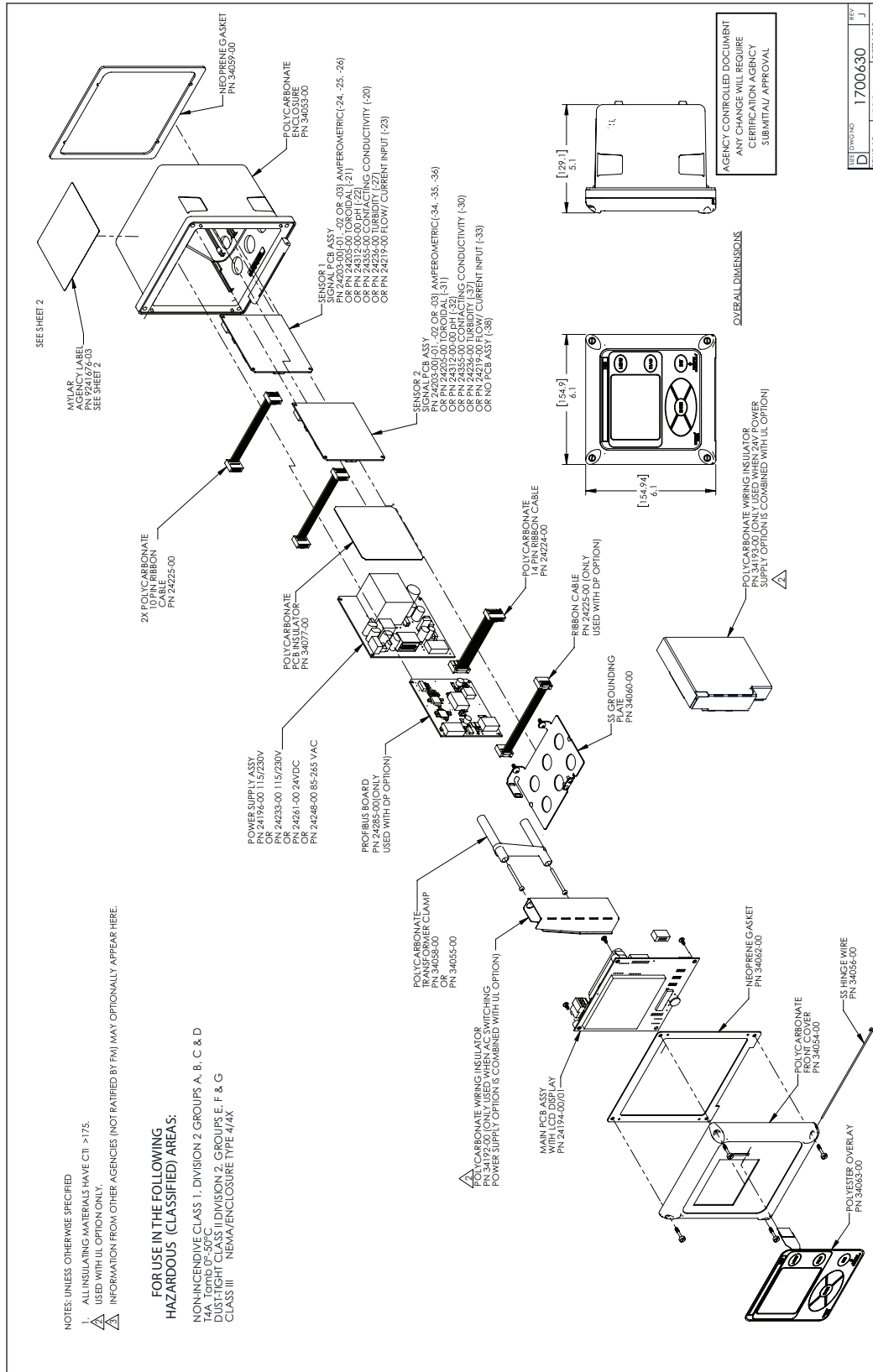

FIGURE 2-3. FM NonIncendive Class I, Division 2 Certified product for selected configurations

MODEL 1056 APPROVED OPTIONS

CODE	POWER SUPPLY
01	115/230 VAC 50/60 Hz
02	24VDC
03	115/230 VAC 50/60 Hz WITH RELAYS
CODE	MEASUREMENT 1
20	CONTACTING CONDUCTIVITY
21	TOROIDAL CONDUCTIVITY
22	PH/ORP/ISE
24	CHLORINE
25	DISSOLVED OXYGEN
36	OZONE
27	TURBIDITY
23	FLOW/CURRENT INPUT
CODE	MEASUREMENT 2
30	CONTACTING CONDUCTIVITY
31	TOROIDAL CONDUCTIVITY
32	PH/ORP/ISE
34	CHLORINE
35	DISSOLVED OXYGEN
36	OZONE
37	TURBIDITY
33	FLOW/CURRENT INPUT
38	NONE
CODE	OUTPUTS
AN	ANALOG 4-20mA
HT	HART 4-20mA
DP	PROFIBUS DP PROTOCOL
CODE	UL APPROVAL (BLANK IF NONE SELECTED)
UL	UL ORDINARY LOCATIONS APPROVAL

RECOMMENDED SENSORS*

100 SERIES CONTACTING CONDUCTIVITY SENSORS
 200 SERIES CONTACTING CONDUCTIVITY SENSORS
 300 SERIES PH SENSORS
 400 SERIES CONTACTING CONDUCTIVITY SENSORS
 500 SERIES PH SENSORS
 600 SERIES AMPEROMETRIC SENSORS
 700 SERIES PH SENSORS
 800 SERIES PH SENSORS
 900 SERIES PH SENSORS
 950 SERIES PH SENSORS
 990 SERIES PH SENSORS

IF NONINCENDIVE FIELD WIRING METHODS ARE NOT USED, THEN:
 * "YP" VERSIONS ARE NOT SUITABLE FOR USE IN CLASS I, DIV 2 HAZARDOUS (I-CLASSIFIED) AREAS.
 * SENSOR CONFIGURATIONS MUST PROVIDE CABLE PROTECTION PROVISIONS (E.G. METAL CONDUIT OR RACEWAYS) IN COMPLIANCE WITH THE NATIONAL ELECTRICAL CODE

WARNING

TIRE OF SENSORS WITH EXPOSED ELECTRODES, SUCH AS THE MODEL 400, 498CL, 497A, AND SOME G3, AND HX SERIES MUST ONLY BE USED IN AQUEOUS NON-FLAMMABLE LIQUID PROCESSES
 SEE DRAWING 1400324 FOR NEW INSTALLATION

AGENCY LABEL

CHINA RHHS LOGO MAY BE PRINTED HERE

IF OPTION 01 PRINT:
 POWER = 115 VAC ± 15%, 50Hz ± 0.5%, TOW
 POWER = 230 VAC ± 15%, 60Hz ± 0.5%, TOW

ELSE IF OPTION 02 PRINT:
 POWER = 24 VDC ± 1%, 30VDC ± 1.5%

ELSE IF OPTION 03 PRINT:
 POWER = 24 VDC ± 1%, 30VDC ± 1.5%

PRINTED IF OPTION UL

AGENCY LABEL TOP EDGE

ASSEMBLY LOCATION

1056 OPTION CODE EXAMPLES:
 1056C102HTNS

NOTES: UNLESS OTHERWISE SPECIFIED

REV D 1700630 REV J
 SCALE 1:2 SHEET 2 OF 2

Section 3.0 Wiring

- 3.1 General
- 3.2 Preparing Conduit Openings
- 3.3 Preparing Sensor Cable
- 3.4 Power, Output, and Sensor Connections

3.1 General

The 1056 is easy to wire. It includes removable connectors and slide-out signal input boards. The front panel is hinged at the bottom. The panel swings down for easy access to the wiring locations.

3.1.1. Removable connectors and signal input boards

Model 1056 uses removable signal input boards and communication boards for ease of wiring and installation. Each of the signal input boards can be partially or completely removed from the enclosure for wiring. The Model 1056 has three slots for placement of up to two signal input boards and one communication board.

Slot 1-Left	Slot 2 – Center	Slot 3 – Right
Comm. board	Input Board 1	Input Board 2

3.1.2 Signal Input Boards

Slots 2 and 3 are for signal input measurement boards. Wire the sensor leads to the measurement board following the lead locations marked on the board. After wiring the sensor leads to the signal board, carefully slide the wired board fully into the enclosure slot and take up the excess sensor cable through the cable gland. Tighten the cable gland nut to secure the cable and ensure a sealed enclosure.

3.1.3 Digital Communication Boards

HART and Profibus DP communication boards will be available in the future as options for Model 1056 digital communication with a host. The HART board supports Bell 202 digital communications over an analog 4-20mA current output. Profibus DP is an open communications protocol which operates over a dedicated digital line to the host.

3.1.4 Alarm Relays

Four alarm relays are supplied with the switching power supply (85 to 265VAC, 03 order code) and the 24VDC power supply (20-30VDC, 02 order code). All relays can be used for process measurement(s) or temperature. Any relay can be configured as a fault alarm instead of a process alarm. Each relay can be configured independently and each can be programmed as an interval timer, typically used to activate pumps or control valves. As process alarms, alarm logic (high or low activation or USP*) and deadband are user-programmable. Customer-defined failsafe operation is supported as a programmable menu function to allow all relays to be energized or not-energized as a default condition upon powering the analyzer.

The USP* alarm can be programmed to activate when the conductivity is within a user-selectable percentage of the limit. USP alarming is available only when a contacting conductivity measurement board is installed.

3.2 Preparing Conduit Openings

There are six conduit openings in all configurations of Model 1056. (Note that four of the openings will be fitted with plugs upon shipment.)

Conduit openings accept 1/2-inch conduit fittings or PG13.5 cable glands. To keep the case watertight, block unused openings with NEMA 4X or IP65 conduit plugs.

NOTE: Use watertight fittings and hubs that comply with your requirements. Connect the conduit hub to the conduit before attaching the fitting to the analyzer.

3.3 Preparing Sensor Cable

The 1056 is intended for use with all Rosemount sensors. Refer to the sensor installation instructions for details on preparing sensor cables.

3.4 Power, Output, and Sensor Connections

3.4.1 Power Wiring

Three Power Supplies are offered for Model 1056:

- a. 115/230 VAC Power Supply (-01 ordering code)
- b. 24 VDC (20 – 30V) Power Supply (-02 ordering code)
- c. 85 – 265 VAC Switching Power Supply (-03 ordering code)

AC mains (115 or 230 V) leads and 24 VDC leads are wired to the Power Supply board which is mounted vertically on the left side of the main enclosure cavity. Each lead location is clearly marked on the Power Supply board. Wire the power leads to the Power Supply board using the lead markings on the board.

The grounding plate is connected to the earth terminal of power supply input connector TB1 on the -01 (115/230 VAC) and -03 (85-265 VAC) power supplies. The green colored screws on the grounding plate are intended for connection to some sensors to minimize radio frequency interference. The green screws are not intended to be used for safety purposes.



115/230 VAC Power Supply (-01 ordering code) is shown below:

⚠ CAUTION

AC Power switch shipped in the 230 VAC position.
Adjust switch upwards to 115 VAC position for 110 VAC – 120 VAC operation.

Figure 3-1

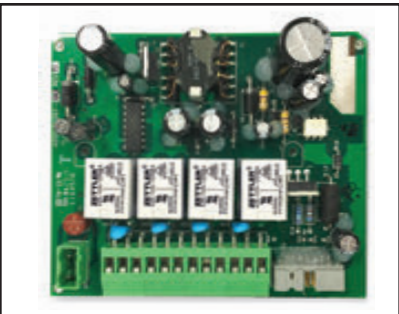

24 VDC Power Supply (-02 ordering code) is shown below:

This power supply automatically detects DC power and accepts 20 VDC to 30 VDC inputs.
Four programmable alarm relays are included.

Figure 3-2



Switching AC Power Supply (-03 ordering code) is shown below:

This power supply automatically detects AC line conditions and switches to the proper line voltage and line frequency.
Four programmable alarm relays are included.

Figure 3-3

3.4.2 Current Output Wiring

All instruments are shipped with two 4-20 mA current outputs. Wiring locations for the outputs are on the Main board which is mounted on the hinged door of the instrument. Wire the output leads to the correct position on the Main board using the lead markings (+/positive, -/negative) on the board. Male mating connectors are provided with each unit.

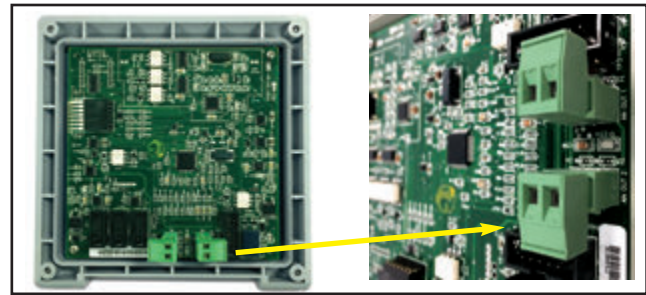

Figure 3-4

3.4.3 Alarm Relay Wiring

Four alarm relays are supplied with the switching power supply (85 to 265VAC, -03 order code) and the 24VDC power supply (20-30 VDC, -02 order code). Wire the relay leads on each of the independent relays to the correct position on the power supply board using the printed lead markings (NO/Normally Open, NC/Normally Closed, or Com/Common) on the board. See Fig 3-4.

NO1	RELAY 1	
COM1		
NC1		
NO2	RELAY 2	
COM2		
NC2		
NO3	RELAY 3	
COM3		
NC3		
NO4	RELAY 4	
COM4		
NC4		

Figure 3-5 Alarm Relay Wiring for Model 1056 Switching Power Supply (-03 Order Code)

3.4.4 Sensor Wiring to Signal Boards

Wire the correct sensor leads to the measurement board using the lead locations marked directly on the board. After wiring the sensor leads to the signal board, carefully slide the wired board fully into the enclosure slot and take up the excess sensor cable through the cable gland.

For best EMI/RFI protection use shielded output signal cable enclosed in an earth-grounded metal conduit. Connect the shield to earth ground. AC wiring should be 14 gauge or greater. Provide a switch or breaker to disconnect the analyzer from the main power supply. Install the switch or breaker near the analyzer and label it as the disconnecting device for the analyzer.

Keep sensor and output signal wiring separate from power wiring. Do not run sensor and power wiring in the same conduit or close together in a cable tray.

	<p>WARNING RISK OF ELECTRICAL SHOCK</p>
<p>Electrical installation must be in accordance with the National Electrical Code (ANSI/NFPA-70) and/or any other applicable national or local codes.</p>	

Sec. 3.4 Signal board wiring

Figure 3-6 Contacting Conductivity signal board and Sensor cable leads

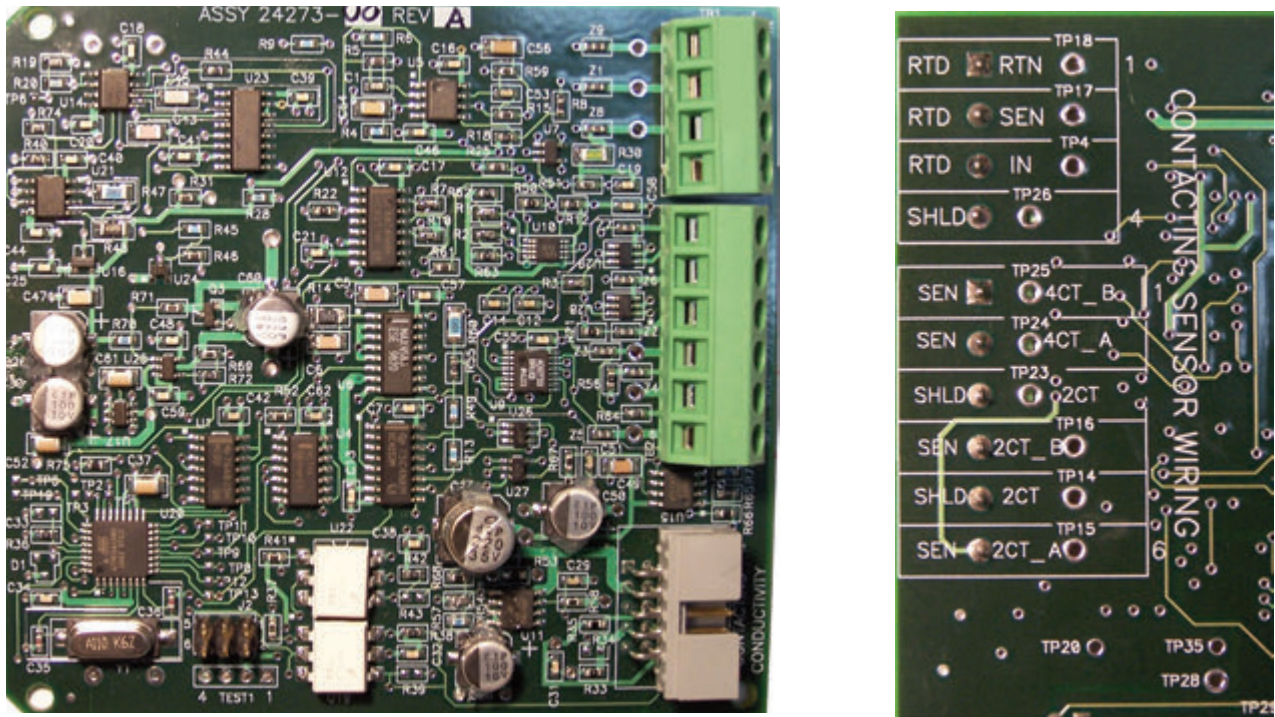

Figure 3-7 Toroidal Conductivity Signal board and Sensor cable leads

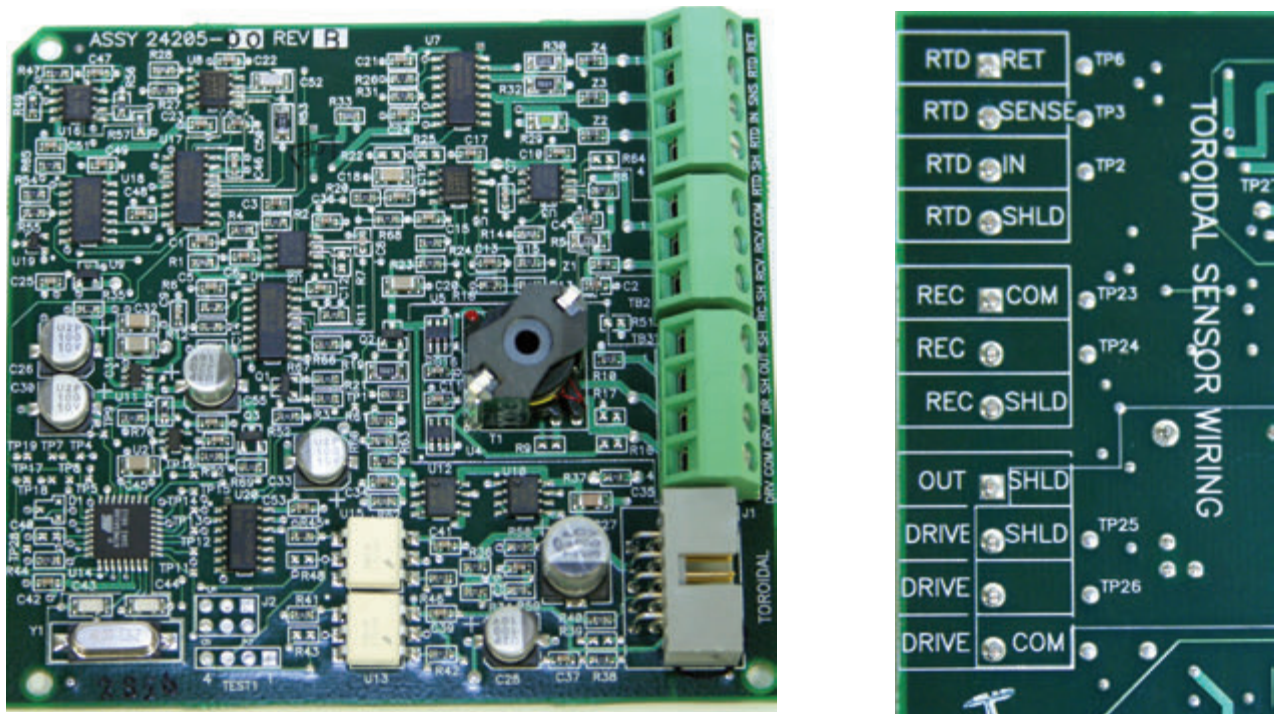

Figure 3-8 pH/ORP/ISE signal board and Sensor cable leads

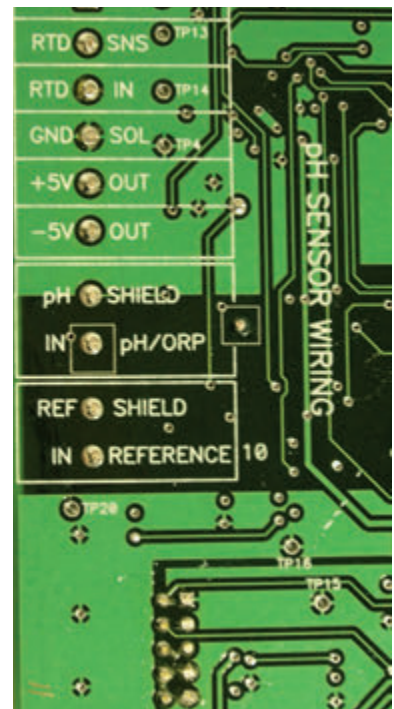
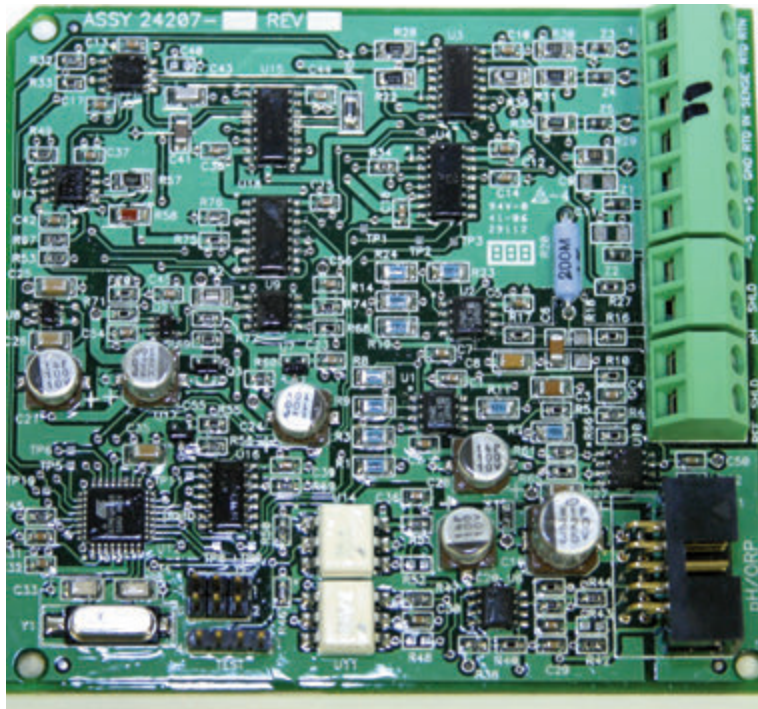

Figure 3-9 Amperometric signal (Chlorine, Oxygen, Ozone) board and Sensor cable leads

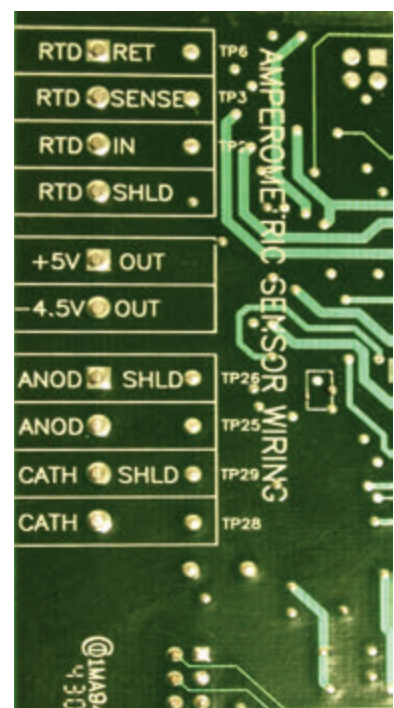
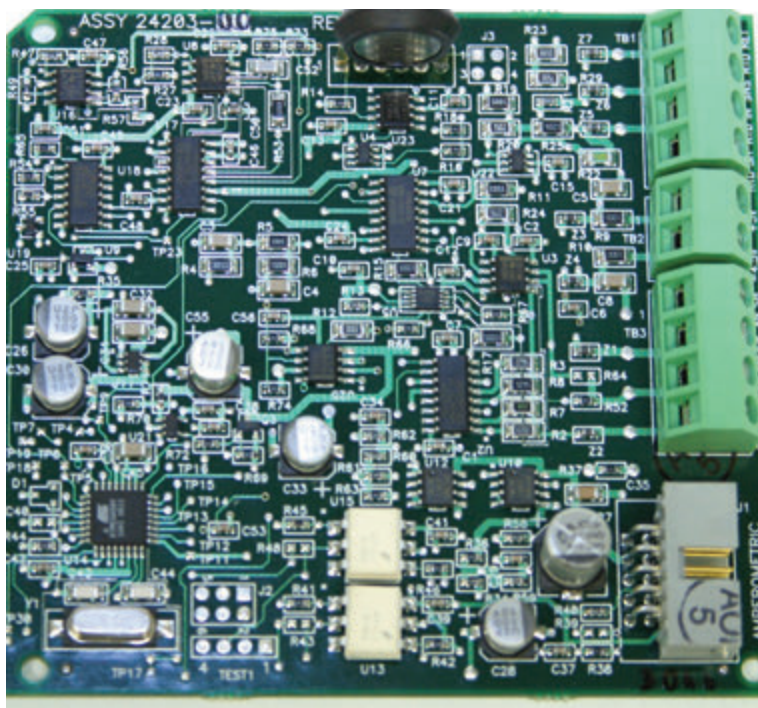

Figure 3-10 Turbidity signal board with plug-in Sensor connection

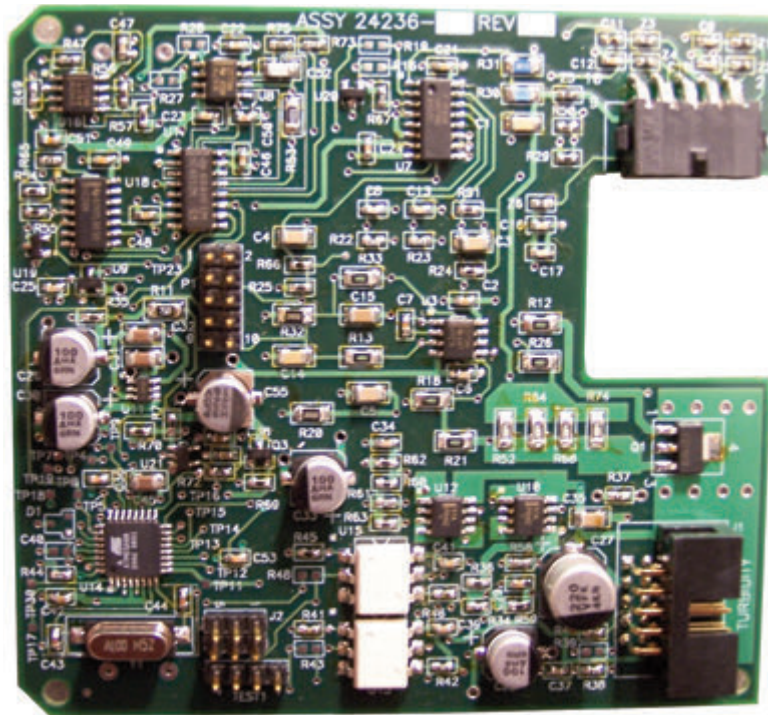
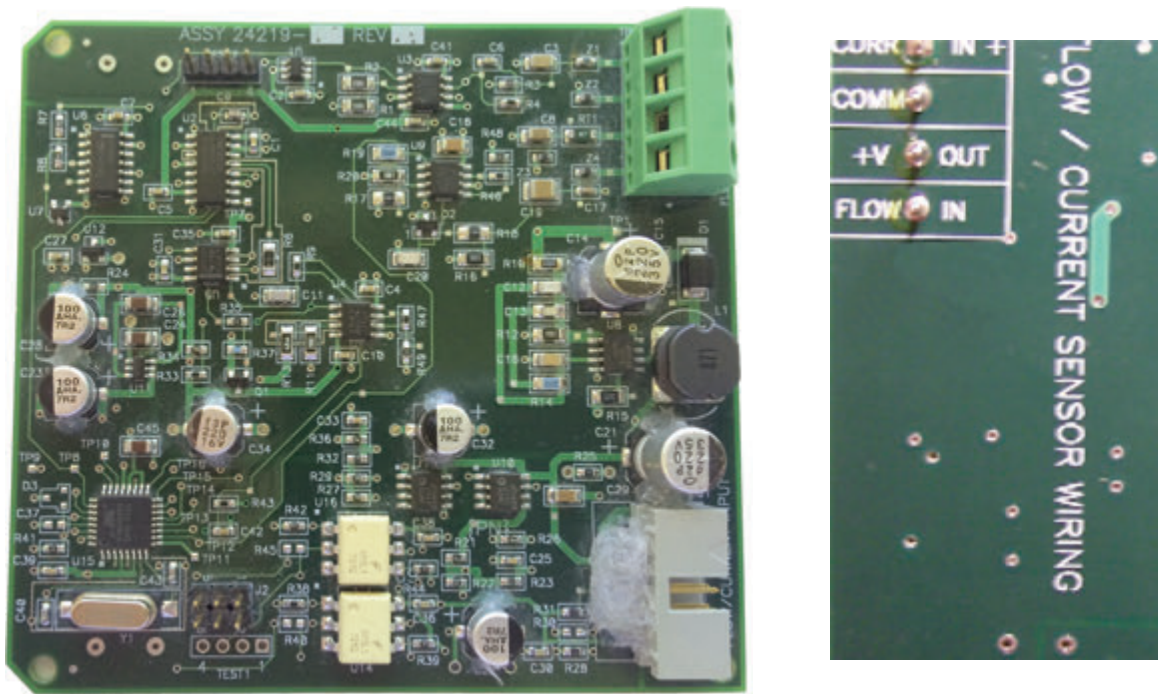
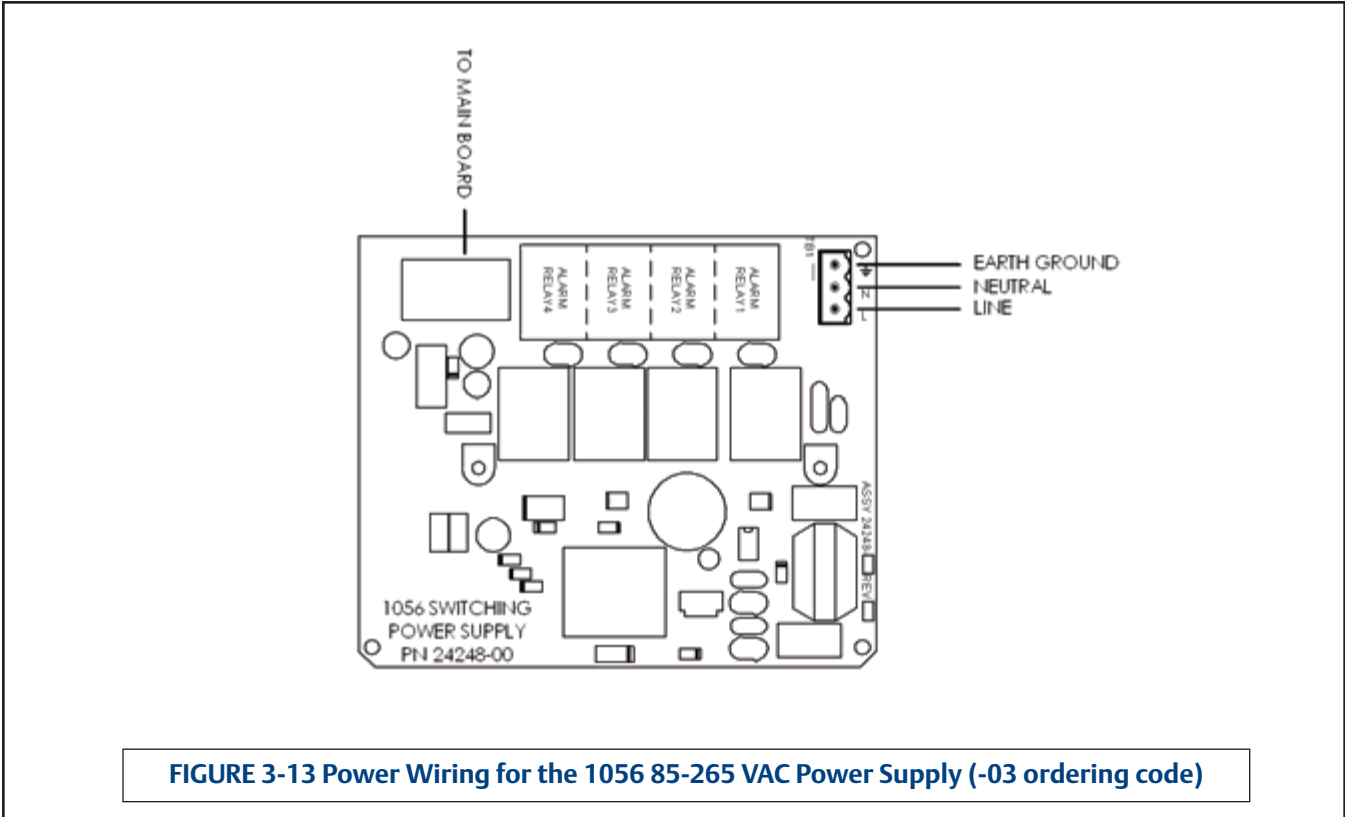
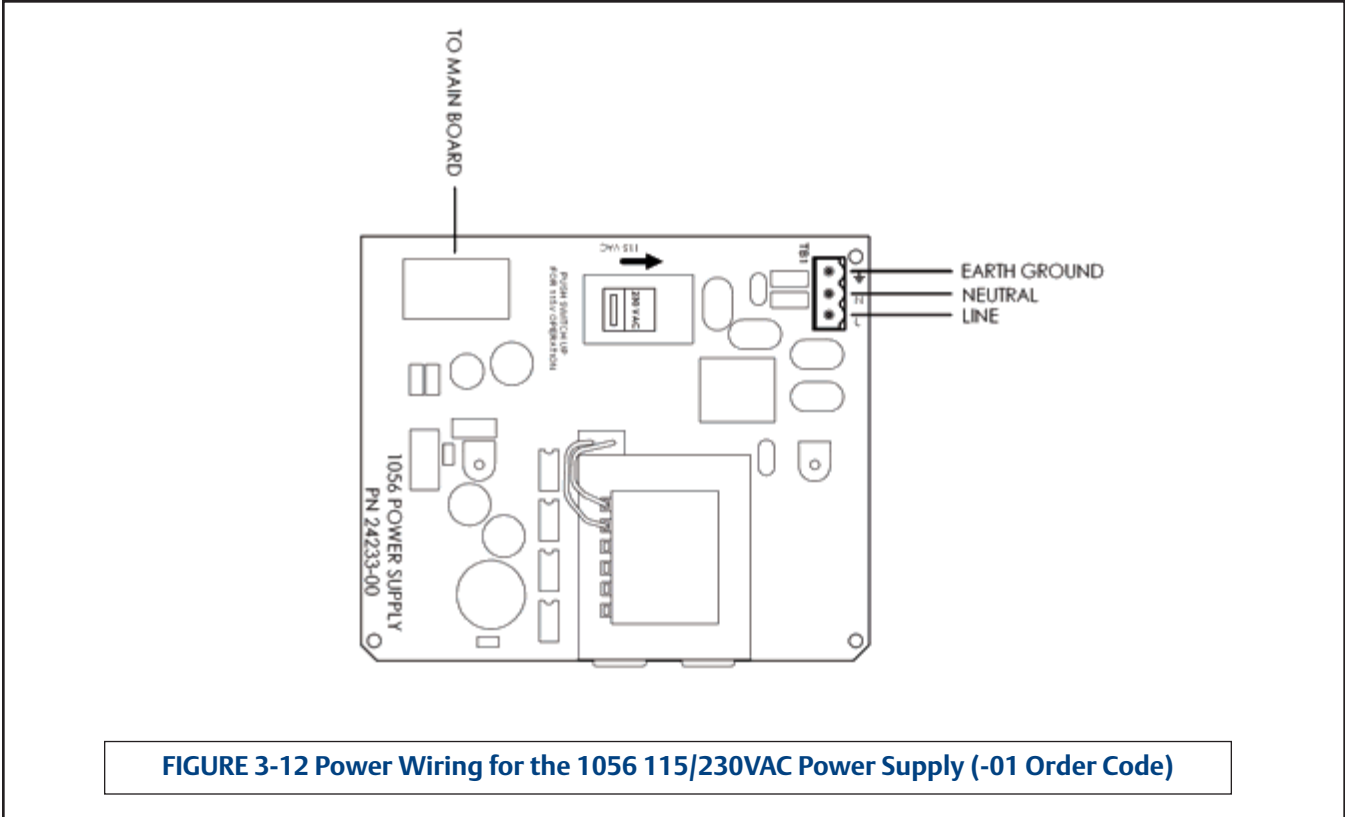

Figure 3-11 Flow/Current Input signal board and Sensor cable leads





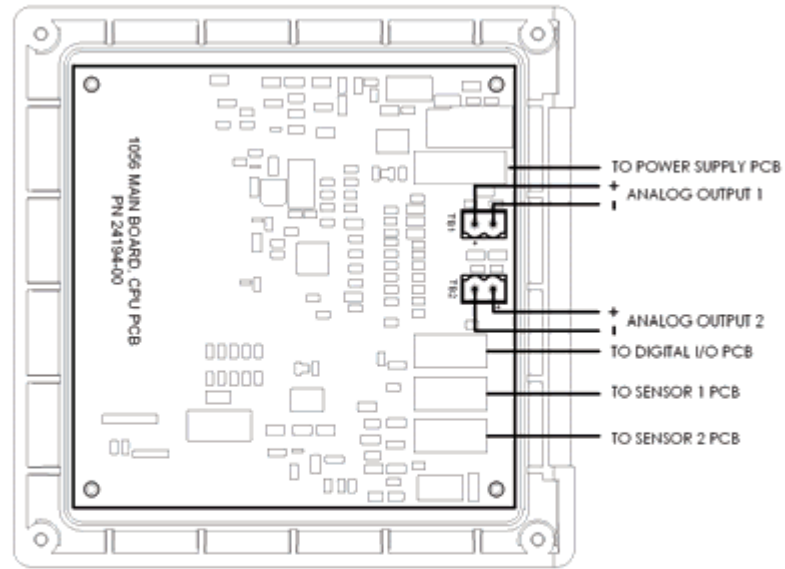

FIGURE 3-14 Output Wiring for Model 1056 Main PCB

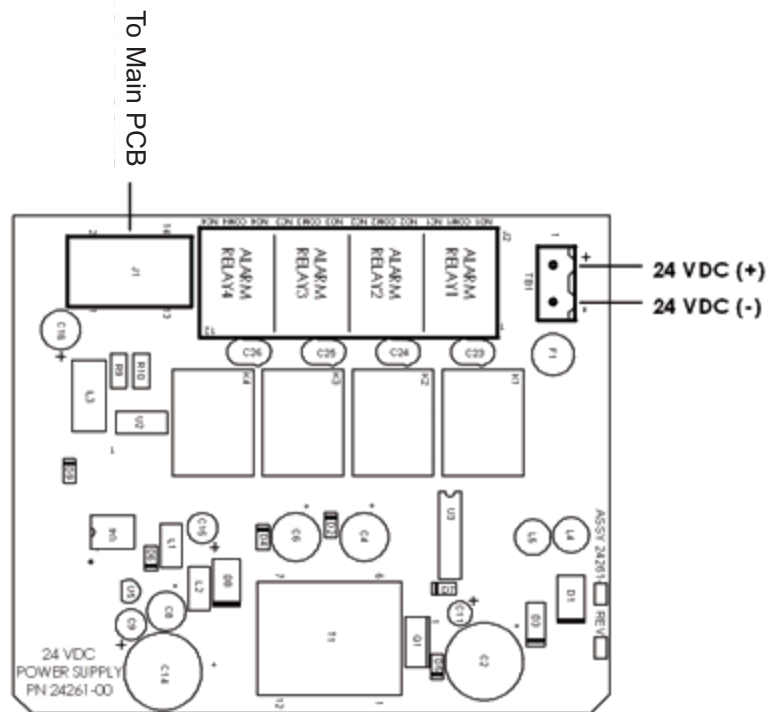

FIGURE 3-15 Power Wiring for Model 1056 24VDC Power Supply (-02 ordering code)

Section 4.0 Display and Operation

- 4.1 User Interface
- 4.2 Keypad
- 4.3 Main Display
- 4.4 Menu System

4.1 User Interface

The 1056 has a large display which shows two live measurement readouts in large digits and up to four additional process variables or diagnostic parameters concurrently. The display is back-lit and the format can be customized to meet user requirements. The intuitive menu system allows access to Calibration, Hold (of current outputs), Programming, and Display functions by pressing the MENU button. In addition, a dedicated DIAGNOSTIC button is available to provide access to useful operational information on installed sensor(s) and any problematic conditions that might occur. The display flashes Fault and/or Warning when these conditions occur. Help screens are displayed for most fault and warning conditions to guide the user in troubleshooting.

During calibration and programming, key presses cause different displays to appear. The displays are self-explanatory and guide the user step-by-step through the procedure.



4.2 Instrument Keypad

There are 4 Function keys and 4 Selection keys on the instrument keypad.

Function keys:

The **MENU key** is used to access menus for programming and calibrating the instrument. Four top-level menu items appear when pressing the MENU key:

- **Calibrate:** calibrate attached sensors and analog outputs.
- **Hold:** Suspend current outputs.
- **Program:** Program outputs, measurement, temperature, security and reset.
- **Display:** Program display format, language, warnings, and contrast

Pressing MENU always causes the main menu screen to appear. Pressing MENU followed by EXIT causes the main display to appear.

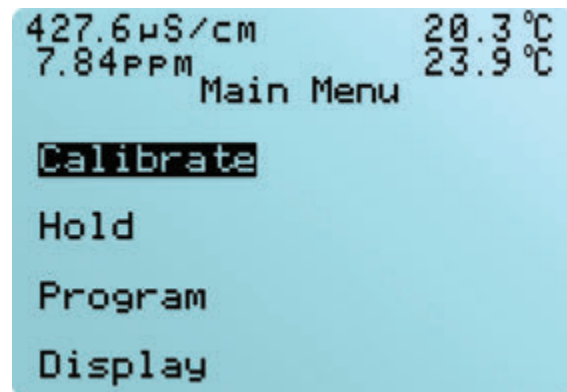

Pressing the **DIAG** key displays active Faults and Warnings, and provides detailed instrument information and sensor diagnostics including: Faults, Warnings, Sensor 1 and 2 information, Out 1 and Out 2 live current values, Instrument Software version, and AC frequency used. Pressing ENTER on Sensor 1 or Sensor 2 provides useful diagnostics and information (as applicable): Measurement, Sensor Type, Raw signal value, Cell constant, Zero Offset, Temperature, Temperature Offset, selected measurement range,

Cable Resistance, Temperature Sensor Resistance, Signal Board software version.

The ENTER key. Pressing ENTER stores numbers and settings and moves the display to the next screen.

The EXIT key. Pressing EXIT returns to the previous screen without storing changes.

Selection keys:

Surrounding the ENTER key, four Selection keys – up, down, right and left, move the cursor to all areas of the screen while using the menus.

Selection keys are used to:

1. select items on the menu screens
2. scroll up and down the menu lists.
3. enter or edit numeric values.
4. move the cursor to the right or left
5. select measurement units during operations

4.3 Main Display

The Model 1056 displays one or two primary measurement values, up to four secondary measurement values, a fault and warning banner, alarm relay flags, and a digital communications icon.



Process measurements:

Two process variables are displayed if two signal boards are installed. One process variable and process temperature is displayed if one signal board is installed with one sensor. The Upper display area shows the Sensor 1 process reading. The Center display area shows the Sensor 2 process reading. For dual conductivity, the Upper and Center display areas can be assigned to different process variables as follows:

Process variables for Upper display- example:	Process variables for Center display- example:
Measure 1	Measure 1
% Reject	Measure 2
% Pass	% Reject
Ratio	% Pass
	Ratio
	Blank

For single input configurations, the Upper display area shows the live process variable and the Center display area can be assigned to Temperature or blank.

Secondary values:

Up to four secondary values are shown in four display quadrants at the bottom half of the screen. All four secondary value positions can be programmed by the user to any display parameter available. Possible secondary values include:

Displayable Secondary Values	
Slope 1	Man Temp 2
Ref Off 1	Output 1 mA
Gl Imp 1	Output 2 mA
Ref Imp 1	Output 1 %
Raw	Output 2 %
mV Input	Measure 1
Temp 1	Blank
Man Temp 1	

Fault and Warning banner:

If the analyzer detects a problem with itself or the sensor the word Fault or Warning will appear at the bottom of the display. A fault requires immediate attention. A warning indicates a problematic condition or an impending failure. For troubleshooting assistance, press Diag.

Formatting the Main Display

The main display screen can be programmed to show primary process variables, secondary process variables and diagnostics.

1. Press MENU
2. Scroll down to **Display**. Press ENTER.
3. **Main Format** will be highlighted. Press ENTER.
4. The sensor 1 process value will be highlighted in reverse video. Press the selection keys to navigate down to the screen sections that you wish to program. Press **ENTER**.
5. Choose the desired display parameter or diagnostic for each of the four display sections in the lower screen.
6. Continue to navigate and program all desired screen sections. Press **MENU** and **EXIT**. The screen will return to the main display.

For single sensor configurations, the default display shows the live process measurement in the upper display area and temperature in the center display area. The user can elect to disable the display of temperature in the center display area using the Main Format function. See Fig. 4-1 to guide you through programming the main display to select process parameters and diagnostics of your choice.

For dual sensor configurations, the default display shows Sensor 1 live process measurement in the upper display area and Sensor 2 live process measurement temperature in the center display area. See Fig. 4-1 to guide you through programming the main display to select process parameters and diagnostics of your choice.

4.4 Menu System

Model 1056 uses a scroll and select menu system. Pressing the MENU key at any time opens the top-level menu including Calibrate, Hold, Program and Display functions.

To find a menu item, scroll with the up and down keys until the item is highlighted. Continue to scroll and select menu items until the desired function is chosen. To select the item, press ENTER. To return to a previous menu level or to enable the main live display, press the EXIT key repeatedly. To return immediately to the main display from any menu level, simply press MENU then EXIT.

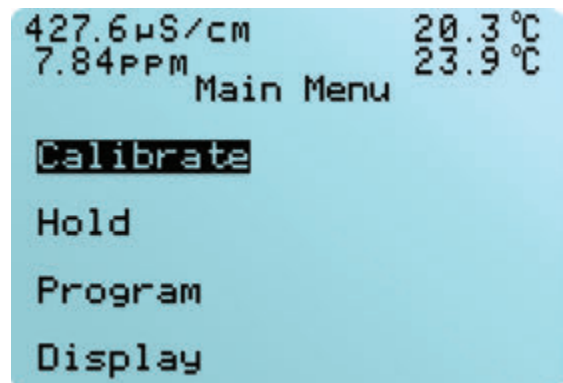

The selection keys have the following functions:

- The Up key (above ENTER) increments numerical values, moves the decimal place one place to the right, or selects units of measurement.
- The Down key (below ENTER) decrements numerical values, moves the decimal place one place to the left, or selects units of measurement
- The Left key (left of ENTER) moves the cursor to the left.
- The Right key (right of ENTER) moves the cursor to the right.

To access desired menu functions, use the “Quick Reference” Figure B. During all menu displays (except main display format and Quick Start), the live process measurements and secondary measurement values are displayed in the top two lines of the Upper display area. This conveniently allows display of the live values during important calibration and programming operations.

Menu screens will time out after two minutes and return to the main live display.

FIGURE 4-1 Formatting the Main Display

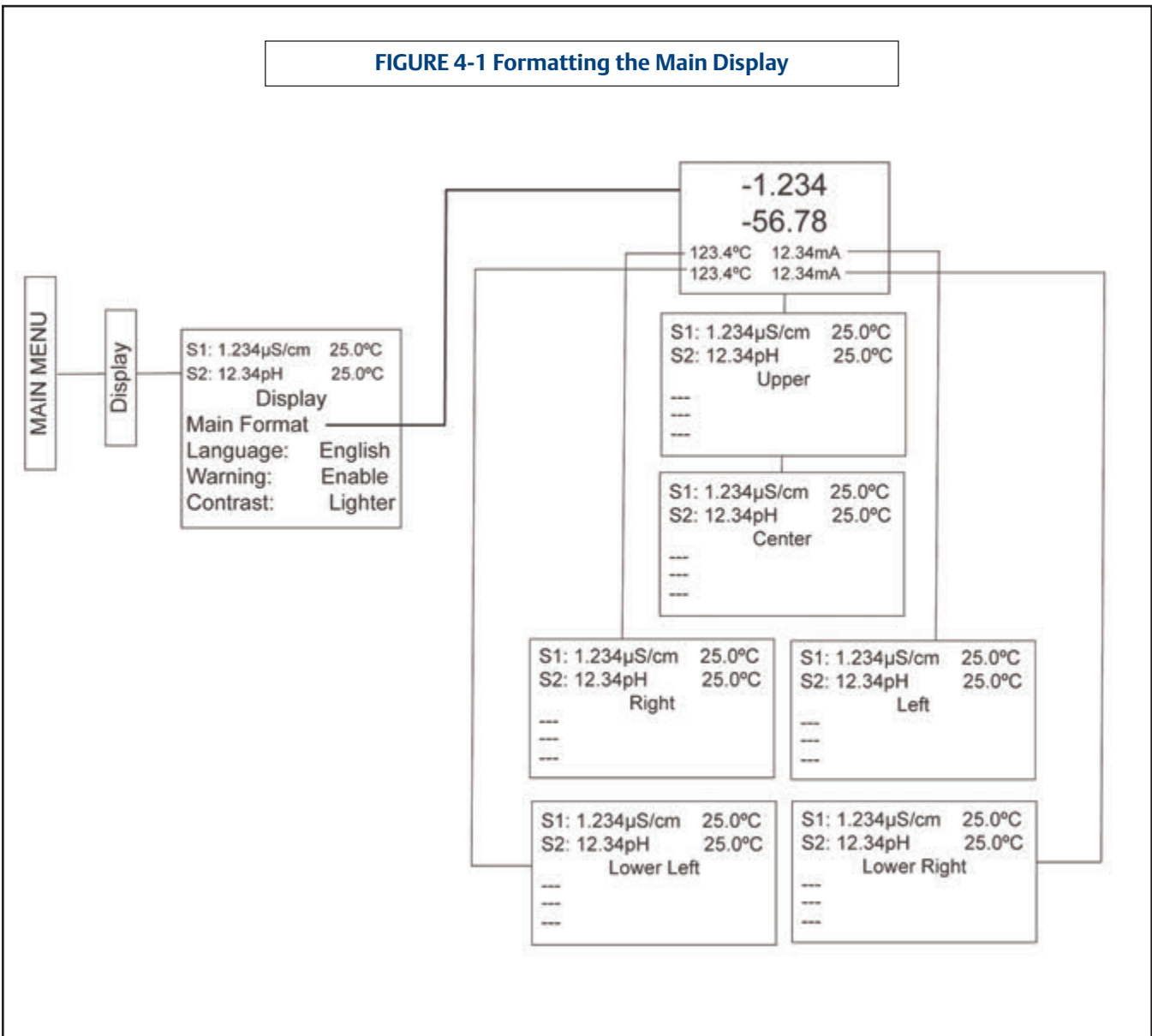

Section 5.0

Programming The Analyzer - Basics

- 5.1 General
- 5.2 Changing Start-Up Settings
- 5.3 Programming Temperature
- 5.4 Configuring and Ranging 4-20ma Outputs
- 5.5 Setting Security Codes
- 5.6 Security Access
- 5.7 Using Hold
- 5.8 Resetting Factory Defaults – Reset Analyzer
- 5.9 Programming Alarm Relays

5.1 General

Section 5.0 describes the following programming functions:

- Changing the measurement type, measurement units and temperature units.
- Choose temperature units and manual or automatic temperature compensation mode
- Configure and assign values to the current outputs
- Set a security code for two levels of security access
- Accessing menu functions using a security code
- Enabling and disabling Hold mode for current outputs
- Choosing the frequency of the AC power (needed for optimum noise rejection)
- Resetting all factory defaults, calibration data only, or current output settings only

5.2 Changing Startup Settings

5.2.1 Purpose

To change the measurement type, measurement units, or temperature units that were initially entered in Quick Start, choose the Reset analyzer function (Sec. 5.9) or access the Program menus for sensor 1 or sensor 2 (Sec. 6.0). The following choices for specific measurement type, measurement units are available for each sensor measurement board.

TABLE 5-1. Measurements and Measurement Units

Signal board	Available measurements	Measurements units:
pH/ORP (22, 32)	pH, ORP, Redox, Ammonia, Fluoride, Custom ISE	pH, mV (ORP) %, ppm, mg/L, ppb, µg/L, (ISE)
Contacting conductivity (20, 30)	Conductivity, Resistivity, TDS, Salinity, NaOH (0-12%), HCl (0-15%), Low H2SO4, High H2SO4, NaCl (0-20%), Custom Curve	µS/cm, mS/cm, S/cm % (concentration)
Toroidal conductivity (21, 31)	Conductivity, Resistivity, TDS, Salinity, NaOH (0-12%), HCl (0-15%), Low H2SO4, High H2SO4, NaCl (0-20%), Custom Curve	µS/cm, mS/cm, S/cm % (concentration)
Chlorine (24, 34)	Free Chlorine, pH Independ. Free Cl, Total Chlorine, Monochloramine	ppm, mg/L
Oxygen (25, 35)	Oxygen (ppm), Trace Oxygen (ppb), Percent Oxygen in gas, Salinity	ppm, mg/L, ppb, µg/L % Sat, Partial Pressure, % Oxygen In Gas, ppm Oxygen In Gas
Ozone (-26, -36)	Ozone	ppm, mg/L, ppb, µg/L
Temperature (all)	Temperature	°C, °F

5.2.2 Procedure

Follow the Reset Analyzer procedure (Sec 5.8) to reconfigure the analyzer to display new measurements or measurement units. To change the specific measurement or measurement units for each signal board type, refer to the Program menu for the appropriate measurement (Sec. 6.0).

5.3 Choosing Temperature Units And Automatic/Manual Temperature Compensation

5.3.1 Purpose

Most liquid analytical measurements (except ORP) require temperature compensation. The Model 1056 performs temperature compensation automatically by applying internal temperature correction algorithms. Temperature correction can also be turned off. If temperature correction is off, the Model 1056 uses the temperature entered by the user in all temperature correction calculations.

5.3.2 Procedure

Follow the menu screens in Fig. 5.1 to select automatic or manual temp compensation, set the manual reference temperature, and to program temperature units as °C or °F.

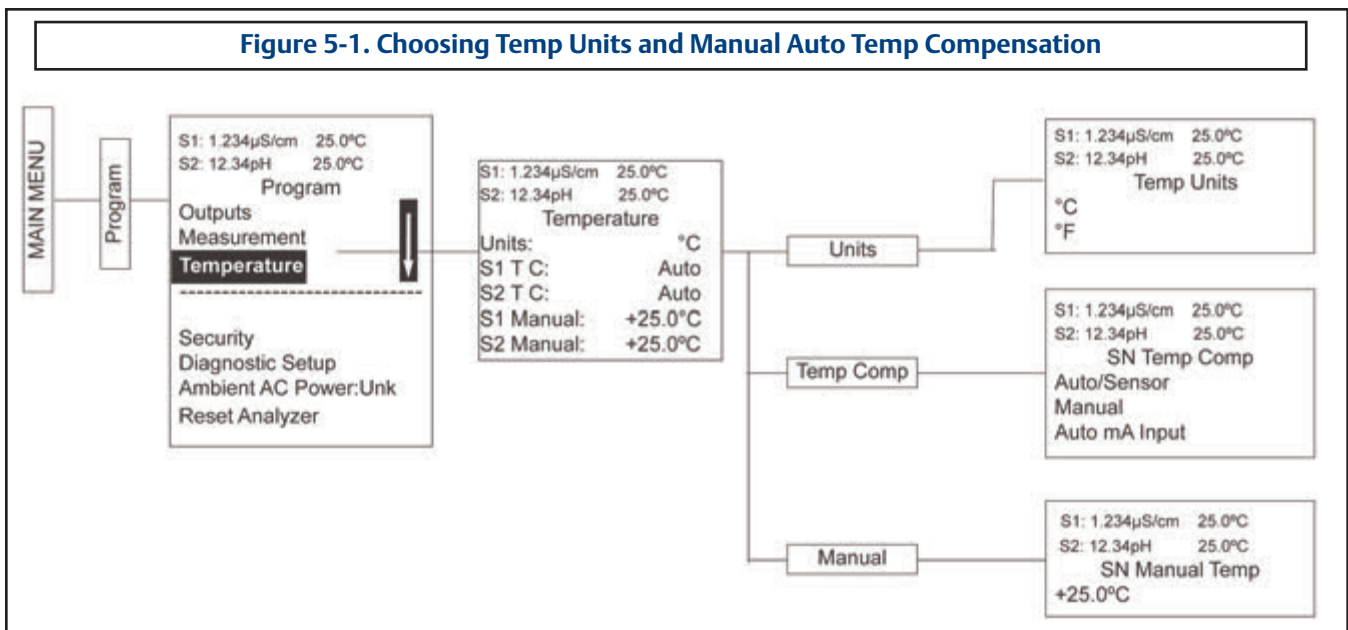
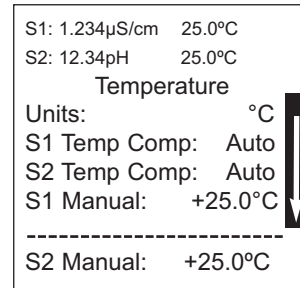

5.4 Configuring and Ranging The Current Outputs

5.4.1 Purpose

The Model 1056 accepts inputs from two sensors and has two analog current outputs. Ranging the outputs means assigning values to the low (0 or 4 mA) and high (20 mA) outputs. This section provides a guide for configuring and ranging the outputs. ALWAYS CONFIGURE THE OUTPUTS FIRST.

5.4.2 Definitions

1. CURRENT OUTPUTS. The analyzer provides a continuous output current (4-20 mA or 0-20 mA) directly proportional to the process variable or temperature.

The low and high current outputs can be set to any value.

2. ASSIGNING OUTPUTS. Assign a measurement to Output 1 or Output 2.

3. DAMPEN. Output dampening smooths out noisy readings. It also increases the response time of the output. Output dampening does not affect the response time of the display.

4. MODE. The current output can be made directly proportional to the displayed value (linear mode) or directly proportional to the common logarithm of the displayed value (log mode).

5.4.3 Procedure: Configure Outputs

Under the Program/Outputs menu, the adjacent screen will appear to allow configuration of the outputs. Follow the menu screens in Fig. 5-2 to configure the outputs.

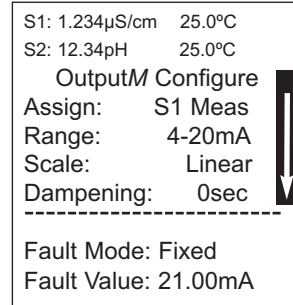

5.4.4 Procedure: Assigning Measurements the Low and High Current Outputs

The adjacent screen will appear when entering the Assign function under Program/Output/Configure. These screens allow you to assign a measurement, process value, or temperature input to each output. Follow the menu screens in Fig. 5-2 to assign measurements to the outputs.

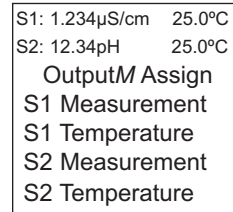

5.4.5 Procedure: Ranging the Current Outputs

The adjacent screen will appear under Program/Output/Range. Enter a value for 4mA and 20mA (or 0mA and 20mA) for each output. Follow the menu screens in Fig. 5-2 to assign values to the outputs.

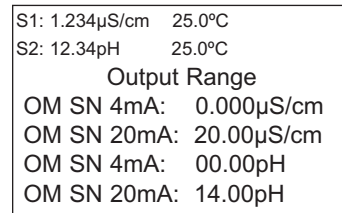
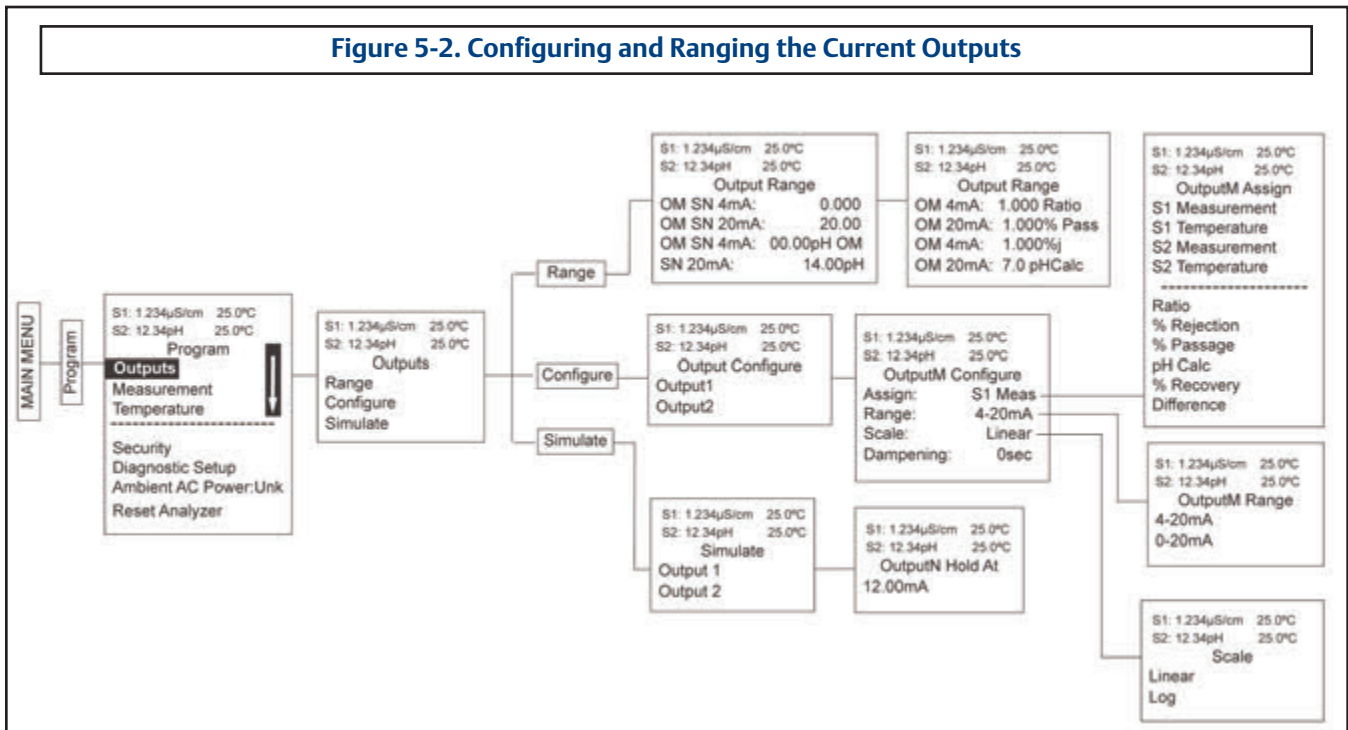

Figure 5-2. Configuring and Ranging the Current Outputs



5.5 Setting A Security Code

5.5.1 Purpose

The security codes prevent accidental or unwanted changes to program settings, displays, and calibration. Model 1056 has two levels of security code to control access and use of the instrument to different types of users. The two levels of security are:

- **All:** This is the Supervisory security level. It allows access to all menu functions, including Programming, Calibration, Hold and Display.
- **Calibration/Hold:** This is the operator or technician level menu. It allows access to only calibration and Hold of the current outputs.

5.5.2 Procedure

1. Press MENU. The main menu screen appears. Choose **Program**.

2. Scroll down to Security. Select **Security**.
3. The security entry screen appears. Enter a three digit security code for each of the desired security levels. The security code takes effect two minutes after the last key stroke. Record and communicate the security code(s) for future access to operators or technicians as needed.
4. The display returns to the security menu screen. Press EXIT to return to the previous screen. To return to the main display, press MENU followed by EXIT.

Fig. 5-3 displays the security code screens.

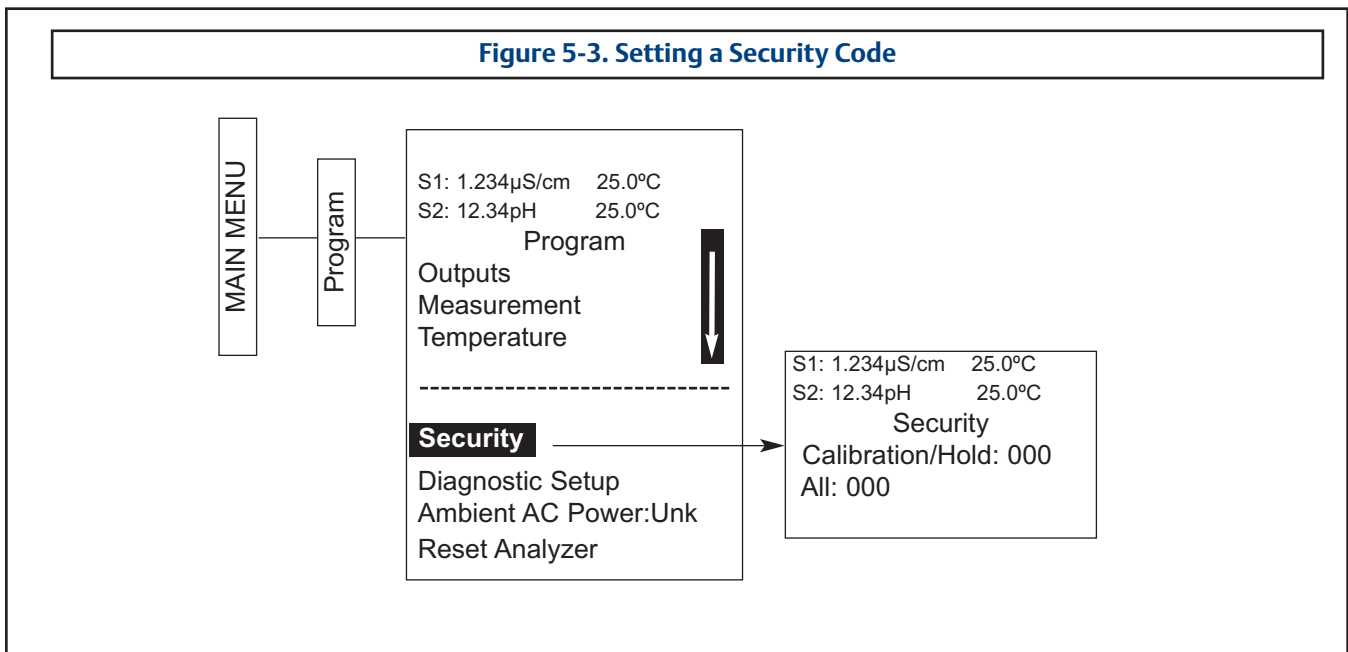

5.6 Security Access

5.6.1 How the Security Code Works

When entering the correct access code for the **Calibration/Hold** security level, the Calibration and Hold menus are accessible. This allows operators or technicians to perform routine maintenance. This security level does not allow access to the Program or Display menus.

When entering the correct access code for **All** security level, the user has access to all menu functions, including Programming, Calibration, Hold and Display.

5.6.2 Procedure

1. If a security code has been programmed, selecting the Calibrate, Hold, Program or Display top menu items causes the security access screen to appear
2. Enter the three-digit security code for the appropriate security level.

S1: 1.234µS/cm	25.0°C
S2: 12.34pH	25.0°C
Security Code	
000	

3. If the entry is correct, the appropriate menu screen appears. If the entry is incorrect, the **Invalid Code** screen appears. The **Enter Security Code** screen reappears after 2 seconds.

5.7 Using Hold

5.7.1 Purpose

The analyzer output is always proportional to measured value. To prevent improper operation of systems or pumps that are controlled directly by the current output, place the analyzer in hold before removing the sensor for calibration and maintenance. Be sure to remove the analyzer from hold once calibration is complete. During hold, both outputs remain at the last value. **Once in hold, all current outputs remain on Hold indefinitely.**

5.7.2 Using the Hold Function

To hold the outputs,

1. Press MENU. The main menu screen appears. Choose **Hold**.
2. The **Hold Outputs and Alarms?** screen appears. Choose **Yes** to place the analyzer in hold. Choose **No** to take the analyzer out of hold.
Note: There are no alarm relays with this configuration. Current outputs are included with all configurations.
3. The Hold screen will then appear and **Hold will remain on indefinitely until Hold is disabled**.

See figure 5-1 below.

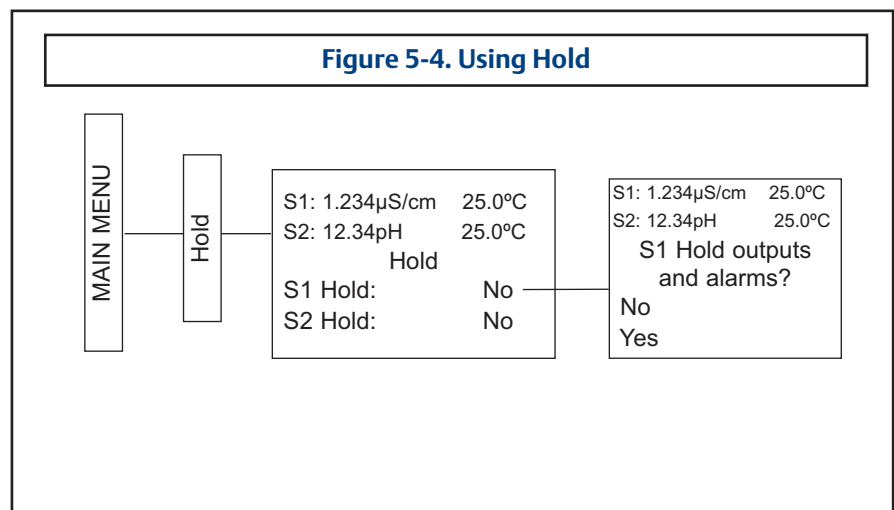

5.8 Resetting Factory Default Settings

5.8.1 Purpose

This section describes how to restore factory calibration and default values. The process also clears all fault messages and returns the display to the first Quick Start screen. The Model 1056 offers three options for resetting factory defaults.

- a. reset all settings to factory defaults
- b. reset sensor calibration data only
- c. reset analog output settings only

5.8.2. Procedure

To reset to factory defaults, reset calibration data only or reset analog outputs only, follow the Reset Analyzer flow diagram.

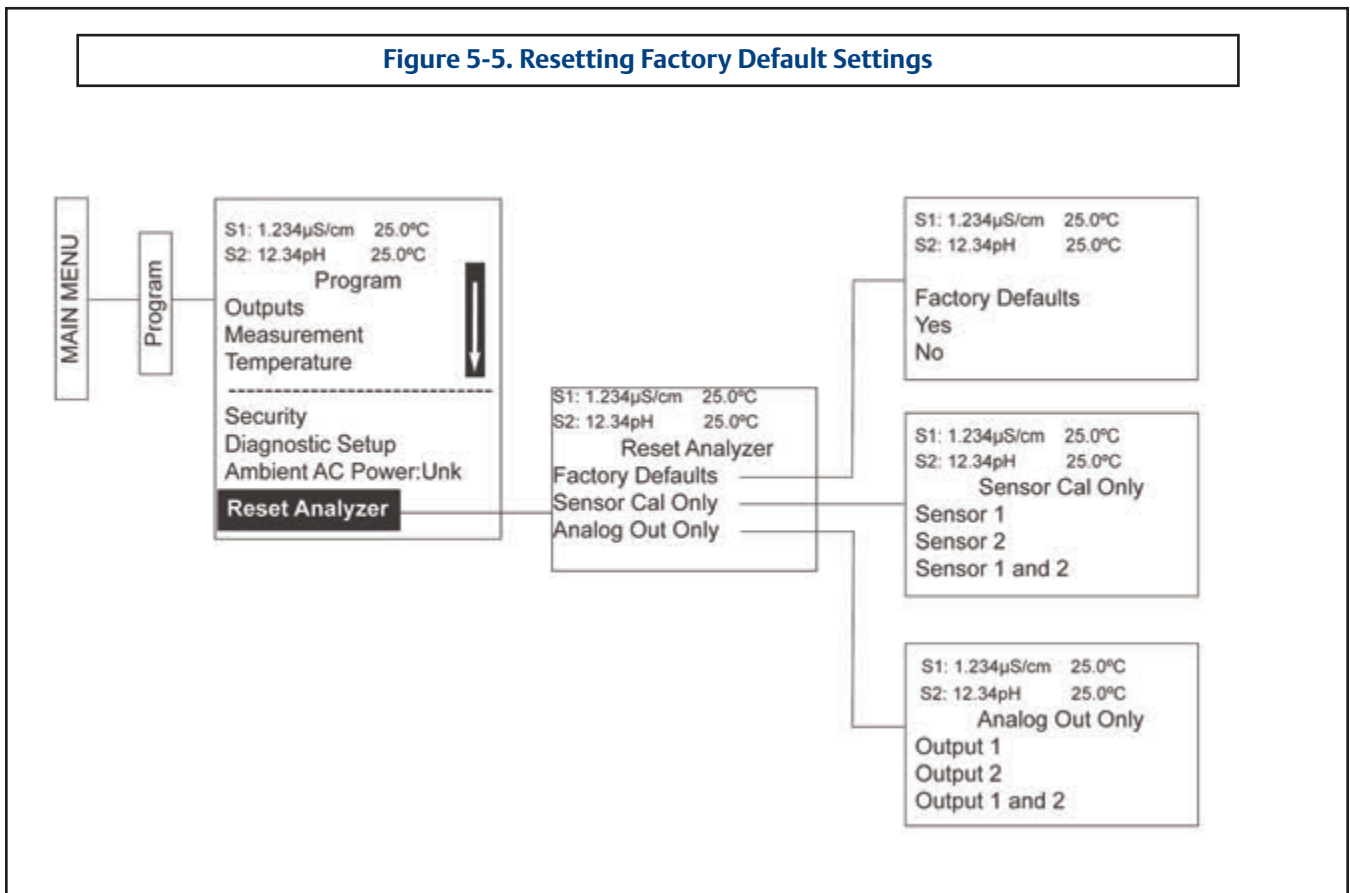

5.9 Programming Alarm Relays

5.9.1 Purpose

The Model 1056 24VDC (02 order code) and the AC switching power supply (03 order code) provide four alarm relays for process measurement or temperature. Each alarm can be configured as a fault alarm instead of a process alarm. Also, each relay can be programmed independently and each can be programmed as an interval timer. This section describes how to configure alarm relays, simulate relay activation, and synchronize timers for the four alarm relays. This section provides details to program the following alarm features:

Sec.	Alarm relay feature:	default	Description
5.9.2	Enter Setpoint	100.0uS/cm	Enter alarm trigger value
5.9.3	Assign measurement	S1 Measure	Select alarm assignment
5.9.4	Set relay logic	High	Program relay to activate at High or Low reading
5.9.5	Deadband:	0.00uS/cm	Program the change in process value after the relay deactivates
5.9.6	USP Safety:	0%↓	Program percentage of the limit to activate the alarm
5.9.7	Normal state:	Open	Program relay default condition as open or closed for failsafe operation
5.9.8	Interval time:	24.0 hr	Time in hours between relay activations
5.9.9	On-Time:	10 min	Enter the time in seconds that the relay is activated.
5.9.10	Recover time:	60 sec	Enter time after the relay deactivation for process recovery
5.9.11	Hold while active:	S1	Holds current outputs during relay activation
5.9.12	Simulate		Manually simulate alarms to confirm relay operation
5.9.13	Synchronize Timers	Yes	Control the timing of two or more relay timers set as Interval timers

Under the **Program/Alarms** menu, this screen will appear to allow configuration of the alarm relays. Follow the menu screens in Fig. XX to configure the outputs.

```
S1: 1.234µS/cm  25.0°C
S2: 12.34pH    25.0°C
                Alarms
Configure/Setpoint
Simulate
Synchronize Timers: Yes
```

This screen will appear to allow selection of a specific alarm relay. Select the desired alarm and press ENTER.

```
S1: 1.234µS/cm  25.0°C
S2: 12.34pH    25.0°C
                Configure/Setpoint
Alarm 1
Alarm 2
Alarm 3
Alarm 4
```

This screen will appear next to allow complete programming of each alarm. Factory defaults are displayed as they would appear for an installed contacting conductivity board. USP Safety only appears if alarm logic is set to "USP". Interval timer, On Time, Recover Time, and Hold While Active only appear if the alarm is configured as an Interval timer.

```
S1: 1.234µS/cm  25.0°C
S2: 12.34pH    25.0°C
                AlarmM Settings
Setpoint:      100.0uS/cm
Assign:        S1 Measure
Logic:         High
Deadband:      0.00uS/cm
USP Safety:    0%↓
-----
Interval time: 24.0 hr
On Time:       120 sec
Recover time:  60 sec
Hold while active: Sens1
```

5.9.2 Procedure – Enter Setpoints

Under the Program/Alarms menu, this screen will appear to allow configuration of the alarm relays. Enter the desired value for the process measurement or temperature at which to activate an alarm event.

```
S1: 1.234µS/cm  25.0°C
S2: 12.34pH    25.0°C
Alarm1 S2 Setpoint
+100.0uS/cm
```

5.9.3 Procedure – Assign Measurement

Under the Alarms Settings menu, this screen will appear to allow assignment of the alarm relays. select an alarm assignment. Additional assignment choices are shown in Figure X-X depending on which measurement board(s) is installed.

```
S1: 1.234µS/cm  25.0°C
S2: 12.34pH    25.0°C
AlarmM Assign:
S1 Measurement
S1 Temperature
S2 Measurement
S2 Temperature
-----
Interval Timer
Fault
Off
```

5.9.4 Procedure – Set Relay Logic

Under the **Alarms Settings** menu, this screen will appear to set the alarm logic. Select the desired relay logic to activate alarms at a High reading or a Low reading. USP Safety only appears if a contacting conductivity board is installed.

```
S1: 1.234µS/cm  25.0°C
S2: 12.34pH    25.0°C
AlarmM Logic:
High
Low
USP
```

5.9.5 Procedure – Deadband

Under the Alarms Settings menu, this screen will appear to program the deadband as a measurement value. Enter the change in the process value needed after the relay deactivates to return to normal (and thereby preventing repeated alarm activation).

```
S1: 1.234µS/cm  25.0°C
S2: 12.34pH    25.0°C
Alarm1 Deadband
+000.5uS/cm
```

5.9.6 Procedure – USP Safety

Under the Alarms Settings menu, this screen will appear to program the USP alarm setting. Enter the percentage below the limit at which to activate the alarm.

```
S1: 1.234µS/cm  25.0°C
S2: 12.34pH    25.0°C
Alarm1 USP Safety
+0%↓
```

5.9.7 Procedure – Normal State

The user can define failsafe condition in software by programming the alarm default state to normally open or normally closed upon power up. To display this alarm configuration item, enter the Expert menus by holding down the EXIT key for 6 seconds while in the main display mode. Select Yes upon seeing the screen prompt: "Enable Expert Menu?"

Under the Alarms Settings menu, this screen will appear to set the normal state of the alarms. Select the alarm condition that is desired each time the analyzer is powering up.

```
S1: 1.234µS/cm  25.0°C
S2: 12.34pH    25.0°C
Alarm2 Normal State
Open
Closed
```

5.9.8 Procedure – Interval time

Under the Alarms Settings menu, this screen will appear to set the interval time. Enter the fixed time in hours between relay activations.

S1: 1.234µS/cm 25.0°C
S2: 12.34pH 25.0°C
Alarm1 Interval Time
024.0 hrs

5.9.9 Procedure – On time

Under the Alarms Settings menu, this screen will appear to set the relay on time. Enter the time in seconds that the relay is activated.

S1: 1.234µS/cm 25.0°C
S2: 12.34pH 25.0°C
Alarm1 On-Time
00.00sec

5.9.10 Procedure – Recovery time

Under the Alarms Settings menu, this screen will appear to set the relay recovery time. Enter time after the relay deactivation for process recovery.

S1: 1.234µS/cm 25.0°C
S2: 12.34pH 25.0°C
Alarm1 Recovery
060sec

5.9.11 Procedure – Hold while active

Under the Alarms Settings menu, this screen will appear to program the feature that Holds the current outputs while alarms are active. Select to hold the current outputs for Sensor 1, Sensor 2 or both sensors while the relay is activated.

S1: 1.234µS/cm 25.0°C
S2: 12.34pH 25.0°C
Alarm1 Hold while active
Sensor 1
Sensor 2
Both
None

5.9.12 Procedure – Simulate

Alarm relays can be manually set for the purposes of checking devices such as valves or pumps. Under the Alarms Settings menu, this screen will appear to allow manual forced activation of the alarm relays. Select the desired alarm condition to simulate.

S1: 1.234µS/cm 25.0°C
S2: 12.34pH 25.0°C
Simulate Alarm M
Don't simulate
De-energize
Energize

5.9.13 Procedure – Synchronize

Under the Alarms Settings menu, this screen will appear to allow Synchronization of alarms that are set to interval timers. Select yes or no to Synchronize two or more timers.

S1: 1.234µS/cm 25.0°C
S2: 12.34pH 25.0°C
Synchronize Timers
Yes
No

Section 6.0

Programming - Measurements

6.1 Configuring Measurements – Introduction

6.2 pH

6.3 ORP

6.4 Contacting Conductivity

6.5 Toroidal Conductivity

6.6 Chlorine

6.6.1 Free Chlorine

6.6.2 Total Chlorine

6.6.3 Monochloramine

6.6.4 pH-Independent Free Chlorine

6.7 Oxygen

6.8 Ozone

6.9 Turbidity

6.10 Flow

6.11 Current Input

6.1 Programming Measurements – Introduction

The Model 1056 automatically recognizes each installed measurement board upon first power-up and each time the analyzer is powered. Completion of Quick Start screens upon first power up enable measurements, but additional steps may be required to program the analyzer for the desired measurement application. This section covers the following programming and configuration functions;

1. Selecting measurement type or sensor type (all sections)
2. Identifying the preamp location (pH-see Sec. 6.2)
3. Enabling manual temperature correction and entering a reference temperature (all sections)
4. Enabling sample temperature correction and entering temperature correction slope (selected sections)
5. Defining measurement display resolution (pH and amperometric)
6. Defining measurement display units (all sections)
7. Adjusting the input filter to control display and output reading variability or noise (all sections)
8. Selecting a measurement range (conductivity – see Sec's 6.4, 6.5)
9. Entering a cell constant for a contacting or toroidal sensor (see Sec's 6.4, 6.5)
10. Entering a temperature element/RTD offset or temperature slope (conductivity-see Sec's 6.4)
11. Creating an application-specific concentration curve (conductivity-see Sec's 6.4, 6.5)
12. Enabling automatic pH correction for free chlorine measurement (Sec. 6.6.1)

To fully configure the analyzer for each installed measurement board, you may use the following:

1. Reset Analyzer function to reset factory defaults and configure the measurement board to the desired measurement. Follow the Reset Analyzer menu (Fig. 5-5) to reconfigure the analyzer to display new measurements or measurement units.
2. Program menus to adjust any of the programmable configuration items. Use the following configuration and programming guidelines for the applicable measurement.

6.2 pH Measurement Programming

6.2.1 Description

This section describes how to configure the Model 1056 analyzer for pH measurements. The following programming and configuration functions are covered.

TABLE 6-1. pH Measurement Programming

Measure	Sec.	Menu function:	default setting	Description
pH	6.2.2	Measurement type:	pH	Select pH, ORP, Redox, Ammonia, Fluoride, Custom ISE
	6.2.3	Preamp location:	Analyzer	Identify preamp location
	6.2.4	Solution temperature correction	Off	Select Off, ultra-pure, high pH, custom
	6.2.5	Temp coefficient	(custom)	Enter the temp coefficient
	6.2.6	Resolution:	0.01pH	Select 0.01pH or 0.1pH for pH display resolution
	6.2.7	Filter:	4 sec	Override the default input filter, enter 0-999 seconds
	6.2.8	Reference Z:	Low	Select low or high reference impedance

A detailed flow diagram for pH programming is provided at the end of Sec. 6 to guide you through all basic programming and configuration functions.

To configure the pH measurement board:

1. Press **MENU**
2. Scroll down to **Program**. Press ENTER.
3. Scroll down to Measurement. Press ENTER.
4. Select **Sensor 1** or **Sensor 2** corresponding to pH. Press ENTER.

The adjacent screen format will appear (factory defaults are shown). To program any function, scroll to the desired item and press ENTER.

S1: 1.234μS/cm	25.0°C
S2: 12.34pH	25.0°C
SN Configure	
Measure:	pH
Preamp:	Analyzer
Sol'n Temp Corr:	Off
T Coeff:	-0.029pH/°C

Resolution:	0.01pH
Filter:	4 sec
Reference Z:	Low

The following sub-sections provide you with the initial display screen that appears for each configuration function. Use the **flow diagram for pH programming** at the end of Sec. 6 and the Model 1056 live screen prompts for each function to complete configuration and programming.

6.2.2 Measurement

The display screen for selecting the measurement is shown. The default value is displayed in **bold type**. Refer to the pH/ORP Programming flow diagram to complete this function.

S1: 1.234μS/cm	25.0°C
S2: 12.34pH	25.0°C
SN Measurement	
pH	
ORP	
Redox	
Ammonia	

Fluoride	
Custom ISE	

6.2.3 Preamp

The display screen for identifying the Preamp location is shown. The default value is displayed in **bold type**. Refer to the pH/ORP Programming flow diagram to complete this function.

S1: 1.234μS/cm	25.0°C
S2: 12.34pH	25.0°C
SN Preamp	
Analyzer	
Sensor/JBox	

6.2.4 Solution Temperature Correction

The display screen for selecting the Solution temperature correction algorithm is shown. The default value is displayed in **bold type**. Refer to the pH/ORP Programming flow diagram to complete this function.

```
S1: 1.234µS/cm  25.0°C
S2: 12.34pH    25.0°C
      SN Sol'n Temp Corr.
Off
Ultra Pure Water
High pH
Custom
```

6.2.5 Temperature Coefficient

The display screen for entering the custom solution temperature coefficient is shown. The default value is displayed in **bold type**. Refer to the pH/ORP Programming flow diagram to complete this function.

```
S1: 1.234µS/cm  25.0°C
S2: 12.34pH    25.0°C
      SN Sol'n Temp Coeff.
- 0.032pH/°C
```

6.2.6 Resolution

The display screen for selecting 0.01pH or 0.1pH for pH display resolution is shown. The default value is displayed in **bold type**. Refer to the pH/ORP Programming flow diagram to complete this function.

```
S1: 1.234µS/cm  25.0°C
S2: 12.34pH    25.0°C
      SN Resolution
0.01pH
0.1pH
```

6.2.7 Filter

The display screen for entering the input filter value in seconds is shown. The default value is displayed in **bold type**. Refer to the pH/ORP Programming flow diagram to complete this function.

```
S1: 1.234µS/cm  25.0°C
S2: 12.34pH    25.0°C
      SN Input filter
04 sec
```

6.2.8 Reference Impedance

The display screen for selecting Low or High Reference impedance is shown. The default value is displayed in **bold type**. Refer to the pH/ORP Programming flow diagram to complete this function.

```
S1: 1.234µS/cm  25.0°C
S2: 12.34pH    25.0°C
      SN Reference Z
Low
High
```

6.3 ORP Measurement Programming

6.3.1 Description

The section describes how to configure the Model 1056 analyzer for ORP measurements. The following programming and configuration functions are covered:

TABLE 6-2. ORP Measurement Programming

Measure	Sec.	Menu function:	default	Description
ORP	6.3.2	Measurement type:	pH	Select pH, ORP, Redox, Ammonia, Fluoride, Custom ISE
	6.3.3	Preamp location:	Analyzer	Identify preamp location
	6.3.4	Filter:	4 sec	Override the default input filter, enter 0-999 seconds
	6.3.5	Reference Z:	Low	Select low or high reference impedance

A detailed flow diagram for ORP programming is provided at the end of Sec. 6 to guide you through all basic programming and configuration functions.

To configure the ORP measurement board:

1. Press **MENU**
2. Scroll down to **Program**. Press ENTER.
3. Scroll down to **Measurement**. Press ENTER.
4. Select **Sensor 1** or **Sensor 2** corresponding to ORP. Press ENTER.

The adjacent screen format will appear (factory defaults are shown). To program any displayed function, scroll to the desired item and press ENTER.

S1: 1.234µS/cm	25.0°C
S2: 12.34pH	25.0°C
SN Configure	
Measure:	pH
Preamp:	Analyzer
Filter:	4 sec
Reference Z:	Low

The following sub-sections provide you with the initial display screen that appears for each configuration function. Use the **flow diagram for ORP programming** at the end of Sec. 6 and the Model 1056 live screen prompts for each function to complete configuration and programming.

6.3.2 Measurement

The display screen for selecting the measurement is shown. The default value is displayed in **bold type**. Refer to the pH/ORP Programming flow diagram to complete this function.

S1: 1.234µS/cm	25.0°C
S2: 12.34pH	25.0°C
SN Measurement	
pH	
ORP	
Redox	
Ammonia	
Fluoride	
Custom ISE	

6.3.3 Preamp

The display screen for identifying the Preamp location is shown. The default value is displayed in **bold type**. Refer to the pH/ORP Programming flow diagram to complete this function.

S1: 1.234µS/cm	25.0°C
S2: 12.34pH	25.0°C
SN Preamp	
Analyzer	
Sensor/JBox	

6.3.4 Filter

The display screen for entering the input filter value in seconds is shown. The default value is displayed in **bold type**. Refer to the pH/ORP Programming flow diagram to complete this function.

S1: 1.234µS/cm	25.0°C
S2: 12.34pH	25.0°C
SN Input filter	
04 sec	

6.3.5 Reference Impedence

The display screen for Selecting Low or high Reference impedance is shown. The default value is displayed in **bold type**. Refer to the pH/ORP Programming flow diagram to complete this function.

S1: 1.234µS/cm	25.0°C
S2: 12.34pH	25.0°C
SN Reference Z	
Low	
High	

6.4 Contacting Conductivity Measurement Programming

6.4.1 Description

The section describes how to configure the Model 1056 analyzer for conductivity measurements using contacting conductivity sensors. The following programming and configuration functions are covered.

TABLE 6-3. Contacting Conductivity Measurement Programming

Measure	Sec.	Menu function:	default	Description
Contacting Conductivity	6.4.2	Type:	2-Electrode	Select 2-Electrode or 4-Electrode type sensors
	6.4.3	Measure:	Conductivity	Select Conductivity, Resistivity, TDS, Salinity or % conc
	6.4.4	Range:	Auto	Select measurement Auto-range or specific range
	6.4.5	Cell K:	1.00000/cm	Enter the cell Constant for the sensor
	6.4.6	RTD Offset:	0.00°C	Enter the RTD Offset
	6.4.7	RTD Slope:	0	Enter the RTD Slope
	6.4.8	Temp Comp:	Slope	Select Temp Comp: Slope, Neutral Salt, Cation or Raw
	6.4.9	Slope:	2.00%/°C	Enter the linear temperature coefficient
	6.4.10	Ref Temp:	25.0°C	Enter the Reference temp
	6.4.11	Filter:	2 sec	Override the default input filter, enter 0-999 seconds
	6.4.12	Custom	Setup	Enter 2-5 data points in ppm and μS/cm for custom curves
	6.4.13	Cal Factor:	0.95000/cm	Enter the Cal Factor for 4-Electrode sensors from the sensor tag

A detailed flow diagram for contacting conductivity programming is provided at the end of Sec. 6 to guide you through all basic programming and configuration functions.

To configure the contacting conductivity measurement board:

1. Press **MENU**
2. Scroll down to **Program**. Press ENTER.
3. Scroll down to **Measurement**. Press ENTER.
4. Select **Sensor 1** or **Sensor 2** corresponding to contacting conductivity. Press ENTER.

The adjacent screen format will appear (factory defaults are shown). To program any displayed function, scroll to the desired item and press ENTER.

S1: 1.234μS/cm	25.0°C
S2: 12.34pH	25.0°C
SN Configure	
Type:	2-Electrode
Measure:	Cond
Range:	Auto
Cell K:	1.00000/cm
RTD Offset:	0.00°C
RTD Slope:	0
Temp Comp:	Slope
Slope:	2.00%/°C
Ref Temp:	25.0°C
Filter:	2 sec
Custom Setup	

The following sub-sections provide you with the initial display screen that appears for each configuration function. Use the **flow diagram for contacting conductivity programming** at the end of Sec. 6 and the Model 1056 live screen prompts for each function to complete configuration and programming.

6.4.2 Sensor Type

The display screen for selecting 2-Electrode or 4-Electrode type sensors is shown. The default value is displayed in **bold type**. Refer to the contacting conductivity Programming flow diagram to complete this function.

S1: 1.234μS/cm	25.0°C
S2: 12.34pH	25.0°C
SN Type	
2-Electrode	
4-Electrode	

6.4.3 Measure

The display screen for selecting the measurement is shown. The default value is displayed in **bold type**. Refer to the contacting conductivity Programming flow diagram to complete this function.

```
S1: 1.234µS/cm  25.0°C
S2: 12.34pH    25.0°C
  SN Measurement
Conductivity
Resistivity
TDS
Salinity
-----
NaOH (0-12%)
HCl (0-15%)
Low H2SO4
High H2SO4
NaCl (0-20%)
Custom Curve
```

6.4.4 Range

The display screen for Selecting Auto-ranging or a specific range is shown. The default value is displayed in **bold type**. Note: Ranges are shown as conductance, not conductivity. Refer to the contacting conductivity Programming flow diagram to complete this function.

```
S1: 1.234µS/cm  25.0°C
S2: 12.34pH    25.0°C
  SN Range
Auto
50 µS
500 µS
2000 µS
-----
20 mS
200 mS
600 mS
```

6.4.5 Cell Constant

The display screen for entering a cell Constant for the sensor is shown. The default value is displayed in **bold type**. Refer to the contacting conductivity Programming flow diagram to complete this function.

```
S1: 1.234µS/cm  25.0°C
S2: 12.34pH    25.0°C
  SN Cell Constant
1.00000 /cm
```

6.4.6 RTD Offset

The display screen for Entering the RTD Offset for the sensor is shown. The default value is displayed in **bold type**. Refer to the contacting conductivity Programming flow diagram to complete this function.

```
S1: 1.234µS/cm  25.0°C
S2: 12.34pH    25.0°C
  SN RTD Offset
0.00°C
```

6.4.7 RTD Slope

The display screen for entering the RTD slope for the sensor is shown. The default value is displayed in **bold type**. Refer to the contacting conductivity Programming flow diagram to complete this function.

```
S1: 1.234µS/cm  25.0°C
S2: 12.34pH    25.0°C
  SN RTD Slope
2.00%/°C
```

6.4.8 Temp Comp

The display screen for Selecting Temperature Compensation as Slope, Neutral Salt, Cation or Raw is shown. The default value is displayed in **bold type**. Refer to the contacting conductivity Programming flow diagram to complete this function.

```
S1: 1.234µS/cm  25.0°C
S2: 12.34pH    25.0°C
  SN Temp Comp
Slope
Neutral Salt
Cation
Raw
```

6.4.9 Slope

The display screen for Entering the conductivity/temp Slope is shown. The default value is displayed in **bold type**. Refer to the contacting conductivity Programming flow diagram to complete this function.

S1: 1.234µS/cm 25.0°C
 S2: 12.34pH 25.0°C
 SN Slope
2.00 %/°C

6.4.10 Reference Temp

The display screen for manually entering the Reference temperature is shown. The default value is displayed in **bold type**. Refer to the contacting conductivity Programming flow diagram to complete this function.

S1: 1.234µS/cm 25.0°C
 S2: 12.34pH 25.0°C
 SN Ref Temp
 (25.0°C normal)
+25.0°C

6.4.11 Filter

The display screen for entering the input filter value in seconds is shown. The default value is displayed in **bold type**. Refer to the contacting conductivity Programming flow diagram to complete this function.

S1: 1.234µS/cm 25.0°C
 S2: 12.34pH 25.0°C
 SN Input filter
02 sec

6.4.12 Custom Setup

The display screens for creating a custom curve for converting conductivity to concentration is shown. Refer to the contacting conductivity Programming flow diagram to complete this function.

S1: 1.234µS/cm 25.0°C
 S2: 12.34pH 25.0°C
 SN Custom Curve
 Configure
 Enter Data Points
 Calculate Curve

When the custom curve data entry is complete, press ENTER. The display will confirm the determination of a custom curve fit to the entered data by displaying this screen:

S1: 1.234µS/cm 25.0°C
 S2: 12.34pH 25.0°C
 SN Calculate Curve
 Custom curve
 fit completed.
 In Process Cal
 recommended.

If the custom curve fit is not completed or is unsuccessful, the display will read as follows and the screen will return to the beginning custom curve screen.

S1: 1.234µS/cm 25.0°C
 S2: 12.34pH 25.0°C
 SN Calculate Curve
 Failure

6.4.13 Cal Factor

Upon initial installation and power up, if **4-electrode** was selected for the sensor type in the **Quick Start** menus, the user enters a Cell Constant and a “Cal Factor” using the instrument keypad. The cell constant is needed to convert measured conductance to conductivity as displayed on the analyzer screen. The “Cal Factor” entry is needed increase the accuracy of the live conductivity readings, especially at low conductivity readings below 20uS/cm. Both the Cell Constant and the “Cal Factor” are printed on the tag attached to the 4-electrode sensor/cable.

The display screen for entering Cal Factor is shown. The default value is displayed in **bold type**. If necessary after initial installation and start-up, enter the “Cal Factor” as printed on the sensor tag.

S1: 1.234µS/cm 25.0°C
 S2: 12.34pH 25.0°C
 SN Cal Factor
0.95000/cm

6.5 Toroidal Conductivity Measurement Programming

6.5.1 Description

The section describes how to configure the Model 1056 analyzer for conductivity measurements using inductive/toroidal sensors. The following programming and configuration functions are covered.

TABLE 6-4. Toroidal Conductivity Measurement Programming

Measure	Sec.	Menu function:	default	Description
Toroidal conductivity	6.5.2	Model:	228	Select sensor type
	6.5.3	Measure:	Conductivity	Select Conductivity, Resistivity, TDS, Salinity or % conc
	6.5.4	Range:	Auto	Select measurement Auto-range or specific range
	6.5.5	Cell K:	3.00000/cm	Enter the cell Constant for the sensor
	6.5.6	Temp Comp:	Slope	Select Temp Comp: Slope, Neutral Salt, or Raw
	6.5.7	Slope:	2.00%/°C	Enter the linear temperature coefficient
	6.5.8	Ref Temp:	25.0°C	Enter the Reference temp
	6.5.9	Filter:	2 sec	Override the default input filter, enter 0-999 seconds
	6.5.10	Custom	Setup	Enter 2-5 data points in ppm and µS/cm for custom curves

A detailed flow diagram for toroidal conductivity programming is provided at the end of Sec. 6 to guide you through all basic programming and configuration functions.

To configure the toroidal conductivity measurement board:

1. Press **MENU**
2. Scroll down to **Program**. Press ENTER.
3. Scroll down to **Measurement**. Press ENTER.
4. Select **Sensor 1** or **Sensor 2** corresponding to toroidal conductivity. Press ENTER.

The adjacent screen format will appear (factory defaults are shown). To program any displayed function, scroll to the desired item and press ENTER.

S1: 1.234µS/cm	25.0°C
S2: 12.34pH	25.0°C
SN Configure	
Model:	228
Measure:	Cond
Range:	Auto

Cell K:	3.00000/cm
RTD Offset:	0.00°C
RTD Slope:	0
Temp Comp:	Slope
Slope:	2.00%/°C
Ref Temp:	25.0°C
Filter:	2 sec
Custom Setup	

The following sub-sections provide you with the initial display screen that appears for each configuration function. Use the **flow diagram for toroidal conductivity programming** at the end of Sec. 6 and the Model 1056 live screen prompts for each function to complete configuration and programming.

6.5.2 Sensor Model

The display screen for selecting the sensor model is shown. The default value is displayed in **bold type**. Refer to the toroidal conductivity Programming flow diagram to complete this function.

S1: 1.234µS/cm	25.0°C
S2: 12.34pH	25.0°C
SN Model	
228	
225	
226	
247	

Other	

6.5.3 Measure

The display screen for selecting the measurement is shown. The default value is displayed in **bold type**. Refer to the toroidal conductivity Programming flow diagram to complete this function.

S1: 1.234μS/cm	25.0°C
S2: 12.34pH	25.0°C
SN Measurement	
Conductivity	
Resistivity	
TDS	
Salinity	

NaOH (0-12%)	
HCl (0-15%)	
Low H2SO4	
High H2SO4	
NaCl (0-20%)	
Custom Curve	

6.5.4 Range

The display screen for Selecting Auto-ranging or a specific range is shown. The default value is displayed in bold type. Note: Ranges are shown as conductance, not conductivity. Refer to the toroidal conductivity Programming flow diagram to complete this function.

S1: 1.234μS/cm	25.0°C
S2: 12.34pH	25.0°C
SN Range	
Auto	
2000 mS	
50 mS	
2 mS	

200μS	

6.5.5 Cell Constant

The display screen for entering a cell Constant for the sensor is shown. The default value is displayed in **bold type**. Refer to the toroidal conductivity Programming flow diagram to complete this function.

S1: 1.234μS/cm	25.0°C
S2: 12.34pH	25.0°C
SN Cell Constant	
3.00000 /cm	

6.5.6 Temp Comp

The display screen for Selecting Temperature Compensation as Slope, Neutral Salt, or Raw is shown. The default value is displayed in **bold type**. Refer to the toroidal conductivity Programming flow diagram to complete this function.

S1: 1.234μS/cm	25.0°C
S2: 12.34pH	25.0°C
SN Temp Comp	
Slope	
Neutral Salt	
Raw	

6.5.7 Slope

The display screen for Entering the conductivity/temp Slope is shown. The default value is displayed in **bold type**. Refer to the toroidal conductivity Programming flow diagram to complete this function.

```
S1: 1.234µS/cm  25.0°C
S2: 12.34pH    25.0°C
      SN Slope
2.00%/°C
```

6.5.8 Ref Temp

The display screen for manually Entering the Reference temperature is shown. The default value is displayed in **bold type**. Refer to the toroidal conductivity Programming flow diagram to complete this function.

```
S1: 1.234µS/cm  25.0°C
S2: 12.34pH    25.0°C
      SN Ref Temp
      (25.0°C normal)
+25.0°C
```

6.5.9 Filter

The display screen for entering the input filter value in seconds is shown. The default value is displayed in **bold type**. Refer to the toroidal conductivity Programming flow diagram to complete this function.

```
S1: 1.234µS/cm  25.0°C
S2: 12.34pH    25.0°C
      SN Input filter
02 sec
```

6.5.10 Custom Setup

The display screens for creating custom curves for converting conductivity to concentration is shown. Refer to the toroidal conductivity Programming flow diagram to complete this function.

```
S1: 1.234µS/cm  25.0°C
S2: 12.34pH    25.0°C
      SN Custom Curve
      Configure
      Enter Data Points
      Calculate Curve
```

When the custom curve data entry is complete, press ENTER. The display will confirm the determination of a custom curve fit to the entered data by displaying this screen:

```
S1: 1.234µS/cm  25.0°C
S2: 12.34pH    25.0°C
      SN Calculate Curve
      Custom curve
      fit completed.
      In Process Cal
      recommended.
```

If the custom curve fit is not completed or is unsuccessful, the display will read as follows and the screen will return to the beginning custom curve screen.

```
S1: 1.234µS/cm  25.0°C
S2: 12.34pH    25.0°C
      SN Calculate Curve
      Failure
```

6.6 Chlorine Measurement Programming

With a Chlorine measurement board installed, Model 1056 can measure any of four variants of Chlorine:

- Free Chlorine
- Total Chlorine
- Monochloramine
- pH-independent Free Chlorine

The section describes how to configure the Model 1056 analyzer for Chlorine measurements.

6.6.1 Free Chlorine Measurement Programming

6.6.1.1 Description

This Chlorine sub-section describes how to configure the Model 1056 analyzer for Free Chlorine measurement using amperometric chlorine sensors. The following programming and configuration functions are covered:

TABLE 6-5. Free Chlorine Measurement Programming

Measure	Sec.	Menu function:	default	Description
Free Chlorine	6.6.1.2	Measure:	Free Chlorine	Select Free Chlorine, pH Ind. Free Cl. Total Cl, Monochloramine
	6.6.1.3	Units:	ppm	Select units ppm or mg/L
	6.6.1.4	Filter:	5sec	Override the default input filter, enter 0-999 seconds
	6.6.1.5	Free Cl Correct:	Live	Select Live/Continuous pH correction or Manual
	6.6.1.6	Manual pH:	7.00 pH	For Manual pH correction, enter the pH value
	6.6.1.7	Resolution:	0.001	Select display resolution 0.01 or 0.001

A detailed flow diagram for programming of all chlorine measurements is provided at the end of Sec. 6 to guide you through all basic programming and configuration functions.

To configure the chlorine measurement board for free chlorine:

1. Press **MENU**
2. Scroll down to **Program**. Press ENTER.
3. Scroll down to **Measurement**. Press ENTER.
4. Select **Sensor 1** or **Sensor 2** corresponding to chlorine. Press ENTER.

The adjacent screen format will appear (factory defaults are shown). To program any displayed function, scroll to the desired item and press ENTER.

S1: 1.234µS/cm	25.0°C
S2: 12.34pH	25.0°C
SN Configure	
Measure:	Free Chlorine
Units:	ppm

Filter:	5sec
Free Cl Correct:	Live
Manual pH:	7.00 pH
Resolution:	0.001

The following sub-sections provide you with the initial display screen that appears for each configuration function. Use the **flow diagram for chlorine programming** at the end of Sec. 6 and the Model 1056 live screen prompts for each function to complete configuration and programming.

6.6.1.2 Measure

The display screen for selecting the measurement is shown. The default value is displayed in **bold type**. Refer to the Chlorine Programming flow diagram to complete this function.

S1: 1.234 μ S/cm	25.0°C
S2: 12.34pH	25.0°C
SN Measurement	
Free Chlorine	
pH Independ. Free Cl	
Total Chlorine	
Monochloramine	

6.6.1.3 Units

The display screen for selecting units as ppm or mg/L is shown. The default value is displayed in **bold type**. Refer to the Chlorine Programming flow diagram to complete this function.

S1: 1.234 μ S/cm	25.0°C
S2: 12.34pH	25.0°C
SN Units	
ppm	
mg/L	

6.6.1.4 Filter

The display screen for entering the input filter value in seconds is shown. The default value is displayed in **bold type**. Refer to the Chlorine Programming flow diagram to complete this function.

S1: 1.234 μ S/cm	25.0°C
S2: 12.34pH	25.0°C
SN Input filter	
05 sec	

6.6.1.5 Free Chlorine pH Correction

The display screen for Selecting Live/Continuous pH correction or Manual pH correction is shown. The default value is displayed in **bold type**. Refer to the Chlorine Programming flow diagram to complete this function.

S1: 1.234 μ S/cm	25.0°C
S2: 12.34pH	25.0°C
SN Free Cl	
pH Correction	
Live/Continuous	
Manual	

6.6.1.6 Manual pH Correction

The display screen for manually entering the pH value of the measured process liquid is shown. The default value is displayed in **bold type**. Refer to the Chlorine Programming flow diagram to complete this function.

S1: 1.234 μ S/cm	25.0°C
S2: 12.34pH	25.0°C
SN Manual pH	
07.00 pH	

6.6.1.7 Resolution

The display screen for selecting display resolution as 0.001 or 0.01 is shown. The default value is displayed in **bold type**. Refer to the Chlorine Programming flow diagram to complete this function.

S1: 1.234 μ S/cm	25.0°C
S2: 12.34pH	25.0°C
SN Resolution -	
0.001	
0.01	

6.6.2 Total Chlorine Measurement Programming

6.6.2.1 Description

This Chlorine sub-section describes how to configure the Model 1056 analyzer for Total Chlorine measurement using amperometric chlorine sensors. The following programming and configuration functions are covered:

TABLE 6-6. Total Chlorine Measurement Programming

Measure	Sec.	Menu function:	default	Description
Total Chlorine	6.6.2.2	Measure:	Free Chlorine	Select Free Chlorine, pH Ind. Free Cl. Total Cl, Monochloramine
	6.6.2.3	Units:	ppm	Select units ppm or mg/L
	6.6.2.4	Filter:	5sec	Override the default input filter, enter 0-999 seconds
	6.6.2.5	Resolution:	0.001	Select 0.01 or 0.001 display resolution

A detailed flow diagram for programming of all chlorine measurements is provided at the end of Sec. 6 to guide you through all basic programming and configuration functions.

To configure the chlorine measurement board for total chlorine:

1. Press **MENU**
2. Scroll down to **Program**. Press ENTER.
3. Scroll down to **Measurement**. Press ENTER.
4. Select **Sensor 1** or **Sensor 2** corresponding to chlorine. Press ENTER.

```
S1: 1.234µS/cm  25.0°C
S2: 12.34pH    25.0°C
          SN Configure
Measure: Free Chlorine
Units:      ppm
Filter:     5sec
Resolution: 0.001
```

The adjacent screen format will appear (factory defaults are shown). To program any displayed function, scroll to the desired item and press ENTER.

The following sub-sections provide you with the initial display screen that appears for each configuration function. Use the flow diagram for chlorine programming at the end of Sec. 6 and the Model 1056 live screen prompts for each function to complete configuration and programming.

6.6.2.2 Measure

The display screen for selecting the measurement is shown. The default value is displayed in **bold type**. Refer to the chlorine Programming flow diagram to complete this function.

```
S1: 1.234µS/cm  25.0°C
S2: 12.34pH    25.0°C
          SN Measurement
Free Chlorine
pH Independ. Free Cl
Total Chlorine
Monochloramine
```

6.6.2.3 Units

The display screen for selecting units as ppm or mg/L is shown. The default value is displayed in **bold type**. Refer to the Chlorine Programming flow diagram to complete this function

```
S1: 1.234µS/cm  25.0°C
S2: 12.34pH    25.0°C
          SN Units
ppm
mg/L
```

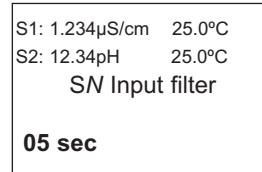

6.6.2.4 Filter

The display screen for entering the input filter value in seconds is shown. The default value is displayed in **bold type**. Refer to the Chlorine Programming flow diagram to complete this function.

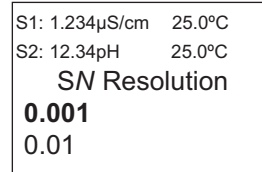

6.6.2.5 Resolution

The display screen for selecting display resolution as 0.001 or 0.01 is shown. The default value is displayed in **bold type**. Refer to the Chlorine Programming flow diagram to complete this function.



6.6.3 Monochloramine Measurement Programming

6.6.3.1 Description

This Chlorine sub-section describes how to configure the Model 1056 analyzer for Monochloramine measurement using amperometric chlorine sensors. The following programming and configuration functions are covered:

TABLE 6-7. Monochloramine Measurement Programming

Measure	Sec.	Menu function: default	Description
Monochloramine	6.6.3.2	Measure: Free Chlorine	Select Free Chlorine, pH Ind. Free Cl. Total Cl, Monochloramine
	6.6.3.3	Units: ppm	Select units ppm or mg/L
	6.6.3.4	Filter: 5sec	Override the default input filter, enter 0-999 seconds
	6.6.3.5	Resolution: 0.001	Select 0.01pH or 0.1ppm/mg/L for display Resolution

A detailed flow diagram for programming of all chlorine measurements is provided at the end of Sec. 6 to guide you through all basic programming and configuration functions.

To configure the chlorine measurement board for monochloramine:

1. Press **MENU**
2. Scroll down to **Program**. Press ENTER.
3. Scroll down to **Measurement**. Press ENTER.
4. Select **Sensor 1** or **Sensor 2** corresponding to chlorine. Press ENTER.

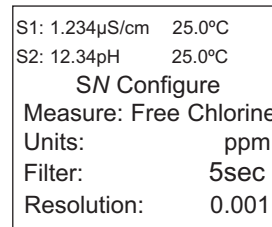

The following screen format will appear (factory defaults are shown). To program any displayed function, scroll to the desired item and press ENTER.

The following sub-sections provide you with the initial display screen that appears for each configuration function. Use the **flow diagram for chlorine programming** at the end of Sec. 6 and the Model 1056 live screen prompts for each function to complete configuration and programming.

6.6.3.2-Measure: Monochloramine

The display screen for selecting the measurement is shown. The default value is displayed in **bold type**. Refer to the Chlorine Programming flow diagram to complete this function.

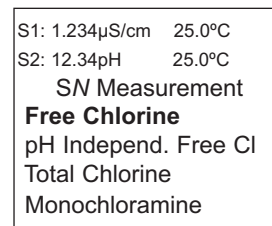

6.6.3.3 Units

The display screen for selecting units as ppm or mg/L is shown. The default value is displayed in **bold type**. Refer to the Chlorine Programming flow diagram to complete this function.

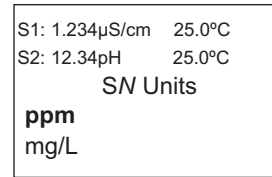

6.6.3.4 Filter

The display screen for entering the input filter value in seconds is shown. The default value is displayed in **bold type**. Refer to the Chlorine Programming flow diagram to complete this function.

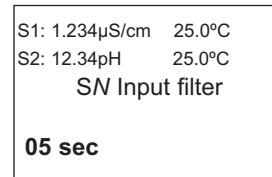

6.6.3.5 Resolution

The display screen for selecting display resolution as 0.001 or 0.01 is shown. The default value is displayed in **bold type**. Refer to the Chlorine Programming flow diagram to complete this function.

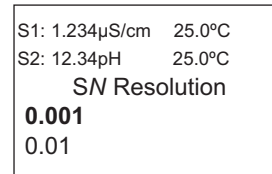

6.6.4 pH-Independent Free Chlorine Measurement Programming

6.6.4.1 Description

This Chlorine sub-section describes how to configure the Model 1056 analyzer for Free Chlorine measurements using the pH-independent free chlorine sensor, Model 498CL-01, manufactured by Rosemount. The following programming and configuration functions are covered:

TABLE 6-8. pH-independent Free Chlorine Measurement Programming

Measure	Sec.	Menu function: default	Description
pH-independent Free Chlorine	6.6.4.2	Measure: pH Indep Free Cl	Select Free Chlorine, pH Ind. Free Cl. Total Cl, Monochloramine
	6.6.4.3	Units: ppm	Select units ppm or mg/L
	6.6.4.4	Filter: 5sec	Override the default input filter, enter 0-999 seconds
	6.6.4.5	Resolution: 0.001	Select 0.01pH or 0.1ppm/mg/L for display Resolution

A detailed flow diagram for programming of all chlorine measurements is provided at the end of Sec. 6 to guide you through all basic programming and configuration functions.

To configure the chlorine measurement board for pH-independent free chlorine:

1. Press **MENU**
2. Scroll down to **Program**. Press ENTER.
3. Scroll down to **Measurement**. Press ENTER.
4. Select **Sensor 1** or **Sensor 2** corresponding to chlorine. Press ENTER.

The adjacent screen format will appear (factory defaults are shown). To program any displayed function, scroll to the desired item and press ENTER.

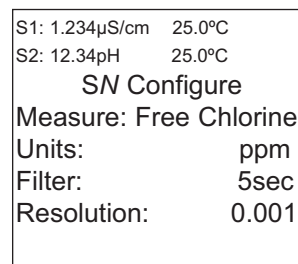

The following sub-sections provide you with the initial display screen that appears for each configuration function. Use the **flow diagram for chlorine programming** at the end of Sec. 6 and the Model 1056 live screen prompts for each function to complete configuration and programming.

6.6.4.2 Measurement: pH-independent Free Chlorine

The display screen for selecting the measurement is shown. The default value is displayed in **bold type**. Refer to the chlorine Programming flow diagram to complete this function.

```
S1: 1.234µS/cm  25.0°C  
S2: 12.34pH    25.0°C  
      SN Measurement  
Free Chlorine  
pH Independ. Free Cl  
Total Chlorine  
Monochloramine
```

6.6.4.3 Units

The display screen for selecting units as ppm or mg/L is shown. The default value is displayed in **bold type**. Refer to the Chlorine Programming flow diagram to complete this function.

```
S1: 1.234µS/cm  25.0°C  
S2: 12.34pH    25.0°C  
      SN Units  
ppm  
mg/L
```

6.6.4.4 Filter

The display screen for entering the input filter value in seconds is shown. The default value is displayed in **bold type**. Refer to the Chlorine Programming flow diagram to complete this function.

```
S1: 1.234µS/cm  25.0°C  
S2: 12.34pH    25.0°C  
      SN Input filter  
05 sec
```

6.6.4.5 Resolution

The display screen for selecting display resolution as 0.001 or 0.01 is shown. The default value is displayed in **bold type**. Refer to the Chlorine Programming flow diagram to complete this function.

```
S1: 1.234µS/cm  25.0°C  
S2: 12.34pH    25.0°C  
      SN Resolution  
0.001  
0.01
```

6.7 Oxygen Measurement Programming

6.7.1 Description

This section describes how to configure the Model 1056 analyzer for dissolved and gaseous oxygen measurement using amperometric oxygen sensors. The following programming and configuration functions are covered:

TABLE 6-9. Oxygen Measurement Programming

Measure	Sec.	Menu function: default	Description
Oxygen	6.7.2	Type: Water/Waste	Select Water/Waste, Trace, BioRx, BioRx-Other, Brew, %O2 In Gas
	6.7.3	Units: ppm	Select ppm, mg/L, ppb, µg/L, % Sat, %O2-Gas, ppm Oxygen-Gas
	6.7.4	Partial Press: mmHg	Select mm Hg, in Hg, atm, kPa, mbar or bar for Partial pressure
	6.7.5	Salinity: 00.0‰	Enter Salinity as ‰
	6.7.6	Filter: 5sec	Override the default input filter, enter 0-999 seconds
	6.7.7	Pressure Units: bar	Select pressure units: mm Hg, in Hg, . Atm, kPa, mbar, bar
	6.7.8	Use Press: At Air Cal	Select atmospheric pressure source – internal or mA Input

A detailed flow diagram for oxygen programming is provided at the end of Sec. 6 to guide you through all basic programming and configuration functions.

To configure the Oxygen measurement board:

1. Press MENU
2. Scroll down to Program. Press ENTER.
3. Scroll down to Measurement. Press ENTER.
4. Select Sensor 1 or Sensor 2 corresponding to Oxygen. Press ENTER.

The adjacent screen format will appear (factory defaults are shown). To program any displayed function, scroll to the desired item and press ENTER.

```
S1: 1.234µS/cm 25.0°C
S2: 12.34pH 25.0°C
SN Configure
Type: Water/Waste
Units: ppm
Partial Press: mmHg
-----
Salinity: 00.0‰
Filter: 5sec
Pressure Units: bar
Use Press: At Air Cal
Custom Setup
```

The following sub-sections show the initial display screen that appears for each configuration function. Use the **flow diagram for oxygen programming** at the end of Sec. 6 and the Model 1056 live screen prompts for each function to complete configuration and programming.

6.7.2 Oxygen Measurement application

The display screen for programming the measurement is shown. The default value is displayed in **bold type**. Refer to the Oxygen Programming flow diagram to complete this function.

```
S1: 1.234µS/cm 25.0°C
S2: 12.34pH 25.0°C
SN Type
Water/Waste
Trace Oxygen
BioRx-Rosemount
BioRx-Other
-----
Brewing
Oxygen In Gas
```

6.7.3 Units

The display screen for selecting units as ppm, mg/L, ppb, µg/L, % Saturation, %Oxygen in Gas, or ppm Oxygen in Gas is shown. The default value is displayed in **bold type**. Refer to the Oxygen Programming flow diagram to complete this function.

```
S1: 1.234µS/cm 25.0°C
S2: 12.34pH 25.0°C
SN Units
ppm
mg/L
ppb
µg/L
-----
% Saturation
Partial Pressure
% Oxygen In Gas
ppm Oxygen In Gas
```

6.7.4 Partial Press

The display screen for selecting pressure units for Partial pressure is shown. This selection is needed if the specified measurement is Partial pressure. The default value is displayed in **bold type**. Refer to the Oxygen Programming flow diagram to complete this function.

```
S1: 1.234µS/cm  25.0°C
S2: 12.34pH    25.0°C
  SN Partial Press
mm Hg
in Hg
atm
kPa
-----
mbar
bar
```

6.7.5 Salinity

The display screen for Entering the Salinity (as parts per thousand) of the process liquid to be measured is shown. The default value is displayed in **bold type**. Refer to the Oxygen Programming flow diagram to complete this function.
Enter Salinity as ‰

```
S1: 1.234µS/cm  25.0°C
S2: 12.34pH    25.0°C
  SN Salinity
00.0 ‰
```

6.7.6 Filter

The display screen for entering the input filter value in seconds is shown. The default value is displayed in **bold type**. Refer to the Oxygen Programming flow diagram to complete this function.

```
S1: 1.234µS/cm  25.0°C
S2: 12.34pH    25.0°C
  SN Input filter
05 sec
```

6.7.7 Pressure Units

The display screen for selecting pressure units for atmospheric pressure is shown. This selection is needed for the display of atmospheric pressure measured by the onboard pressure transducer on the Oxygen measurement board. The default value is displayed in **bold type**. Refer to the Oxygen Programming flow diagram to complete this function.

```
S1: 1.234µS/cm  25.0°C
S2: 12.34pH    25.0°C
  Pressure Units
mm Hg
in Hg
atm
kPa
-----
mbar
bar
```

6.7.8 Use Pressure

The display screen for selecting atmospheric pressure source. The default value is displayed in **bold type**. Refer to the Oxygen Programming flow diagram to complete this function.

```
S1: 1.234µS/cm  25.0°C
S2: 12.34pH    25.0°C
  SN Use Pressure?
At Air Cal
mA Input
```

6.8 Ozone Measurement Programming

6.8.1 Description

This section describes how to configure the 1056 analyzer for ozone measurement using amperometric ozone sensors. The following programming and configuration functions are covered:

TABLE 6-10. Ozone Measurement Programming

Measure	Sec.	Menu function:	default	Description
Ozone	6.8.2	Units:	ppm	Select units ppm, mg/L, ppb, µg/L
	6.8.3	Filter:	5sec	Override the default input filter, enter 0-999 seconds
	6.8.4	Resolution:	0.001	Select 0.01or 0.001 for display resolution

A detailed flow diagram for ozone programming is provided at the end of Sec. 6 to guide you through all basic programming and configuration functions.

To configure the Ozone measurement board:

1. Press **MENU**
2. Scroll down to **Program**. Press ENTER.
3. Scroll down to **Measurement**. Press ENTER.
4. Select **Sensor 1** or **Sensor 2** corresponding to Ozone. Press ENTER.

```
S1: 1.234µS/cm  25.0°C
S2: 12.34pH    25.0°C
SN Configure
Units:         ppm
Filter:        5 sec
Resolution:    0.001
```

The adjacent screen format will appear (factory defaults are shown). To program any displayed function, scroll to the desired item and press ENTER.

The following sub-sections show the initial display screen that appears for each configuration function. Use the **flow diagram for ozone programming** at the end of Sec. 6 and the Model 1056 live screen prompts for each function to complete configuration and programming.

Note: Ozone measurement boards are detected automatically by the analyzer. No measurement selection is necessary.

6.8.2 Units

The display screen for selecting measurement units is shown. The default value is displayed in **bold type**. Refer to the Ozone Programming flow diagram to complete this function.

```
S1: 1.234µS/cm  25.0°C
S2: 12.34pH    25.0°C
SN Units
ppm
mg/L
ppb
µg/L
```

6.8.3 Filter

The display screen for entering the input filter value in seconds is shown. The default value is displayed in **bold type**. Refer to the Ozone Programming flow diagram to complete this function.

```
S1: 1.234µS/cm  25.0°C
S2: 12.34pH    25.0°C
SN Input filter
05 sec
```

6.8.4 Resolution

The display screen for selecting display resolution as 0.001 or 0.01 is shown. The default value is displayed in **bold type**. Refer to the Ozone Programming flow diagram to complete this function.

```
S1: 1.234µS/cm  25.0°C
S2: 12.34pH    25.0°C
SN Resolution
0.001
0.01
```

6.9 Turbidity Measurement Programming

6.9.1 Description

This section describes how to configure the Model 1056 analyzer for Turbidity measurements. The following programming and configuration functions are covered.

TABLE 6-11 Turbidity Measurement Programming

Measure	Sec.	Menu function:	default	Description
Turbidity	6.9.2	Measurement type:	Turbidity	Select Turbidity or TSS calculation (estimated TSS)
	6.9.3	Measurement units:	NTU	NTU, FTU, FNU
	6.9.4	Enter TSS* Data:		Enter TSS and NTU data to calculate TSS based on Turbidity
	6.9.5	Filter:	20 sec	Override the default input filter, enter 0-999 seconds
	6.9.6	Bubble Rejection:	On	Intelligent software algorithm to eliminate erroneous readings caused by bubble accumulation in the sample

*TSS: Total Suspended Solids

A detailed flow diagram for Turbidity programming is provided at the end of Sec. 6 to guide you through all basic programming and configuration functions.

To configure the Turbidity measurement board:

1. Press MENU
2. Scroll down to Program. Press ENTER.
3. Scroll down to Measurement. Press ENTER.
4. Select Sensor 1 or Sensor 2 corresponding to Turbidity. Press ENTER.

```

S1: 1.234µS/cm  25.0°C
S2: 12.34pH    25.0°C
      SN Configure
Measure:  Turbidity
Units:    NTU
Enter TSS Data
Filter:    20sec
-----
Bubble Rejection: On
    
```

The following screen format will appear (factory defaults are shown).

To program Turbidity, scroll to the desired item and press ENTER.

The following sub-sections provide you with the initial display screen that appears for each programming routine. Use the flow diagram for Turbidity programming at the end of Sec. 6 and the live screen prompts to complete programming.

6.9.2 Measurement

The display screen for selecting the measurement is shown. The default measurement is displayed in bold type. Refer to the Turbidity Programming flow diagram to complete this function.

```

S1: 1.234µS/cm  25.0°C
S2: 12.34pH    25.0°C
      SN Measurement
Turbidity
Calculated TSS
    
```

6.9.3 Units

The display screen for selecting the measurement units is shown. The default value is displayed in bold type. Refer to the Turbidity Programming flow diagram to complete this function.

```

S1: 1.234µS/cm  25.0°C
S2: 12.34pH    25.0°C
      SN Units
NTU
FTU
FNU
    
```

If TSS data (Total Suspended Solids) calculation is selected, the following screen will be displayed. Refer to the Turbidity programming flow diagram to complete this function.

```
S1: 1.234µS/cm  25.0°C
S2: 12.34pH     25.0°C
                SN Units
                ppm
                mg/L
                none
```

6.9.4 Enter TSS Data

The display screen for entering TSS Data is shown. The default values are displayed. Refer to the Turbidity Programming flow diagram to complete this function

```
S1: 1.234µS/cm  25.0°C
S2: 12.34pH     25.0°C
                SN TSS Data
Pt1 TSS: 0.000ppm
Pt1 Turbid: 0.000NTU
Pt2 TSS: 100.0ppm
Pt2 Turbid: 100.0NTU
-----
                Calculate
```

Note: Based on user-entered NTU data, calculating TSS as a straight line curve could cause TSS to go below zero. The following screen lets users know that TSS will become zero below a certain NTU value.

```
S1: 1.234µS/cm  25.0°C
S2: 12.34pH     25.0°C
                SN TSS Data
Calculation Complete
Calculated TSS = 0 below
xxxx NTU
```

The following illustration shows the potential for calculated TSS to go below zero

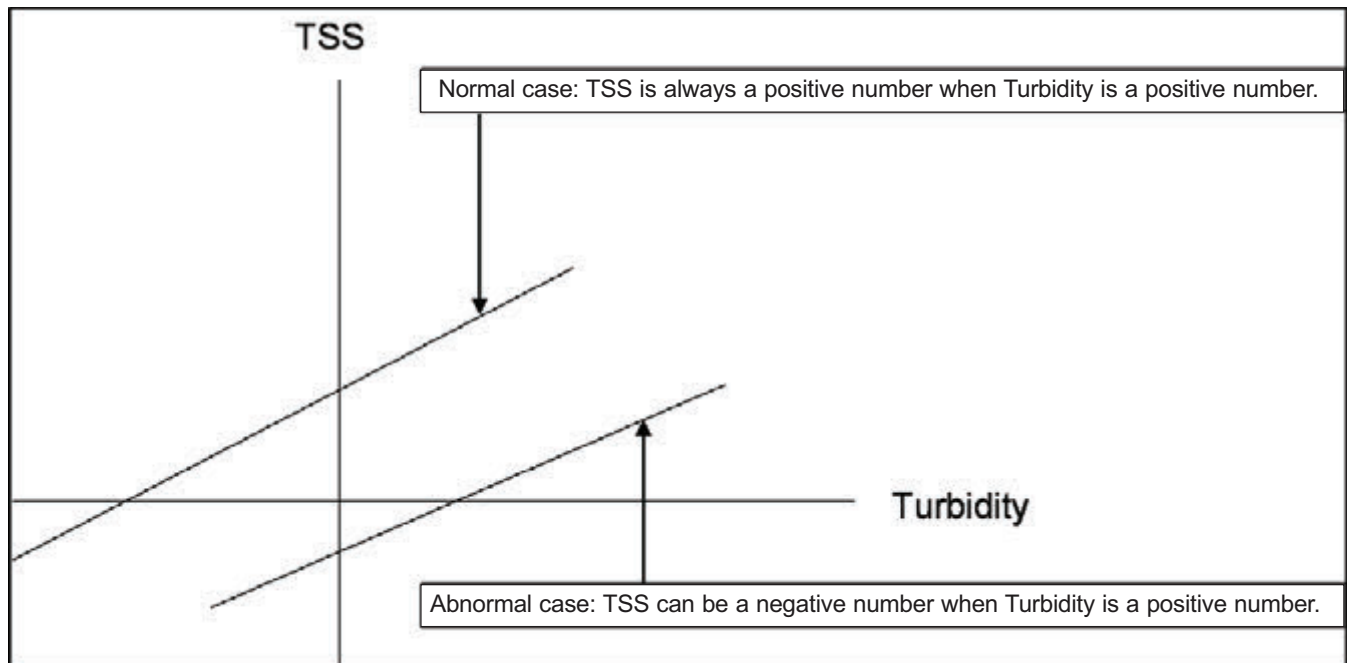

When the TSS data entry is complete, press ENTER. The display will confirm the determination of a TSS straight line curve fit to the entered NTU/turbidity data by displaying this screen:

```
S1: 1.234µS/cm  25.0°C  
S2: 12.34pH    25.0°C  
      SN TSS Data  
      Calculation  
      Complete
```

The following screen may appear if TSS calculation is unsuccessful. Re-entry of NTU and TSS data is required.

```
S1: 1.234µS/cm  25.0°C  
S2: 12.34pH    25.0°C  
      SN TSS Data  
      Data Entry Error  
  
Press EXIT
```

6.9.5 Filter

The display screen for entering the input filter value in seconds is shown. The default value is displayed in bold type. Refer to the Turbidity Programming flow diagram to complete this function.

```
S1: 1.234µS/cm  25.0°C  
S2: 12.34pH    25.0°C  
      SN Input Filter  
      020sec
```

6.9.6 Bubble Rejection

Bubble rejection is an internal software algorithm that characterizes turbidity readings as bubbles as opposed to true turbidity of the sample. With Bubble rejection enabled, these erroneous readings are eliminated from the live measurements shown on the display and transmitted via the current outputs.

```
S1: 1.234µS/cm  25.0°C  
S2: 12.34pH    25.0°C  
      SN Bubble Rejection  
      On  
      Off
```

The display screen for selecting bubble rejection algorithm is shown. The default setting is displayed in bold type. Refer to the Turbidity Programming flow diagram to complete this function.

6.10 Flow Measurement Programming

6.10.1 Description

This section describes how to configure the 1056 analyzer for flow measurement when used with a compatible pulse flow sensor. The following programming and configuration functions are covered.

TABLE 6-12 Flow Measurement Programming

Measure	Sec.	Menu function:	default	Description
Flow	6.10.2	Measurement type	Pulse Flow	Select Pulse Flow or mA Current Input
	6.10.3	Measurement units:	GPH	Select GPM, GPH, cu ft/min, cu ft/hour, LPM, L/hour, m3/hr
	6.10.4	Enter TSS* Data:	0 Sec	Override the default input filter, enter 0-999 seconds

To configure the flow measurement board:

1. Press **MENU**
2. Scroll down to **Program**. Press ENTER.
3. Scroll down to **Measurement**. Press ENTER.
4. Select **Sensor 1** or **Sensor 2** corresponding to flow. Press ENTER.

```
S1: 1.234µS/cm  25.0°C
S2: 12.34pH    25.0°C
SN Configure
Measure: Pulse Flow
Units:      GPM
Filter:     5sec
```

The following screen format will appear (factory defaults are shown).

To program pulse flow, scroll to the desired item and press ENTER.

The following sub-sections provide you with the initial display screen that appears for each programming routine. Use the diagram for pulse flow programming at the end of Sec. 6 and the live screen prompts to complete programming.

6.10.2 Measurement

The display screen for selecting the measurement is shown. The default measurement is displayed in bold type. Refer to the pulse flow Programming diagram to complete this function.

```
S1: 1.234µS/cm  25.0°C
S2: 12.34pH    25.0°C
SN Measurement
Pulse Flow
mA Input
```

6.10.3 Units

The display screen for selecting measurement units is shown. The default units are displayed in bold type. Refer to the pulse flow Programming diagram to complete this function.

```
S1: 1.234µS/cm  25.0°C
S2: 12.34pH    25.0°C
SN Units
GPM
GPH
cu ft/min
cu ft/hour
-----
L/min
L/hour
m3/hour
```

6.10.4 Filter

The display screen for entering the input filter value in seconds is shown. The default value is displayed in bold type. Refer to the pulse flow Programming diagram to complete this function.

```
S1: 1.234µS/cm  25.0°C
S2: 12.34pH    25.0°C
SN Input Filter
005sec
```

6.11 Current Input Programming

6.11.1 Description

This section describes how to configure the Model 1056 analyzer for current input measurement when wired to an external device that transmits 4-20mA or 0-20mA analog current output. The following programming and configuration functions are covered.

TABLE 6-13 Current Input Programming

Measure	Sec.	Menu function:	default	Description
Current Input	6.11.2	Measurement type	mA input	Override the default (Flow) and select mA current input
	6.11.3	mA Input	Temperature	Select Temperature, Pressure, Flow or Other
	6.11.4	Measurement units:	°C	Select measurement units based on selected input device type
	6.11.5	Input Range:	4-20mA	Select 4-20mA or 0-20mA
	6.11.6	Low Value:	0.000°C	Enter the low measurement value to assign to 4mA
	6.11.7	High Value:	100.0°C	Enter the high measurement value to assign to 20mA
	6.11.8	Filter:	05 sec	Override the default input filter, enter 0-999 seconds

A detailed flow diagram for current input programming is provided at the end of Sec. 6 to guide you through all basic programming and configuration functions.

To configure the current input measurement board:

1. Press **MENU**
2. Scroll down to **Program**. Press ENTER.
3. Scroll down to **Measurement**. Press ENTER.
4. Select **Sensor 1** or **Sensor 2** corresponding to current input. Press ENTER.

Note that factory default is Pulse Flow not mA Input. The user must override the factory default and select mA Input to enable the current input functionality. Upon selecting mA Input, the following menu screen will appear to allow complete programming of mA Current Input.

S1: 1.234µS/cm	25.0°C
S2: 12.34pH	25.0°C
SN Configure	
Measure:	mA Input
mA Input:	Temperature
Units:	°C
Input Range:	4-20mA

Low Value:	0.001%
High Value :	100.0%
Filter:	5sec

To program current input, scroll to the desired item and press ENTER.

The following sub-sections provide you with the initial display screen that appears for each programming routine. Use the flow diagram for current input programming at the end of Sec. 6 and the live screen prompts to complete programming.

6.11.2 Measurement

The display screen for selecting the signal board functionality is shown. The default value is displayed in bold type. Scroll down to select mA Input to enable the current input functionality. Refer to the current input Programming flow diagram to complete this function.

S1: 1.234µS/cm	25.0°C
S2: 12.34pH	25.0°C
SN Measurement	
Pulse Flow	
mA Input	

6.11.3 mA Input

The display screen for selecting the type of measurement is shown. The default measurement type for mA Input is displayed in bold type. Refer to the current input Programming flow diagram to complete this function.

S1: 1.234µS/cm	25.0°C
S2: 12.34pH	25.0°C
SN mA Input	
Temperature	
Pressure	
Flow	
Other	

6.11.4 Units

The display screen for selecting measurement units is shown. The default value for temperature is displayed in bold type. Refer to the current input Programming flow diagram to complete this function.

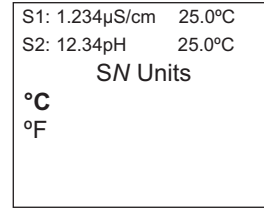

If **Pressure is selected** as the measurement type for mA Input, the following display screen is shown:

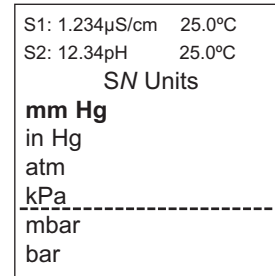

The current input board can also be used to accept a 4-20mA current input from a pulse flow sensor. If **Flow is selected** as the measurement type for the 4-20mA current input board, the following display screen is shown:

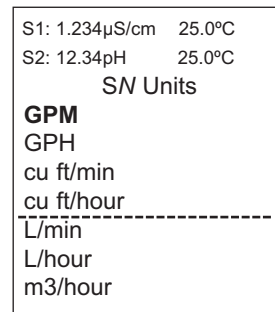

Current input can serve as a universal measurement board. 4-20mA current input can be accepted from any device and assigned to represent a wide range of measurements. If **Other is selected** as the measurement type for the 4-20mA current input board, the following display screen is shown:

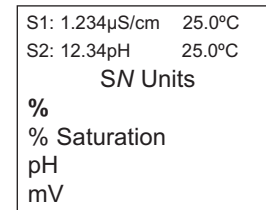

Any of the following units can also be selected to represent the 4-20mA current input. Simply scroll down to identify and select the desired measurement units as listed in the table below.

µS/cm	ppm	µg/L	NTU	ft/sec
mS/cm	ppb	mg/L	FTU	m/sec
MΩ-cm		g/L	FNU	
kΩ-cm		‰		none

6.11.5 Input Range

The display screen for selecting the Input Range is shown. The default value for mA Input is displayed in bold type. Refer to the current input Programming flow diagram to complete this function.

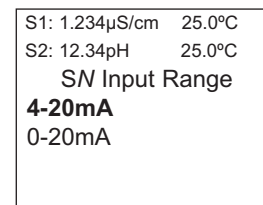

6.11.6 Low Value

The display screen for entering the Low Value to be assigned to 4mA (or 0mA) current input is shown. The default value for temperature is displayed in **bold type**. Refer to the current input Programming flow diagram to complete this function.

```
S1: 1.234µS/cm  25.0°C  
S2: 12.34pH    25.0°C  
SN Low Value  
0.000°C
```

6.11.7 High Value

The display screen for entering the High Value to be assigned to 20mA current input is shown. The default value for temperature is displayed in **bold type**. Refer to the current input Programming flow diagram to complete this function.

```
S1: 1.234µS/cm  25.0°C  
S2: 12.34pH    25.0°C  
SN High Value  
100.0°C
```

6.11.8 Filter

The display screen for entering the input filter value in seconds is shown. The default value is displayed in **bold type**. Refer to the current input Programming diagram to complete this function. .

```
S1: 1.234µS/cm  25.0°C  
S2: 12.34pH    25.0°C  
SN Input Filter  
005sec
```

FIGURE 6-2 Configure Contacting Measurements

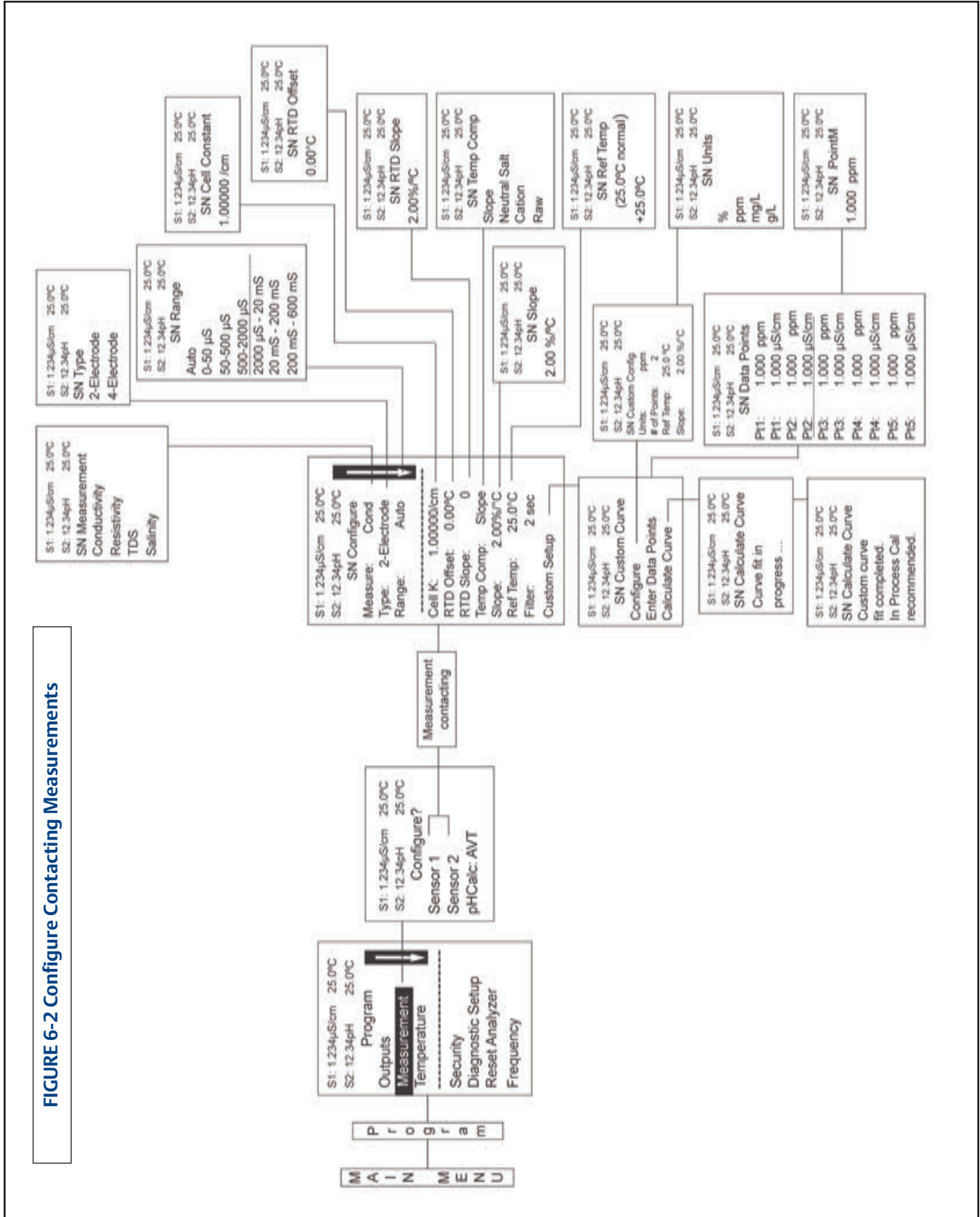

FIGURE 6-3 Configure Toroidal Measurements

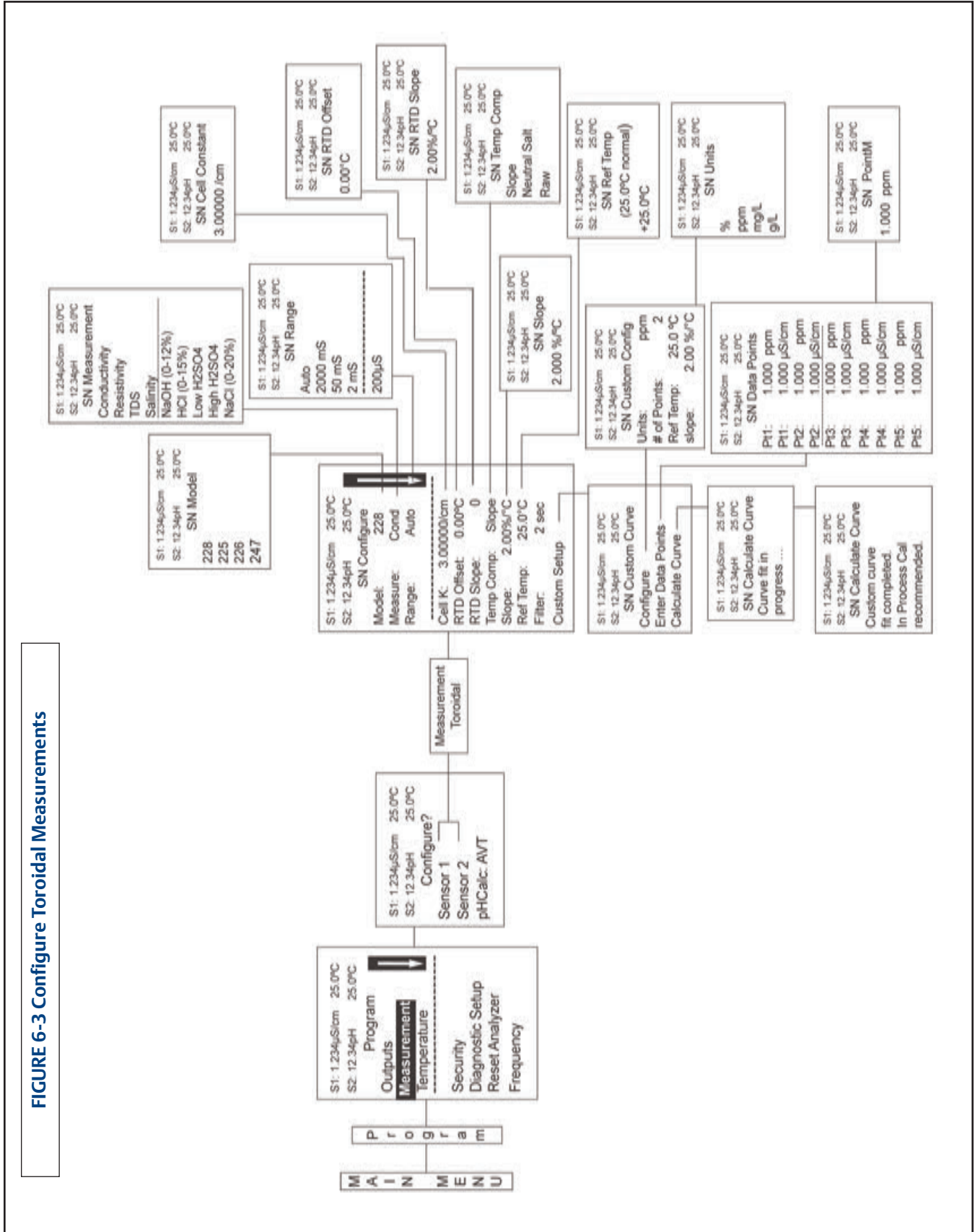
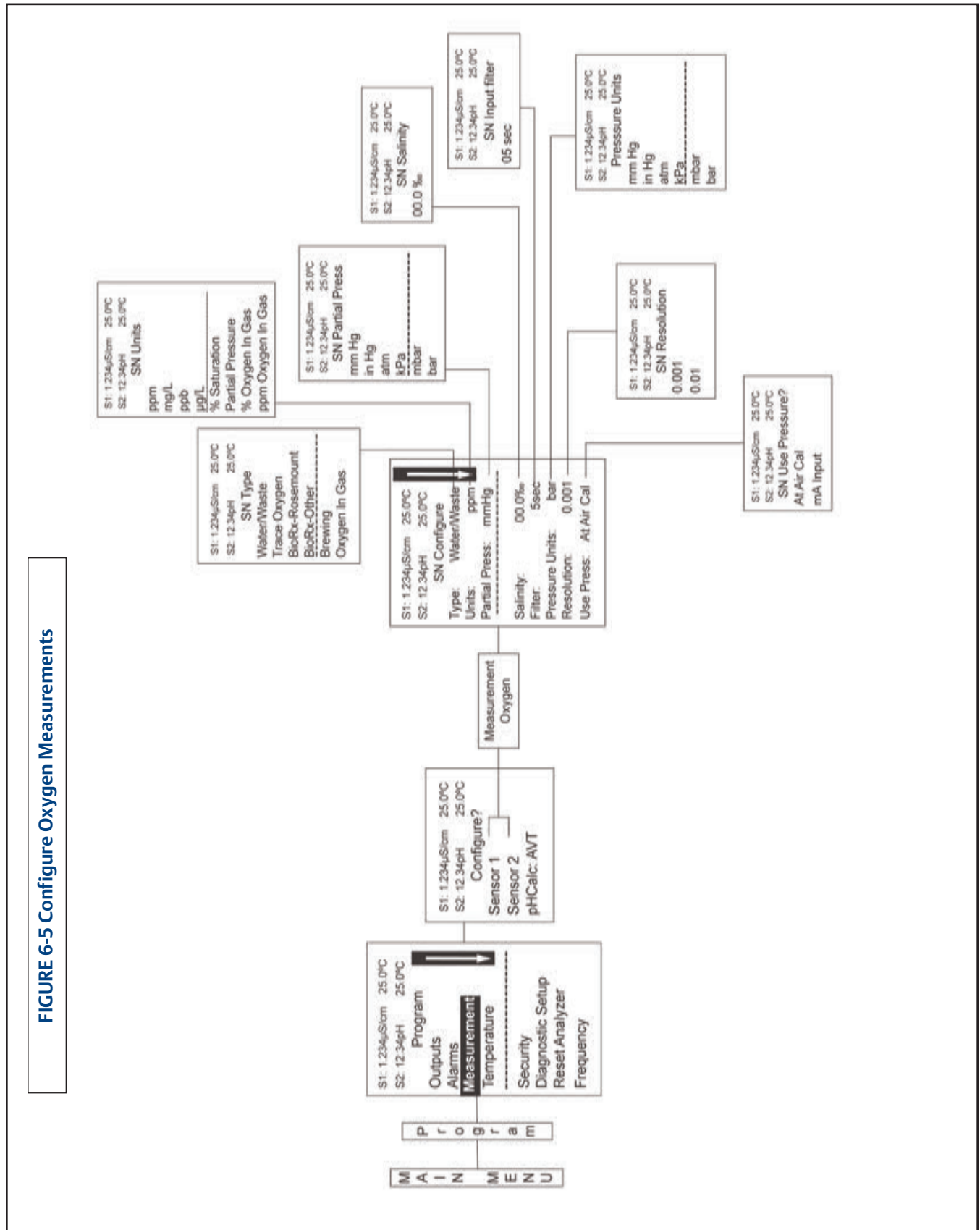

FIGURE 6-5 Configure Oxygen Measurements



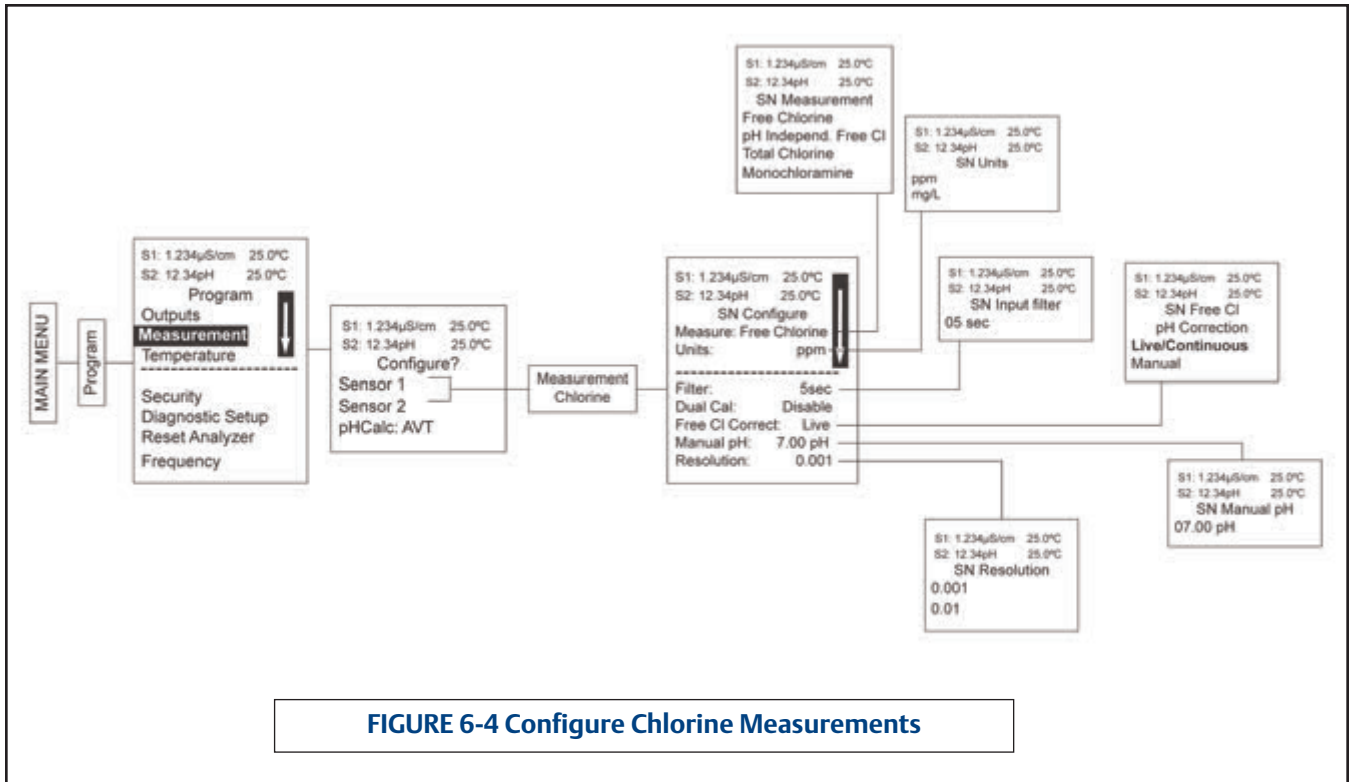

FIGURE 6-4 Configure Chlorine Measurements

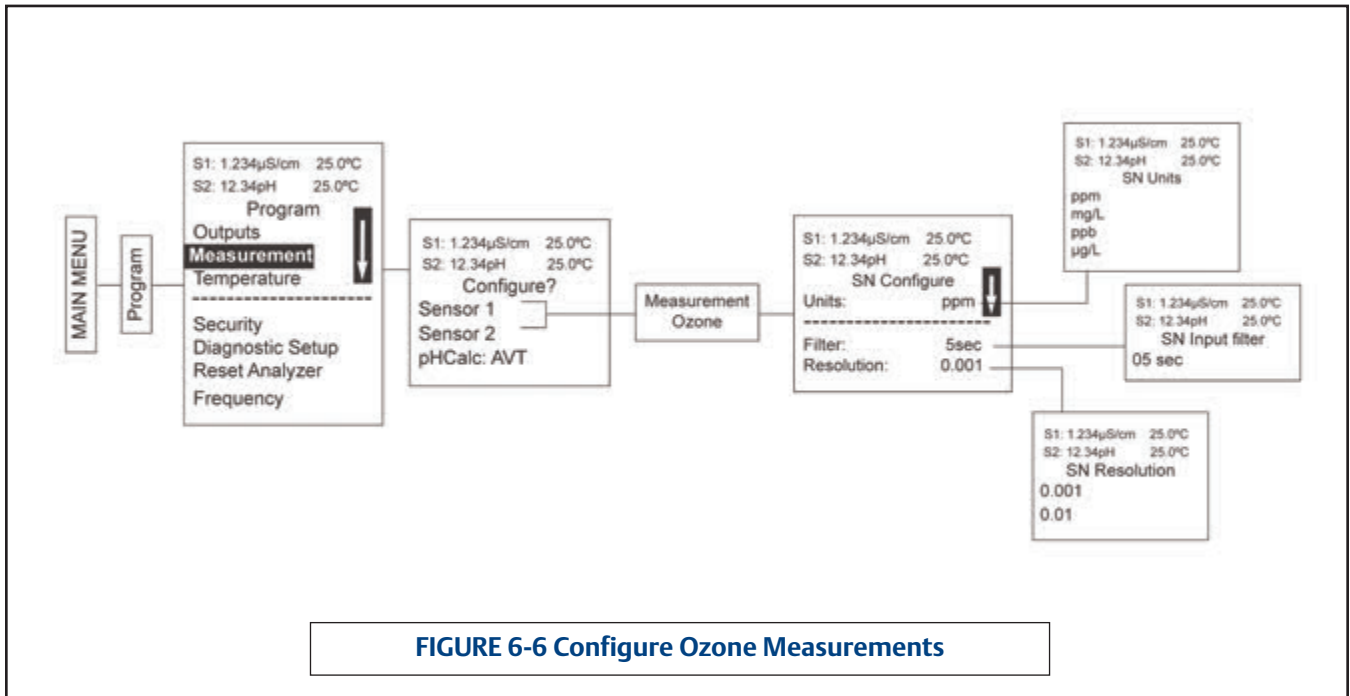

FIGURE 6-6 Configure Ozone Measurements

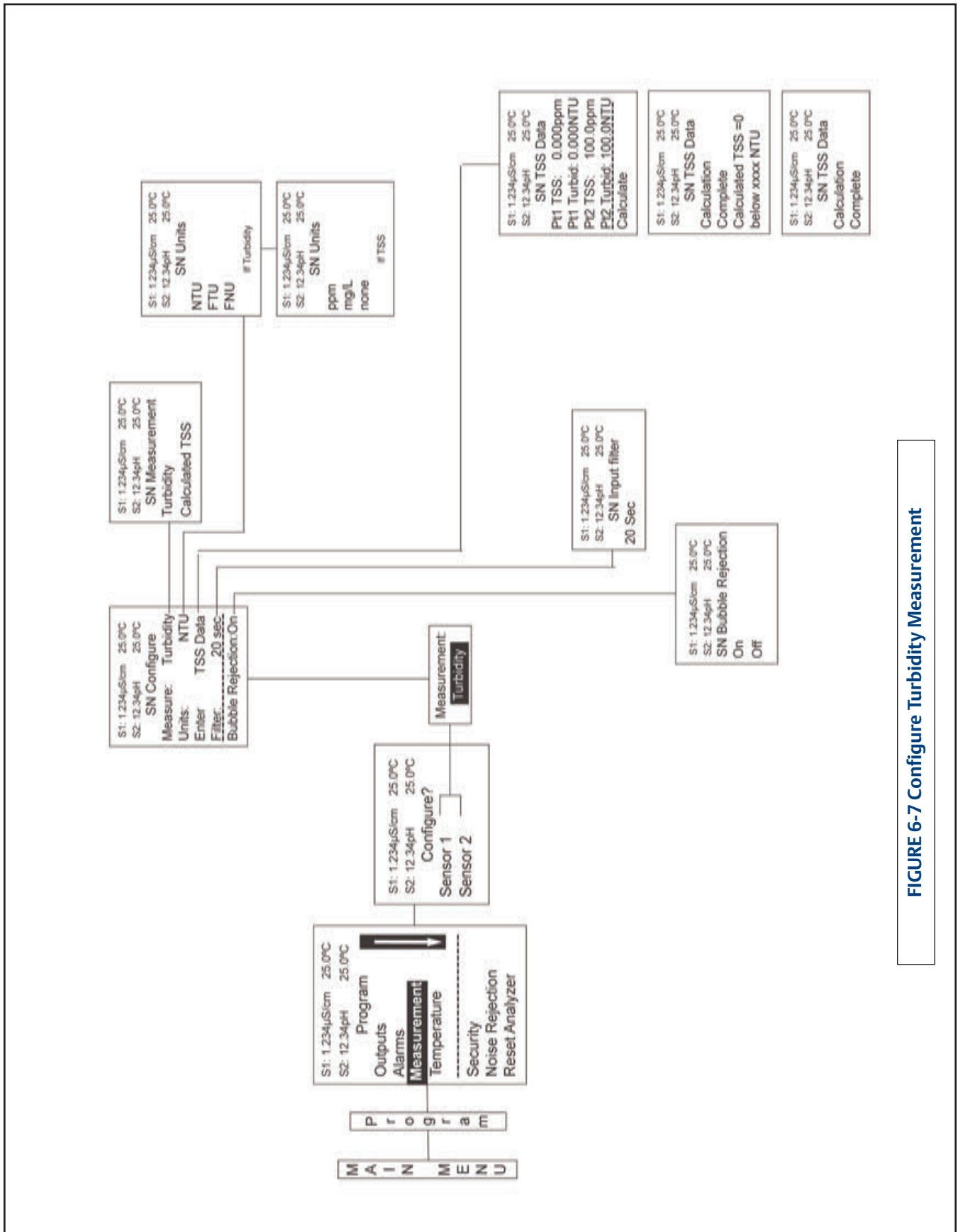

FIGURE 6-7 Configure Turbidity Measurement

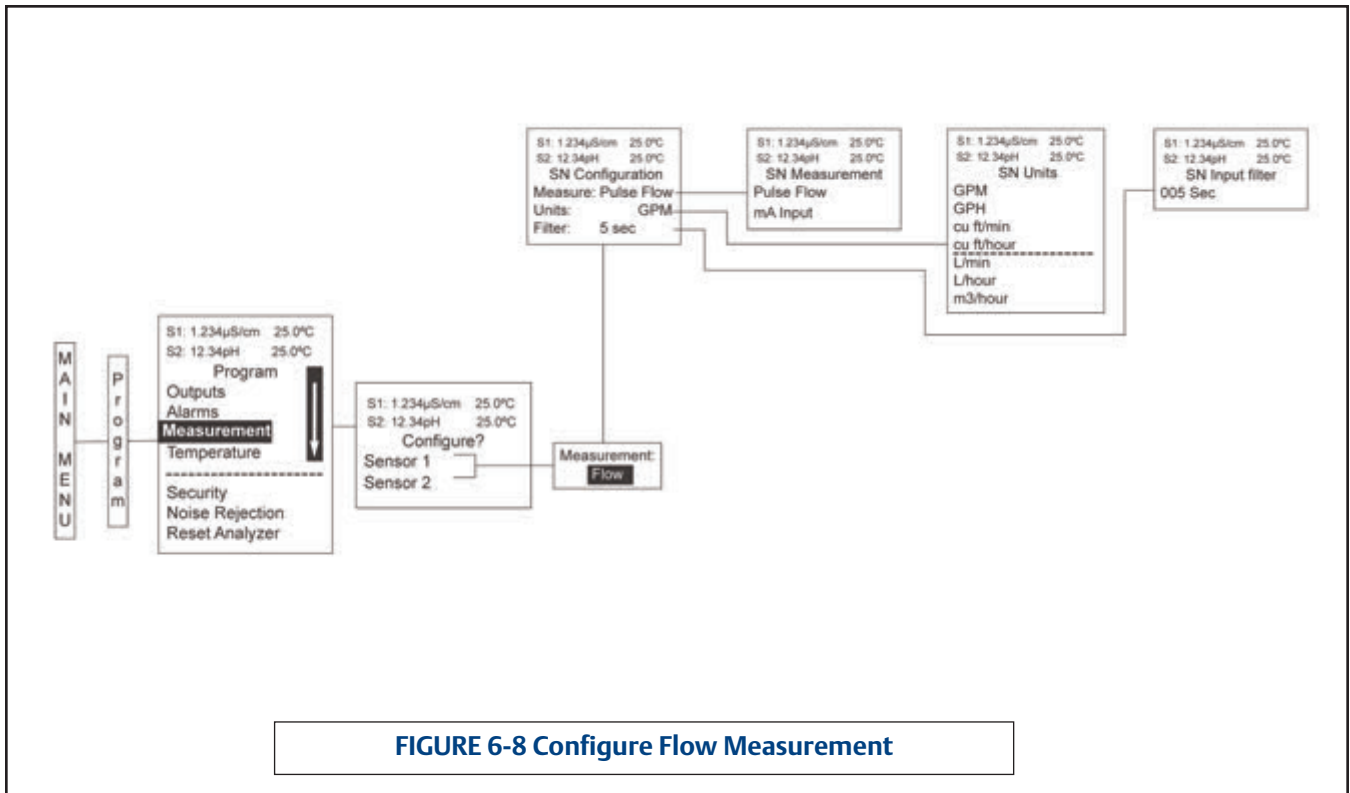

FIGURE 6-8 Configure Flow Measurement

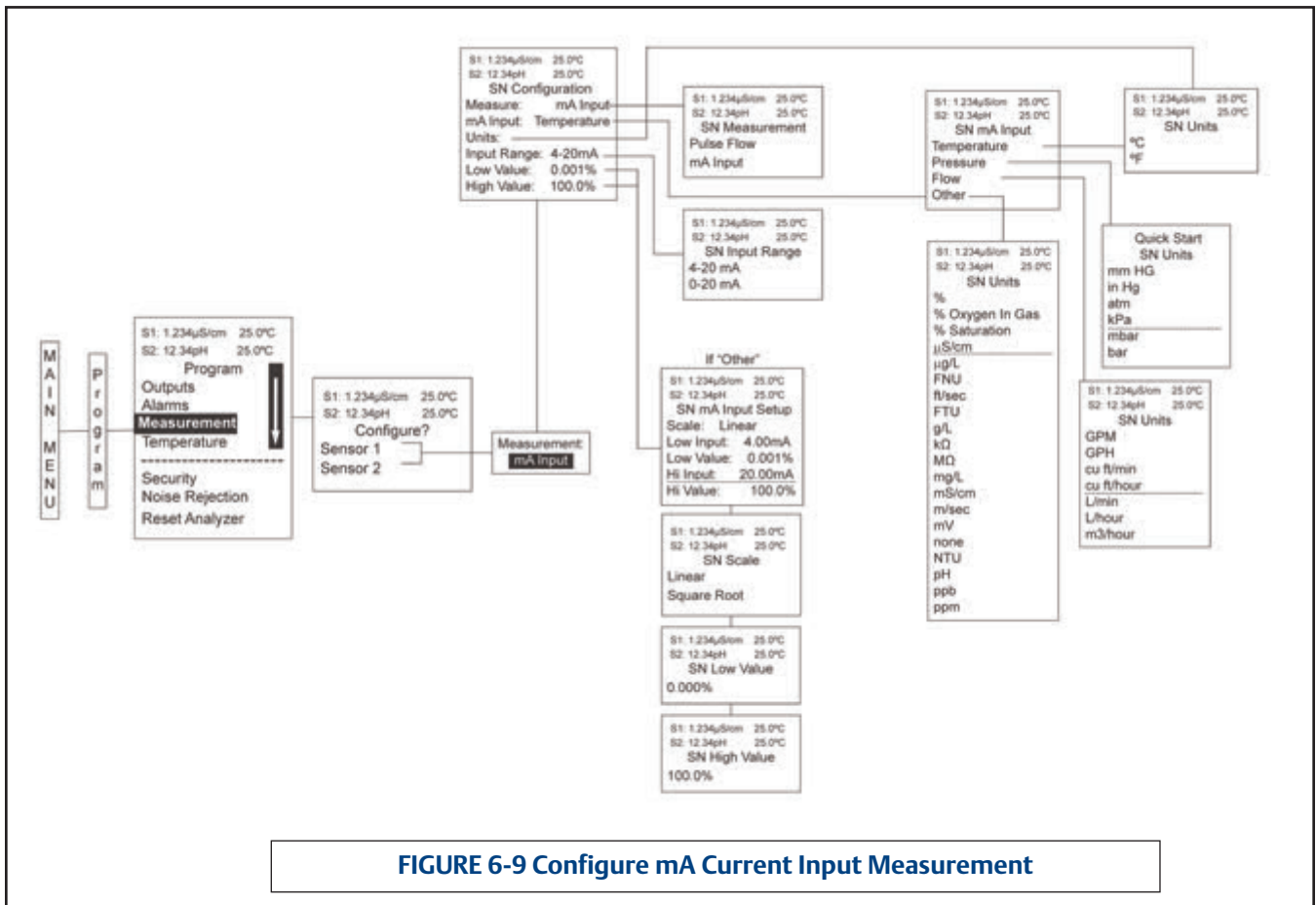

FIGURE 6-9 Configure mA Current Input Measurement

Section 7.0 Calibration

7.1 Calibration – Introduction

7.2 Ph Calibration

7.3 Orp Calibration

7.4 Contacting Conductivity Calibration

7.5 Toroidal Conductivity Calibration

7.6 Chlorine Calibration

7.6.1 Free Chlorine

7.6.2 Total Chlorine

7.6.3 Monochloramine

7.6.4 pH-Independent Free Chlorine

7.7 Oxygen Calibration

7.8 Ozone Calibration

7.9 Temperature Calibration

7.10 Turbidity Calibration

7.11 Flow Calibration

7.1 Calibration – Introduction

Calibration is the process of adjusting or standardizing the analyzer to a lab test or a calibrated laboratory instrument, or standardizing to some known reference (such as a commercial buffer).

The auto-recognition feature of the analyzer will enable the appropriate calibration screens to allow calibration for any single sensor configuration or dual sensor configuration of the analyzer. Completion of Quick Start upon first power up enables live measurements but does not ensure accurate readings in the lab or in process. Calibration should be performed with each attached sensor to ensure accurate, repeatable readings.

This section covers the following programming and configuration functions:

1. Auto buffer cal for pH (pH Cal - Sec.7.2)
2. Manual buffer cal for pH (pH Cal - Sec.7.2)
3. Set calibration stabilization criteria for pH (pH Cal - Sec.7.2)
4. Standardization calibration (1-point) for pH, ORP and Redox (pH Cal - Sec.7.2 and 7.3)
5. Entering the cell constant of a conductivity sensor (Conductivity Cal - Sec. 7.4 and 7.5)
6. Calibrating the sensor in a conductivity standard (Conductivity Cal - Sec. 7.4 and 7.5)
7. Calibrating the analyzer to a laboratory instrument (Contacting Conductivity Cal - Sec.7.4)
8. Zeroing an chlorine, oxygen or ozone sensor (Amperometric Cal - Sec's 7.6, 7.7, 7.8)
9. Calibrating an oxygen sensor in air (Oxygen Cal - Sec's 7.6)
10. Calibrating the sensor to a sample of known concentration (Amperometric Cal - Sec's 7.6, 7.7, 7.8)
11. Enter a manual reference temperature for temperature compensation of the process measurement

7.2 pH Calibration

7.2.1 Description

New sensors must be calibrated before use. Regular recalibration is also necessary. Use auto calibration instead of manual calibration. Auto calibration avoids common pitfalls and reduces errors. The analyzer recognizes the buffers and uses temperature-corrected pH values in the calibration. Once the Model 1056 successfully completes the calibration, it calculates and displays the calibration slope and offset. The slope is reported as the slope at 25°C.

THIS SECTION DESCRIBES HOW TO CALIBRATE THE MODEL 1056 WITH A pH SENSOR. THE FOLLOWING CALIBRATION ROUTINES ARE COVERED.

TABLE 7-1 pH Calibration Routines

Measure	Sec.	Menu function:	default	Description
pH	7.2.2	Auto Calibration -	pH	2 point buffer calibration with auto buffer recognition
	7.2.3	Manual Calibration -	pH	2 point buffer calibration with manual buffer value entry
	7.2.4	Entering A Known Slope Value -	pH	Slope calibration with manual entry of known slope value
	7.2.5	Standardization -	pH	1 point buffer calibration with manual buffer value entry

A detailed flow diagram is provided at the end of Sec. 7 to guide you through the calibration routines.

To calibrate pH:

1. Press the **MENU** button
2. Select Calibrate. Press **ENTER**.
3. Select **Sensor 1** or **Sensor 2** corresponding to pH. Press **ENTER**.
4. Select **pH**. Press **ENTER**.

The following screen will appear. To calibrate pH or Temperature scroll to the desired item and press **ENTER**.

S1: 1.234µS/cm	25.0°C
S2: 12.34pH	25.0°C
SN Calibrate?	
pH	
Temperature	

The following sub-sections show the initial display screen that appears for each calibration routine. Use the **flow diagram for pH calibration** at the end of Sec. 7 and the live screen prompts to complete calibration.

7.2.2 Auto Calibration — pH

This screen appears after selecting **pH calibration**.

S1: 1.234µS/cm	25.0°C
S2: 12.34pH	25.0°C
SN pH Cal	
Buffer Cal	
Standardize	
Slope:	59.16mV/pH
Offset:	600 mV

Note that pH auto calibration criteria can be changed. The following criteria can be adjusted:

- Stabilization time (default 10 sec.)
- Stabilization pH value (default 0.02 pH)
- Type of Buffer used for AUTO CALIBRATION (default is Standard, non-commercial buffers).

The following commercial buffer tables are recognized by the analyzer:

- Standard (NIST plus pH7)
- DIN 19267
- Ingold
- Merck

The following screen will appear to allow adjustment of these criteria:

S1: 1.234µS/cm	25.0°C
S2: 12.34pH	25.0°C
SN Setup	
Stable Time:	10 sec
Stable Delta:	0.02 pH
Buffer:	Standard

The following screen will appear if the auto cal is successful. The screen will return to the pH Buffer Cal Menu.

```
S1: 1.234µS/cm  25.0°C
S2: 12.34pH    25.0°C
      SN pH Auto Cal
Slope: 59.16 mV/pH
Offset:      60 mV
```

The following screens may appear if the auto cal is unsuccessful.

1. A High Slope Error will generate this screen display:

```
S1: 1.234µS/cm  25.0°C
S2: 12.34pH    25.0°C
      SN pH Auto Cal
High Slope Error
Calculated: 62.11 mV/pH
Max: 62.00 mV/pH
Press EXIT
```

2. A Low Slope Error will generate this screen display:

```
S1: 1.234µS/cm  25.0°C
S2: 12.34pH    25.0°C
      SN pH Auto Cal
Low Slope Error
Calculated: 39.11mV/pH
Min: 40.00 mV/pH
Press EXIT
```

3. An Offset Error will generate this screen display:

```
S1: 1.234µS/cm  25.0°C
S2: 12.34pH    25.0°C
      SN pH Auto Cal
Offset Error
Calculated: 61.22mV
Max:      60.00mV
Press EXIT
```

7.2.3 Manual Calibration — pH

New sensors must be calibrated before use. Regular recalibration is also necessary. Use manual calibration if non-standard buffers are being used; otherwise, use auto calibration. Auto calibration avoids common pitfalls and reduces errors.

The adjacent appears after selecting Manual pH calibration.

tion.

```
S1: 1.234µS/cm  25.0°C
S2: 12.34pH    25.0°C
      SN pH Manual Cal
Buffer 1
Buffer 2
```

7.2.4 Entering A Known Slope Value — pH

If the electrode slope is known from other measurements, it can be entered directly in the Model 1056 analyzer. The slope must be entered as the slope at 25°C.

```
S1: 1.234µS/cm  25.0°C
S2: 12.34pH    25.0°C
      SN pH Slope@25°C
59.16 mV/pH
```

7.2.5 Standardization — pH

The pH measured by the Model 1056 analyzer can be changed to match the reading from a second or referee instrument. The process of making the two readings agree is called standardization. During standardization, the difference between the two pH values is converted to the equivalent voltage. The voltage, called the reference offset, is added to all subsequent measured cell voltages before they are converted to pH. If a standardized sensor is placed in a buffer solution, the measured pH will differ from the buffer pH by an amount equivalent to the standardization offset.

```
S1: 1.234µS/cm  25.0°C
S2: 12.34pH    25.0°C
      SN Enter Value
07.00pH
```

The following screen may appear if ORP Cal is unsuccessful. An Offset Error will generate this screen display:

```
S1: 1.234µS/cm 25.0°C
S2: 12.34pH 25.0°C
SN Standardize
Offset Error
Calculated: 96mV
Max: 60mV
Press EXIT
```

If the ORP Cal is successful, the screen will return to the Cal sub-menu.

7.3 ORP Calibration

7.3.1 Description

For process control, it is often important to make the measured ORP agree with the ORP of a standard solution. During calibration, the measured ORP is made equal to the ORP of a standard solution at a single point.

THIS SECTION DESCRIBES HOW TO CALIBRATE THE MODEL 1056 WITH AN ORP SENSOR. THE FOLLOWING CALIBRATION ROUTINE IS COVERED.

TABLE 7-2 ORP Calibration Routine

Measure	Sec.	Menu function: default	Description
ORP	7.3.2	Standardization — ORP	1 point buffer calibration with manual buffer value entry

A detailed flow diagram is provided at the end of Sec. 7 to guide you through the calibration routines.

To calibrate ORP:

1. Press the MENU button
2. Select Calibrate. Press ENTER.
3. Select Sensor 1 or Sensor 2 corresponding to ORP. Press ENTER.
4. Select ORP. Press ENTER.

The following screen will appear. To calibrate ORP or Temperature, scroll to the desired item and press ENTER.

```
S1: 1.234µS/cm 25.0°C
S2: 12.34pH 25.0°C
SN Calibrate?
ORP
Temperature
```

The following sub-sections show the initial display screen that appears for each calibration routine. Use the **flow diagram for ORP calibration** at the end of Sec. 7 and the live screen prompts to complete calibration.

7.3.2 Standardization — ORP

For process control, it is often important to make the measured ORP agree with the ORP of a standard solution. During calibration, the measured ORP is made equal to the ORP of a standard solution at a single point. This screen appears after selecting ORP calibration:

Cal sub-menu.

```
S1: 1.234µS/cm 25.0°C
S2: 12.34pH 25.0°C
SN Enter Value
+0600 mV
```

If the ORP Cal is successful, the screen will return to the

The following screen may appear if ORP Cal is unsuccessful.

```
S1: 1.234µS/cm 25.0°C
S2: 12.34pH 25.0°C
SN Standardize
Offset Error
Calculated: 61.22mV
Max: 60.00mV
Press EXIT
```

7.4 Contacting Conductivity Calibration

7.4.1 Description

PLACING A NEW CONDUCTIVITY SENSOR IN SERVICE
New conductivity sensors rarely need calibration. The cell constant printed on the label is sufficiently accurate for most applications.

CALIBRATING AN IN-SERVICE CONDUCTIVITY SENSOR
1. After a conductivity sensor has been in service for a period of time, recalibration may be necessary. There are three ways to calibrate a sensor.

- a. Use a standard instrument and sensor to measure the conductivity of the process stream. It is not necessary to remove the sensor from the process piping. The temperature correction used by the standard instrument may not exactly match the temperature correction used by the Model 1056. To avoid errors, turn off temperature correction in both the analyzer and the standard instrument.
- b. Place the sensor in a solution of known conductivity and make the analyzer reading match the conductivity of the

standard solution. Use this method if the sensor can be easily removed from the process piping and a standard is available. Be careful using standard solutions having conductivity less than 100 $\mu\text{S/cm}$. Low conductivity standards are highly susceptible to atmospheric contamination. Avoid calibrating sensors with 0.01/cm cell constants against conductivity standards having conductivity greater than 100 $\mu\text{S/cm}$. The resistance of these solutions may be too low for an accurate measurement. Calibrate sensors with 0.01/cm cell constant using method c.

c. To calibrate a 0.01/cm sensor, check it against a standard instrument and 0.01/cm sensor while both sensors are measuring water having a conductivity between 5 and 10 $\mu\text{S/cm}$. To avoid drift caused by absorption of atmospheric carbon dioxide, saturate the sample with air before making the measurements.

To ensure adequate flow past the sensor during calibration, take the sample downstream from the sensor. For best results, use a flow-through standard cell. If the process temperature is much different from ambient, keep connecting lines short and insulate the flow cell.

THIS SECTION DESCRIBES HOW TO CALIBRATE THE MODEL 1056 WITH AN ATTACHED CONTACTING CONDUCTIVITY SENSOR. THE FOLLOWING CALIBRATION ROUTINES ARE COVERED.

TABLE 7-3 Contacting Conductivity Calibration Routines

Measure	Sec.	Menu function:	default	Description
Contacting Conductivity	7.4.2	Cell K:	1.00000/cm	Enter the cell Constant for the sensor
	7.4.3	Zero Cal		Zero the analyzer with the sensor attached
	7.4.4	In Process Cal		Standardize the sensor to a known conductivity
	7.4.5	Meter Cal		Calibrate the analyzer to a lab conductivity instrument
	7.4.6	Cal Factor:	0.95000/cm	Enter the Cal Factor for 4-Electrode sensors from the sensor tag

A detailed flow diagram is provided at the end of Sec. 7 to guide you through the calibration routines

To calibrate contacting conductivity:

1. Press the MENU button
2. Select Calibrate. Press ENTER.
3. Select Sensor 1 or Sensor 2 corresponding to contacting conductivity. Press ENTER.
4. Select Conductivity. Press ENTER.

The adjacent screen will appear. To calibrate Conductivity or Temperature, scroll to the desired item and press ENTER.

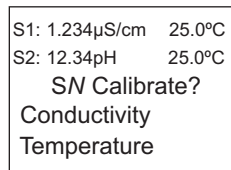

The following sub-sections show the initial display screen that appears for each calibration routine. Use the **flow diagram for Conductivity calibration** at the end of Sec. 7 and the live screen prompts for each routine to complete calibration.

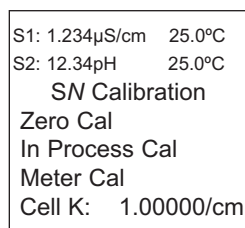

The adjacent screen appears after selecting **Conductivity calibration**:

7.4.2 Entering The Cell Constant

New conductivity sensors rarely need calibration. The cell constant printed on the label is sufficiently accurate for most applications. The cell constant should be entered:

- When the unit is installed for the first time
- When the probe is replaced

The display screen for entering a cell Constant for the sensor is shown. The default value is displayed in **bold type**.

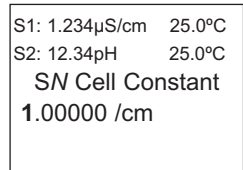

7.4.3 Zeroing The Instrument

This procedure is used to compensate for small offsets to the conductivity signal that are present even when there is no conductivity to be measured. This procedure is affected by the length of extension cable and should always be repeated if any changes in extension cable or sensor have been made. **Electrically connect the conductivity probe as it will actually be used and place the measuring portion of the probe in air. Be sure the probe is dry.**

The adjacent screen will appear after selecting **Zero Cal** from the Conductivity Calibration screen:

The adjacent screen will appear if zero Cal is successful. The screen will return to the conductivity Cal Menu.

The adjacent screen may appear if zero Cal is unsuccessful.

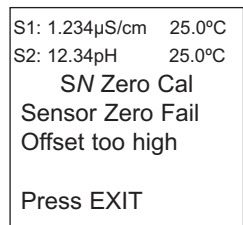
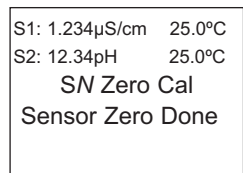
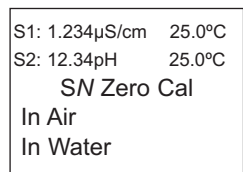

7.4.4 Calibrating The Sensor In A Conductivity Standard (In Process CAL)

This procedure is used to calibrate the sensor and analyzer against a solution of known conductivity. This is done by submerging the probe in the sample of known conductivity, then adjusting the displayed value, if necessary, to correspond to the conductivity value of the sample. Turn temperature correction off and use the conductivity of the standard. Use a calibrated thermometer to measure temperature. The probe must be cleaned before performing this procedure.

The adjacent screen will appear after selecting **In Process Cal** from the Conductivity Calibration screen:

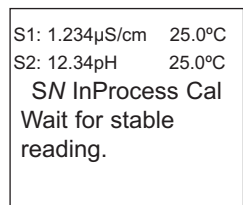

The adjacent screen will appear if In Process Cal is successful. The screen will return to the conductivity Cal Menu.

```
S1: 1.234µS/cm 25.0°C
S2: 12.34pH 25.0°C
SN InProcess Cal
Updated cell
constant:
1.00135/cm
```

The adjacent screen may appear if In Process Cal is unsuccessful. The screen will return to the conductivity Cal Men

```
S1: 1.234µS/cm 25.0°C
S2: 12.34pH 25.0°C
SN InProcess Cal
Calibration
Error

Press EXIT
```

7.4.5 Calibrating The Sensor To A Laboratory Instrument (Meter Cal)

This procedure is used to check and correct the conductivity reading of the Model 1056 using a laboratory conductivity instrument. This is done by submerging the conductivity probe in a bath and measuring the conductivity of a grab sample of the same bath water with a separate laboratory instrument. The Model 1056 reading is then adjusted to match the conductivity reading of the lab instrument.

The adjacent screen will appear after selecting **Meter Cal** from the Conductivity Calibration screen:

```
S1: 1.234µS/cm 25.0°C
S2: 12.34pH 25.0°C
SN Meter Cal
Use precision
resistors only
```

After pressing ENTER, the display shows the live value measured by the sensor

```
S1: 1.234µS/cm 25.0°C
S2: 12.34pH 25.0°C
SN Enter Value
xx.xx kΩ
```

If the meter cal is successful the screen will return to the conductivity Cal Menu.

```
S1: 1.234µS/cm 25.0°C
S2: 12.34pH 25.0°C
SN Meter Cal
Calibration
Error

Press EXIT
```

The adjacent screen will appear if Meter Cal is unsuccessful. The screen will return to the conductivity Cal Menu.

7.4.6 Cal Factor

Upon initial installation and power up, if **4-electrode** was selected for the sensor type in the **Quick Start** menus, the user enters a Cell Constant and a "Cal Factor" using the instrument keypad. The cell constant is needed to convert measured conductance to conductivity as displayed on the analyzer screen. The "Cal Factor" entry is needed increase the accuracy of the live conductivity readings, especially at low conductivity readings below 20uS/cm. Both the Cell Constant and the "Cal Factor" are printed on the tag attached to the 4-electrode sensor/cable.

The display screen for entering Cal Factor is shown. The default value is displayed in **bold type**. If necessary after initial installation and start-up, enter the "Cal Factor" as printed on the sensor tag.

```
S1: 1.234µS/cm 25.0°C
S2: 12.34pH 25.0°C
SN Cal Factor
0.95000 /cm
```

7.5 Toroidal Conductivity Calibration

7.5.1 Description

Calibration is the process of adjusting or standardizing the analyzer to a lab test or a calibrated laboratory instrument, or standardizing to some known reference (such as a conductivity standard). This section contains procedures for the first time use and for routine calibration of the Model 1056 analyzer.

THIS SECTION DESCRIBES HOW TO CALIBRATE THE MODEL 1056 WITH AN ATTACHED INDUCTIVE/TOROIDAL CONDUCTIVITY SENSOR. THE FOLLOWING CALIBRATION ROUTINES ARE COVERED

TABLE 7-4 Toroidal Conductivity Calibration

Measure	Sec.	Calibration function: default value	Description
Toroidal Conductivity	7.5.2	Cell K: 3.00000/cm	Enter the cell Constant for the sensor
	7.5.3	Zero Cal	Zeroing the analyzer with the sensor attached
	7.5.4	In Process Cal	Standardizing the sensor to a known conductivity

A detailed flow diagram is provided at the end of Sec. 7 to guide you through the calibration routines.

To calibrate toroidal conductivity:

1. Press the **MENU** button
2. Select **Calibrate**. Press ENTER.
3. Select **Sensor 1** or **Sensor 2** corresponding to Toroidal Conductivity. Press ENTER.
4. Select **Conductivity**. Press ENTER.

The adjacent screen will appear. To calibrate Toroidal Conductivity or Temperature, scroll to the desired item and press ENTER

S1: 1.234µS/cm	25.0°C
S2: 12.34pH	25.0°C
SN Calibrate?	
Conductivity	
Temperature	

The following sub-sections show the initial display screen that appears for each calibration routine. Use the **flow diagram for Conductivity calibration** at the end of Sec. 7 and the live screen prompts to complete calibration.

S1: 1.234µS/cm	25.0°C
S2: 12.34pH	25.0°C
SN Calibration	
Zero Cal	
In Process Cal	
Cell K:	1.00000/cm

The adjacent screen appears after selecting **Conductivity calibration**:

7.5.2 Entering The Cell Constant

New conductivity sensors rarely need calibration. The cell constant printed on the label is sufficiently accurate for most applications. The cell constant should be entered:

- When the unit is installed for the first time
- When the probe is replaced
- During troubleshooting

This procedure sets up the analyzer for the probe type connected to the analyzer. Each type of probe has a specific cell constant:

The display screen for entering a cell constant for the sensor is shown. The default value is displayed in **bold type**.

```
S1: 1.234µS/cm 25.0°C
S2: 12.34pH 25.0°C
      SN Cell Constant
      3.00000 /cm
```

7.5.3 Zeroing The Instrument

This procedure is used to compensate for small offsets to the conductivity signal that are present even when there is no conductivity to be measured. This procedure is affected by the length of extension cable and should always be repeated if any changes in extension cable or sensor have been made. Electrically connect the conductivity probe as it will actually be used and place the measuring portion of the probe in air.

The adjacent screen will appear after selecting **Zero Cal** from the Conductivity Calibration screen:

```
S1: 1.234µS/cm 25.0°C
S2: 12.34pH 25.0°C
      SN Zero Cal
In Air
In Water
```

The adjacent screen will appear if zero Cal is successful. The screen will return to the conductivity Cal Menu.

```
S1: 1.234µS/cm 25.0°C
S2: 12.34pH 25.0°C
      SN Zero Cal
      Sensor Zero Done
```

The adjacent screen may appear if zero Cal is unsuccessful.

```
S1: 1.234µS/cm 25.0°C
S2: 12.34pH 25.0°C
      SN Zero Cal
      Sensor Zero Fail
      Offset too high

      Press EXIT
```

7.5.4 Calibrating The Sensor In A Conductivity Standard (In Process Cal)

This procedure is used to check and correct the conductivity reading of the Model 1056 to ensure that the reading is accurate. This is done by submerging the probe in the sample of known conductivity, then adjusting the displayed value, if necessary, to correspond to the conductivity value of the sample. The probe must be cleaned before performing this procedure. The temperature reading must also be checked and standardized if necessary, prior to performing this procedure.

The adjacent screen will appear after selecting In Process Cal from the Conductivity Calibration screen:

```
S1: 1.234µS/cm 25.0°C
S2: 12.34pH 25.0°C
      SN InProcess Cal
      Wait for stable
      reading.
```

The following screen will appear if In Process Cal is successful. The screen will return to the conductivity Cal Menu.

```
S1: 1.234µS/cm  25.0°C  
S2: 12.34pH    25.0°C  
  SN InProcess Cal  
  Updated cell  
  constant:  
  3.01350/cm
```

This screen may appear if In Process Cal is unsuccessful. The screen will return to the conductivity Cal Menu.

```
S1: 1.234µS/cm  25.0°C  
S2: 12.34pH    25.0°C  
  SN InProcess Cal  
  Calibration  
  Error  
  
Press EXIT
```

7.6 Calibration — Chlorine

With a Chlorine measurement board and the appropriate sensor, Model 1056 can measure any of four variants of Chlorine:

- Free Chlorine
- Total Chlorine
- Monochloramine
- pH-independent Free Chlorine

The section describes how to calibrate any compatible amperometric chlorine sensor. The following calibration routines are covered in the family of supported Chlorine sensors:

- **Air Cal**
- **Zero Cal**
- **In Process Cal**

7.6.1 Calibration — Free Chlorine

7.6.1.1 Description

A free chlorine sensor generates a current directly proportional to the concentration of free chlorine in the sample. Calibrating the sensor requires exposing it to a solution containing no chlorine (zero standard) and to a solution containing a known amount of chlorine (full-scale standard). The **zero calibration** is necessary because chlorine sensors, even when no chlorine is in the sample, generate a small current called the residual current. The analyzer compensates for the residual current by subtracting it from the measured current before converting the result to a chlorine value. New sensors require zeroing before being placed in service, and sensors should be zeroed whenever the electrolyte solution is replaced. Either of the following makes a good zero standard:

- Deionized water containing about 500 ppm sodium chloride. Dissolve 0.5 grams (1/8 teaspoonful) of table salt in 1 liter of water. **DO NOT USE DEIONIZED WATER ALONE FOR ZEROING THE SENSOR. THE CONDUCTIVITY OF THE ZERO WATER MUST BE GREATER THAN 50 µS/cm.**
- Tap water known to contain no chlorine. Expose tap water to bright sunlight for at least 24 hours.

The purpose of the In **Process calibration** is to establish the slope of the calibration curve. Because stable chlorine standards do not exist, **the sensor must be calibrated against a test run on a grab sample of the process liquid.**

Several manufacturers offer portable test kits for this purpose. Observe the following precautions when taking and testing the grab sample.

- Take the grab sample from a point as close to the sensor as possible. Be sure that taking the sample does not alter the flow of the sample to the sensor. It is best to install the sample tap just downstream from the sensor.
- Chlorine solutions are unstable. Run the test immediately after taking the sample. Try to calibrate the sensor when the chlorine concentration is at the upper end of the normal operating range.

THIS SECTION DESCRIBES HOW TO CALIBRATE THE MODEL 1056 WITH A FREE CHLORINE SENSOR. THE FOLLOWING CALIBRATION ROUTINES ARE COVERED.

TABLE 7-5 Free Chlorine Calibration Routines

Measure	Sec.	Calibration function: default value	Description
Free Chlorine	7.6.1.2	Zero Cal	Zeroing the sensor in solution with zero free chlorine
	7.6.1.3	In Process Cal	Standardizing to a sample of known chlorine concentration

A detailed flow diagram is provided at the end of Sec. 7 to guide you through the calibration routines.

To calibrate free chlorine:

1. Press the **MENU** button
2. Select **Calibrate**. Press ENTER.
3. Select **Sensor 1** or **Sensor 2** corresponding to Free Chlorine. Press ENTER.
4. Select **Free Chlorine**. Press ENTER.

The adjacent screen will appear. To calibrate Free Chlorine or Temperature, scroll to the desired item and press ENTER.

```
S1: 1.234µS/cm  25.0°C
S2: 12.34pH    25.0°C
  SN Calibrate?
Free Chlorine
Temperature
```

The following sub-sections show the initial display screen that appears for each calibration routine. Use the **flow diagram for Chlorine calibration** at the end of Sec. 7 and the live screen prompts to complete calibration.

```
S1: 1.234µS/cm  25.0°C
S2: 12.34pH    25.0°C
  SN Calibration
Zero Cal
In Process Cal
```

The adjacent screen appears after selecting **Free Chlorine calibration**:

7.6.1.2 Zeroing the sensor

The adjacent screen will appear during Zero Cal. Be sure sensor has been running in zero solution for at least two hours before starting zero step.

```
S1: 1.234µS/cm  25.0°C
S2: 12.34pH    25.0°C
  SN Zero Cal
Zeroing
Wait
```

The adjacent screen will appear if In Zero Cal is successful. The screen will return to the Amperometric Cal Menu.

```
S1: 1.234µS/cm  25.0°C
S2: 12.34pH    25.0°C
  SN Zero Cal
Sensor zero done
```

The adjacent screen may appear if In Zero Cal is unsuccessful. The screen will return to the Amperometric Cal Menu.

```
S1: 1.234µS/cm  25.0°C
S2: 12.34pH    25.0°C
  SN Zero Cal
Sensor zero failed

Press EXIT
```

7.6.1.3 In Process Calibration

The adjacent screen will appear prior to In Process Cal

```
S1: 1.234µS/cm  25.0°C
S2: 12.34pH    25.0°C
  SN InProcess Cal
Wait for stable
reading.
```

If the In Process Cal is successful, the screen will return to the Cal sub-menu.

The adjacent screen may appear if In Zero Cal is unsuccessful. The screen will return to the Amperometric Cal Menu.

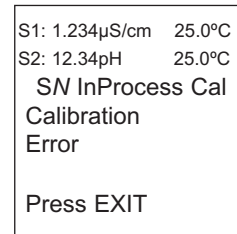

7.6.2 Calibration — Total Chlorine

7.6.2.1 Description

Total chlorine is the sum of free and combined chlorine. The continuous determination of total chlorine requires two steps. First, the sample flows into a conditioning system (TCL) where a pump continuously adds acetic acid and potassium iodide to the sample. The acid lowers the pH, which allows total chlorine in the sample to quantitatively oxidize the iodide in the reagent to iodine. In the second step, the treated sample flows to the sensor. The sensor is a membrane-covered amperometric sensor, whose output is proportional to the concentration of iodine. Because the concentration of iodine is proportional to the concentration of total chlorine, the analyzer can be calibrated to read total chlorine. Because the sensor really measures iodine, calibrating the sensor requires exposing it to a solution containing no iodine (zero standard) and to a solution containing a known amount of iodine (full-scale standard). The **Zero calibration** is necessary because the sensor, even when no iodine is present, generates a small current called the residual current. The analyzer compensates for the residual current by subtracting it from the measured current before converting the result to a total chlorine value. New sensors require zeroing before being placed in service, and sensors should be

zeroed whenever the electrolyte solution is replaced. The best zero standard is deionized water.

The purpose of the **In Process Calibration** is to establish the slope of the calibration curve.

Because stable total chlorine standards do not exist, **the sensor must be calibrated against a test run on a grab sample of the process liquid**. Several manufacturers offer portable test kits for this purpose. Observe the following

precautions when taking and testing the grab sample:

- Take the grab sample from a point as close as possible to the inlet of the TCL sample conditioning system. Be sure that taking the sample does not alter the flow through the TCL.
- Chlorine solutions are unstable. Run the test immediately after taking the sample. Try to calibrate the sensor when the chlorine concentration is at the upper end of the normal operating range.

Note this measurement must be made using the Model TCL total chlorine sample conditioning system.

THIS SECTION DESCRIBES HOW TO CALIBRATE THE MODEL 1056 WITH AN ATTACHED TOTAL CHLORINE SENSOR. THE FOLLOWING CALIBRATION ROUTINES ARE COVERED.

TABLE 7- 6 Total Chlorine Calibration Routines

Measure	Sec.	Calibration function: default value	Description
Total Chlorine	7.6.2.2	Zero Cal	Zeroing the sensor in solution with zero total chlorine
	7.6.2.3	In Process Cal	Standardizing to a sample of known chlorine concentration

A detailed flow diagram is provided at the end of Sec. 7 to guide you through the calibration routines.

To calibrate total chlorine:

1. Press the **MENU** button
2. Select **Calibrate**. Press ENTER.
3. Select **Sensor 1** or **Sensor 2** corresponding to Total Chlorine. Press ENTER.
4. Select **Total Chlorine**. Press ENTER.

The adjacent screen will appear. To calibrate Total Chlorine or Temperature, scroll to the desired item and press ENTER

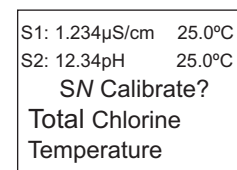

The following sub-sections provide you with the initial display screen that appears for each calibration routine. Use the **flow diagram for Chlorine calibration** at the end of Sec. 7 and the live screen prompts to complete calibration.

This adjacent screen appears after selecting **Total Chlorine calibration**:

7.6.2.2 Zeroing The Sensor

The adjacent screen will appear during Zero Cal. Be sure sensor has been running in zero solution for at least two hours before starting zero step.

The adjacent screen will appear if In Zero Cal is successful. The screen will return to the Amperometric Cal Menu.

The adjacent screen may appear if In Zero Cal is unsuccessful. The screen will return to the Amperometric Cal Menu.

7.6.2.3 In Process Calibration

The adjacent screen will appear prior to In Process Cal

If the In Process Cal is successful, the screen will return to the Cal sub-menu.

The adjacent screen may appear if In Process Cal is unsuccessful. The screen will return to the Amperometric Cal Menu.

S1: 1.234µS/cm 25.0°C
 S2: 12.34pH 25.0°C
 SN Calibration
 Zero Cal
 In Process Cal

S1: 1.234µS/cm 25.0°C
 S2: 12.34pH 25.0°C
 SN Zero Cal
 Zeroing
 Wait

S1: 1.234µS/cm 25.0°C
 S2: 12.34pH 25.0°C
 SN Zero Cal
 Sensor zero done

S1: 1.234µS/cm 25.0°C
 S2: 12.34pH 25.0°C
 SN Zero Cal
 Sensor zero failed
 Press EXIT

S1: 1.234µS/cm 25.0°C
 S2: 12.34pH 25.0°C
 SN InProcess Cal
 Wait for stable reading.

S1: 1.234µS/cm 25.0°C
 S2: 12.34pH 25.0°C
 SN InProcess Cal
 Calibration error
 Press EXIT

7.6.3 Calibration - Monochloramine

7.6.3.1 Description

A monochloramine sensor generates a current directly proportional to the concentration of monochloramine in the sample. Calibrating the sensor requires exposing it to a solution containing no monochloramine (zero standard) and to a solution containing a known amount of monochloramine (full-scale standard). The **Zero calibration** is necessary because monochloramine sensors, even when no monochloramine is in the sample, generate a small current called the residual or zero current. The analyzer compensates for the residual current by subtracting it from the measured current before converting the result to a monochloramine value. New sensors require zeroing before being placed in service, and sensors should be zeroed whenever the electrolyte solution is replaced. The best zero standard is deionized water.

The purpose of the **In Process calibration** is to establish the slope of the calibration curve. Because stable monochloramine standards do not exist, **the sensor must be calibrated against a test run on a grab sample of the process liquid**. Several manufacturers offer portable test kits for this purpose. Observe the following precautions when taking and testing the grab sample.

- Take the grab sample from a point as close to the sensor as possible. Be sure that taking the sample does not alter the flow of the sample to the sensor. It is best to install the sample tap just downstream from the sensor.
- Monochloramine solutions are moderately unstable. Run the test as soon as possible after taking the sample. Try to calibrate the sensor when the monochloramine concentration is at the upper end of the normal operating range.

THIS SECTION DESCRIBES HOW TO CALIBRATE THE MODEL 1056 WITH AN ATTACHED MONOCHLORAMINE SENSOR. THE FOLLOWING CALIBRATION ROUTINES ARE COVERED.

TABLE 7-7 Monochloramine Calibration Routines

Measure	Sec.	Calibration function: default value	Description
Monochloramine	7.6.3.2	Zero Cal	Zeroing the sensor in solution with zero monochloramine
	7.6.3.3	In Process Cal	Standardizing to a sample of known chlorine concentration

A detailed flow diagram is provided at the end of Sec. 7 to guide you through the calibration routines.

To calibrate monochloramine:

1. Press the **MENU** button
2. Select **Calibrate**. Press ENTER.
3. Select **Sensor 1** or **Sensor 2** corresponding to Monochloramine. Press ENTER.
4. Select **Monochloramine**. Press ENTER.

The adjacent screen will appear. To calibrate Monochloramine or Temperature, scroll to the desired item and press ENTER.

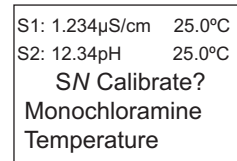

The following sub-sections provide you with the initial display screen that appears for each calibration routine. Use the **flow diagram for Chlorine calibration** at the end of Sec. 7 and the live screen prompts to complete calibration.

The adjacent screen appears after selecting Monochloramine calibration:

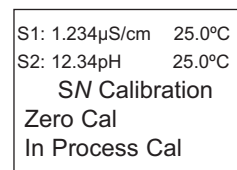

7.6.3.2 Zeroing The Sensor

The adjacent screen will appear during Zero Cal. Be sure sensor has been running in zero solution for at least two hours before starting zero step.

S1: 1.234µS/cm	25.0°C
S2: 12.34pH	25.0°C
SN Zero Cal	
Zeroing	
Wait	

The adjacent screen will appear if In Zero Cal is successful. The screen will return to the Amperometric Cal Menu.

S1: 1.234µS/cm	25.0°C
S2: 12.34pH	25.0°C
SN Zero Cal	
Sensor zero done	

The adjacent screen may appear if In Zero Cal is unsuccessful. The screen will return to the Amperometric Cal Menu.

S1: 1.234µS/cm	25.0°C
S2: 12.34pH	25.0°C
SN Zero Cal	
Sensor zero failed	
Press EXIT	

7.6.3.3 In Process Calibration

The adjacent screen will appear prior to In Process Cal

S1: 1.234µS/cm	25.0°C
S2: 12.34pH	25.0°C
SN InProcess Cal	
Wait for stable reading.	

If the In Process Cal is successful, the screen will return to the Cal sub-menu.

The adjacent screen may appear if In Process Cal is unsuccessful. The screen will return to the Amperometric Cal Menu.

S1: 1.234µS/cm	25.0°C
S2: 12.34pH	25.0°C
SN InProcess Cal	
Calibration	
Error	
Press EXIT	

7.6.4 pH-Independent Free Chlorine Measurement

7.6.4.1 Description

A free chlorine sensor generates a current directly proportional to the concentration of free chlorine in the sample. Calibrating the sensor requires exposing it to a solution containing no chlorine (zero standard) and to a solution containing a known amount of chlorine (full-scale standard). The zero calibration is necessary because chlorine sensors, even when no chlorine is in the sample, generate a small current called the residual current. The analyzer compensates for the residual current by subtracting it from the measured current before converting the result to a chlorine value. New sensors require zeroing before being placed in service, and sensors should be zeroed whenever the electrolyte solution is replaced. Either of the following makes a good zero standard:

- Deionized water.
- Tap water known to contain no chlorine. Expose tap water to bright sunlight for at least 24 hours.

The purpose of the In **Process calibration** is to establish the slope of the calibration curve. Because stable chlorine standards do not exist, **the sensor must be calibrated against a test run on a grab sample of the process liquid.**

Several manufacturers offer portable test kits for this purpose. Observe the following precautions when taking and testing the grab sample.

- Take the grab sample from a point as close to the sensor as possible. Be sure that taking the sample does not alter the flow of the sample to the sensor. It is best to install the sample tap just downstream from the sensor.
- Chlorine solutions are unstable. Run the test immediately after taking the sample. Try to calibrate the sensor when the chlorine concentration is at the upper end of the normal operating range.

Note: This measurement is made using the model 498CL-01 - pH-independent Free Chlorine sensor manufactured by Rosemount.

THIS SECTION DESCRIBES HOW TO CALIBRATE THE MODEL 1056 WITH AN ATTACHED PH-INDEPENDENT FREE CHLORINE SENSOR. THE FOLLOWING CALIBRATION ROUTINES ARE COVERED.

TABLE 7- 8 pH-independent Free Chlorine Calibration Routines

Measure	Sec.	Calibration function: default value	Description
pH-independent Free Chlorine	7.6.4.2	Zero Cal	Zeroing the sensor in solution with zero free chlorine
	7.6.4.3	In Process Cal	Standardizing to a sample of known chlorine concentration

A detailed flow diagram is provided at the end of Sec. 7 to guide you through the calibration routines.

To calibrate pH-independent free chlorine:

1. Press the **MENU** button
2. Select **Calibrate**. Press ENTER.
3. Select **Sensor 1** or **Sensor 2** corresponding to pH-independent free chlorine. Press ENTER.
4. Select **pH Ind. Free Cl**. Press ENTER.

S1: 1.234µS/cm	25.0°C
S2: 12.34pH	25.0°C
SN Calibrate?	
pH Ind. Free Cl	
Temperature	

The adjacent screen will appear. To calibrate pH-independent Free Chlorine or Temperature, scroll to the desired item and press ENTER.

The following sub-sections provide you with the initial display screen that appears for each calibration routine. Use the **flow diagram for Chlorine calibration** at the end of Sec. 7 and the live screen prompts to complete calibration.

The adjacent screen appears after selecting **pH-independent free chlorine calibration**:

```
S1: 1.234µS/cm  25.0°C
S2: 12.34pH    25.0°C
SN Calibration
Zero Cal
In Process Cal
```

7.6.4.2 Zeroing The Sensor

The adjacent screen will appear during Zero Cal

```
S1: 1.234µS/cm  25.0°C
S2: 12.34pH    25.0°C
SN Zero Cal
Zeroing
Wait
```

The adjacent screen will appear if In Zero Cal is successful. The screen will return to the Amperometric Cal Menu.

```
S1: 1.234µS/cm  25.0°C
S2: 12.34pH    25.0°C
SN Zero Cal
Sensor zero done
```

The adjacent screen may appear if In Zero Cal is unsuccessful. The screen will return to the Amperometric Cal Menu.

```
S1: 1.234µS/cm  25.0°C
S2: 12.34pH    25.0°C
SN Zero Cal
Sensor zero failed

Press EXIT
```

7.6.4.3 In Process Calibration

The following screen will appear prior to In Process Cal

```
S1: 1.234µS/cm  25.0°C
S2: 12.34pH    25.0°C
SN InProcess Cal
Wait for stable
reading.
```

If the In Process Cal is successful, the screen will return to the Cal sub-menu.

The adjacent screen may appear if In Process Cal is unsuccessful. The screen will return to the Amperometric Cal Menu.

```
S1: 1.234µS/cm  25.0°C
S2: 12.34pH    25.0°C
SN InProcess Cal
Calibration
Error

Press EXIT
```

7.7 Calibration — Oxygen

7.7.1 Description

Oxygen sensors generate a current directly proportional to the concentration of dissolved oxygen in the sample. Calibrating the sensor requires exposing it to a solution containing no oxygen (zero standard) and to a solution containing a known amount of oxygen (full-scale standard). The **Zero Calibration** is necessary because oxygen sensors, even when no oxygen is present in the sample, generate a small current called the residual current. The analyzer compensates for the residual current by subtracting it from the measured current before converting the result to a dissolved oxygen value. New sensors require zeroing before being placed in service, and sensors should be zeroed whenever the electrolyte solution is replaced. The recommended zero standard is 5% sodium sulfite in water, although oxygen-free nitrogen can also be used. **The Model 499A TrDO sensor, used for the determination of trace (ppb) oxygen levels, has very low residual current and does not normally require zeroing.** The residual current in the 499A TrDO sensor is equivalent to less than 0.5 ppb oxygen.

The purpose of the **In Process Calibration** is to establish the slope of the calibration curve. Because the solubility of atmospheric oxygen in water as a function of temperature and barometric pressure is well known, the natural choice for a full-scale standard is air-saturated water. However, air-saturated water is difficult to prepare and use, so the universal practice is to use air for calibration. From the point of view of the oxygen sensor, air and air-saturated water are identical. The equivalence comes about because the sensor really measures the chemical potential of oxygen. Chemical potential is the force that causes oxygen molecules to diffuse from the sample into the sensor where they can be measured. It is also the force that causes oxygen molecules in air to dissolve in water and to continue to dissolve until the water is saturated with oxygen. Once the water is saturated, the chemical potential of oxygen in the two phases (air and water) is the same.

Oxygen sensors generate a current directly proportional to the rate at which oxygen molecules diffuse through a membrane stretched over the end of the sensor. The

diffusion rate depends on the difference in chemical potential between oxygen in the sensor and oxygen in the sample. An electrochemical reaction, which destroys any oxygen molecules entering the sensor, keeps the concentration (and the chemical potential) of oxygen inside the sensor equal to zero. Therefore, the chemical potential of oxygen in the sample alone determines the diffusion rate and the sensor current.

When the sensor is calibrated, the chemical potential of oxygen in the standard determines the sensor current. Whether the sensor is calibrated in air or air-saturated water is immaterial. The chemical potential of oxygen is the same in either phase. Normally, to make the calculation of solubility in common units (like ppm DO) simpler, it is convenient to use water-saturated air for calibration. Automatic air calibration is standard. The user simply exposes the sensor to water-saturated air. The analyzer monitors the sensor current. When the current is stable, the analyzer stores the current and measures the temperature using a temperature element inside the oxygen sensor. The user must enter the barometric pressure.

From the temperature the analyzer calculates the saturation vapor pressure of water. Next, it calculates the pressure of dry air by subtracting the vapor pressure from the barometric pressure. Using the fact that dry air always contains 20.95% oxygen, the analyzer calculates the partial pressure of oxygen. Once the analyzer knows the partial pressure of oxygen, it uses the Bunsen coefficient to calculate the equilibrium solubility of atmospheric oxygen in water at the prevailing temperature. At 25°C and 760 mm Hg, the equilibrium solubility is 8.24 ppm. Often it is too difficult or messy to remove the sensor from the process liquid for calibration. In this case, the sensor can be calibrated against a measurement made with a portable laboratory instrument. The laboratory instrument typically uses a membrane-covered amperometric sensor that has been calibrated against water-saturated air.

THIS SECTION DESCRIBES HOW TO CALIBRATE THE MODEL 1056 WITH AN OXYGEN SENSOR. THE FOLLOWING CALIBRATION ROUTINES ARE COVERED.

TABLE 7- 9 Oxygen Calibration Routines

Measure	Sec.	Calibration function: default value	Description
Oxygen	7.7.2	Zero Cal	Zeroing the sensor in a medium with zero oxygen
	7.7.3	Air Cal	Calibrating the sensor in a water-saturated air sample
	7.7.4	In Process Cal	Standardizing to a sample of known oxygen concentration
	7.7.5	Sen@ 25°C:2500nA/ppm	Entering a known slope value for sensor response
	7.7.6	Zero Current: 0nA	Entering a known zero current for a specific sensor

A detailed flow diagram is provided at the end of Sec. 7 to guide you through the calibration routines.

Oxygen sensors generate a current directly proportional to the concentration of dissolved oxygen in the sample. Calibrating the sensor requires exposing it to a solution containing no oxygen (zero standard) and to a solution containing a known amount of oxygen (full-scale standard). Automatic air calibration is standard. The user simply exposes the sensor to water-saturated air.

To calibrate oxygen:

1. Press the **MENU** button
2. Select **Calibrate**. Press ENTER.
3. Select **Sensor 1** or **Sensor 2** corresponding to oxygen. Press ENTER.
4. Select **Oxygen**. Press ENTER.

The adjacent screen will appear. To calibrate Oxygen or Temperature, scroll to the desired item and press ENTER

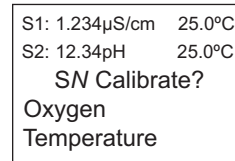

The following sub-sections provide you with the initial display screen that appears for each calibration routine. Use the **flow diagram for Oxygen calibration** at the end of Sec. 7 and the live screen prompts for each routine to complete calibration.

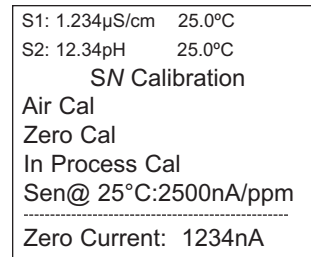

The adjacent screen appears after selecting **Oxygen calibration**:

Air calibration criteria can be changed. The following criteria can be adjusted:

- Stabilization time (default 10 sec.)
- Stabilization pH value (default 0.05 ppm)
- Salinity of the solution to be measured (default 00.0 parts per thousand)

The adjacent screen will appear to allow adjustment of these criteria”

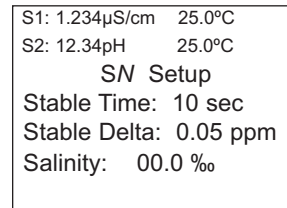

7.7.2 Zeroing The Sensor

The adjacent screen will appear during Zero Cal

```
S1: 1.234 nA
S2: 1.456 nA
SN Zero Cal
Zeroing
Wait
```

The adjacent screen will appear if In Zero Cal is successful. The screen will return to the Amperometric Cal Menu.

```
S1: 1.234 nA
S2: 1.456 nA
SN Zero Cal
Sensor zero done
```

The adjacent screen may appear if In Zero Cal is unsuccessful. The screen will return to the Amperometric Cal Menu.

```
S1: 1.234 nA
S2: 1.456 nA
SN Zero Cal
Sensor zero failed

Press EXIT
```

7.7.3 Calibrating The Sensor In Air

The adjacent screen will appear prior to Air Cal

```
S1: 1.234µS/cm 25.0°C
S2: 12.34pH 25.0°C
SN Air Cal
Start Calibration
Setup
```

The adjacent screen will appear if In Air Cal is successful. The screen will return to the Amperometric Cal Menu.

```
S1: 1.234µS/cm 25.0°C
S2: 12.34pH 25.0°C
SN Air Cal
Done
```

The adjacent screen will appear if In Air Cal is unsuccessful. The screen will return to the Amperometric Cal Menu.

```
S1: 1.234µS/cm 25.0°C
S2: 12.34pH 25.0°C
SN Air Cal
Failure
Check Sensor

Press EXIT
```

7.7.4 Calibrating The Sensor Against A Standard Instrument (In Process Cal)

The adjacent screen will appear prior to In Process Cal

```
S1: 1.234µS/cm 25.0°C
S2: 12.34pH 25.0°C
SN InProcess Cal
Wait for stable
reading.
```

If the In Process Cal is successful, the screen will return to the Cal sub-menu.

```
S1: 1.234µS/cm 25.0°C
S2: 12.34pH 25.0°C
SN InProcess Cal
Calibration
Error

Press EXIT
```

The adjacent screen may appear if In Zero Cal is unsuccessful. The screen will return to the Amperometric Cal Menu.

7.8 Calibration — Ozone

7.8.1 Description

An ozone sensor generates a current directly proportional to the concentration of ozone in the sample. Calibrating the sensor requires exposing it to a solution containing no ozone (zero standard) and to a solution containing a known amount of ozone (full-scale standard). The Zero Calibration is necessary because ozone sensors, even when no ozone is in the sample, generate a small current called the residual or zero current. The analyzer compensates for the residual current by subtracting it from the measured current before converting the result to an ozone value. New sensors require zeroing before being placed in service, and sensors should be zeroed whenever the electrolyte solution is replaced. The best zero standard is deionized water.

The purpose of the In Process Calibration is to establish the slope of the calibration curve. Because stable ozone standards do not exist, the sensor must be calibrated

against a test run on a grab sample of the process liquid. Several manufacturers offer portable test kits for this purpose. Observe the following precautions when taking and testing the grab sample.

- Take the grab sample from a point as close to the sensor as possible. Be sure that taking the sample does not alter the flow of the sample to the sensor. It is best to install the sample tap just downstream from the sensor.
- Ozone solutions are unstable. Run the test immediately after taking the sample. Try to calibrate the sensor when the ozone concentration is at the upper end of the normal operating range.

THIS SECTION DESCRIBES HOW TO CALIBRATE THE MODEL 1056 WITH AN OZONE SENSOR. THE FOLLOWING CALIBRATION ROUTINES ARE COVERED.

TABLE 7- 10 Ozone Calibration Routines

Measure Ozone	Sec.	Calibration function: default value	Description
	7.8.2	Zero Cal	Zeroing the sensor in solution with zero ozone
	7.8.3	In Process Cal	Standardizing to a sample of known ozone concentration

A detailed flow diagram is provided at the end of Sec. 7 to guide you through the calibration routines.

To calibrate ozone:

1. Press the **MENU** button
2. Select **Calibrate**. Press ENTER.
3. Select **Sensor 1** or **Sensor 2** corresponding to ozone. Press ENTER.
4. Select **Ozone**. Press ENTER.

The adjacent screen will appear. To calibrate Ozone or Temperature, scroll to the desired item and press ENTER.

S1: 1.234µS/cm	25.0°C
S2: 12.34pH	25.0°C
SN Calibrate?	
Ozone	
Temperature	

The following sub-sections provide you with the initial display screen that appears for each calibration routine. Use the **flow diagram for Ozone calibration** at the end of Sec. 7 and the live screen prompts to complete calibration.

The adjacent screen appears after selecting Ozone calibration:

```
S1: 1.234µS/cm  25.0°C
S2: 12.34pH    25.0°C
  SN Calibration
  Zero Cal
  In Process Cal
```

7.8.2 Zeroing The Sensor

The following screen will appear during Zero Cal

```
S1:          1.234 nA
S2:          1.456 nA
  SN Zero Cal
  Zeroing
  Wait
```

The following screen will appear if In Zero Cal is successful. The screen will return to the Amperometric Cal Menu.

```
S1:          1.234 nA
S2:          1.456 nA
  SN Zero Cal
  Sensor zero done
```

The following screen may appear if In Zero Cal is unsuccessful. The screen will return to the Amperometric Cal Menu.

```
S1:          1.234 nA
S2:          1.456 nA
  SN Zero Cal
  Sensor zero failed

  Press EXIT
```

7.8.3 In Process Calibration

The following screen will appear after selecting In Process Cal

```
S1: 1.234µS/cm  25.0°C
S2: 12.34pH    25.0°C
  SN InProcess Cal
  Wait for stable
  reading.
```

If the In Process Cal is successful, the screen will return to the Cal sub-menu.

The following screen may appear if In Zero Cal is unsuccessful. The screen will return to the Amperometric Cal Menu.

```
S1: 1.234µS/cm  25.0°C
S2: 12.34pH    25.0°C
  SN InProcess Cal
  Calibration
  Error

  Press EXIT
```

7.9 Calibrating Temperature

7.9.1 Description

Most liquid analytical measurements require temperature compensation (except ORP). The Model 1056 performs temperature compensation automatically by applying internal temperature correction algorithms. Temperature correction can also be turned off. If temperature correction is off, the Model 1056 uses the manual temperature entered by the user in all temperature correction calculations.

THIS SECTION DESCRIBES HOW TO CALIBRATE TEMPERATURE IN THE MODEL 1056 ANALYZER. THE FOLLOWING CALIBRATION ROUTINE IS COVERED.

TABLE 7- 11 Temperature Calibration Routine

Measure	Sec.	Calibration function: default value	Description
Temperature	7.9.2	Calibrate	Enter a manual reference temperature for temperature compensation of the process measurement

A detailed flow diagram is provided at the end of Sec. 7 to guide you through the calibration routines.

To calibrate temperature:

1. Press the **MENU** button
2. Select **Calibrate**. Press ENTER.
3. Select **Sensor 1** or **Sensor 2** corresponding to the desired measurement. Press ENTER.
4. Select **Temperature**. Press ENTER.

S1: 1.234μS/cm	25.0°C
S2: 12.34pH	25.0°C
SN Calibrate	
+025.0°C	

The adjacent screen will appear.

The following sub-section provides you with the initial display screen that appears for temperature calibration. Use the **flow diagram for Temp calibration** at the end of Sec. 7 to complete calibration.

S1: 1.234μS/cm	25.0°C
S2: 12.34pH	25.0°C
SN Calibrate	
Cal in progress.	
Please wait.	

7.9.2 Calibration

The adjacent screen will appear during Temperature Cal.

If the sensor Temperature offset is greater than 5 °C from the default value, the following screen will appear:

You may continue by selecting Yes or suspend this operation by selecting No.

S1: 1.234μS/cm	25.0°C
S2: 12.34pH	25.0°C
SN Temp Offset > 5°C	
Continue?	
No	
Yes	

If the Temp Cal is successful, the screen will return to the Cal Menu.

Note: To select automatic or manual temp compensation or to program temperature units as °C or °F, refer to Sec. 5.3 – Programming Temperature in this manual

7.10 Turbidity

7.10.1 Description

This section describes how to calibrate the turbidity sensor against a user-prepared standard as a 2-point calibration with di-ionized water, against a 20 NTU user-prepared standard as a single point calibration, and against a grab sample using a reference turbidimeter.

THIS SECTION DESCRIBES HOW TO CALIBRATE THE MODEL 1056 WITH AN ATTACHED TURBIDITY SENSOR AS PART OF THE COMPLETE CLARITY II TURBIDITY SYSTEM. THE FOLLOWING CALIBRATION ROUTINES ARE COVERED.

Table 7-12 Turbidity Calibration Routines

Measure	Sec.	Calibration function:	default value	Description
Turbidity	7.10.2	Slope Calibration		Slope cal with pure water and a standard of known turbidity
	7.10.3	Standardize Calibration		Standardizing the sensor to a known turbidity
	7.10.4	Grab Calibration		Standardizing the sensor to a known turbidity based on a reference turbidimeter

A detailed flow diagram is provided at the end of Sec. 7 to guide you through the calibration routines.

To calibrate Turbidity:

1. Press the **MENU** button
2. Select **Calibrate**. Press ENTER.
3. Select **Sensor 1** or **Sensor 2** corresponding to Turbidity. Press ENTER.
4. Select **Turbidity**. Press ENTER.

The following screen will appear.

```
S1: 1.234µS/cm  25.0°C
S2: 12.34pH    25.0°C
      SN Calibrate?
      Turbidity
```

The following sub-sections provide you with the initial display screen that appears for each calibration routine. Use the **flow diagram for Turbidity calibration** at the end of Sec. 7 and the live screen prompts to complete calibration.

```
S1: 1.234µS/cm  25.0°C
S2: 12.34pH    25.0°C
      SN Calibrate
      Slope
      Standard
      Grab
```

7.10.2 SLOPE CALIBRATION — Turbidity

This section describes how to conduct a 2-point calibration of the turbidity sensor against a user-prepared 20NTU standard. The calibration requires two steps. First, immerse the sensor in filtered water having very low turbidity and measure the sensor output. Next, increase the turbidity of the filtered water by a known amount, typically 20 NTU, and measure the sensor output again. The analyzer takes the two measurements, applies a linearization correction (if necessary), and calculates the sensitivity. Sensitivity is the sensor output (in mV) divided by turbidity. A typical new sensor has a sensitivity of about 10 mV/NTU. As the sensor ages, the sensitivity decreases. The figure below illustrates how turbidity calibration works. Before beginning the calibration, the analyzer does a dark current measurement. Dark current is the signal generated by the detector when no light is falling on it. The analyzer subtracts the dark current from the raw scat-

tered light signal and converts the result to turbidity. In highly filtered samples, which scatter little light, the dark current can be a substantial amount of the signal generated by the detector.

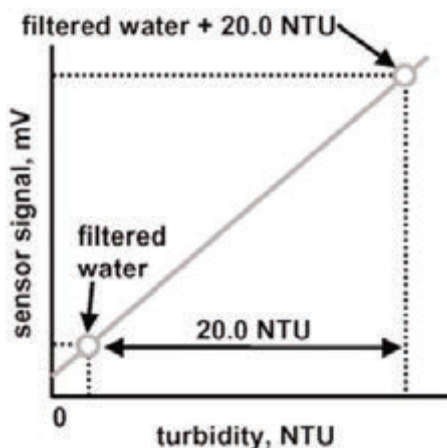

This screen appears after selecting Slope calibration.

```
S1: 1.234µS/cm  25.0°C  
S2: 12.34pH    25.0°C  
          SN Slope Cal  
Sensor in pure H2O?  
Press ENTER
```

The following screen will appear if Slope Cal is successful. The screen will return to the Turbidity Cal Menu.

```
S1: 1.234µS/cm  25.0°C  
S2: 12.34pH    25.0°C  
          SN Slope Cal  
Cal Complete
```

The following screen may appear if Slope Cal is unsuccessful.

```
S1: 1.234µS/cm  25.0°C  
S2: 12.34pH    25.0°C  
          SN Slope Cal  
Calibration  
Error  
  
Press EXIT
```

7.10.3 Standardize Calibration - Turbidity

The turbidity sensor can also be calibrated against a commercial standard. Stable 20.0 NTU standards are available from a number of sources. Calibration using a commercial standard is simple. Filtered deionized water is not required. Before beginning the calibration, the analyzer does a dark current measurement. Dark current is the signal generated by the detector even when no light is falling on it. The analyzer subtracts the dark current from the raw scattered light signal and converts the result to turbidity. In highly filtered samples, which scatter little light, the dark current can be a substantial amount of the signal generated by the sensor.

The following screen will appear if Standard Cal is successful. The screen will return to the Turbidity Cal Menu.

This screen appears after selecting **Standard calibration**.

```
S1: 1.234µS/cm  25.0°C  
S2: 12.34pH    25.0°C  
          SN Standard Cal  
Sensor in Standard?  
Press ENTER
```

```
S1: 1.234µS/cm  25.0°C  
S2: 12.34pH    25.0°C  
          SN Standard Cal  
Cal Complete
```

The following screen may appear if Standard Cal is unsuccessful.

```
S1: 1.234µS/cm  25.0°C  
S2: 12.34pH    25.0°C  
          SN Standard Cal  
Calibration  
Error  
  
Press EXIT
```

7.10.4 Grab Calibration - Turbidity

If desired, the turbidity sensor can be calibrated against the turbidity reading from another instrument. The analyzer treats the value entered by the user as though it were the true turbidity of the sample. Therefore, grab sample calibration changes the sensitivity, it does not apply an offset to the reading.

This screen appears after selecting **Grab calibration**.

```
S1: 1.234µS/cm  25.0°C
S2: 12.34pH    25.0°C
                SN Grab Cal
Wait for stable
reading
```

The following screen will appear if Grab Cal is successful. The screen will return to the Turbidity Cal Menu.

```
S1: 1.234µS/cm  25.0°C
S2: 12.34pH    25.0°C
                SN Grab Cal
Cal Complete
```

The following screen may appear if Grab Cal is unsuccessful.

```
S1: 1.234µS/cm  25.0°C
S2: 12.34pH    25.0°C
                SN Grab Cal
Calibration
Error

Press EXIT
```

7.11 Pulse Flow

7.11.1 Description

A variety of pulse flow sensors can be wired to the Flow signal input board to measure flow volume, total volume and flow difference (if 2 Flow signal boards are installed). The Model 1056 Flow signal board will support flow sensors that are self-driven (powered by the rotation of the impeller paddle-wheel).

THIS SECTION DESCRIBES HOW TO CALIBRATE THE MODEL 1056 WITH AN ATTACHED FLOW SENSOR. THE FOLLOWING CALIBRATION ROUTINES ARE COVERED.

TABLE 7-13 Flow Calibration Routines

Measure	Sec.	Calibration function	Description
Pulse Flow	7.11.2	K Factor	A constant value representing pulses/Gal of flow
	7.11.3	Frequency/Velocity & Pipe	Alternate cal method – requires manual entry of frequency (Hz) per velocity and Pipe diameter used
	7.11.4	In process Calibration	Calibration based on known volume per unit of time
	7.11.5	Totalizer Control	User settings to stop, restart and reset total volume meter

A detailed flow diagram is provided at the end of Sec. 7 to guide you through the calibration routines.

To calibrate Pulse Flow:

1. Press the **MENU** button
2. Select **Calibrate**. Press ENTER.
3. Select **Sensor 1** or **Sensor 2** corresponding to Flow. Press ENTER.
4. Select **Pulse Flow**. Press ENTER.

```
S1: 1.234µS/cm  25.0°C
S2: 12.34pH    25.0°C
                SN Calibrate?
Pulse Flow
```

The following screen will appear.

To calibrate Pulse Flow scroll to the desired item and press ENTER.

The following sub-sections provide you with the initial display screen that appears for each calibration routine. Use the **diagram for Pulse Flow calibration** at the end of Sec. 7 and the live screen prompts to complete calibration.

7.11.2 Calibration — K Factor

This screen appears after selecting **K Factor**.

```
S1: 1.234µS/cm  25.0°C
S2: 12.34pH    25.0°C
SN Calibration
K Factor: 12.34 p/Gal
Freq/Velocity & Pipe
In Process
Totalizer Control
```

```
S1: 1.234µS/cm  25.0°C
S2: 12.34pH    25.0°C
SN K Factor
12.34 p/Gal
```

To calibrate Pulse Flow scroll to the desired item and press ENTER.

The following sub-sections provide you with the initial display screen that appears for each calibration routine. Use the **diagram for Pulse Flow calibration** at the end of Sec. 7 and the live screen prompts to complete calibration.

```
S1: 1.234µS/cm  25.0°C
S2: 12.34pH    25.0°C
SN Calibration
K Factor: 12.34 p/Gal
Freq/Velocity & Pipe
In Process
Totalizer Control
```

Simply enter the know K factor provided with the flow sensor specifications. The screen will return to the Pulse Flow Cal Menu and the updated K factor will appear.

7.11.3 Calibration — Freq/Velocity and Pipe

This screen appears after selecting **Freq/Velocity & Pipe calibration**.

```
S1: 1.234µS/cm  25.0°C
S2: 12.34pH    25.0°C
SN Freq/Velocity
12.34 Hz per ft/sec
```

After completing the entry of the Freq/Velocity ratio, the following screen will appear:

```
S1: 1.234µS/cm  25.0°C
S2: 12.34pH    25.0°C
SN Pipe Diameter
10.00 in
```

The following screen will appear if the entries are successful. The screen will return to the Pulse Flow Cal Menu.

```
S1: 1.234µS/cm  25.0°C
S2: 12.34pH    25.0°C
SN Freq/Velocity&Pipe
Updated K Factor
12.34 p/Gal
```

The following screen may appear if the entries are unsuccessful.

```
S1: 1.234µS/cm  25.0°C
S2: 12.34pH    25.0°C
SN Freq/Velocity&Pipe
Calibration
Error

Press EXIT
```

7.11.4 Calibration — In Process Cal

This screen appears after selecting **In Process Cal**.

The following screen will appear if the entries are successful. The screen will return to the Pulse Flow Cal Menu.

```
S1: 1.234µS/cm  25.0°C
S2: 12.34pH    25.0°C
SN InProcess Cal
Updated K Factor
12.34 p/Gal
```

The following screen will appear if the entries are successful.

```
S1: 1.234µS/cm  25.0°C
S2: 12.34pH    25.0°C
SN InProcess Cal
Calibration
Error

Press EXIT
```

7.11.5 Calibration — Totalizer Control

This screen appears after selecting **Totalizer Control**.

```
S1: 1.234µS/cm  25.0°C
S2: 12.34pH    25.0°C
SN Totalizer Control
Stop
Resume
Reset
123456789012.3 G
```

The user can suspend the totalizer by selecting Stop, re-enable the totalizer by selecting Resume and return the totalizer volume count to zero by selecting Reset. The live totalizer volume count is displayed during these menu operations.

FIGURE 7-1 Calibrate pH

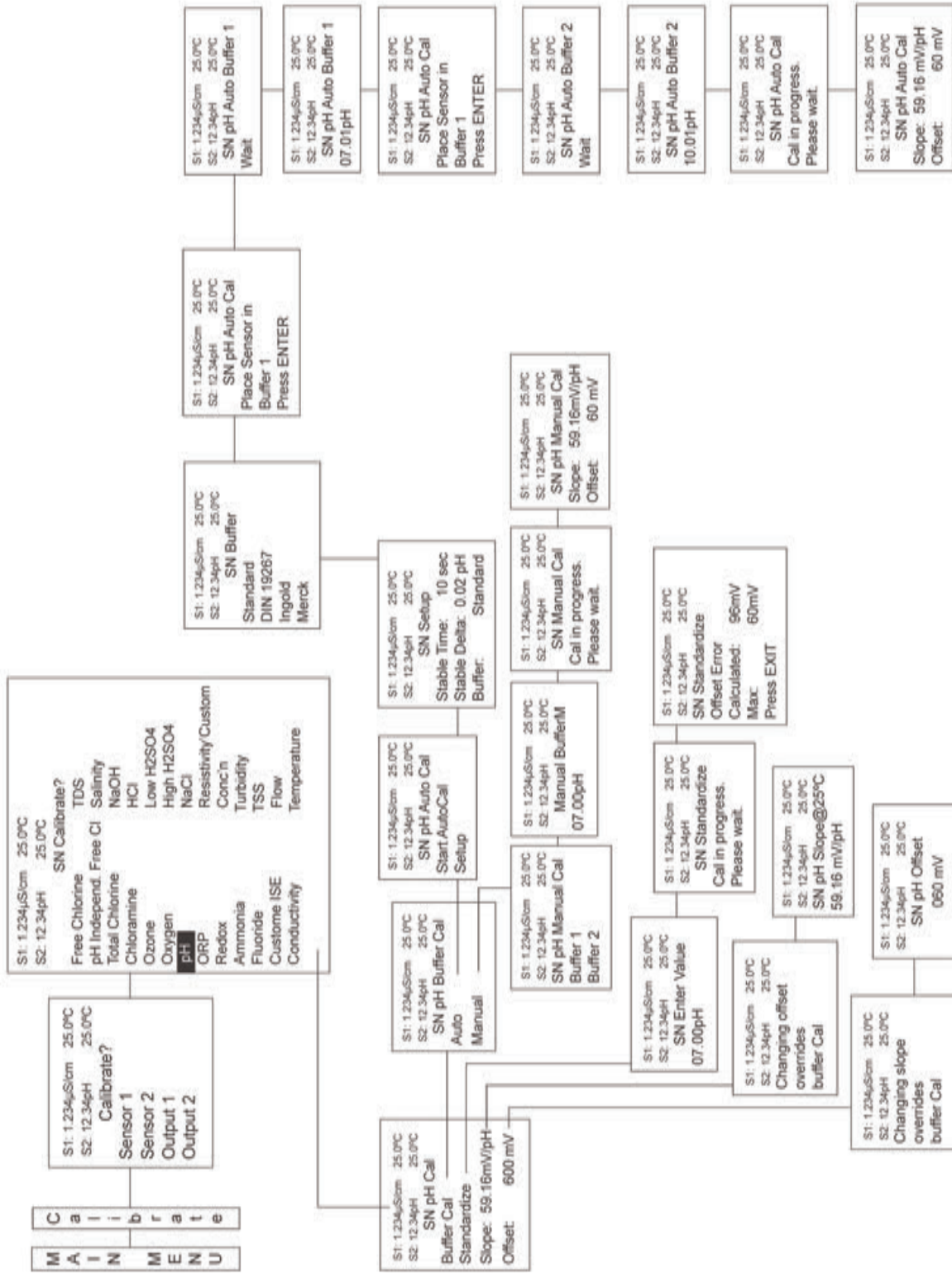

FIGURE 7-2 Calibrate ORP

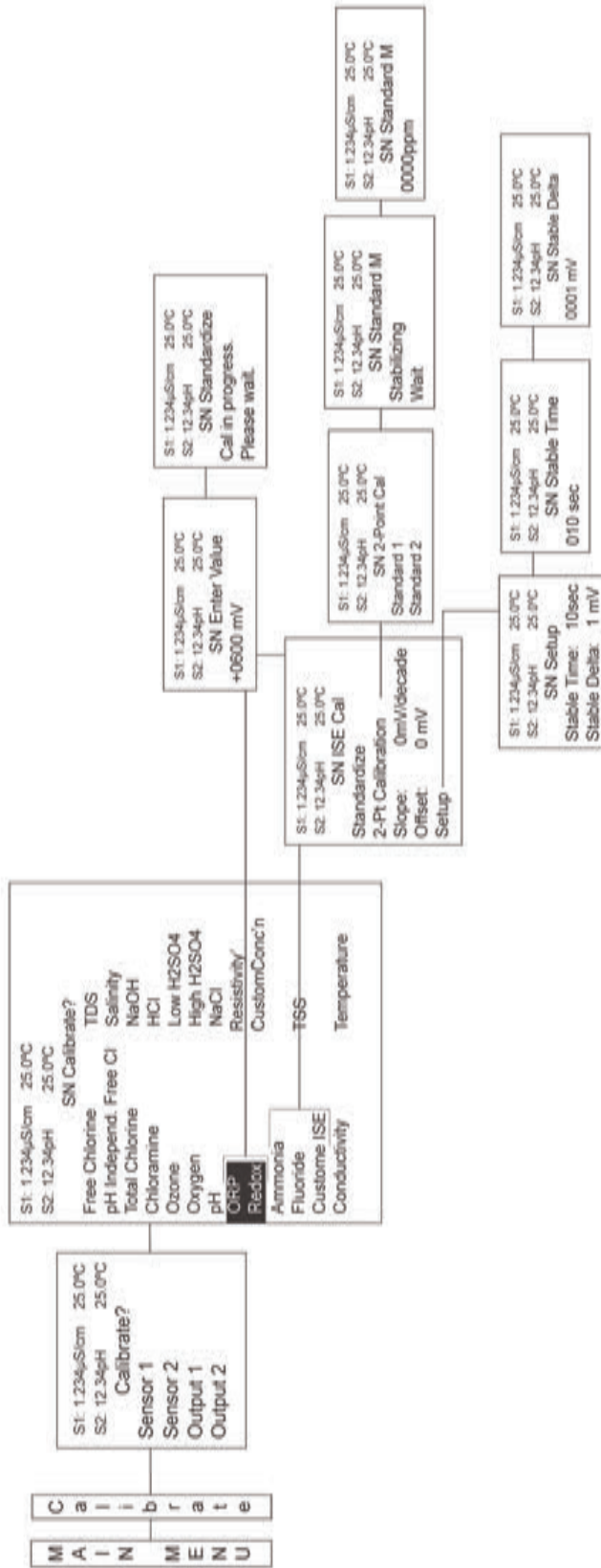

FIGURE 7-3 Calibrate Contacting and Toroidal Conductivity

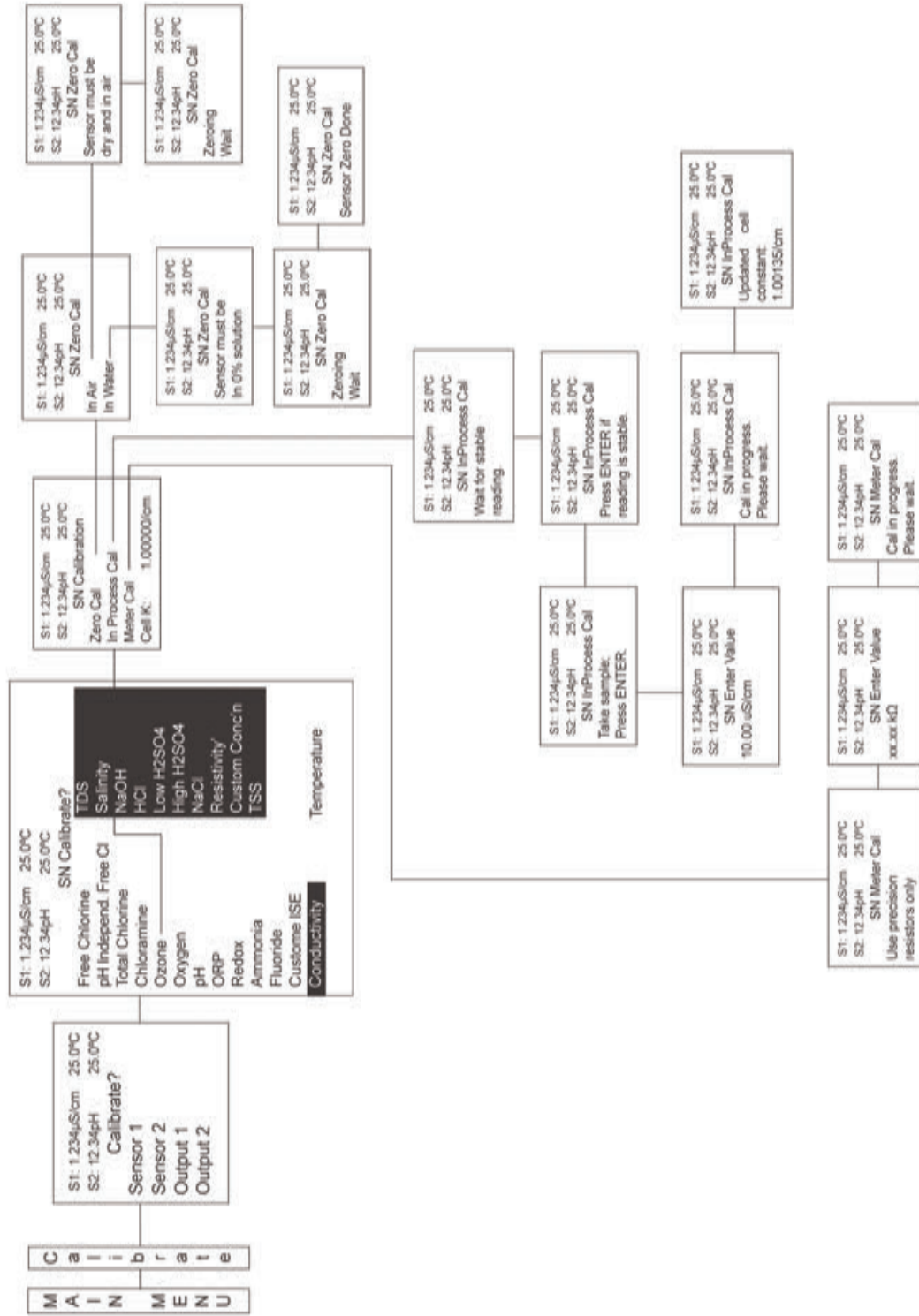

FIGURE 7-4 Calibrate Free Chlorine, Total Chlorine, Monochloramine, and pH-independent Free Chlorine

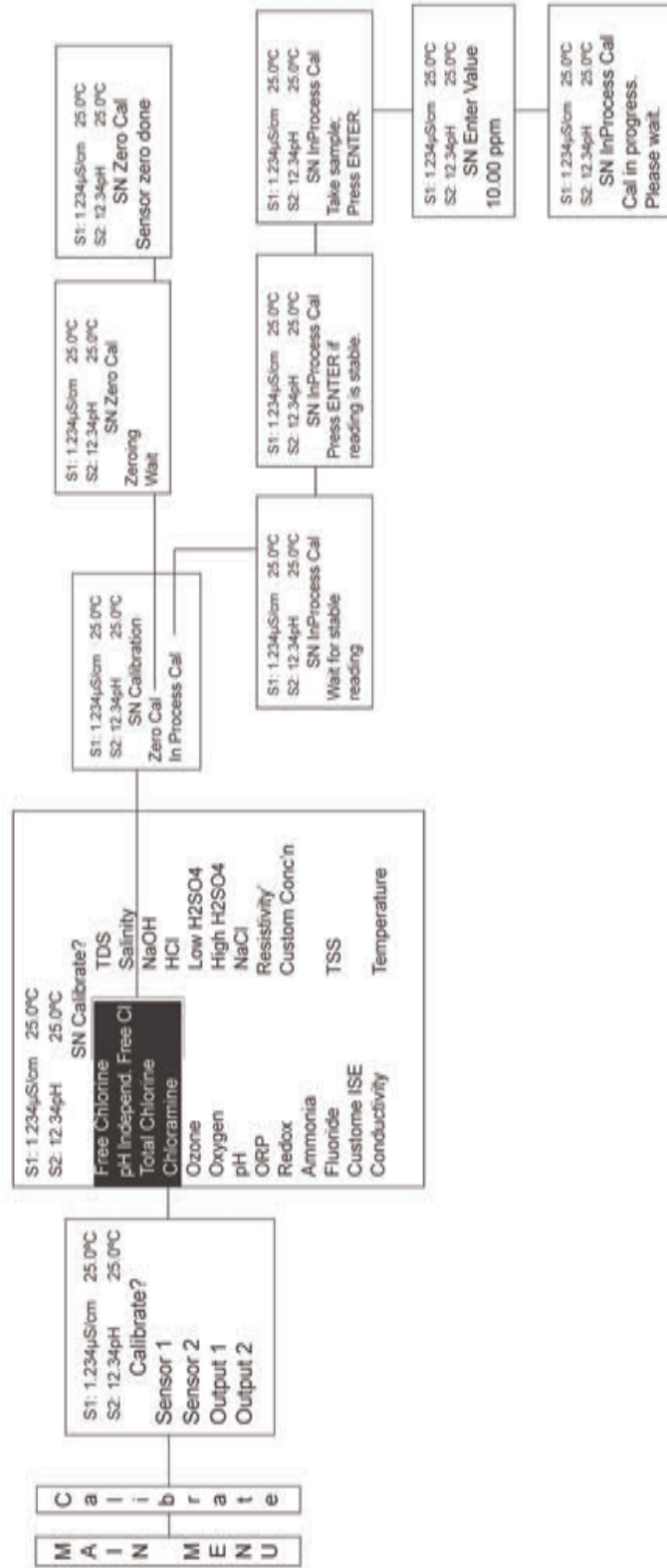

FIGURE 7-5 Calibrate Oxygen

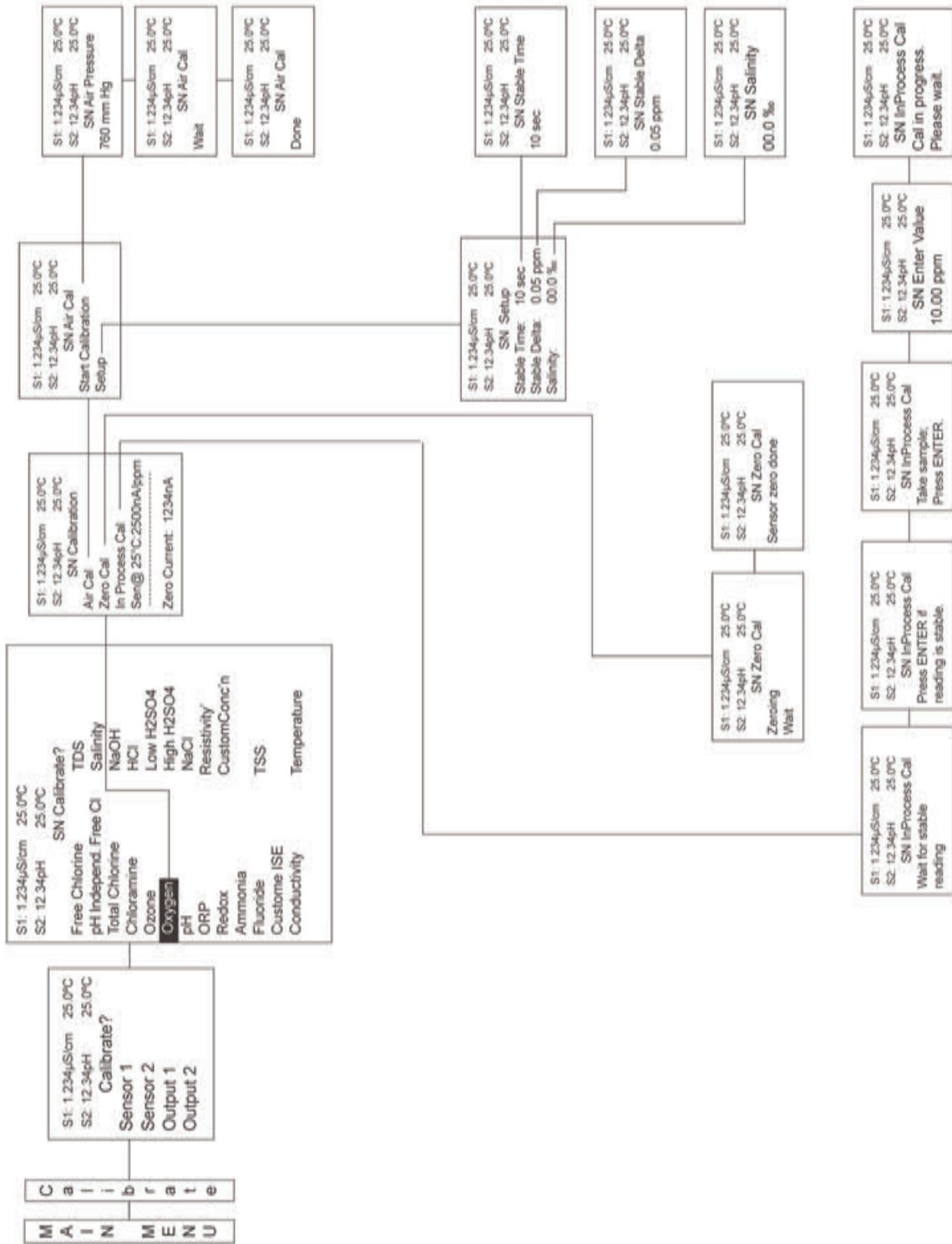

FIGURE 7-6 Calibrate Ozone

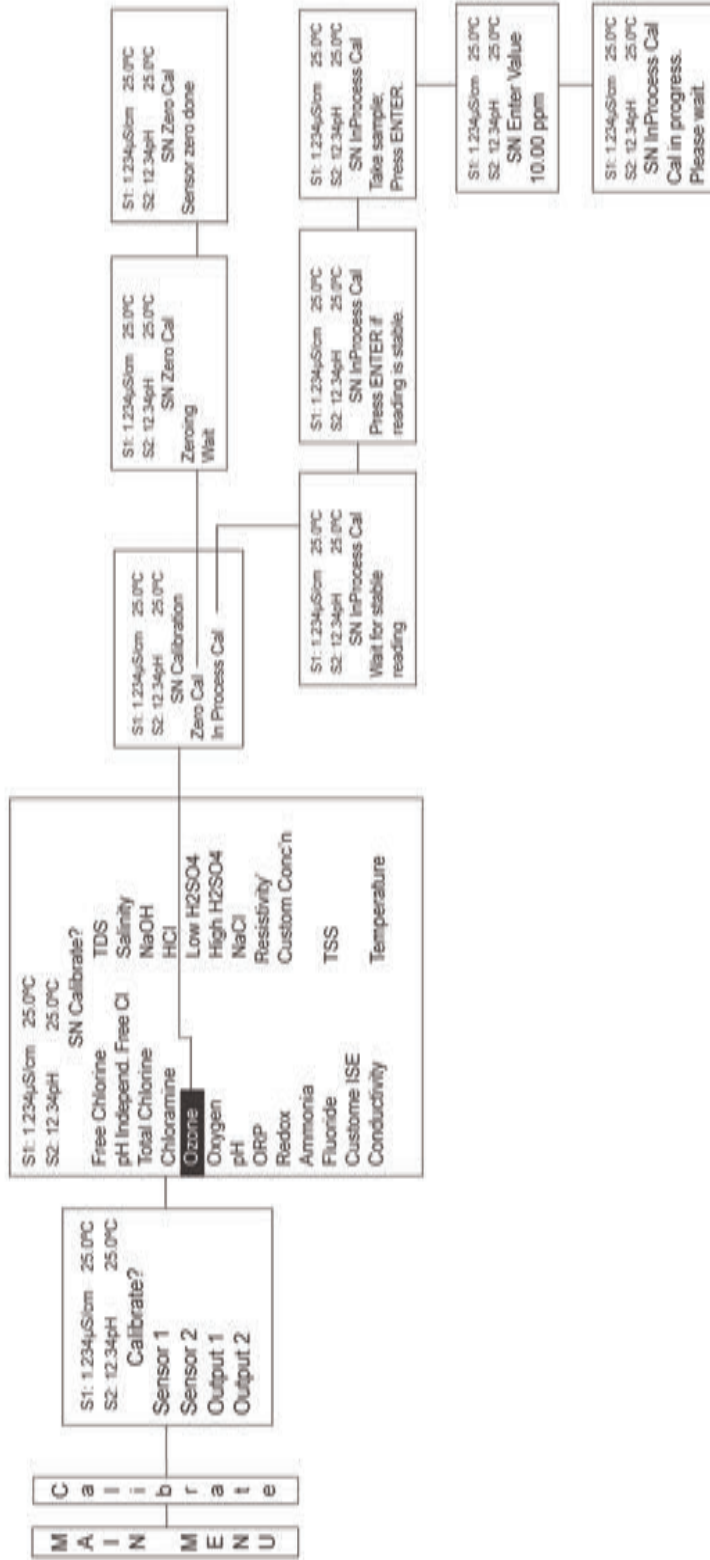

FIGURE 7-7 Calibrate Temperature

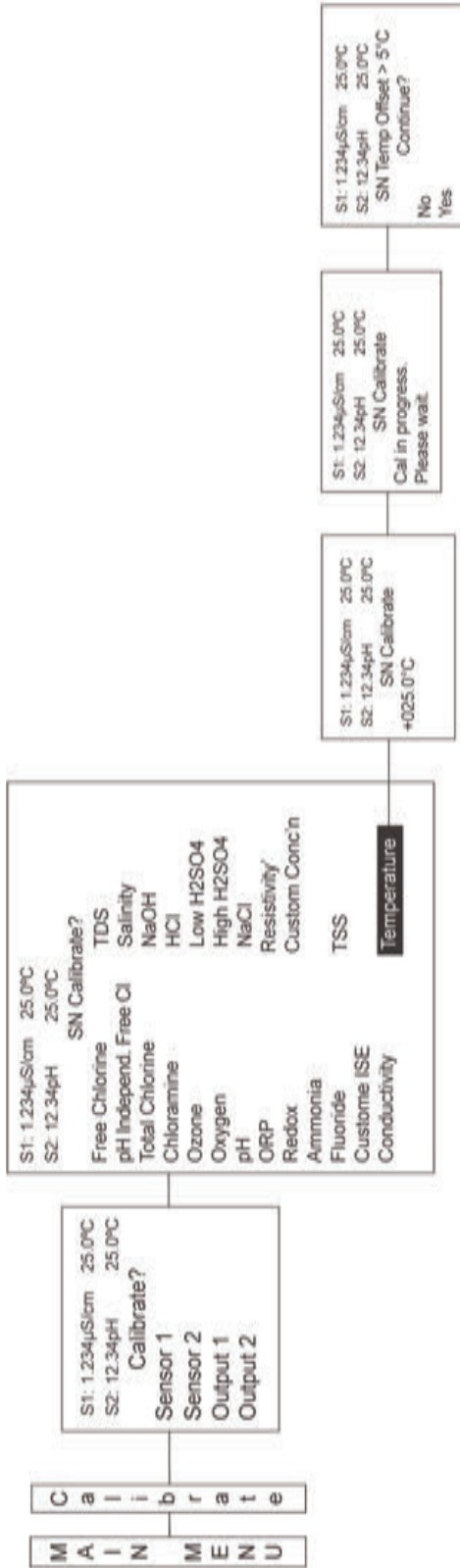
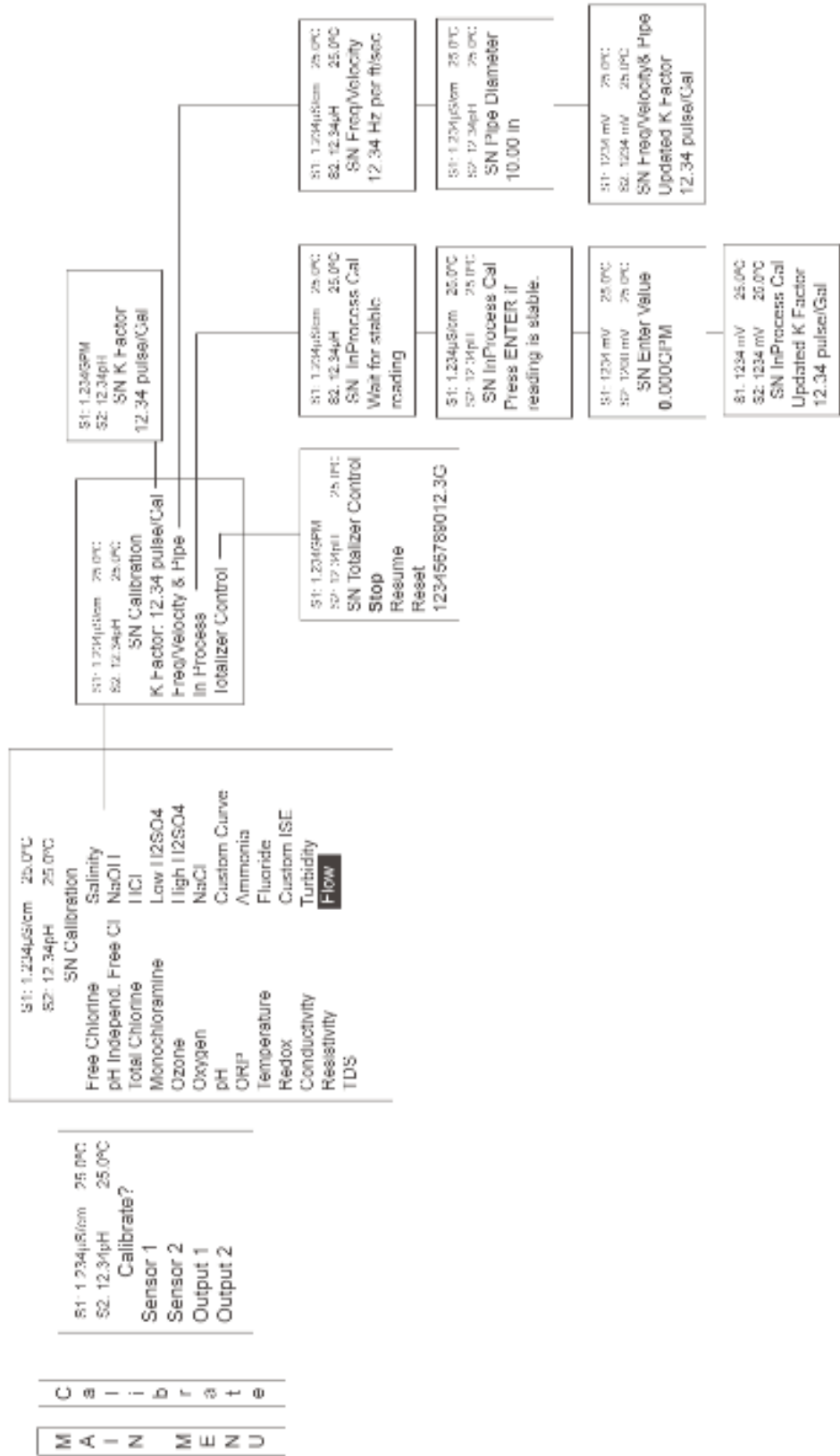

FIGURE 7-8 Calibrate Turbidity



FIGURE 7-9 Calibrate Flow



Section 8.0 Return of Material

8.1 General

To expedite the repair and return of instruments, proper communication between the customer and the factory is important. Before returning a product for repair, call 1-949-757-8500 for a Return Materials Authorization (RMA) number.

8.2 Warranty Repair

The following is the procedure for returning instruments still under warranty:

1. Call Emerson for authorization.
2. To verify warranty, supply the factory sales order number or the original purchase order number. In the case of individual parts or sub-assemblies, the serial number on the unit must be supplied.
3. Carefully package the materials and enclose your "Letter of Transmittal" (see Warranty). If possible, pack the materials in the same manner as they were received.
4. Send the package prepaid to:

Emerson
8200 Market Blvd.
Chanhassen, MN 55317

Attn: Factory Repair

RMA No. _____

Mark the package: Returned for Repair

Model No. _____

IMPORTANT

Please see second section of "Return of Materials Request" form. Compliance with the OSHA requirements is mandatory for the safety of all personnel. MSDS forms and a certification that the instruments have been disinfected or detoxified are required.

8.3 Non-Warranty Repair



The following is the procedure for returning for repair instruments that are no longer under warranty:

1. Call Emerson for authorization.
2. Supply the purchase order number, and make sure to provide the name and telephone number of the individual to be contacted should additional information be needed.
3. Do Steps 3 and 4 of Section 17.2.

NOTE

Consult the factory for additional information regarding service or repair.

Note: Please see [website](#) for most recent Declaration.

	EU Declaration of Conformity (No. 1700903)	
		1056-AA-BB-CC-DD-EE
This declaration is issued under the sole responsibility of the manufacturer: Rosemount Inc., 8200 Market Blvd., Chanhassen, MN 55317 USA The product,		
Rosemount Dual Input Intelligent Analyzer model 1056-AA-BB-CC-DD-EE		
Where		
AA is Power:	BB is Measurement 1:	CC is Measurement 2:
01 115/230VAC, no relays	20 Contacting Conductivity	30 Contacting Conductivity
02 24 VDC, 4 alarm relays	21 Toroidal Conductivity	31 Toroidal Conductivity
03 85-265VAC, 4 alarm relays	22 pH/ORP/ISP	32 pH/ORP/ISP
	23 Flow/Current	33 Flow/Current
	24 Chlorine	34 Chlorine
	25 Dissolved Oxygen	35 Dissolved Oxygen
	26 Ozone	36 Ozone
	27 Turbidity	37 Turbidity
		38 None
		DD is Communication Output:
		AN 4-20 mA analog signaling
		HT 4-20 mA plus HART comm.
		DP Profibus protocol
		EE is UL option:
		Blank if no selection
		UL UL, Ordinary Location
to which this declaration relates, is in conformity with relevant Union harmonization legislation:		
(2014/30/EU)	EMC Directive	
(2014/35/EU)	Low Voltage Directive	
Assumption of conformity is based on the application of the harmonized standards:		
EN 61326-1:2006	Electrical equipment for measurement, control and laboratory use. EMC requirements. General requirements	
EN 61010-1:2010	Safety requirements for electrical equipment for measurement, control, and laboratory use. General requirements	
<hr/>		
		
(Signature)		
Kim Freeman		
(Name printed)		
	Director of Global Quality	
	(Function name)	
	March 28, 2017	
	(Date of issue)	
CE marking was first affixed to this product in 2007		

www.Emerson.com/RosemountLiquidAnalysis



[Youtube.com/user/Rosemount](https://www.youtube.com/user/Rosemount)



Analyticexpert.com



[Twitter.com/Rosemount_News](https://twitter.com/Rosemount_News)



facebook.com/Rosemount

Emerson

8200 Market Blvd.
Chanhassen, MN 55317,
USA

Tel +1 800 999 9307
Fax +1 952 949 7001

Liquid.CSC@Emerson.com

©2017 Emerson. All rights reserved.

The Emerson logo is a trademark and service mark of Emerson Electric Co. Rosemount is a mark of one of the Emerson family of companies. All other marks are the property of their respective owners.

The contents of this publication are presented for information purposes only, and while effort has been made to ensure their accuracy, they are not to be construed as warranties or guarantees, express or implied, regarding the products or services described herein or their use or applicability. All sales are governed by our terms and conditions, which are available on request. We reserve the right to modify or improve the designs or specifications of our products at any time without notice.

ROSEMOUNT™

