



DW 18 SERIES Technical Datasheet

Mechanical Flow Controller

- Mechanical, autonomous flow switches - no power supply needed
- For horizontal and vertical pipes from DN 15 up to DN 3000 - and higher
- High reliability and repeatability up to 300°C / 570°F



The Mechanical Flow Controller

The DW 18 series of flow controller is ideal for locally indicating the flow of homogenous clean liquids. Adjustable switches generate alarms once switching points are reached.

The units are robust. Several variants are available to suit a wide variety of applications.

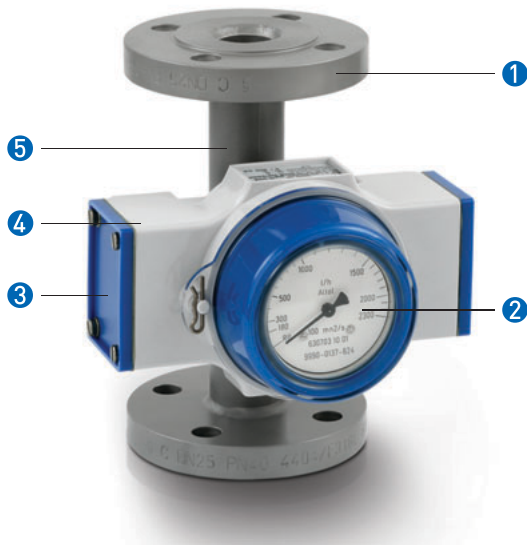

- ❶ Mounting options: flange, threaded or insertion-type
- ❷ Indicator options: linear scale with flow limits or dial
- ❸ Wiring compartment with cable gland
- ❹ Plastic housing with or without indicator
- ❺ Material options: Bronze, stainless steel, low-carbon steel or carbon steel with stainless steel cladding

Highlights

- Proven technology - for more than thirty years
- Bistable reed switches, SPDT switches and relays available
- Optional second limit switch
- Switch position can be adjusted under process conditions
- Suitable for pipes DN 15...3000 or ½...120" in diameter
- High-temperature version (without indicator) for operating conditions up to 300°C / 570°F
- Housing is removable under process conditions
- Optional approval for EEx I or EEx d applications
- No maintenance needed

Industries

- Petrochemical
- Oil & Gas
- Chemical
- Water
- Air-conditioning (HVAC)

Applications

- Flow detection
- Cooling systems
- Pump protection
- Lubrication control
- Cavitation alarm

Variants



DW 181 flow controller

The DW 181 inline flow controller is suitable for horizontal or vertical pipes. It can have G or NPT threaded connections, sizes ranging from $\frac{3}{4}$...2". The measuring tube and connection are made of either bronze or 316 L (1.4404) stainless steel. There are two types of indicator available for this variant:

- a linear scale with up to two alarm positions at the top and bottom of the indicator (as shown) or
- a dial which has been made specifically for this instrument and tested on a calibration rig.

For information on DW 181 flow ranges, please refer to the flow range tables.



DW 182 flow controller

The DW 182 inline flow controller is suitable for horizontal or vertical pipes. It has flanged connections, sizes ranging from DN 15...DN 65 or from $\frac{1}{2}$...2 $\frac{1}{2}$ ". The measuring tube and connection is made of 316 L (1.4404) stainless steel. There are two types of indicator available for this variant:

- a linear scale with up to two alarm positions at the top and bottom of the indicator or
- a dial (as shown) which has been made specifically for the instrument and tested on a calibration rig.

For information on DW 182 flow ranges, please refer to the flow range tables.



DW 183 flow controller

The DW 183 inline flow controller is suitable for horizontal or vertical pipes. It has with flanged connections , sizes ranging from DN 65...DN 200 and 2½...8". The measuring tube and connection is made of either XC 18 (1020) carbon steel or 316 L (1.4404) stainless steel. Carbon steel flanges with nominal diameters bigger than 100 or 4" can have 316 L stainless steel cladding. There are two types of indicator available for this variant:

- a linear scale with up to two alarm positions at the top and bottom of the indicator or
- a dial (as shown) which has been made specifically for this instrument and tested on a calibration rig.

For information on DW 183 flow ranges, please refer to the flow range tables.



DW 184 flow controller

The DW 184 insertion-type flow controller checks flow velocity. It is suitable for horizontal and vertical pipes with nominal diameters of 250 mm / 10" or bigger - there is no maximum pipe diameter. It is installed on a DN 150 PN 16/40 or 6" ASME150/300 lbs mounting flange.

The measuring tube and connection is made of either 1020 (XC 18) carbon steel or 316 L (1.4404) stainless steel. A mounting flange made of carbon steel can also have 316 L stainless steel cladding. One type of indicator is available for this variant:

- a linear scale with alarm positions at the top and bottom of the indicator.

For information on DW 184 flow velocity ranges, please refer to the flow range tables.

Options

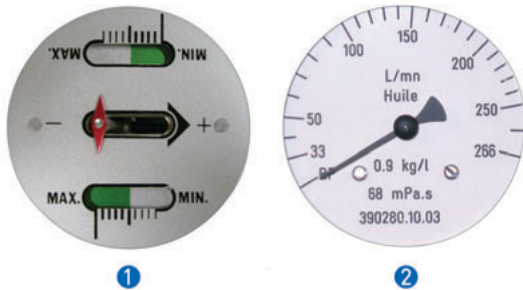

1

2

Indicator options

Standard and intrinsically-safe flow switches are equipped with a local indicator. There are two types:

- 1 The type G linear indicator is supplied as standard for all variants. Up to two switching points (alarm positions) are indicated at the top and the bottom of the indicator. The switching points are set according to customer order and tested on a calibration rig. Switching points can be changed during operation.
- 2 The type A dial indicator is optional for the DW 181, DW 182 and DW 183. It has been made specifically for the instrument and tested on a calibration rig. Switching points can be changed during operation.

ATEX approval: intrinsically-safe devices

The DW 18 intrinsically-safe (Ex i) flow switch has the same housing as a standard device. Type G or A indicators are available. It is suitable for use in potentially explosive atmospheres.

A DW 18 with this option is in equipment category 1 GD.



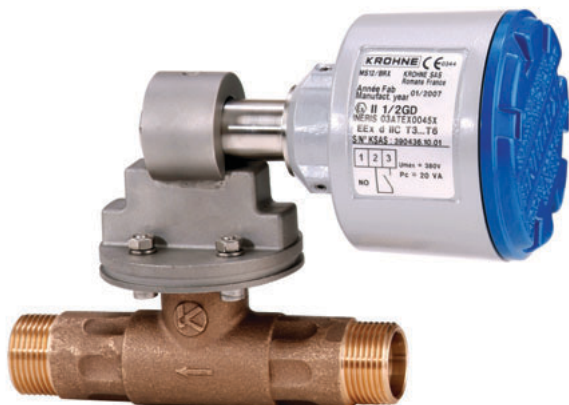

ATEX approval: explosion-proof devices

The DW 18 explosion-proof (EEx d) flow switch has an aluminium housing without an indicator. It is suitable for use in potentially explosive atmospheres. It is possible to change the switch position under process conditions.

A DW 18 with this option is in equipment category 1/2 GD.

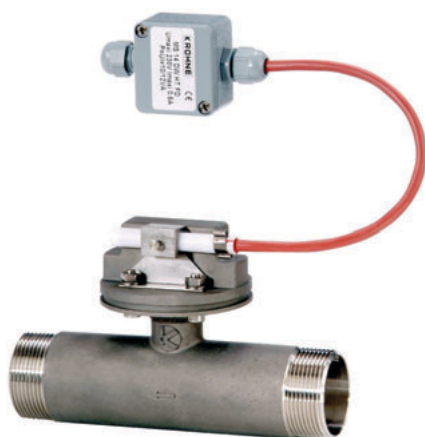

High-temperature (HT) option

The DW 18 high-temperature (HT) flow switch is suitable for operating conditions up to 300°C / 570°F. It does not have an indicator. The switch is sheathed in a PTFE cartridge. It is possible to change the switch position under process conditions.

Technical data: inline instruments

	DW 181	DW 182	DW 183
--	--------	--------	--------

Functions

Description	Flow switch		
Function	Monitors flow in horizontal or vertical pipes		
User interface options	Linear scale (type G) ①		
	Dial (type A) ①	Dial (type A) ②	
Scale marking options	l/h, m ³ /h or US GPM ③		

Design

Installation type	Inline connection
-------------------	-------------------

Measurement accuracy

Repeatability	±3%		
Accuracy	±15% ④		
Reference temperature	+20°C ±5°C / +70°F ±10°F		
Reference pressure	1013 mbar abs. ±20 mbar / 14.69 psig ±0.29 psig		
Reference relative humidity	60% ±15%		
Reference product	Water		
Measuring range	0.09...30 m ³ /h / 0.09...132 US GPM ⑤	0.02...30 m ³ /h / 0.09...132 US GPM ⑤	10...250 m ³ /h / 44...1100 US GPM ⑤

Operating conditions

Ambient temperature			
Standard housing	-40...+80°C / -40...+175°F (EEx: see supplementary operating instructions or approval certificates)		
EEx d housing	EEx: see supplementary operating instructions or approval certificates		
High-temperature housing	-25...+60°C / -15...+140°F		
Storage temperature	-40...+85°C / -40...+185°F		
Process temperature			
Standard housing	-40...+120°C / -40...+250°F (EEx: see supplementary operating instructions or approval certificates)		
Ventilated housing	-40...+150°C / -40...+300°F		
EEx d housing	EEx: see supplementary operating instructions or approval certificates		
High-temperature housing	-25...+300°C / -15...+570°F		
Max. allowable operating pressure,	As given below and according to the flange pressure rating. See "Process connections".		
Standard	40 bar / 580 psig		16 bar / 232 psig

	DW 181	DW 182	DW 183
Dangerous fluids (Group 1, Directive 67/548/CEE)	n/a		with DN150 PN16 flanges: <13 bar or 190 psig with DN80 PN40 flanges: <25 bar or 362 psig
Viscosity, standard variants	≤30 mPas/ 0.02 lb/fts		
Viscosity, special variants	≤250 mPas/ 0.168 lb/fts		
Protection category acc. to EN 60529			
Standard variants	IP 55		
High-temperature option	IP 44		
EEx d option	IP 65		

Installation conditions

Minimum inlet run	5 x nominal diameter, depending on the flow profile
Minimum outlet run	2 x nominal diameter, depending on the flow profile

Materials

Measuring tube	Bronze; SS 316 L (1.4404)	SS 316 L (1.4404)	XC 18 (1020) steel; SS 316 L (1.4404)
Measuring system assembly	SS 316 L (1.4404)		
Connection	Bronze; SS 316 L (1.4404) ⁶	SS 316 L (1.4404)	XC 18 (1020) steel; SS 316 L (1.4404); SS 316 L (1.4404)-clad carbon steel ⁷
Housing - non-Ex/Ex I versions	Polycarbonate		
Housing - Ex d version	Aluminium		
Wiring box - HT version	Aluminium		
Switch sheath - HT version	PTFE		
Electric cable sheath - HT version	Fibre glass		
Gasket			
Standard	Perbunan, FKM/FPM; Silicone; Klingerit		
High-temperature (HT)	Klingerit; fully welded housing on request		
Cap (Pressure housing)	SS 316 L (1.4404)		

Process connections

Thread	G ¾...2; NPT ¾...2	-	
Flange, DIN 2526 - PN40 - Form C	-	DN15...50	DN80
Flange, DIN 2526 - PN16 - Form C	-	DN65	DN65, DN100...150
Flange, DIN 2526 - PN10 - Form C	-		DN200 ⁸
Flange, ASME B16.5 - 150 lbs RF	-	½...2½"	2½...8"
Flange, ASME B16.5 - 300 lbs RF	-	½...2½"	-

	DW 181	DW 182	DW 183
--	--------	--------	--------

Power supply

Instrument terminal	Refer to the "Switch options" page
---------------------	------------------------------------

Input and output

Parameter	Flow rate
Output signal	Refer to the "Switch options" page

Approvals

ATEX	ATEX II 1 G/D EEx ia IIC T6...T3 IP65 T195°C...T80°C; ATEX II 1/2 G/D EEx d IIC T6...T3 IP65 T195°C...T80°C ⑨
------	--

① Not available for EEx d and HT options

② Not available for EEx d and HT options. For connection sizes DN ≤100 or ≤4" only.

③ With type A dial only

④ With type A dial only

⑤ See flow range tables

⑥ NPT connections: 316 L (1.4404) stainless steel only

⑦ Carbon steel flanges with nominal diameters bigger than 100 mm or 4" can have stainless steel cladding

⑧ PN16 on request

⑨ no indicator available for the EEx d version. EEx approval not available for the high-temperature option. Refer also to the "Switch options" page.

Technical data: insertion-type instruments

	DW 184
--	--------

Functions

Description	Flow switch
Function	Monitors flow in horizontal or vertical pipes
User interface options	Linear scale (type G) - not available for EEx d and HT options

Design

Installation type	Insertion-type connection for pipe diameters \geq DN250 or 10"
-------------------	--

Measurement accuracy

Repeatability	$\pm 3\%$
Reference temperature	+20°C $\pm 5^\circ\text{C}$ / +70°F $\pm 10^\circ\text{F}$
Reference pressure	1013 mbar abs. ± 20 mbar / 14.69 psig ± 0.29 psig
Reference relative humidity	60% $\pm 15\%$
Reference product	Water
Measuring range	0.2...4 m/s / 0.66...1.31 ft/s, see flow range tables

Operating conditions

Ambient temperature	
Standard housing	-40...+80°C / -40...+175°F (EEx: see supplementary operating instructions or approval certificates)
EEx d housing	EEx: see supplementary operating instructions or approval certificates
High-temperature (HT) housing	-25...+60°C / -15...+140°F
Storage temperature	-40...+85°C / -40...+185°F
Process temperature	
Standard housing	-40...+120°C / -40...+250°F (EEx: see supplementary operating instructions or approval certificates)
Ventilated housing	-40...+150°C / -40...+300°F
EEx d housing	EEx: see supplementary operating instructions or approval certificates
High-temperature (HT) housing	-25...+300°C / -15...+570°F
Max. allowable operating pressure	40 bar or 580 psig, according to the flange pressure rating
Viscosity	
Standard variants	≤ 30 mPas/ 0.02 lb/fts
Special variants	< 90 mPas/ 0.06 lb/fts
Protection category acc. to EN 60529	
Standard variants	IP 55
High-temperature option	IP 44
EEx d option	IP 65

	DW 184
--	--------

Installation conditions

Minimum inlet run	5 x nominal diameter, depending on the flow profile
Minimum outlet run	2 x nominal diameter, depending on the flow profile
Mounting flange clearance above pipeline	50 mm or 2", see "Process connections"

Materials

Measuring tube	SS 316 L (1.4404)
Measuring system assembly	
Connection	XC 18 (1020) steel; SS 316 L (1.4404); SS 316 L (1.4404)-clad carbon steel
Housing - non-Ex/Ex I versions	Polycarbonate
Housing - Ex d version	Aluminium
Wiring box - HT version	
Switch sheath - HT version	PTFE
Electric cable sheath - HT version	Fibre glass
Gasket	
Standard	Perbunan; FKM/FPM; Silicone; Klingerit
High-temperature (HT)	Klingerit
Cap (Pressure housing)	SS 316 L (1.4404)

Process connections

Flange, DIN 2526 - PN40 - Form C	DN150 (PN25/40) - this is a mounting flange for the insertion-type device. For pipelines \geq DN250 / 10".
Flange, DIN 2526 - PN16 - Form C	
Flange, ASME B16.5 - 150 lbs RF	6" - this a mounting flange for the insertion-type device. For pipelines \geq DN250 / 10".
Flange, ASME B16.5 - 300 lbs RF	

Power supply

Instrument terminal	Refer to the "Switch options" page
---------------------	------------------------------------

Input and output

Parameter	Flow velocity
Output signal	Refer to the "Switch options" page

Approvals

ATEX	ATEX II 1 G/D EEx ia IIC T6...T3 IP65 T195°C...T80°C; ATEX II 1/2 G/D EEx d IIC T6...T3 IP65 T195°C...T80°C ①
------	--

① No indicator available for the EEx d version. EEx approval not available for the high-temperature option. Refer also to the "Switch options" page.

Switch options

The DW 18 series has a large number of switch and relay options.

The DW 18 series can be equipped with either:

- 1 or 2 SPST (single pole, single throw) switches for standard applications,
- 1 or 2 SPST switches for high-temperature (HT) applications,
- 1 SPDT (single pole, double throw) switch, or
- 1 or 2 DPDT (double pole, double throw) relay amplifiers for higher switching capacities.

The normal state of an SPST switch is either N/C, normally closed, or N/O, normally open. N/C switches are closed during operation (closed when flow increases). N/O switches are open during operation (closed when flow decreases).

Switch name	None	K1		K1 (HT)		KV1	K2			K2 (HT)			KV2			
Output type	-	SPST switch	SPDT switch	SPST switch	DPDT relay		2 SPST switches			2 SPST switches			2 DPDT relays			
Switch state	-	N/C	N/O	Changeover	N/C	N/O	-	2 N/C	1N/C + 1N/O	1N/O + 1N/C	2 N/O	2 N/C	1N/C + 1N/O	1N/O + 1N/C	2 N/O	-

Housing options

Standard: indicator G																			
Standard: indicator A ①																			
High-temperature (HT) ②																			
EEx d-approved ②																			

Approvals

ATEX, EEx ia																			
ATEX, EEx d																			

■ standard ■ optional □ on request

① Option not available for the DW 184 flow controller

② Without indicator

Power supply

Instrument terminal - KV1 relay	240/110/48/24 VAC; 110/48/24 VDC
Instrument terminal - KV2 relays	240/110/48/24 VAC; 110/48/24 VDC
Cable entry - non-Ex/Exi option	PG13.5
Cable entry - Exd option	M20x1.5, M25x1.5 or NPT ¾
Cable entry - HT option	PG9

Input and output

K1 switch	
SPST max. switching capacity	14 VA (max. 350 VDC, max. 0.4 A)
SPDT max. switching capacity	3 VA (max. 28 VDC, max. 0.25 mA)
EEx i supply characteristics	$I_i < 500 \text{ mA}$, $C_i = 0 \text{ nF}$, $L_i = 0 \text{ }\mu\text{F}$
EEx d power characteristics	20 VA (max. 380 VAC, max. 1.5 A)
K1(HT) switch	
SPST max. switching capacity ❶	18 VA (max. 220 VAC, max. 0.8 A)
K2 switches	
SPST max. switching capacity	14 VA (max. 350 VDC, max. 0.4 A)
EEx i supply characteristics	$I_i < 500 \text{ mA}$, $C_i = 0 \text{ nF}$, $L_i = 0 \text{ }\mu\text{F}$
K2(HT) switches	
SPST max. switching capacity ❶	18 VA (max. 220 VAC, max. 0.8 A)
KV1 relay, KV2 relays	
DPDT relay max. switching capacity	2000 VA (max. 250 VAC, max. 8 A)
Response time	5...12 ms

❶ With high-temperature (HT) option. EEx approvals are not available.

Flow range tables

Use the tables that follow for the selection of devices and their flow range. Quote the code given.

DW 181 flow ranges

Thread connection	Code	Flow range		Pressure loss			
				Pmax for qmin		Pmax for qmax	
		G / NPT	[l/h]	[US GPM]	[mbar]	[psig]	[mbar]
[inches]							
3/4	C 011	20...160	0.09...0.70	16	0.23	80	1.16
	C 012	50...400	0.22...1.76	67	0.97	176	2.55
	C 013	150...1000	0.66...4.40	140	2.03	440	6.38
	C 014	300...2500	1.32...11.01	150	2.18	490	7.11
	E 015 ①	64...160	0.28...0.70	65	0.94	370	5.37
	E 016 ①	100...250	0.44...1.10	150	2.18	870	12.62
	E 017 ①	160...400	0.70...1.76	18	0.26	110	1.60
	E 018 ①	250...630	1.10...2.77	40	0.58	270	3.92
	E 019 ①	400...1000	1.76...4.40	18	0.26	110	1.60
1	C 021	200...1600	0.88...7.04	18	0.26	80	1.16
	C 022	300...2500	1.32...11.01	26	0.38	180	2.61
	C 023	500...4000	2.20...17.61	85	1.23	400	5.80
	E 025	640...1600	2.82...7.04	15	0.22	110	1.60
	E 026	1000...2500	4.40...11.01	45	0.65	240	3.48
	E 027	1600...4000	7.04...17.61	25	0.36	140	2.03
1 1/2	C 041	500...4000	2.20...17.61	14	0.20	68	0.99
	C 042	800...6300	3.52...27.74	32	0.46	110	1.60
	C 043	1200...10000	17.61...44.03	60	0.87	160	2.32
	E 045	2500...6300	11.01...27.74	15	0.22	100	1.45
	E 046	4000...10000	17.61...44.03	50	0.73	260	3.77
2	C 051	1200...10000	5.28...44.03	30	0.44	80	1.16
	C 052	2000...16000	8.81...70.45	65	0.94	260	3.77
	C 053	2500...20000	11.01...88.06	72	1.04	350	5.08
	C 054	7500...30000	33.02...132.09	47	0.68	360	5.22
	E 055	6400...16000	28.18...70.45	20	0.29	110	1.60
	E 056	8000...20000	35.22...88.06	30	0.44	140	2.03

① only with indicator G

DW 182 flow ranges

DIN 2526 flanges		ANSI B16.5 flanges		Code	Flow range		Pressure loss			
DN	PN	NPS	Rating class				Pmax for qmin		Pmax for qmax	
[mm]	[bar]	[inches]	[lbs]		[l/h]	[US GPM]	[mbar]	[psig]	[mbar]	[psig]
15	40	½	150 / 300	C 011	20...160	0.09...0.70	16	0.23	80	1.16
				C 012	50...400	0.22...1.76	67	0.97	176	2.55
				C 013	150...1000	0.66...4.40	140	2.03	440	6.38
				C 014	300...2500	1.32...11.01	150	2.18	490	7.11
				E 015 ①	64...160	0.28...0.70	65	0.94	370	5.37
				E 016 ①	100...250	0.44...1.10	150	2.18	870	12.62
				E 017 ①	160...400	0.70...1.76	18	0.26	110	1.60
				E 018 ①	250...630	1.10...2.77	40	0.58	270	3.92
				E 019 ①	400...1000	1.76...4.40	18	0.26	110	1.60
25	40	1	150 / 300	C 021	200...1600	0.88...7.04	18	0.26	80	1.16
				C 022	300...2500	1.32...11.01	26	0.38	180	2.61
				C 023	500...4000	2.20...17.61	85	1.23	400	5.80
				E 025	640...1600	2.82...7.04	15	0.22	110	1.60
				E 026	1000...2500	4.40...11.01	45	0.65	240	3.48
				E 027	1600...4000	7.04...17.61	25	0.36	140	2.03
40	40	1½	150 / 300	C 041	500...4000	2.20...17.61	14	0.20	68	0.99
				C 042	800...6300	3.52...27.74	32	0.46	110	1.60
				C 043	1200...10000	17.61...44.03	60	0.87	160	2.32
				E 045	2500...6300	11.01...27.74	15	0.22	100	1.45
				E 046	4000...10000	17.61...44.03	50	0.73	260	3.77
50	40	2	150 / 300	C 051	1200...10000	5.28...44.03	30	0.44	80	1.16
				C 052	2000...16000	8.81...70.45	65	0.94	260	3.77
				C 053	2500...20000	11.01...88.06	72	1.04	350	5.08
				C 054	7500...30000	33.02...132.09	47	0.68	360	5.22
				E 055	6400...16000	28.18...70.45	20	0.29	110	1.60
				E 056	8000...20000	35.22...88.06	30	0.44	140	2.03

DIN 2526 flanges		ANSI B16.5 flanges		Code	Flow range		Pressure loss			
DN	PN	NPS	Rating class				Pmax for qmin		Pmax for qmax	
[mm]	[bar]	[inches]	[lbs]		[l/h]	[US GPM]	[mbar]	[psig]	[mbar]	[psig]
65	16	2½	150 / 300	C 051	1200...10000	5.28...44.03	30	0.44	80	1.16
				C 052	2000...16000	8.81...70.45	65	0.94	260	3.77
				C 053	2500...20000	11.01...88.06	72	1.04	350	5.08
				C 054	7500...30000	33.02...132.09	47	0.68	360	5.22
				E 055	6400...16000	28.18...70.45	20	0.29	110	1.60
				E 056	8000...20000	35.22...88.06	30	0.44	140	2.03

① only with indicator G

DW 183 flow ranges

DIN 2526 flanges		ANSI B16.5 flanges		Indicator G			Indicator A			Pressure loss	
DN	PN	NPS	Rating class	Code	Flow range		Code	Flow range			
[mm]	[inches]	[inches]	[lbs]		[m³/h]	[US GPM]		[m³/h]	[US GPM]		
65	16	2 1/2	150	P 081	10...24	44...106	-	-	-	10	0.15
				P 082	16...40	70...176	P 086	10...40	44...176	20	0.29
				P 083	20...50	88...220	P 087	13...50	55...220	10	0.15
				P 084	24...60	106...264	P 088	15...60	66...264	12	0.17
				P 085	28...70	123...308	P 089	17...70	75...308	12	0.17
80	16	3	150	P 081	10...24	44...106	-	-	-	10	0.15
				P 082	16...40	70...176	P 086	10...40	44...176	20	0.29
				P 083	20...50	88...220	P 087	13...50	55...220	10	0.15
				P 084	24...60	106...264	P 088	15...60	66...264	12	0.17
				P 085	28...70	123...308	P 089	17...70	75...308	12	0.17
100	16	4	150	P 101	16...40	70...176	-	-	-	10	0.15
				P 102	24...60	106...264	P 106	15...60	66...264	23	0.33
				P 103	32...80	141...352	P 107	20...80	88...352	14	0.20
				P 104	40...100	176...440	P 108	25...100	110...440	23	0.33
				P 105	48...120	211...528	P 109	30...120	132...528	33	0.48
125	16	5	150	P 121	24...60	106...264	-	-	-	20	0.29
				P 122	40...100	176...440	P 126	25...100	110...440	24	0.35
				P 123	48...120	211...528	P 127	30...120	132...528	26	0.38
				P 124	60...150	264...660	P 128	37...150	163...660	24	0.35
				P 125	70...180	308...793	P 129	45...180	198...793	30	0.44
150	16	6	150	P 151	40...100	176...440	-	-	-	30	0.44
				P 152	60...150	264...660	P 156	37...150	163...660	32	0.46
				P 153	70...180	308...793	P 157	45...180	198...793	37	0.54
				P 154	90...220	396...528	P 158	55...220	242...969	34	0.49
				P 155	100...250	440...1101	P 159	65...250	286...1101	30	0.44
200	10 ①	8	150	P 201	60...150	264...660	-	-	-	35	0.51
				P 202	70...180	308...793	-	-	-	40	0.58
				P 203	90...220	396...969	P 205	55...220	242...969	44	0.64
				P 204	100...250	440...1101	P 206	65...250	286...1101	40	0.58

① PN 16 on request

DW 184 flow velocity ranges

DIN 2526 flanges		ANSI B16.5 flanges		Indicator G		
DN	PN	NPS	Rating class	Flow velocity		Rangeability
[mm]	[bar]	[inches]	[lbs]	[m/s]	[ft/s]	
150 ①	16 / 40	6 ①	150 / 300	0.2...0.4	0.66...1.31	1 : 2
				0.2...1	1.31...3.28	1 : 2.5
				1...4	3.28...13.12	1 : 4
				4	13.12	1 : 4

① mounting flange size for insertion-type flow controller. For process pipes diameters ≥ 250 mm/10" in diameter.

Dimensions and Weight

DW 181 non-Ex / Exi side view

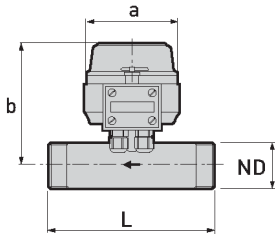

DW 181 non-Ex / Exi top view

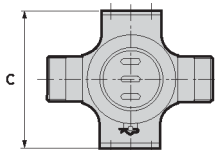

Note:

- The customer must supply cable glands for EEx d-approved flow controllers with Aluminium housings. The standard size for the cable entry is M20 x 1.5. M25 x 1.5 and NPT 3/4 cable entries are also available on demand.
- Standard and EEx i-approved flow controllers have PG 13.5 cable glands.
- High-temperature flow controllers have PG 9 cable glands.

Thread connection, ND	Dimensions [mm]				Weight [kg]
G [inches]	a	b	c	L	
3/4	Ø100	115	170	135	1.7
1	Ø100	120	170	160	1.8
1 1/2	Ø100	130	170	180	2.2
2	Ø100	135	170	190	2.6

Thread connection, ND	Dimensions [inches]				Weight [lbs]
NPT [inches]	a	b	c	L	
3/4	Ø4	4.5	6.7	5.3	1.7
1	Ø4	4.7	6.7	6.3	1.8
1 1/2	Ø4	5.1	6.7	7.1	2.2
2	Ø4	5.3	6.7	7.5	2.6

Thread connection, ND	Dimensions [mm]				Weight [kg]
G [inches]	b	e	f	L	
3/4	140	130	Ø98	135	2.35
1	145	130	Ø98	160	2.45
1 1/2	155	130	Ø98	180	2.85
2	160	130	Ø98	190	3.25

Thread connection, ND	Dimensions [inches]				Weight [lbs]
NPT [inches]	b	e	f	L	
3/4	5.5	5.1	Ø3.9	5.3	5.2
1	5.7	5.1	Ø3.9	6.3	5.4
1 1/2	6.1	5.1	Ø3.9	7.1	6.3
2	6.3	5.1	Ø3.9	7.5	7.2

Thread connection, ND	Dimensions [mm]				Weight [kg]
G [inches]	b	j	k	L	
3/4	76	50.4	45.4	135	1.1
1	81	50.4	45.4	160	1.2
1 1/2	91	50.4	45.4	180	1.6
2	96	50.4	45.4	190	2.0

Thread connection, ND	Dimensions [inches]				Weight [lbs]
NPT [inches]	b	j	k	L	
3/4	3.0	2.0	1.8	5.3	2.4
1	3.2	2.0	1.8	6.3	2.6
1 1/2	3.6	2.0	1.8	7.1	3.5
2	3.8	2.0	1.8	7.5	4.4

DW 181 Exd side view

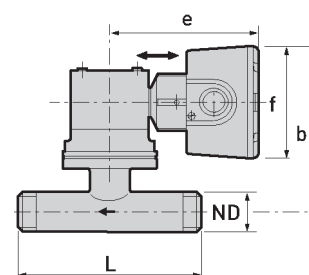

DW 181 Exd top view

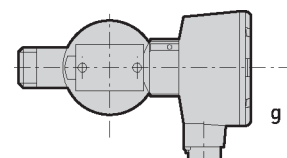

DW 181 HT side view

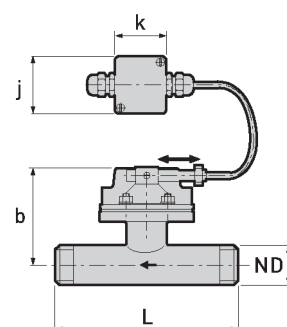

DW 182 non-Ex / Exi side view

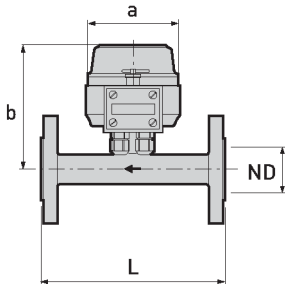

DW 182 non-Ex / Exi top view

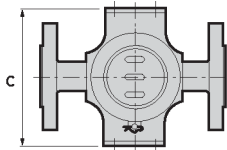

DIN 2526 flanges, ND		Dimensions [mm]				Weight [kg]
DN [mm]	PN [bar]	a	b	c	L	
15	40	Ø100	115	170	200	3.0
25	40	Ø100	120	170	200	4.0
40	40	Ø100	130	170	200	5.5
50	40	Ø100	135	170	200	7.2
65	16	Ø100	135	170	200	9.3

ANSI B16.5 flanges, ND		Dimensions [inches]				Weight [lbs]
NPS [inches]	Rating class [lbs]	a	b	c	L	
1/2	150 / 300	Ø4	4.5	6.7	7.9	6.6
1	150 / 300	Ø4	4.7	6.7	7.9	8.8
1 1/2	150 / 300	Ø4	5.1	6.7	7.9	12.1
2	150 / 300	Ø4	5.3	6.7	7.9	15.9
2 1/2	150 / 300	Ø4	5.3	6.7	7.9	20.5

DW 182 Exd side view

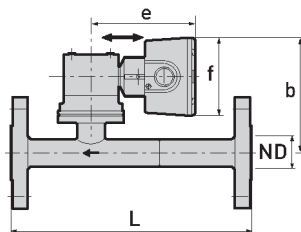

DW 182 Exd top view

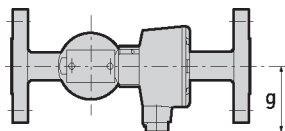

DIN 2526 flanges, ND		Dimensions [mm]					Weight [kg]
DN [mm]	PN [bar]	b	e	f	g	L	
15	40	140	130	Ø98	90	300	3.7
25	40	145	130	Ø98	90	300	4.7
40	40	155	130	Ø98	90	300	6.2
50	40	160	130	Ø98	90	300	7.9
65	16	160	130	Ø98	90	300	10.0

ANSI B16.5 flanges, ND		Dimensions [inches]					Weight [lbs]
NPS [inches]	Rating class [lbs]	b	e	f	g	L	
1/2	150 / 300	5.5	5.1	Ø3.9	3.5	11.8	8.1
1	150 / 300	5.7	5.1	Ø3.9	3.5	11.8	10.3
1 1/2	150 / 300	6.1	5.1	Ø3.9	3.5	11.8	13.6
2	150 / 300	6.3	5.1	Ø3.9	3.5	11.8	17.3
2 1/2	150 / 300	6.3	5.1	Ø3.9	3.5	11.8	21.9

DIN 2526 flanges, ND		Dimensions [mm]				Weight [kg]
DN [mm]	PN [bar]	b	j	k	L	
15	40	76	50.4	45.4	200	2.4
25	40	81	50.4	45.4	200	3.4
40	40	91	50.4	45.4	200	4.9
50	40	96	50.4	45.4	200	6.6
65	16	96	50.4	45.4	200	8.7

ANSI B16.5 flanges, ND		Dimensions [inches]				Weight [lbs]
NPS [inches]	Rating class [lbs]	b	j	k	L	
1/2	150 / 300	3.0	2.0	1.8	7.9	5.3
1	150 / 300	3.2	2.0	1.8	7.9	7.5
1 1/2	150 / 300	3.6	2.0	1.8	7.9	10.8
2	150 / 300	3.8	2.0	1.8	7.9	14.6
2 1/2	150 / 300	3.8	2.0	1.8	7.9	19.2

DIN 2526 flanges, ND		Dimensions [mm]			Weight [kg]
DN [mm]	PN [bar]	a	b	L	
65	16	∅100	185	200	11.5
80	40	∅100	185	200	12.5
100	16	∅100	195	200	14.0
125	16	∅100	210	300	18.0
150	16	∅100	220	300	23.0
200	10 ①	∅100	250	300	35.0

① PN 16 on request

ASME B16.5 flanges, ND		Dimensions [inches]			Weight [lbs]
NPS [inches]	Rating class [lbs]	a	b	L	
2 1/2	150	∅4	7.3	7.9	25.4
3	150	∅4	7.3	7.9	27.6
4	150	∅4	7.7	7.9	30.9
5	150	∅4	8.3	11.8	39.7
6	150	∅4	8.7	11.8	50.7
8	150	∅4	9.8	11.8	77.2

DW 182 HT side view

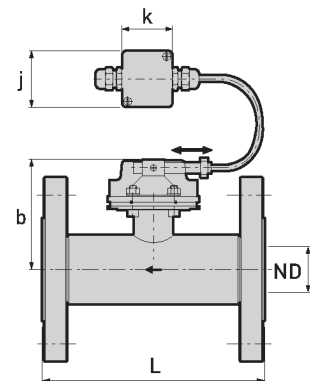

DW 183 non-Ex / Exi side view

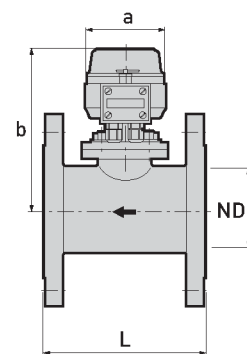

DW 183 Exd side view

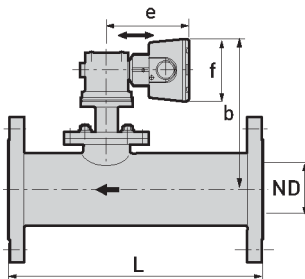

DW 183 Exd top view

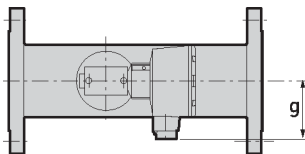

DIN 2526 flanges, ND		Dimensions [mm]					Weight [kg]
DN [mm]	PN [bar]	b	e	f	g	L	
65	16	210	130	Ø98	90	400	12.2
80	40	210	130	Ø98	90	400	13.2
100	16	220	130	Ø98	90	400	14.6
125	16	232	130	Ø98	90	400	18.7
150	16	245	130	Ø98	90	400	23.7
200	10 ①	275	130	Ø98	90	400	35.7

① PN 16 on request

ANSI B16.5 flanges, ND		Dimensions [inches]					Weight [lbs]
NPS [inches]	Rating class [lbs]	b	e	f	g	L	
2 1/2	150	8.3	5.1	Ø3.9	3.5	15.7	26.8
3	150	8.3	5.1	Ø3.9	3.5	15.7	29.0
4	150	8.7	5.1	Ø3.9	3.5	15.7	32.3
5	150	9.1	5.1	Ø3.9	3.5	15.7	41.1
6	150	9.7	5.1	Ø3.9	3.5	15.7	52.1
8	150	10.8	5.1	Ø3.9	3.5	15.7	78.6

DW 183 HT side view

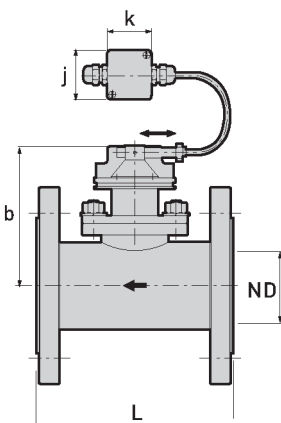

DIN 2526 flanges, ND		Dimensions [mm]				Weight [kg]
DN [mm]	PN [bar]	b	j	k	L	
65	16	146	50.4	45.4	200	10.9
80	40	146	50.4	45.4	200	11.9
100	16	156	50.4	45.4	200	13.4
125	16	168	50.4	45.4	300	17.4
150	16	181	50.4	45.4	300	22.4
200	10 ①	211	50.4	45.4	300	34.4

① PN 16 on request

ANSI B16.5 flanges, ND		Dimensions [inches]				Weight [lbs]
NPS [inches]	Rating class [lbs]	b	j	k	L	
2 1/2	150	5.6	2.0	1.8	7.9	24.0
3	150	5.6	2.0	1.8	7.9	26.2
4	150	6.1	2.0	1.8	7.9	29.4
5	150	6.6	2.0	1.8	11.8	38.4

ANSI B16.5 flanges, ND		Dimensions [inches]				Weight [lbs]
NPS [inches]	Rating class [lbs]	b	j	k	L	
6	150	7.1	2.0	1.8	11.8	49.4
8	150	8.3	2.0	1.8	11.8	75.8

DIN 2526 flanges		Dimensions [mm]					Weight [kg]
DN [mm]	PN [bar]	a	m	n	p	q	
150 ①	16 / 40	Ø100	170	280	125	Ø125	3.0

① mounting flange size for DW 184 insertion-type flow controller. For process pipe diameters ≥ 250 mm.

ANSI B16.5 flanges		Dimensions [inches]					Weight [lbs]
NPS [inches]	Rating class [lbs]	a	m	n	p	q	
6 ①	150 / 300	Ø4	6.7	11.0	4.9	Ø2.4	29.8

① mounting flange size for DW 184 insertion-type flow controller. For process pipe diameters ≥ 10 inches.

DW 184 non-Ex/Exi side view

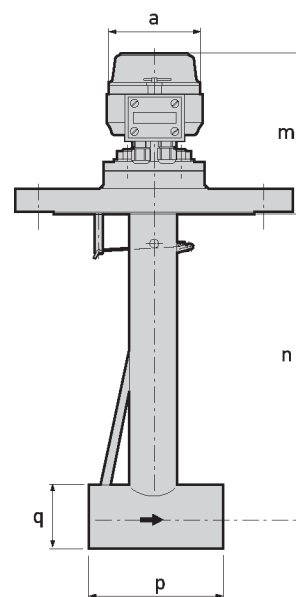

DW 184 Exd side view

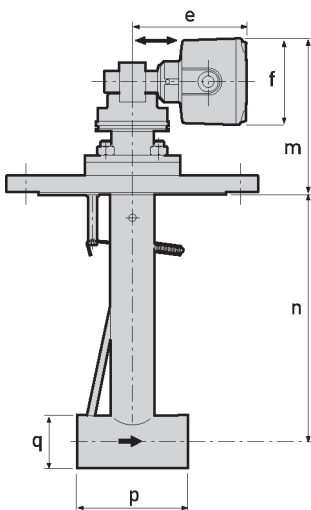

DW 184 Exd top view

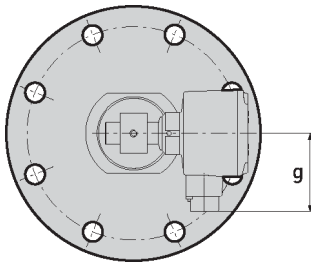

DW 184 HT side view

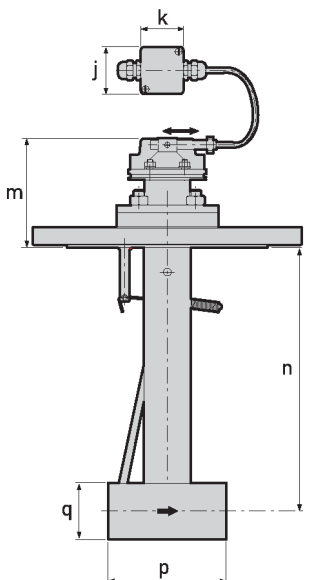

DIN 2526 flanges		Dimensions [mm]							Weight [kg]
DN [mm]	PN [bar]	e	f	g	m	n	p	q	
150 ①	16 / 40	130	Ø98	90	180	280	125	Ø60	14.2

① mounting flange size for DW 184 insertion-type flow controller. For process pipe diameters ≥ 250 mm.

ANSI B16.5 flanges		Dimensions [inches]							Weight [lbs]
NPS [inches]	Rating class [lbs]	e	f	g	m	n	p	q	
6 ①	150 / 300	5.1	Ø3.9	3.5	7.1	11.0	4.9	Ø2.4	31.2

① mounting flange size for DW 184 insertion-type flow controller. For process pipe diameters ≥ 10 inches.

DIN 2526 flanges		Dimensions [mm]						Weight [kg]
DN [mm]	PN [bar]	j	k	m	n	p	q	
150 ①	16 / 40	50.4	45.4	116	280	125	Ø60	12.9

① mounting flange size for DW 184 insertion-type flow controller. For process pipe diameters ≥ 250 mm.

ANSI B16.5 flanges		Dimensions [inches]						Weight [lbs]
NPS [inches]	Rating class [lbs]	j	k	m	n	p	q	
6 ①	150 / 300	2.0	1.8	4.6	11.0	4.9	Ø2.4	28.4

① mounting flange size for DW 184 insertion-type flow controller. For process pipe diameters ≥ 10 inches.





KROHNE Product Overview

- Electromagnetic flowmeters
- Variable area flowmeters
- Mass flowmeters
- Ultrasonic flowmeters
- Vortex flowmeters
- Flow controllers
- Level measuring instruments
- Pressure gauges
- Temperature measuring instruments
- Water solutions & analysis
- Oil and gas turnkey solutions

Addresses:

Germany

Northern sales office

KROHNE Messtechnik GmbH & Co. KG
Bremer Str. 133
D-21073 Hamburg
Phone: +49 (0)40 767 3340
Fax: +49 (0)40 767 33412
nord@krohne.de
ZIP code: 10000 - 29999, 49000 - 49999

Western and middle sales office

KROHNE Messtechnik GmbH & Co. KG
Ludwig-Krohne-Straße
D-47058 Duisburg
Phone: +49 (0)203 301 416
Fax: +49 (0)203 301 10416
west@krohne.de
ZIP code: 30000 - 34999, 37000 - 48000, 50000 - 53999, 57000 - 59999, 98000 - 99999

Southern sales office

KROHNE Messtechnik GmbH & Co. KG
Landsberger Str. 392
D-81241 Munich
Phone: +49 (0)89 121 5620
Fax: +49 (0)89 129 6190
sued@krohne.de
ZIP code: 0 - 9999, 80000 - 89999, 90000 - 97999

Southwestern sales office

KROHNE Messtechnik GmbH & Co. KG
Rüdesheimer Str. 40
D-65239 Hochheim/Main
Phone: +49(0)6146) 827 30
Fax: +49 (0)6146 827 312
rhein-main@krohne.de
ZIP code: 35000 - 36999, 54000 - 56999, 60000 - 79999

Instrumentation and control equipment catalog

TABLAR Messtechnik GmbH
Ludwig-Krohne-Straße 5
D-47058 Duisburg
Phone: +49 (0)2 03 305 880
Fax: +49 (0)2 03 305 8888
kontakt@tablar.de www.tablar.de

KROHNE sales companies

International

Australia

KROHNE Australia Pty Ltd
Quantum Business Park 10/287
Victoria Rd Rydalmere NSW 2116
Phone: +61 2 8846 1700
Fax: +61 2 8846 1755
krohne@krohne.com.au

Austria

KROHNE Austria Ges.m.b.H.
Mödecenterstraße 14
A-1030 Vienna
Phone: +43 (0)1/203 45 32
Fax: +43 (0)1/203 47 78
info@krohne.at

Belgium

KROHNE Belgium N.V.
Brusselstraat 320
B-1702 Groot Bijgaarden
Phone: +32 (0)2 4 66 00 10
Fax: +32 (0)2 4 66 08 00
krohne@krohne.be

Brazil

KROHNE Conaut Controles
Automaticos Ltda.
Estrada Das Águas Espraiadas, 230
C.P. 56 06835 - 080 EMBU - SP
Phone: +55 (0)11-4785-2700
Fax: +55 (0)11 4785-2768
conaut@conaut.com.br

China

KROHNE Measurement Instruments
(Shanghai) Co. Ltd., (KMIC)
Room 1501
1033 Zhaojiajiang Road
Shanghai 200030
Phone: +86 21 6487 9611
Fax: +86 21 6438 7110
info@krohne-asia.com

Czech Republic

Krohne CZ, spol. s r.o.
Sobiesická 156
63800 Brno
Phone: +420 (0)545 242 627
Fax: +420 (0)545 220 093
brno@krohne.cz

France

KROHNE S.A.S.
Les Ors BP 98
F-26103 ROMANS Cedex
Phone: +33 (0)4 75 05 44 00
Fax: +33 (0)4 75 05 00 48
info@krohne.fr

Great Britain

KROHNE Ltd.
Rutherford Drive
Park Farm Industrial Estate
Wellingborough
Northants NN8 6AE
Phone: +44 (0)19 33 408 500
Fax: +44 (0)19 33 408 501
info@krohne.co.uk

CIS

Kanex KROHNE Engineering AG
Business-Centre Planeta
Office 404 ul.
Marxistskaja 3
109147 Moscow/Russia
Phone: +7 (0)095 911 7165
Fax: +7 (0)095 742 8873
krohne@dol.ru

India

Krohne Marshall Ltd.
A-34/35, M.I.D.C. Industrial Area,
H-Block
Pimpri Poona 411018
Phone: +91 (0)202 744 2020
Fax: +91 (0)202 744 2020
pcu@vsnl.net

Iran

KROHNE Liaison Office
North Sohrvardi Ave. 26,
Sarmad St., Apt. #9
Tehran 15539
Phone: +9821 8874 5973
Fax: +9821 8850 1268
krohne@krohneiran.com

Italy

KROHNE Italia Srl.
Via V. Monti 75
I-20145 Milan
Phone: +39 02 4300 661
Fax: +39 02 4300 6666
info@krohne.it

Korea

KROHNE Korea
Room 508 Miwon Bldg 43
Yoido-Dong Youngdeungpo-Ku
Seoul, Korea
Phone: 00-82-2-782-1900
Fax: 00-82-2-780-1749
krohnekorea@krohnekorea.com

Netherlands

KROHNE Nederland B.V.
Kerkeplaat 14
NL-3313 LC Dordrecht
Phone: +31 (0)78 630 6200
Fax: +31 (0)78 630 6405
Service Direct: +31 (0)78 630 6222
info@krohne.nl

Norway

KROHNE Norway A.S.
Ekholtveien 114
NO-1521 Moss
Phone: +47 (0)69 264 860
Fax: +47 (0)69 267 333
postmaster@krohne.no

Poland

KROHNE Polska Sp.z.o.o.
ul. Stary Rynek Oliwski 8a
80-324 Gdansk
Phone: +48 (0)58 520 9211
Fax: +48 (0)58 520 9212
info@krohne.pl

Switzerland

KROHNE AG
Uferstr. 90
CH-4019 Basel
Phone: +41 (0)61 638 30 30
Fax: +41 (0)61 638 30 40
info@krohne.ch

Singapore

Tokyo Keiso - KROHNE (Singapore)
Pte. Ltd.
14, International Business Park,
Jurong East
Chiyoda Building, #01-01/02
Singapore 609922
Phone: (65) 6567 4548
Fax: (65) 6567 9874
tksi@tokyokeiso-krohne.com.sg

Republic of South Africa

KROHNE Pty. Ltd.
Bushbock Close
Corporate Park South
Midrand, Gauteng
P.O. Box 2069
Midrand, 1685
Phone: +27 (0)11 314 1391
Fax: +27 (0)11 314 1681
midrand@krohne.co.za

Spain

I.I. KROHNE IBERIA, S.r.l.
Poligono Industrial Nilo
Calle Brasil, nº. 5
28806 Alcalá de Henares Madrid
Phone: +34 (0)91 883 2152
Fax: +34 (0)91 883 4854
krohne@krohne.es

USA

KROHNE, Inc.
7 Dearborn Road
Peabody, MA 01960
Phone: +1 (800) FLOWING
Phone: +1 (978) 535 6060 (in MA)
info@krohne.com

Representatives

Algeria
Argentina
Cameroon
Canada
Chile
Columbia
Croatia
Denmark
Ecuador
Egypt
Finland
Gabon
Ghana
Greece
Hong Kong
Hungary
Indonesia
Iran
Ireland
Israel
Ivory Coast
Japan
Jordan
Kuwait
Libya
Lithuania
Malaysia
Mauritius
Mexico
Morocco
New Zealand
Peru
Portugal
Romania
Saudi Arabia
Senegal
Slovakia
Slovenia
Sweden
Taiwan
Thailand
Tunisia
Turkey
Venezuela
Yugoslavia

Other countries

KROHNE Messtechnik GmbH & Co. KG
Ludwig-Krohne-Str. 5
D-47058 Duisburg
Phone: +49 (0)203 301 0
Fax: +49 (0)203 301 389
export@krohne.de