



OMNTEC
Advanced Tank Monitoring & Leak Detection

PROTEUS® Automatic Tank Gauging and Leak Detection System

Part Number: OEL8000IIX



Description

A brighter future in tank gauging and leak detection has arrived with the **PROTEUS** Series. Featuring advanced technology, versatility, scalability, and enhanced features like our 7-inch color touch screen. The **PROTEUS-X** Series can simultaneously monitor product levels, water levels, temperature, leaks, and much more in up to 40 tanks. The flexibility of **PROTEUS** makes it ideal for a variety of gauging and leak detection applications.

The OEL8000IIX accepts up to 64 of OMNTEC's Bright Eye (BX Series) sensors for distinguishing product from water or for simply detecting the presence of liquid. A distinct advantage of Bright Eye sensors is they are networked and utilize 4 wire bus technology.

PROTEUS does not require sensor or probe input modules, bringing ease to ordering and installation. A built-in microprocessor gives each sensor the ability to identify itself and its location, which is displayed along with alarm conditions on the **PROTEUS's** 7-inch color touch screen graphic display.

With OMNTEC's proven reliability, the **PROTEUS** offers an attractive, comprehensive, and user-friendly system that can open doors to endless possibilities.

OMNTEC Mfg., Inc. has been certified by DQS Inc. to ISO 9001:2015; Registration Number 10017970.

Features

- Accepts up to 40 magnetostrictive probes
- Accepts up to 64 Bright Eye sensors
- Sensors networked using state of the art 4 wire bus technology
- (1) RS-232 port
- (1) RS-485 port
- 7-inch color touch screen graphic display
- Large user-friendly icons
- Easy to read leak and level alarms
- SD memory card slot (for extended logging)
- CITLD upgradeable
- Modbus RTU & TCP upgradeable
- Ethernet / TCP/IP standard
- Built in web server
- E-mail / Text capability standard
- SIL rated operating system
- Remote display option
- Thermal printer option
- VLD Standard
- 3 built in programmable relays
- Up to 32 additional dry contact relays
- Flash based non-volatile memory for program storage (does not require a battery)
- Compatible with OMNTEC PC remote tank inventory monitoring

PROTEUS®
Automatic Tank Gauging and
Leak Detection System
Part No. OEL8000IIIX

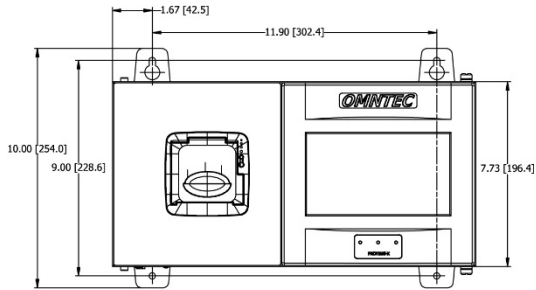

FRONT VIEW

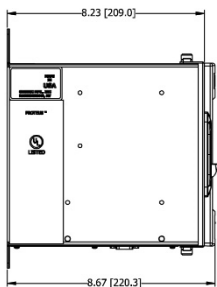

LEFT VIEW

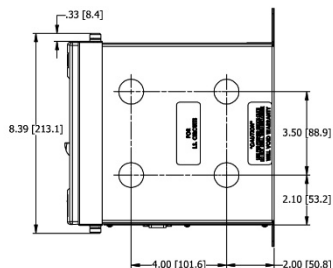



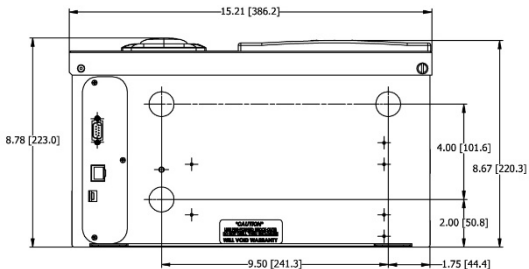

RIGHT VIEW

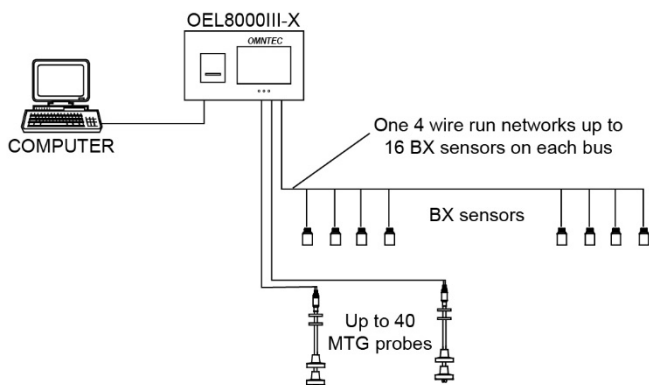

BOTTOM VIEW

OEL8000IIIX Application

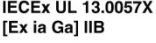

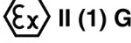
Specifications	
Optional Features:	36-character thermal printer Modbus RTU and TCP CITLD upgradeable OMNTEC PC software
Input Power:	100-240 VAC +/- 10% 50/60 Hz 50 watts (optional 12 VDC power)
Power to Sensors:	12 VDC @ 125 mA max
Power to Probe:	28 VDC
Audio Visual Controls:	
Display:	Color 7-inch graphic display with touch screen
Audible alarm:	85 dB piezoelectric horn
Printer:	36-character thermal
System status:	3 LED's (OK, fault, alarm)
Built In Relay Outputs:	120 VAC @ 0.6 amp resistive 3 SPST Failsafe
Low-voltage Output:	12 VDC @ 150 mA
Operating Temperature:	20 to 140° F (-7° to 60° C)
Compatible Sensors:	BX-Series sensors (refer to document no. 900106)
BX-Series Sensor Cable:	Shielded 22 AWG with drain wire (OMNTEC EC-4) Maximum length 2,000 feet (610m)
Compatible Probes:	Rigid Gauging Probe (refer to document no. 900194) MTG-4* (1219mm) MTG-6* (1829mm) MTG-8* (2438mm) MTG-10* (3048mm) Flexible Fixed Top Probe (refer to document no. 900166) MTG-F-* Series Flexible Fixed Bottom Probe (refer to document no. 900162) MTG-FB-* Series *Number signifies shaft length and corresponds to tank diameter. Contact representative for additional lengths.
MTG Probe Cable:	OMNTEC EC-2 (Shielded Belden #8761) Low Inductance: equal or less than 0.2 microhenries per ft. Maximum length 1,000 feet (305m) Consult representative for longer wire runs.
Accessories:	RD7CTS Mini-Me remote display DDL Series Delivery Defender Lite universal remote overfill alarm RAS Series Remote annunciators PS-103 Thermal printer DPU-C Thermal paper XB-416 4 probe 16 leak sensor output board XB-400 4 probe output board XB-RB8 8 relay output board rated at 5 amps 120 VAC C232-BAC Bacnet TCP/IP converter X232-420 External RS-232 to 4-20 ma converter
Weight:	20 lb. (9kg)
Dimensions:	(h) 7.75" (w) 15.25" (d) 8.78" Depth dimension includes printer and bezel
Approvals:	UL-listed & CUL-listed     DEMKO 13 ATEX 1341071X

Specifications subject to change without notice, verify with manufacturer.

OMNTEC
 2420 Pond Road
 Ronkonkoma, NY 11779
 +1.631.981.2001
 +1.631.981.2007
 omntec@omntec.com
 www.omntec.com